

CATÁLOGO

ALLIANCE IMPORT PARTS

2024



Alliance
IMPORT PARTS

SUMÁRIO

EATON

3

MERCEDES BENZ

6

SCANIA

11

VOLVO

12

ZF

16





JOGO DE REPARO

Peso: 0,357kg

Aplicações: Eaton
FTS 16108

ALL 108



JOGO DE REPARO

Peso: 0,314kg

Aplicações: Eaton
RT 11710

ALL 117

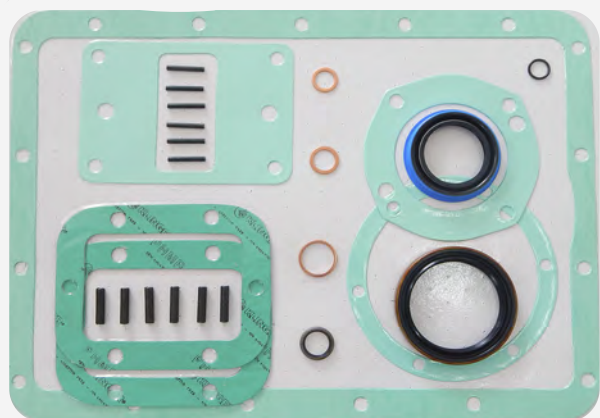

JOGO DE REPARO COM RETENTOR PILOTO 4300121

Peso: 0,398kg

Aplicações: Eaton
TRANSMISSÃO FS 6206

ALL 121

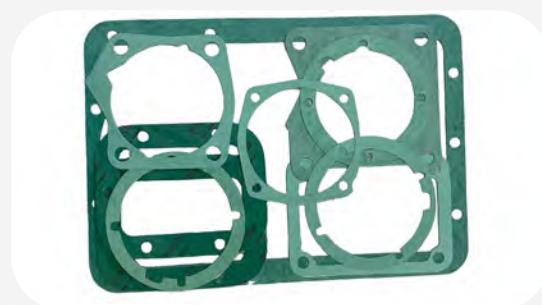

JOGO DE REPARO COM RETENTOR PILOTO

Peso: 0,325kg

Aplicações: Eaton
TRANSMISSÃO FS 4205

ALL 420



JOGO DE REPARO

Peso: 0,268kg

Aplicações: Eaton

FSO 4305
FSO 4405

ALL 440

JOGO DE REPARO

Peso: 0,288kg

Aplicações: Eaton

TRANSMISSÃO FSO 4505

ALL 450

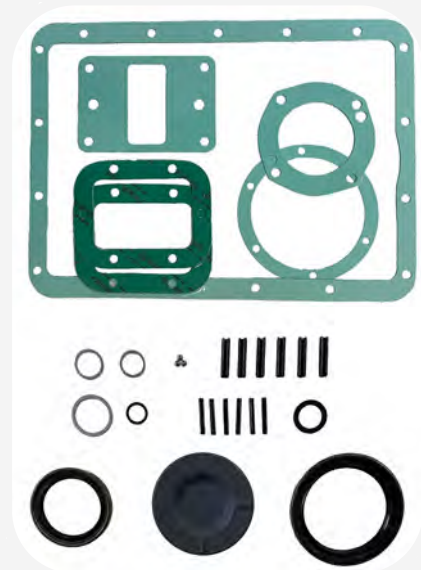

JOGO DE REPARO

Peso: 0,500kg

Aplicações: Eaton

RT 7608
RT 8609

ALL 608

JOGO DE REPARO
COMPLETO

Peso: 0,415kg

Aplicações: Eaton

TRANSMISSÃO FS 6306

ALL 630

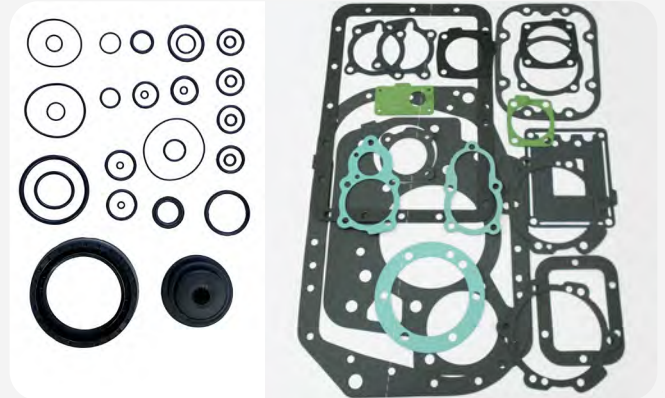

ALL 820

JOGO DE REPARO

Peso: 0,231kg

Aplicações: Eaton

FS 6209
FS 8209
FS 11109

ALL 890

JOGO DE REPARO

Peso: 0,357kg

Aplicações: Eaton

RT 8908
RT 12913
RT 14918

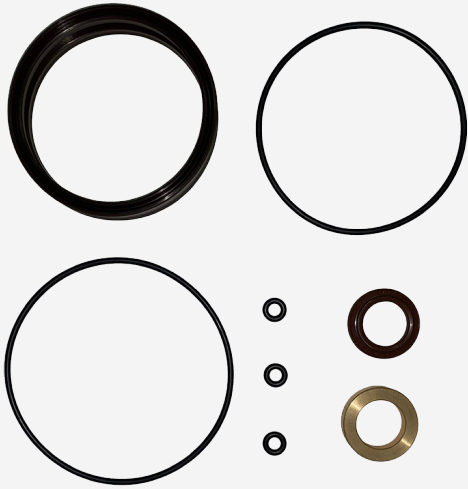

**JOGO DE REPARO DA
TRANSFERÊNCIA**

Peso: 0,070kg
Aplicações: Mercedes Benz - Atego - Axor
G 131 G 214 G 281
G 210 G 221 G 330
G 211 G 240

ALL 024



**JOGO DE REPARO
DA REDUZIDA**

Peso: 0,054kg
Aplicações: Mercedes Benz
G 210
G 240

ALL 025



**TAMPÃO LATERAL
9702610333**

Peso: 0,143kg
Aplicações: Mercedes Benz
G 60
G 85
GO 110

ALL 0333



**RETENTOR PILOTO
0239977847**

Peso: 0,020kg
Aplicações: Mercedes Benz
G 131 G 210 G 240 G 281 GO 210
G 141 G 211 G 241 G 330 GO 240
G 181 G 221 G 280 GO 190

ALL 0547



BUCHA DE BRONZE
3872670650

Peso: 0,038kg

Aplicações: Mercedes Benz

G 100 G 140 G 180 G 211 G 231 G 260 G 330
G 125 G 141 G 200 G 221 G 240 G 280 GO 210
G 135 G 155 G 210 G 230 G 241 G 281

ALL 0650

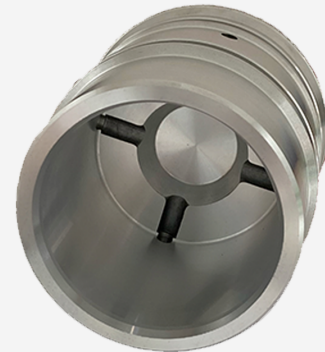

CILINDRO DA REDUZIDA G210/240
9452670819

Peso: 0,240kg

Aplicações: Mercedes Benz

G100 G210 G231 G260 G330
G140 G211 G240 G280
G200 G230 G241 G281

ALL 0819



JOGO DE REPARO

Peso: 0,353kg

Aplicações: Mercedes Benz

G 60
G 85

ALL 085



JOGO DE REPARO

Peso: 0,360kg

Aplicações: Mercedes Benz

G 60/ BUS
G 85/ BUS

ALL 085
BUS



ALL 131

JOGO DE REPARO

Peso: 0,200kg

Aplicações: Mercedes Benz - Atego
G 131

ALL 190

JOGO DE REPARO COMPLETO

Peso: 0,276kg

Aplicações: Mercedes Benz
GO 190
GO 210
ÔNIBUS O500

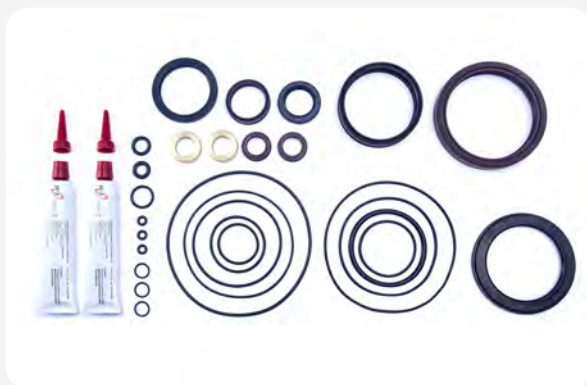

ALL 240

JOGO DE REPARO COMPLETO

Peso: 0,460kg

Aplicações: Mercedes Benz
G 210 G 281
G 221
G 240

ALL 330

JOGO DE REPARO

Peso: 0,375kg

Aplicações: Mercedes Benz
G 330



ALL 746

CONJUNTO TRAVA (BIGODE + BALA + MOLAS)
3879932101 - 3879932201 - 9452600073
9452680474 - 9452680746

Peso: 0,094kg

Aplicações: Mercedes Benz
G 240

ALL 1319

CILINDRO TRANSFERÊNCIA
9452671319

Peso: 0,610kg

Aplicações: Mercedes Benz
G 131 G 211 G 231
G 181 G 221 G 240
G 210 G 230 G 260



ALL 1647

RETENTOR TRASEIRO
0239971647

Peso: 0,079kg

Aplicações: Mercedes Benz

G 181 G 230 G 241 G 281
G 210 G 231 G 260 G 330
G 211 G 240 G 280

ALL 2646

RETENTOR DO EIXO PILOTO
0139972646

Peso: 0,031kg

Aplicações: Mercedes Benz

G 60
G 85
GO 110



RETENTOR TRASEIRO
0249972747

ALL 2747

Peso: 0,033kg
Aplicações: Mercedes Benz
G 60
G 85
GO 110



RETENTOR DO TRAMBULADOR
0219973747

ALL 3747

Peso: 0,012kg
Aplicações: Mercedes Benz
G 210
G 240



RETENTOR DO TRAMBULADOR
0209979247

ALL 9247

Peso: 0,010kg
Aplicações: Mercedes Benz
G 60
G 85



RETENTOR DO TRAMBULADOR
0002670197

ALL 0197

Peso: 0,007kg
Aplicações: Mercedes Benz
G 141 G 211 G 241 G 330
G 180 G 221 G 280 GO 210
G 210 G 240 G 281 GO 240

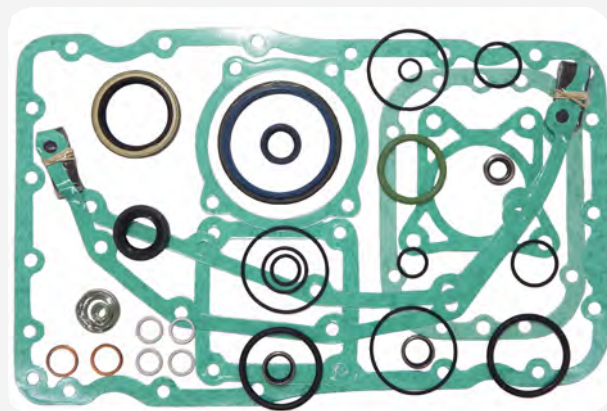
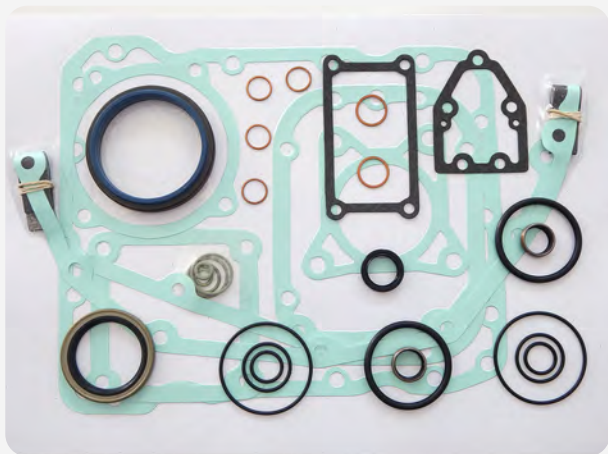

ALL 811

JOGO DE REPARO COMPLETO

Peso: 0,365kg

Aplicações: Scania

GR 801
GR 801R

ALL 900

JOGO DE REPARO COMPLETO

Peso: 0,380kg

Aplicações: Scania

GR 900 OPTICRUISE
GRS 900
GRSH 900

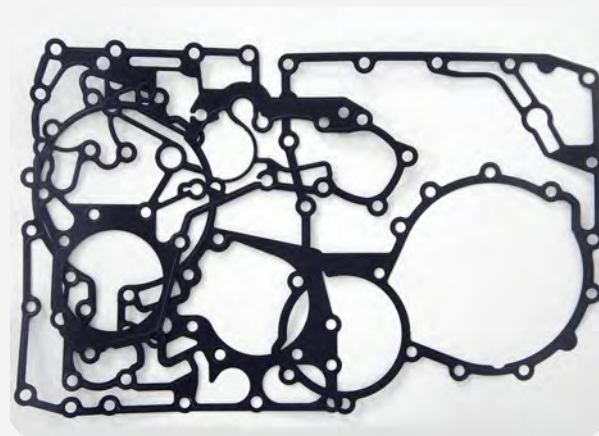

ALL 905

JOGO DE REPARO COMPLETO

Peso: 0,380kg

Aplicações: Scania

GRS 905 AUTOMATICA

ALL 925

**JOGO DE JUNTA
RETARDER AUTOMÁTICA**

Peso: 0,300kg

Aplicações: Scania

GR 875 GRS 905 GR SO 925
GR 905 GR SO 895
GRS 895 GR SO 905

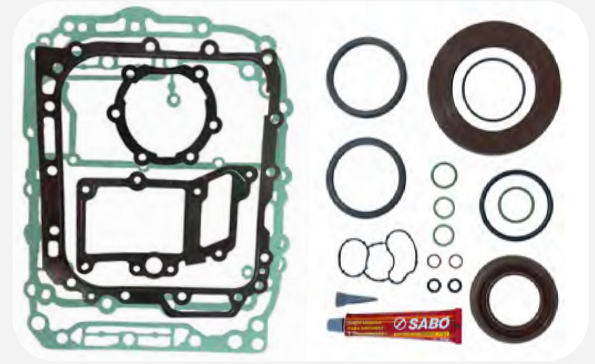
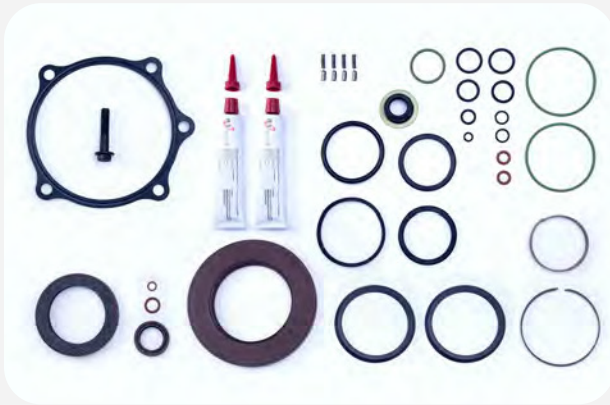

ALL 014

JOGO DE REPARO COMPLETO

Peso: 0,675kg

Aplicações: Volvo

VT 2014
VT 2214

ALL 512

JOGO DE REPARO (PAPEL/ METAL) COMPLETO

Peso: 0,385kg

Aplicações: Volvo

AT 2412 AT 3112 ATO 2812
AT 2512 ATO 2412 ATO 3112
AT 2812 ATO 2512 I-SHIFT



ALL 1305

RETENTOR DE SAÍDA DA CAIXA DE CÂMBIO
20791305

Peso: 0,105kg

Aplicações: Volvo

AT 2412 AT 2812 ATO 3112 VT 2214 VT 2514 OD VTO 2514
AT 2512 ATO 2512 ATO 3512 VT 2412 VT 2814 VTO 2814
AT 2612 ATO 2612 VT 2014 VT 2514 VTO 2214

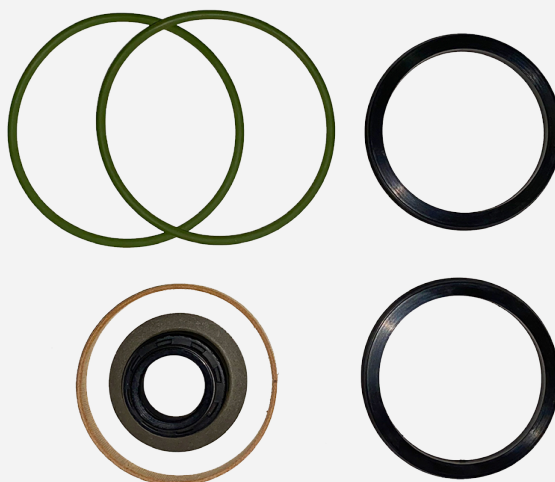

ALL 1976

CILINDRO DA REDUZIDA
1521976

Peso: 0,400kg

Aplicações: Volvo

VT 2214 VTO 2214
VT 2514 VTO 2514
VT 2814 VTO 2814

ALL 2575

KIT DA REDUZIDA
3092575

Peso: 0,041kg

Aplicações: Volvo

VT 2814 VT 2514 VTO 2514
VT 2014 VT 2514 OD VTO 2814
VT 2214 VTO 2214



ALL 2776

RETENTOR DE SAÍDA DA CAIXA DE CÂMBIO
1652776

Peso: 0,180kg

Aplicações: Volvo

AT 2412 AT 2812 ATO 3112 G 8 SR 1900 VT 2014 VT 2514 VTO 2214
AT 2512 ATO 2512 ATO 3512 SR 1400 VT 1708 VT 2214 VT 2514 OD VTO 2514
AT 2612 ATO 2612 G 7 SR 1700 VT 2009 VT 2412 VT 2814 VTO 2814

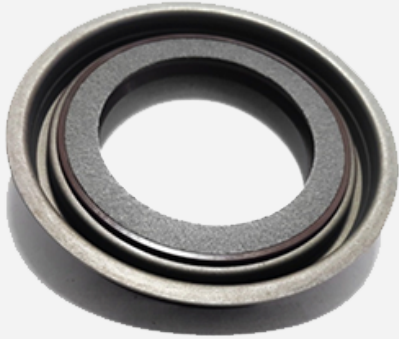

RETENTOR DO EIXO PILOTO
20483426

Peso: 0,073kg
Aplicações: Volvo
I-SHIFT AT 2612 ATO 2612
AT 2412 AT 2812 ATO 3112
AT 2512 ATO 2512 ATO 3512

ALL 3426



KIT PRESSIONADOR PINO + MOLA NEUTRO (4X)
1004057

Peso: 0,010kg
Aplicações: Volvo
VT 1708 VT 2214 VT 2814
VT 2009 VT 2514 VTO 2214
VT 2014 VT 2514 OD VTO 2814

ALL 4057



RETENTOR DE ENTRADA DA CAIXA DE CÂMBIO
20476025

Peso: 0,045kg
Aplicações: Volvo
VT 1708 VT 2214 VT 2514 OD VTO 2514
VT 2009 VT 2412 VT 2814 VTO 2814
VT 2014 VT 2514 VTO 2214

ALL 6025

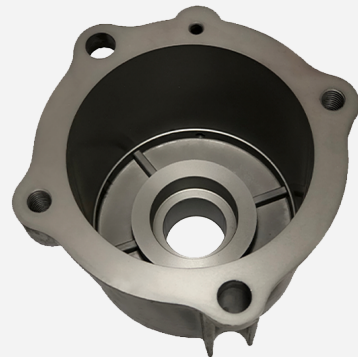

CILINDRO DA TRANSFERÊNCIA
1656239

Peso: 0,677kg
Aplicações: Volvo
VT 1708 VT 2214 VTO 2514
VT 2009 VT 2514
VT 2014 VTO 2214

ALL 6239

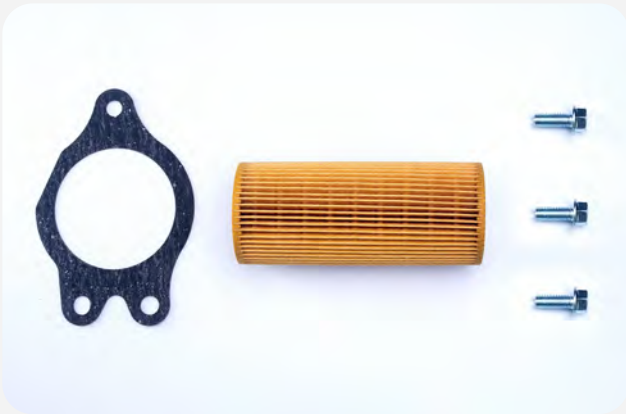

ALL 9106

FILTRO DO CÂMBIO
21479106

Peso: 0,204kg
Aplicações: Volvo
I-SHIFT

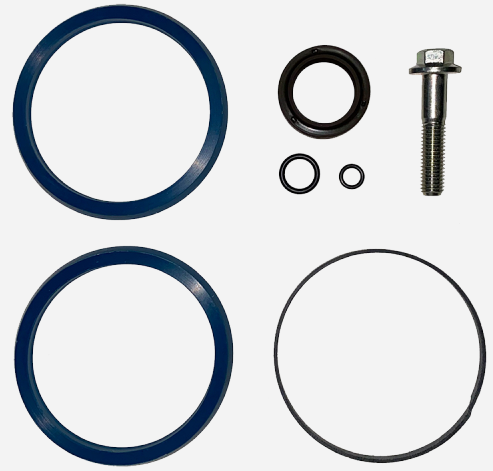

ALL 3230

REPARO DA TRANSFERÊNCIA
3092050 - 3093230

Peso: 0,077kg
Aplicações: Volvo
VT 1708 VT 2214 VTO 2214
VT 2009 VT 2514 VTO 2514
VT 2014 VT 2514 OD



ALL 514

JOGO DE REPARO COMPLETO

Peso: 0,470kg
Aplicações: Volvo
VT 2514
VT 2814

Marcas e Códigos Originais são utilizados somente como referência.

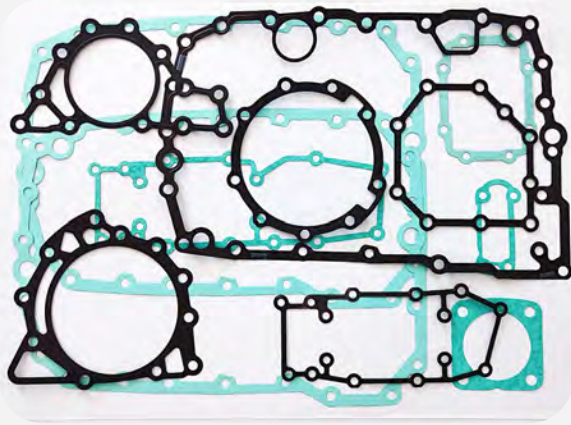

ALL 001

JOGO DE JUNTAS METAL/ PAPEL
1315298001

Peso: 0,254kg

Aplicações: ZF

16S 1585 16S 2280 16S 2520
16S 1685 16S 2320 16S 2525TD
16S 221 16S 2325 16S 2525TO



ALL 010

RETENTOR DE ÓLEO
0734310110

Peso: 0,043kg

Aplicações: ZF

16S 1300
8S 1350



ALL 011

RETENTOR
0734310111

Peso: 0,039kg

Aplicações: ZF

16S 1300 16S 1900
16S 1600
16S 1650



ALL 2015

CILINDRO DA REDUZIDA
1316312015

Peso: 0,675kg

Aplicações: ZF

16S 221
16S 228

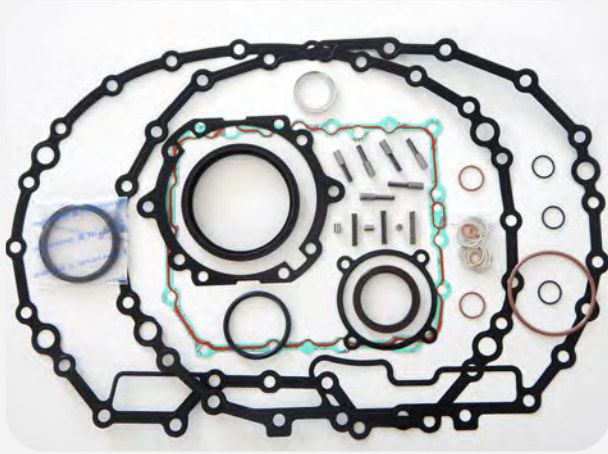

ALL 017

JOGO DE REPARO COM KIT PRESSONADOR
1328298017

Peso: 0,516kg

Aplicações: ZF
16AS 2230
16AS 2630

ALL 0253

RETENTOR
0734310253

Peso: 0,020kg

Aplicações: ZF
5S 580
5S 42
5S 420

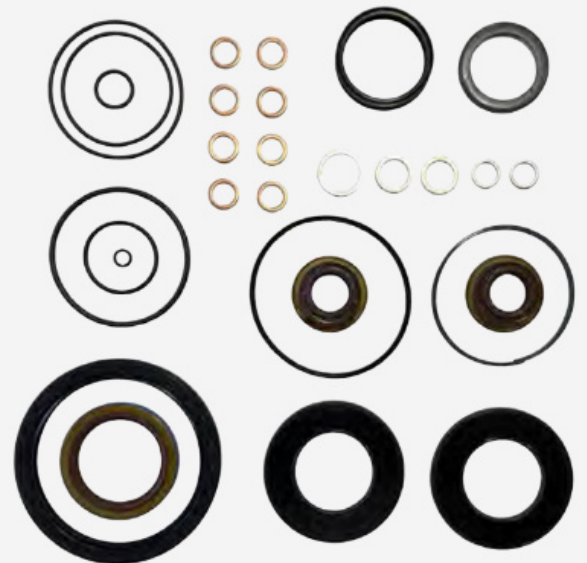

ALL 0387

RETENTOR DO CÂMBIO
0734310387

Peso: 0,030kg

Aplicações: ZF
16S 1585 16S 2180 16S 2280 16S 2520
16S 1685 16S 221 16S 2320 16S 2521
16S 2180 16S 2220 16S 2321 16S 2523

ALL 076

JOGO DE REPARO PARCIAL
1315298002 - 1315298076

Peso: 0,393kg

Aplicações: ZF
16S 221



ALL 077

REPARO DA TRANSFERÊNCIA
1315298077

Peso: 0,192kg

Aplicações: ZF

16S 221 16S 2520
16S 1685 16S 2525
16S 2280

ALL 078

REPARO DA REDUZIDA
1315298078

Peso: 0,042kg

Aplicações: ZF

16S 221 16S 2520
16S 1685 16S 2525
16S 2280

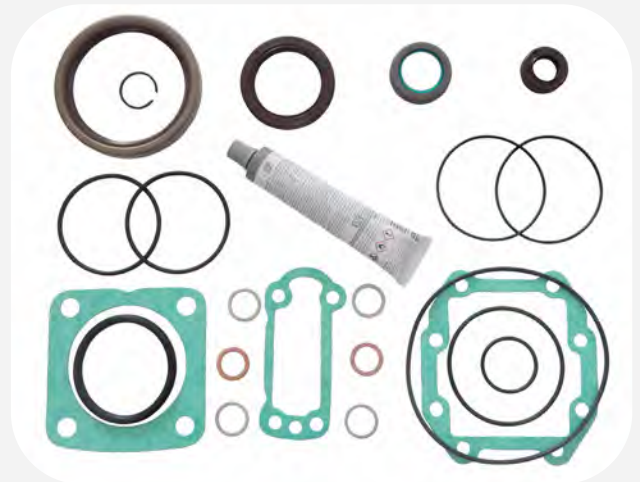
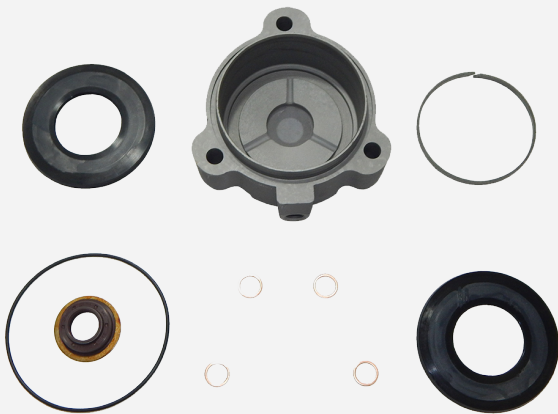

ALL 079

CILINDRO GP COM KITS
1304334079

Peso: 0,718kg

Aplicações: ZF
9S 1110

ALL 100

JOGO DE REPARO COMPLETO

Peso: 0,470kg

Aplicações: ZF

6AS 1000 6S 1000 BO
6AS 1000 BO
6S 1000

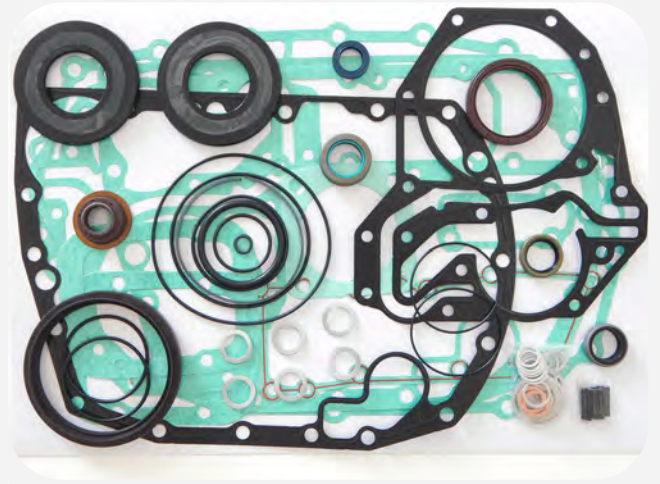

ALL 101

JOGO DE REPARO COM
KITS PRESSONADOR

Peso: 0,470kg

Aplicações: ZF
6AS 1000 BO
6S 1000 BO

ALL 110

JOGO DE REPARO
1324298010

Peso: 0,506kg

Aplicações: ZF
9S 1110



ALL 136

JOGO DE REPARO DA TRANSMISSÃO
COM KIT PRESSONADOR

Peso: 0,235kg

Aplicações: ZF
6S 450

ALL 145

JOGO DE REPARO

Peso: 0,470kg

Aplicações: ZF
16S 1455

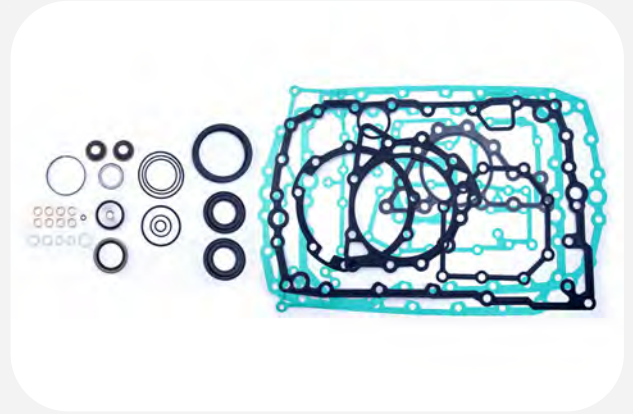
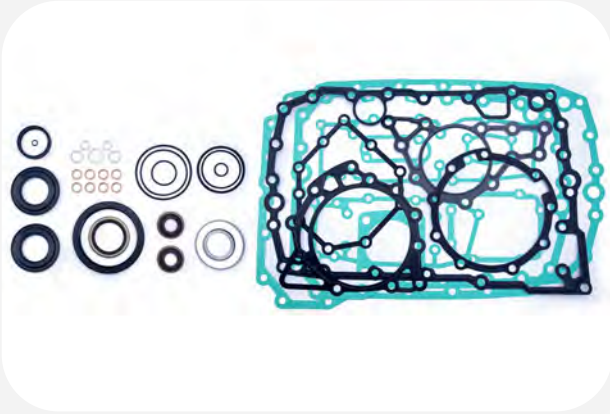

ALL 221

JOGO DE REPARO
1315298003

Peso: 0,633kg

Aplicações: ZF
16S 221 16S 2320
16S 1585
16S 1685

ALL 228

JOGO DE REPARO

Peso: 0,775kg

Aplicações: ZF
16S 221 16S 2280
16S 228
16S 1685

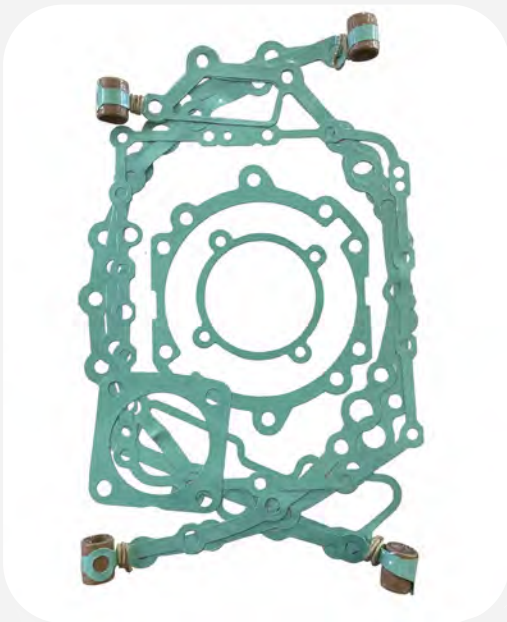

ALL 230

JOGO DE JUNTAS DA
TRANSMISSÃO

Peso: 0,122kg

Aplicações: ZF
ASTRONIC 12AS
ASTRONIC 16AS

ALL 300

JOGO DE REPARO
DA TRANSMISSÃO

Peso: 0,206kg

Aplicações: ZF
6S 300
6S 420

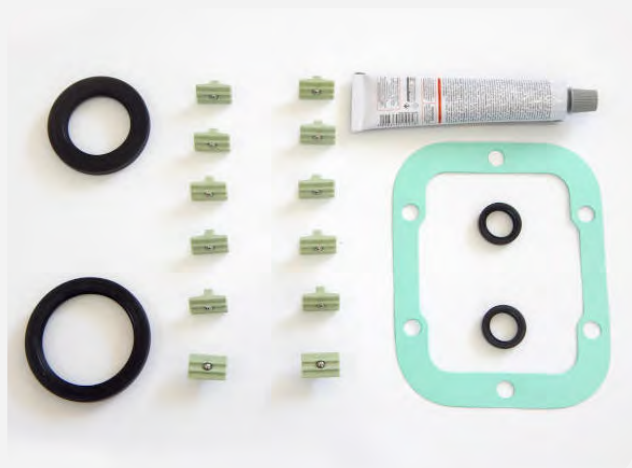

JOGO DE REPARO

ALL 480

Peso: 0,210kg

Aplicações: ZF
6S 480

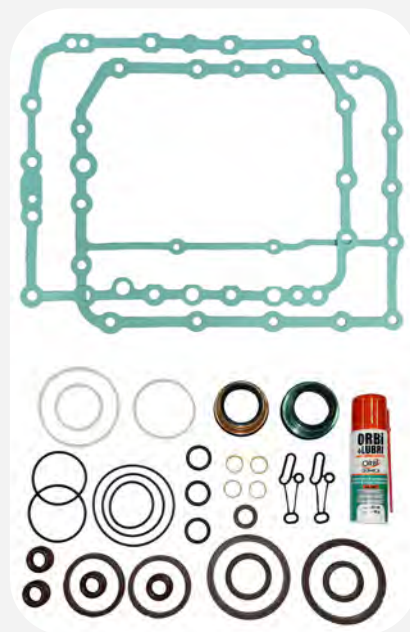

JOGO DE REPARO DO ATUADOR

ALL 609

Peso: 0,022kg

Aplicações: ZF
ASTRONIC 12AS
ASTRONIC 16AS

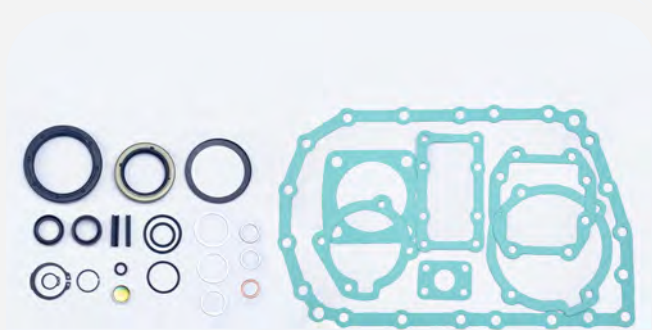

JOGO DE REPARO
1290298864 - 1290298865

ALL 680

Peso: 0,277kg

Aplicações: ZF
S5 680
S6 680

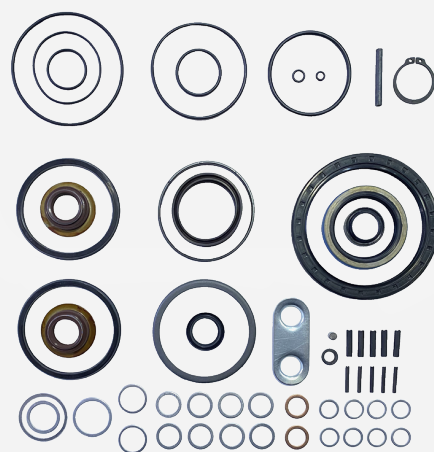

JOGO DE REPARO
1297298402

ALL 801

Peso: 0,470kg

Aplicações: ZF
8S 1350
16S 1650

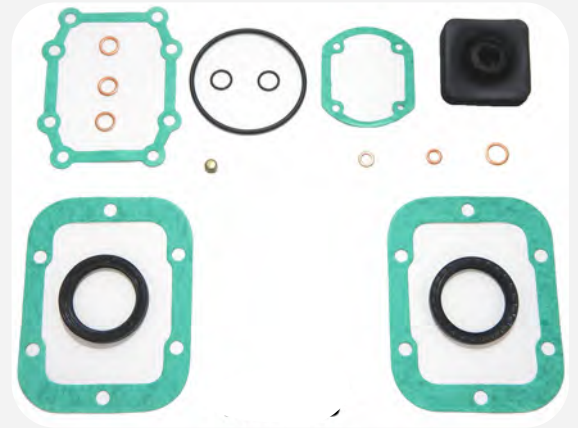
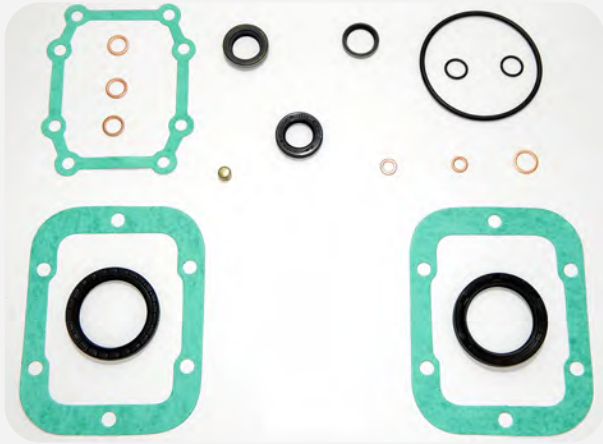

ALL 802

JOGO DE REPARO
1307298802

Peso: 0,227kg

Aplicações: ZF
S5-42

ALL 803

JOGO DE REPARO
SEM SINCRONIZAÇÃO
1307298803

Peso: 0,279kg

Aplicações: ZF
S5-42

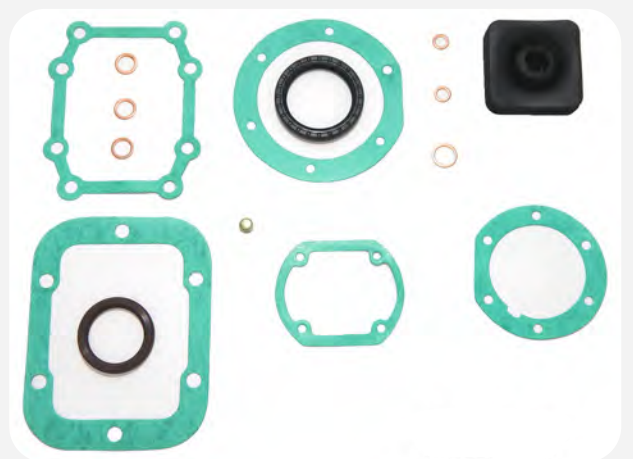
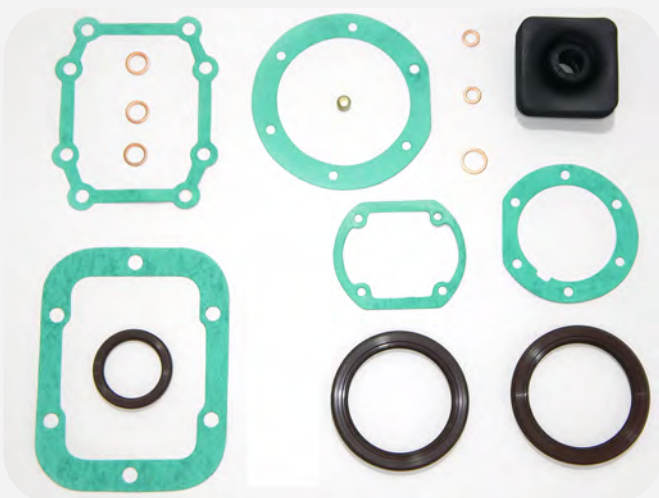

ALL 804

JOGO DE REPARO
1307298804

Peso: 0,329kg

Aplicações: ZF
S5 420
F 4000

ALL 806

JOGO DE REPARO
1307298806

Peso: 0,127kg

Aplicações: ZF
S5 420

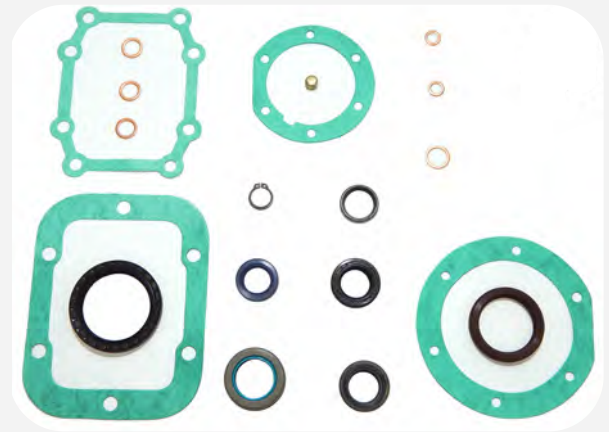
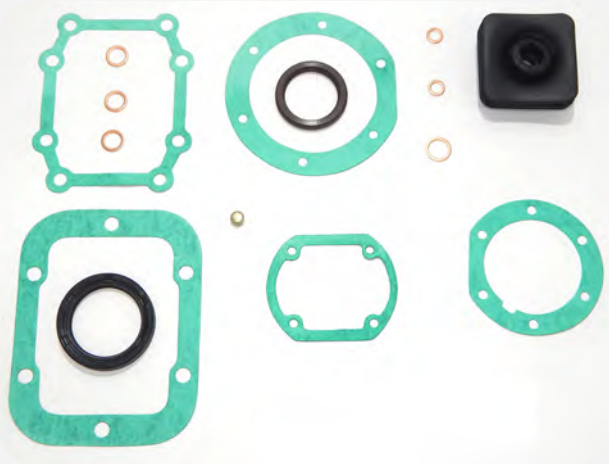

ALL 808

JOGO DE REPARO
1307298808

Peso: 0,131kg

Aplicações: ZF
S5 420

ALL 809

JOGO DE REPARO
1307298809

Peso: 0,218kg

Aplicações: ZF
S5 420

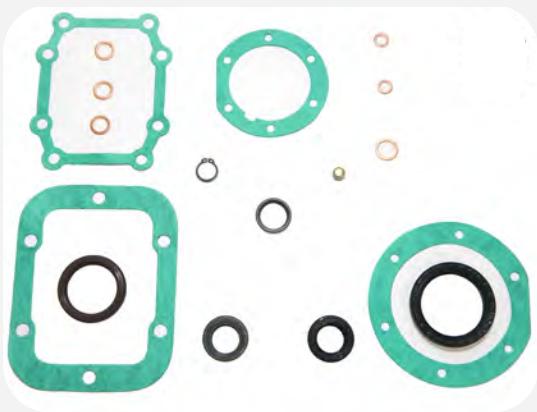

ALL 810

JOGO DE REPARO
1307298810

Peso: 0,219kg

Aplicações: ZF
S5 420

ALL 846

JOGO DE REPARO
1307298846

Peso: 0,267kg

Aplicações: ZF
S5 420

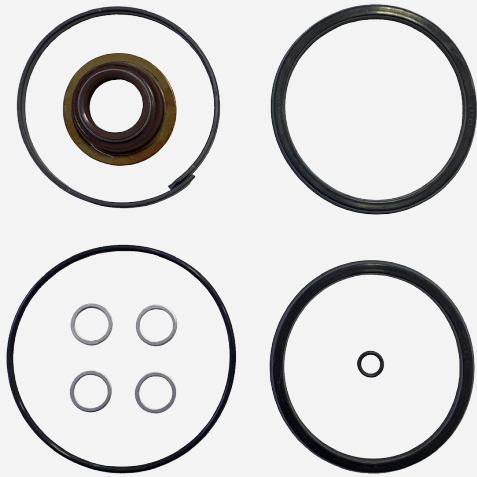

ALL 932

JOGO DE REPARO GP TRANSFERÊNCIA
1295298932
Peso: 0,051kg
Aplicações: ZF
16S 1300 16S 1900
16S 1600
16S 1650

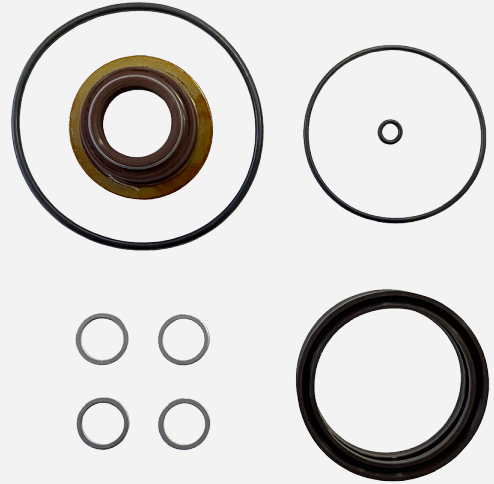

ALL 933

JOGO DE REPARO GV REDUZIDA
1295298933
Peso: 0,052kg
Aplicações: ZF
16S 1300 16S 1900
16S 1600
16S 1650

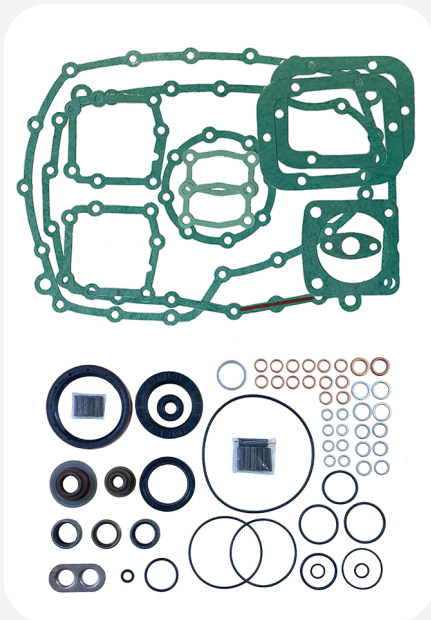

ALL 975

JOGO DE REPARO
1308298802
Peso: 0,395kg
Aplicações: ZF
9S 75



ALL 2034

RETENTOR DE ACIONAMENTO DO
GARFO (CHAPEU)
0750112034
Peso: 0,024kg
Aplicações: ZF
8S 1350
16S 1455
16S 1650



CILINDRO DA REDUZIDA
1296312042

Peso: 0,660kg

Aplicações: ZF
16S 1300 16S 1650
16S 1455 16S 1900
16S 1600

ALL 2042



RETENTOR DE ACIONAMENTO DO GARFO (CHAPEU)
0750112253

Peso: 0,025kg

Aplicações: ZF
16S 1585 16S 221 16S 2320 16S 2523
16S 1685 16S 2220 16S 2520 16S 2525
16S 2120 16S 2280 16S 2521

ALL 2253

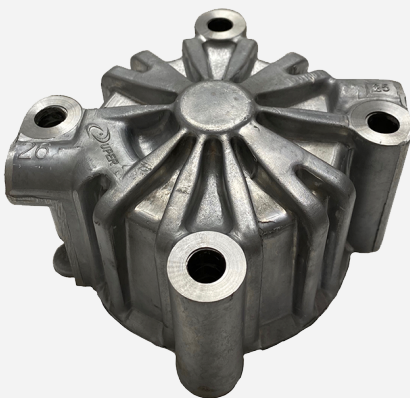

CILINDRO DA TRANSFERÊNCIA
1295334075

Peso: 0,830kg

Aplicações: ZF
16S 1300 16S 1650
16S 1455 16S 1900
16S 1600 8S 1350

ALL 4075



RETENTOR DO TRAMBULADOR
0634300302

Peso: 0,007kg

Aplicações: ZF
16S 1300 9S 1000 S5 820
16S 1600 9S 75 S6 680
16S 1650 S5 680 S6 90

ALL 0302



ANEL DE VEDAÇÃO

0734317150

Peso: 0,005kg

Aplicações: ZF

16S 1455

16S 1650

ALL 7150

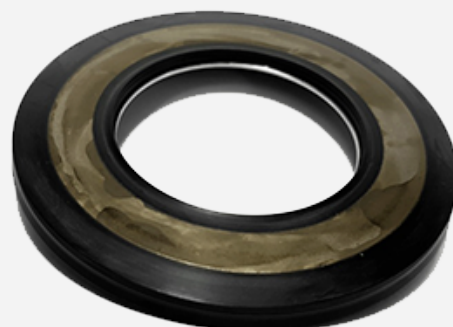

ANEL DE VEDAÇÃO

0734307294

Peso: 0,065kg

Aplicações: ZF

16S 1585 16S 2220 16S 2321 16S 2521

16S 1685 16S 2280 16S 2325 16S 2523

16S 221 16S 2320 16S 2520 16S 2525

ALL 7294



RETENTOR DO TRAMBULADOR

0634307367

Peso: 0,009kg

Aplicações: ZF

16S 1300 16S 1900 9S 75

16S 1600 6S 1000 S5 680

16S 1650 9S 1110 S6 680

ALL 7367



RETENTOR DO VELOCÍMETRO

0501398018

Peso: 0,001kg

Aplicações: ZF

16S 1650 S6 680

8S 1350 S6 820

S5 680 S6 90

ALL 8018



Marcas e Códigos Originais são utilizados somente como referência.

ALL 9551

RETENTOR
0734319551

Peso: 0,082kg

Aplicações: ZF

8S 190 16K 190 16S 150 16S 181 16S 220 16S 1301 16S 1820 TO 16S 1825 TO
16K 130 16S 112 16S 151 16S 190 16S 221 16S 1601 16S 1822 TO 16S 2220 TD
16K 160 16S 130 16S 160 16S 200 16S 1121 16S 1685 16S 1823 TO

16S 1900 9S 75
6S 1000 5S 680
9S 1110 5S 680

5S 680
5S 820
5S 90



Alliance

IMPORT PARTS

FAÇA UM ORÇAMENTO



*Marcas e Códigos Originais são utilizados somente como referência.

Rua José Rusconi Francisco 103 - Jardim do Paço - Sorocaba/ SP

contato@allianceimport.com.br

(15) 3228 - 3653