

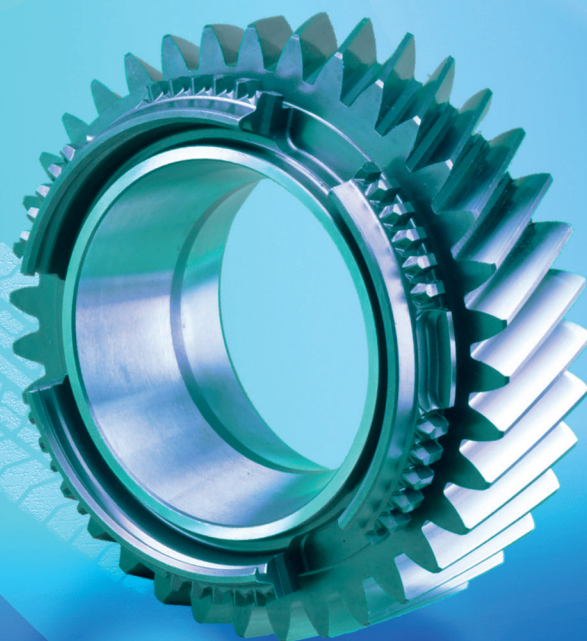

# GEARBOX AND DIFFERENTIAL SPARE PARTS



Gearbox and Differential  
spare parts suitable to:

**MERCEDES**  
**IMAGE CATALOGUE**





**GEARBOX AND DIFFERENTIAL**  
SPARE PARTS





## GEARBOX AND DIFFERENTIAL SPARE PARTS

T.A.S. is specialised in the manufacture and sale of **replacement spare parts** for the Automotive Aftermarket, such as bull gears, crown wheel and pinion sets (with straight and helical teeth), synchroniser assemblies with molybdenum or carbon coating, shafts, main drive gears and other components, suitable for **transmissions and differentials of light-duty vehicles, trucks, buses, agricultural tractors and earthmoving machinery.**

T.A.S. products are **totally interchangeable** with genuine parts from Mercedes, ZF, Renault Trucks, MAN, DAF, IVECO, Volvo, Dana, Scania, Meritor, Fuller Transmissions, Caterpillar, and many others, as they are made to the same high quality standards, thanks to modern technologies and to the continual specialisation of its staff.







Opening a TAS pack, you'll be astonished by its **explosive** content.

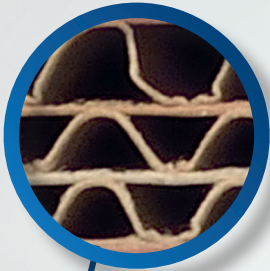

Tri-Wall corrugated cardboard box



Hardwood pallet compliant with IPPC ISPM 15









Our packaging is designed to ensure the **originality** and **integrity** of the product.



Tubular protective polyethylene nets



VCI Paper Sheets to prevent the onset of corrosion



TAS CODE  
**T88631**

QUANTITY  
001

BATCH NO.  
D18

WEIGHT  
0,417 Kg

OEM CODE  
**389 262 0637**

389 262 2537      389 262 2437

389 262 1137      389 262 1037

SYNCHRONIZER RING (MOLYBDENUM)

QUALITY PARTS  
MADE IN ITALY



Use your mobile phone to read the QR code that you find on the label.



You'll be directed to additional information on the TAS website.



SECURITY FOIL  
Moving DynaKey  
up and down  
"OK" is readable.



High-security OVD stripe for a reliable authentication of the product





Certifications

CERTIFICATO • CERTIFICADO • CERTIFICAT • CERTIFICATE • 認證證書 • ZERTIFIKAT

# CERTIFICATO

Nr 50 100 12205 - Rev. 01

Si attesta che / This is to certify that

IL SISTEMA QUALITÀ DI  
THE QUALITY SYSTEM OF



**T.A.S. (TRACTOR AUTOMOBILE SPARES) S.p.A.**

SEDE LEGALE E OPERATIVA:  
REGISTERED OFFICE AND OPERATIONAL SITE:  
**VIA ARGINE 306 I-80147 NAPOLI (NA)**

SEDE OPERATIVA:  
OPERATIONAL SITE:  
**VIA DELL'INDUSTRIA 1 I-40050 ARGELATO (BO)**

È CONFORME AI REQUISITI DELLA NORMA  
HAS BEEN FOUND TO COMPLY WITH THE REQUIREMENTS OF

**UNI EN ISO 9001:2015**

QUESTO CERTIFICATO È VALIDO PER IL SEGUENTE CAMPO DI APPLICAZIONE  
THIS CERTIFICATE IS VALID FOR THE FOLLOWING SCOPE

**Progettazione e fabbricazione di ingranaggi e organi di trasmissione per il settore automotive. Commercializzazione di componenti meccaniche nel settore automotive (IAF 18, 22, 29)**

**Design and manufacture of gears and transmission components for the automotive industry. Trade of mechanical components for the automotive industry (IAF 18, 22, 29)**



Per l'Organismo di Certificazione  
For the Certification Body  
**TUV Italia S.r.l.**

Validità / Validity

Dal / From: **2016-11-10**

Ai / To: **2019-10-20**

ISO 9001:2015  
SQA N° 0444 S6I N° 0550 IEP N° 0076  
SQA N° 0190 ITP N° 0241 LAB N° 0076  
SQA N° 0206 ISOE N° 0238 IRO N° 0016  
EMAS N° 033P PMS N° 0710  
Member of Accord 8: Motor Vehicle Parts  
EA IAF #142  
Signatory of EA IAF and IAC/AVMS  
Registration Agreement

*Andrea Coccia*  
**Andrea Coccia**  
Direttore Divisione Management Service

Data emissione / Printing Date  
**2016-11-10**

**PRIMA CERTIFICAZIONE / FIRST CERTIFICATION: 2013-10-21**

LA VALIDITÀ DEL PRESENTE CERTIFICATO È SOTTOPOSTA A SORVEGLIANZA PERIODICA A 12 MESI E AL RIESAME COMPLETO DEL SISTEMA DI GESTIONE AZIENDALE CON PERIODICITÀ TRIENNALE  
THE VALIDITY OF THE PRESENT CERTIFICATE IS DEPENDS ON THE ANNUAL SURVEILLANCE EVERY 12 MONTHS AND ON THE COMPLETE REVIEW OF COMPANY'S MANAGEMENT SYSTEM AFTER THREE-YEARS

TÜV Italia S.r.l. • Gruppo TÜV SÜD • Via Carducci 125, Pal. 23 • 20099 Sesto San Giovanni (MI) • Italia • www.tuv.it

OHSAS 18000



ISO 9001

ТАМОЖЕННЫЙ СОЮЗ



## СЕРТИФИКАТ СООТВЕТСТВИЯ

№ TC: **RU C-IT.A658.B.00936**

Серия RU № **0478352**

### ОРГАН ПО СЕРТИФИКАЦИИ

Орган по сертификации продукции "И-ФОНД": Общество с ограниченной ответственностью "Агентство по экспертизе и испытанию продукции". Адрес: 125167, РОССИЯ, город Москва, улица Восточная, дом 16, строения 1, флигельский адрес: 125319, РОССИЯ, город Москва, проспект Ленинградский, дом 84, строения 2, помещения № 501 на, 501-иБ, 507 н, 510 на, 510-иБ, 514 н. Телефон: +74951501658. Факс: +74951501658. E-mail: info@ifond.org. Аттестат аккредитации № RA.RU.11A.658 от 07.04.2016 года, выдан Федеральной службой по аккредитации.

### ЗАЯВИТЕЛЬ

Общество с ограниченной ответственностью «Центр испытаний и экспертизы продукции» (представитель T.A.S. S.p.A. на основании договора на выполнение функций изготовителя), 141280, Россия, Московская область, город Ивантеевка, Саватворный проезд, дом 1, ОГРН: 10850358009143. телефон: +74957644595, факс: +74957644595, e-mail: ciier@inbox.ru

### ИЗГОТОВИТЕЛЬ

T.A.S. S.p.A.  
Via Argine 306, 80147 Naples, Италия (смотри приложение на бланке № 0301433)

### ПРОДУКЦИЯ

Уплотнители головок блока цилиндров, коллекторы, газобаллонной аппаратуры, уплотнительные кольца (смотри приложение на бланках №№ 0301434, 0301435), продукция изготовлена в соответствии с ТР ТС 018/2011 "О безопасности колесных транспортных средств".  
Серийный выпуск

### КОД ТН ВЭД ТС

8484200000, 8484900000

### СООТВЕТСТВУЕТ ТРЕБОВАНИЯМ

ТР ТС 018/2011 "О безопасности колесных транспортных средств"

### СЕРТИФИКАТ ВЫДАН НА ОСНОВАНИИ

- протокола испытаний № 16/76401 от 11.07.2016 испытательной лабораторией "СМ-ТЕСТ" (аттестат аккредитации № РОСС RU.0001.21MP23, срок действия по 10.09.2016).

### ДОПОЛНИТЕЛЬНАЯ ИНФОРМАЦИЯ

срок службы и условия хранения продукции согласно документации изготовителя

С 21.12.2016 ПО 20.12.2020 ВКЛЮЧИТЕЛЬНО



Исполнитель (уполномоченное лицо) органа по сертификации  
Эксперт (эксперт-аудитор) (эксперты (эксперты-аудиторы))

*A.M. Иванов*  
*В.В. Гаевский*

**A.M. Иванов**  
(инициалы, фамилия)  
**В.В. Гаевский**  
(инициалы, фамилия)





**TAS available catalogues**  
for the following production line

**MERCEDES**

*Full parts catalogue*

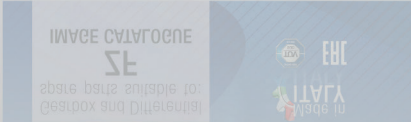

**SCANIA**

*Full parts catalogue*

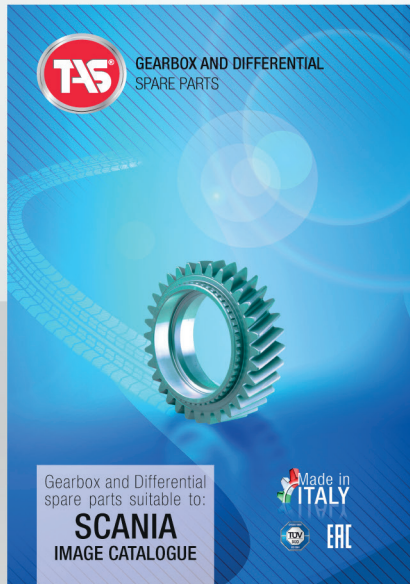

**VOLVO**

*Full parts catalogue*

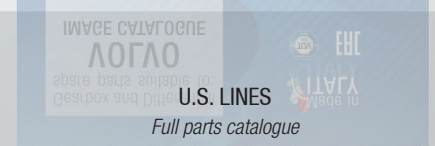



**GEARBOX AND DIFFERENTIAL**  
SPARE PARTS





T65192



**Description:**  
1ST SPEED GEAR

**Packaging Unit:** 1

**OEM No :**  
947 262 5310

**Model:**  
G211-12 Klauen  
G230-12 Klauen

**EX / CROSS :**  
947 262 5110  
948 262 0610

T15539



**Description:**  
1ST SPEED GEAR (38-44T.)

**Packaging Unit:** 1

**OEM No :**  
389 262 1611

**Model:**  
G155-16/11,9  
G155-16/14,0  
G180-16/11,9  
G180-16/14,0  
G200-16/11,9

**EX / CROSS :**  
389 262 1511

T17598



**Description:**  
1ST SPEED GEAR (38-44T.)

**Packaging Unit:** 1

**OEM No :**  
389 262 0411

**Model:**  
G155-16/11,9  
G155-16/14,0  
G180-16/11,9  
G180-16/14,0

**EX / CROSS :**

T08192



**Description:**  
1ST SPEED GEAR (39-45T.)

**Packaging Unit:** 1

**OEM No :**  
322 262 0511

**Model:**  
G3/36-5/8,98  
G3/40-5/7,5  
G3/40-5/7,5 Indonesian

**EX / CROSS :**  
322 262 0211

T65223



**Description:**  
1ST SPEED GEAR (40T.)

**Packaging Unit:** 1

**OEM No :**  
947 262 1911

**Model:**  
G131-9  
G141-9

**EX / CROSS :**  
947 262 1611



T38826



**Description:**

1ST SPEED GEAR (41-30T.)

**Packaging Unit:** 1

**OEM No :**

930 262 0511

**Model:**

G281-12 Klauen  
G330-12/11,64-0,78

**EX / CROSS :**

930 262 0811

948 262 0011

T63230



**Description:**

1ST SPEED GEAR (41-44T.)

**Packaging Unit:** 1

**OEM No :**

945 262 2711

**Model:**

G181-9  
G221-9/10,19-1,00

**EX / CROSS :**

945 262 2911

945 262 2311

T17375



**Description:**

1ST SPEED GEAR (44-44T.)

**Packaging Unit:** 1

**OEM No :**

389 262 2711

**Model:**

G210-16/14,2-0,83  
G211-16/17,03-1,0  
G230-16/14,2-0,83  
G231-16/17,03-1,0  
G240-16/11,72-0,69  
G260-16/9,75-0,57

**EX / CROSS :**

945 262 3111

389 262 2011

T59115



**Description:**

1ST SPEED GEAR (50-44T.)

**Packaging Unit:** 1

**OEM No :**

389 262 3311

**Model:**

GO170-6/8,2-1,0  
GO190-6/8,2-1,0  
GO210-6/6,53-0,80  
GO230-6/6,5-0,8

**EX / CROSS :**

389 262 3411

389 262 2511

T69317

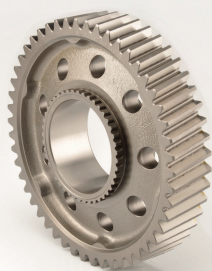

**Description:**

1ST SPEED GEAR (50-44T.)

**Packaging Unit:** 1

**OEM No :**

656 262 0211

**Model:**

GO210-6/6,53-0,80

**EX / CROSS :**





**T45580**



**Description:**

1ST SPEED GEAR (50-46T.)

**Packaging Unit: 1**

**OEM No :**

976 262 1411

**Model:**

G60-6/9,20-1,00  
G85-6/6,70-0,83

**EX / CROSS :**

975 262 0111

970 262 0511

970 262 0311

695 262 0011

**T94352**



**Description:**

1ST SPEED GEAR (50T.)

**Packaging Unit: 1**

**OEM No :**

656 262 0111

**Model:**

GO240-8/6,57-0,63  
GO250-8/6,57-0,63

**EX / CROSS :**

**T55055**



**Description:**

1ST SPEED GEAR (50T.) W/CONE (57-46T.)

**Packaging Unit: 1**

**OEM No :**

970 260 0344

**Model:**

G60-6/9,20-1,00

**EX / CROSS :**

970 260 3644

**T65271**

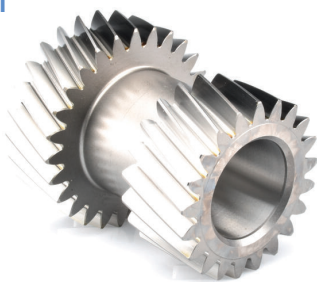

**Description:**

1ST-2ND SPEED GEAR CNTRSHFT (21-27T.)

**Packaging Unit: 1**

**OEM No :**

947 263 0111

**Model:**

G131-9  
G141-9

**EX / CROSS :**

**T40155**



**Description:**

2ND SPEED GEAR (23T.) W/SENSOR

**Packaging Unit: 1**

**OEM No :**

TAS40155

**Model:**

G211-12 Klauen  
G230-12 Klauen

**EX / CROSS :**

947 263 0112

947 263 0212

947 263 0512



T57277



**Description:**

2ND SPEED GEAR (23T.) W/OUT SENSOR

**Packaging Unit:** 1

**OEM No :**

930 263 0112/GEAR

**Model:**

**EX / CROSS :**

T16894



**Description:**

2ND SPEED GEAR (30-60T.)

**Packaging Unit:** 1

**OEM No :**

387 262 1813

**Model:**

G4/95-6/9,0  
GO4/95-5/5,1  
GV4/110-6/9,0

**EX / CROSS :**

T16905



**Description:**

2ND SPEED GEAR (32-44T.)

**Packaging Unit:** 1

**OEM No :**

389 262 1112

**Model:**

G125-16/14,0  
G135-16/11,9

**EX / CROSS :**

T12282



**Description:**

2ND SPEED GEAR (32-44T.)

**Packaging Unit:** 1

**OEM No :**

389 262 0312

**Model:**

G155-16/11,9  
G155-16/14,0  
G180-16/11,9  
G180-16/14,0

**EX / CROSS :**

389 262 0012

T12205



**Description:**

2ND SPEED GEAR (32-44T.)

**Packaging Unit:** 1

**OEM No :**

389 262 1312

**Model:**

G155-16/11,9  
G155-16/14,0  
G180-16/11,9  
G180-16/14,0  
G200-16/11,9

**EX / CROSS :**

389 262 1212





T08188



**Description:**  
2ND SPEED GEAR (32-45T.)

**Packaging Unit:** 1

**OEM No :**  
322 262 0412

**Model:**  
G3/36-5/8,98  
G3/40-5/7,5  
G3/40-5/7,5 Indonesian

**EX / CROSS :**  
322 262 0112  
321 262 0212

T15513



**Description:**  
2ND SPEED GEAR (32-48T.)

**Packaging Unit:** 1

**OEM No :**  
385 260 1444

**Model:**  
G3/65-8/9,29  
G3/65-9/13,36

**EX / CROSS :**

T08278



**Description:**  
2ND SPEED GEAR (32-48T.)

**Packaging Unit:** 1

**OEM No :**  
302 262 0312

**Model:**  
G3/50-5/8,5  
G3/50-5/8,5 Brazil  
G3/60-5/6,1  
G3/60-5/7,5  
G3/60-5/7,5 Brazil  
G3/61-5/6,1  
G3/61-5/6,1 Brazil

**EX / CROSS :**

T17267



**Description:**  
2ND SPEED GEAR (34-44T.)

**Packaging Unit:** 1

**OEM No :**  
389 262 1412

**Model:**  
G155-9/15,9  
GO210-8/11,8

**EX / CROSS :**

T55325



**Description:**  
2ND SPEED GEAR (36-44T.)

**Packaging Unit:** 1

**OEM No :**  
945 262 5912

**Model:**  
G181-9  
G221-9/10,19-1,00

**EX / CROSS :**  
945 262 6112  
945 262 0412



**T65325**



**Description:**  
2ND SPEED GEAR (36T.)

**Packaging Unit:** 1

**OEM No :**  
947 262 0612

**Model:**  
G131-9  
G141-9

**EX / CROSS :**  
947 262 0412  
947 262 2912

**T94349**



**Description:**  
2ND SPEED GEAR (36T.)

**Packaging Unit:** 1

**OEM No :**  
656 262 0212

**Model:**  
GO240-8/6,57-0,63  
GO250-8/6,57-0,63

**EX / CROSS :**

**T38824**



**Description:**  
2ND SPEED GEAR (38-30T.)

**Packaging Unit:** 1

**OEM No :**  
930 262 0112

**Model:**  
G281-12 Klauen  
G330-12/11,64-0,78

**EX / CROSS :**  
930 262 0612  
948 262 0212

**T65335**



**Description:**  
2ND SPEED GEAR (38T.)

**Packaging Unit:** 1

**OEM No :**  
947 262 2012

**Model:**

**EX / CROSS :**  
947 262 1012  
947 262 0912  
947 262 0812  
947 262 2412

**T17372**



**Description:**  
2ND SPEED GEAR (39-44T.)

**Packaging Unit:** 1

**OEM No :**  
945 262 3112

**Model:**

**EX / CROSS :**  
945 262 1712  
945 262 1612  
945 262 0812  
945 262 0712



**T58214**



**Description:**  
2ND SPEED GEAR (39T.)

**Packaging Unit:** 1

**OEM No :**  
945 262 6812

**Model:**  
G241-16 Klauen  
G280-16 Klauen

**EX / CROSS :**  
945 262 5612  
945 262 5512  
930 262 0312

**T59106**

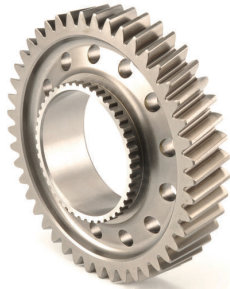

**Description:**  
2ND SPEED GEAR (45-44T.)

**Packaging Unit:** 1

**OEM No :**  
976 262 1612

**Model:**  
G100-12  
GO170-6/8,2-1,0  
GO190-6/8,2-1,0  
GO210-6/6,53-0,80  
GO230-6/6,5-0,8

**EX / CROSS :**  
976 262 1512  
389 262 2712

**T45584**



**Description:**  
2ND SPEED GEAR (45-58T.)

**Packaging Unit:** 1

**OEM No :**  
975 262 0112

**Model:**  
GO110-6/6,1-0,747

**EX / CROSS :**  
970 262 1612  
970 262 1312  
970 262 1012  
695 262 0112

**T61097**



**Description:**  
2ND SPEED GEAR (45T.) W/CONE (57-58T.)

**Packaging Unit:** 1

**OEM No :**  
970 260 2544

**Model:**  
G60-6/9,20-1,00

**EX / CROSS :**  
970 260 2244

**T08285**



**Description:**  
2ND-3RD SPEED GEAR CNTRSHFT (17-22T.)

**Packaging Unit:** 1

**OEM No :**  
307 263 0513

**Model:**  
G3/60-5/6,1  
G3/61-5/6,1  
G3/61-5/6,1 Brazil  
GO3/60-5/5,4  
GO3/60-5/5,4 Turkey

**EX / CROSS :**  
307 263 0413





T08335



**Description:**

2ND-3RD SPEED GEAR CNTRSHFT (17-22T.)

**Packaging Unit:** 1

**OEM No :**  
337 263 0713

**Model:**  
G3/60-5/6,1 Brazil

**EX / CROSS :**  
337 263 0513

T08203



**Description:**

2ND-3RD SPEED GEAR CNTRSHFT (17-23T.)

**Packaging Unit:** 1

**OEM No :**  
322 263 0513

**Model:**  
G3/36-5/8,98  
G3/40-5/7,5  
G3/40-5/7,5 Indonesian

**EX / CROSS :**  
322 263 0313  
322 263 0013

T82758



**Description:**

3RD SPEED & CONSTANT GEAR CNTRSHFT (30-36T.)

**Packaging Unit:** 1

**OEM No :**  
930 263 1310

**Model:**  
G281-12 Klauen

**EX / CROSS :**

T08185



**Description:**

3RD SPEED GEAR (25-45T.)

**Packaging Unit:** 1

**OEM No :**  
322 260 2444

**Model:**  
G3/36-5/8,98  
G3/40-5/7,5  
G3/40-5/7,5 Indonesian

**EX / CROSS :**  
322 260 1944

T94346



**Description:**

3RD SPEED GEAR (25T.)

**Packaging Unit:** 1

**OEM No :**  
656 262 0117

**Model:**  
GO240-8/6,57-0,63  
GO250-8/6,57-0,63

**EX / CROSS :**  
656 262 0917



T08293



**Description:**  
3RD SPEED GEAR (26-42T.)

**Packaging Unit:** 1

**OEM No :**  
314 260 3644

**Model:**  
G2/24-5/6,71  
G2/24-5/6,71 Brazil  
G2/24-5/7,31  
G2/24-5/7,31 Brazil

**EX / CROSS :**

T15514



**Description:**  
3RD SPEED GEAR (27-48T.)

**Packaging Unit:** 1

**OEM No :**  
385 260 1544

**Model:**  
G3/65-8/9,29  
G3/65-9/13,36

**EX / CROSS :**

T17265



**Description:**  
3RD SPEED GEAR (27-51T.)

**Packaging Unit:** 1

**OEM No :**  
389 262 1013

**Model:**  
G155-9/15,9  
GO210-8/11,8

**EX / CROSS :**

T15542



**Description:**  
3RD SPEED GEAR (28-44T.)

**Packaging Unit:** 1

**OEM No :**  
389 262 2113

**Model:**  
G155-16/11,9  
G155-16/14,0  
G180-16/11,9  
G180-16/14,0  
G200-16/11,9

**EX / CROSS :**

T08328



**Description:**  
3RD SPEED GEAR (28-45T.)

**Packaging Unit:** 1

**OEM No :**  
337 262 0713

**Model:**  
G3/60-5/6,1 Brazil

**EX / CROSS :**  
337 262 0313





**Description:**  
3RD SPEED GEAR (28-48T.)

**Packaging Unit:** 1

**OEM No :**  
302 260 1644

**Model:**  
G3/60-5/6,1  
G3/61-5/6,1

**EX / CROSS :**



**Description:**  
3RD SPEED GEAR (28-60T.)

**Packaging Unit:** 1

**OEM No :**  
389 262 0713

**Model:**  
G125-16/14,0  
G135-16/11,9

**EX / CROSS :**



**Description:**  
3RD SPEED GEAR (28-60T.)

**Packaging Unit:** 1

**OEM No :**  
389 262 1413

**Model:**  
G155-16/11,9  
G155-16/14,0  
G180-16/11,9  
G180-16/14,0

**EX / CROSS :**  
389 262 1313  
389 262 0913  
389 262 0813



**Description:**  
3RD SPEED GEAR (28-60T.)

**Packaging Unit:** 1

**OEM No :**  
389 262 0313

**Model:**  
G155-16/11,9  
G155-16/14,0  
G180-16/11,9  
G180-16/14,0

**EX / CROSS :**  
389 262 0013



**Description:**  
3RD SPEED GEAR (29T.)

**Packaging Unit:** 1

**OEM No :**  
930 262 0513

**Model:**  
G280-16 Klauen

**EX / CROSS :**  
930 262 0213  
930 262 0113  
930 262 0013



T65433



**Description:**  
3RD SPEED GEAR (31T.)

**Packaging Unit:** 1

**OEM No :**  
947 262 0613

**Model:**  
G131-9  
G141-9

**EX / CROSS :**  
947 262 0413

T51534



**Description:**  
3RD SPEED GEAR (32-51T.)

**Packaging Unit:** 1

**OEM No :**  
945 262 1617

**Model:**  
G181-9  
G221-9/10,19-1,00

**EX / CROSS :**  
945 262 1913  
945 262 1313

T18854



**Description:**  
3RD SPEED GEAR (34-44T.)

**Packaging Unit:** 1

**OEM No :**  
945 262 3513

**Model:**

**EX / CROSS :**  
945 262 1813

T15518



**Description:**  
3RD SPEED GEAR (34-60T.)

**Packaging Unit:** 1

**OEM No :**  
389 262 1813

**Model:**  
G210-16/14,2-0,83

**EX / CROSS :**

T58210



**Description:**  
3RD SPEED GEAR (34T.)



**Packaging Unit:** 1

**OEM No :**  
930 262 0613

**Model:**  
G241-16 Klauen

**EX / CROSS :**  
930 262 0413  
945 262 9713  
945 262 9613



<p><b>T53137</b></p> 	<p><b>Description:</b> 3RD SPEED GEAR (40-48T.)</p> <p><b>OEM No :</b> 945 262 6417</p> <p><b>EX / CROSS :</b></p>	<p><b>Packaging Unit:</b> 1</p> <p><b>Model:</b> GO170-6/8,2-1,0 GO190-6/8,2-1,0 GO210-6/6,53-0,80 GO230-6/6,5-0,8</p>
<p><b>T53132</b></p> 	<p><b>Description:</b> 3RD SPEED GEAR (40-54T.)</p> <p><b>OEM No :</b> 656 262 4413</p> <p><b>EX / CROSS :</b> 656 262 0013 389 262 4413 389 262 4313 389 262 3613</p>	<p><b>Packaging Unit:</b> 1</p> <p><b>Model:</b> GO170-6/8,2-1,0 GO190-6/8,2-1,0 GO230-6/6,5-0,8</p>
<p><b>T45574</b></p> 	<p><b>Description:</b> 3RD SPEED GEAR (47-44T.)</p> <p><b>OEM No :</b> 975 262 0113</p> <p><b>EX / CROSS :</b> 970 262 1213 970 262 1113 694 262 0013</p>	<p><b>Packaging Unit:</b> 1</p> <p><b>Model:</b> GO110-6/6,1-0,747</p>
<p><b>T19666</b></p> 	<p><b>Description:</b> 3RD SPEED GEAR (47-60T.)</p> <p><b>OEM No :</b> 976 262 1113</p> <p><b>EX / CROSS :</b> 976 262 1013 976 262 0913 976 262 0713 976 262 0113</p>	<p><b>Packaging Unit:</b> 1</p> <p><b>Model:</b> G100-12 GO4/160-6/8,2</p>
<p><b>T55339</b></p> 	<p><b>Description:</b> 3RD SPEED GEAR CNTRSHFT (31-35T.)</p> <p><b>OEM No :</b> 945 263 1813</p> <p><b>EX / CROSS :</b> 945 263 1913 945 263 1213</p>	<p><b>Packaging Unit:</b> 1</p> <p><b>Model:</b> G221-9/10,19-1,00</p>

**T15550**



**Description:**

3RD-4TH SPEED GEAR CNTRSHFT (21-25T.)

**Packaging Unit:** 1

**OEM No :**

389 263 1013

**Model:**

G155-16/11,9  
G155-16/14,0  
G180-16/11,9  
G180-16/14,0

**EX / CROSS :**

389 263 0913

**T17271**



**Description:**

3RD-4TH SPEED GEAR CNTRSHFT (24-28T.)

**Packaging Unit:** 1

**OEM No :**

389 263 1113

**Model:**

G155-9/15,9  
GO210-8/11,8

**EX / CROSS :**

**T12233**



**Description:**

3RD-4TH SPEED GEAR CNTRSHFT (25-21T.)

**Packaging Unit:** 1

**OEM No :**

389 263 1413

**Model:**

G155-16/11,9  
G155-16/14,0  
G180-16/11,9  
G180-16/14,0  
G200-16/11,9

**EX / CROSS :**

**T17384**



**Description:**

3RD-4TH SPEED GEAR CNTRSHFT (29-34T.)

**Packaging Unit:** 1

**OEM No :**

945 263 3213

**Model:**

**EX / CROSS :**

945 263 0013

945 263 1713

389 263 1813

**T65479**



**Description:**

3RD-4TH SPEED GEAR CNTRSHFT (32-38T.)

**Packaging Unit:** 1

**OEM No :**

947 263 0413

**Model:**

G131-9  
G141-9

**EX / CROSS :**

947 263 0513





**T45239**



**Description:**

3RD-4TH SPEED GEAR CNTRSHFT (33-38T.)

**Packaging Unit:** 1

**OEM No :**  
970 263 0713

**Model:**  
G60-6/9,20-1,00  
G85-6/6,70-0,83  
GO110-6/6,1-0,747

**EX / CROSS :**  
975 263 0113  
694 263 0013  
970 263 0613

**T18859**



**Description:**

3RD-4TH SPEED GEAR CNTRSHFT (34-27T.)

**Packaging Unit:** 1

**OEM No :**  
945 263 2913

**Model:**

**EX / CROSS :**

**T94360**



**Description:**

3RD-4TH SPEED GEAR CNTRSHFT (34-41T.)

**Packaging Unit:** 1

**OEM No :**  
656 263 0410

**Model:**  
GO240-8/6,57-0,63  
GO250-8/6,57-0,63

**EX / CROSS :**

**T53146**



**Description:**

3RD-4TH SPEED GEAR CNTRSHFT (38-28T.)

**Packaging Unit:** 1

**OEM No :**  
656 263 0013

**Model:**  
GO170-6/8,2-1,0  
GO190-6/8,2-1,0  
GO210-6/6,53-0,80  
GO230-6/6,5-0,8

**EX / CROSS :**  
389 263 3013  
389 263 2713

**T44033**



**Description:**

3RD-4TH SPEED GEAR CNTRSHFT (38-33T.)

**Packaging Unit:** 1

**OEM No :**  
389 263 2113

**Model:**  
G100-12  
GO4/160-6/8,2

**EX / CROSS :**



**Description:** 4661 FULL KIT ASSEMBLY + OIL PUMP **Packaging Unit:** 1

**OEM No :** TAS52215 **Model:** G240-16/11,72-0,69  
G330-12/11,64-0,78

**EX / CROSS :**



**Description:** 4661 FULL KIT ASSEMBLY W/O OIL PUMP **Packaging Unit:** 1

**OEM No :** TAS52216 **Model:** G240-16/11,72-0,69  
G330-12/11,64-0,78

**EX / CROSS :**

TAS60607



**Description:** 4TH SPEED GEAR (19-45T.) **Packaging Unit:** 1

**OEM No :** 322 260 2044 **Model:** G3/36-5/8,98  
G3/40-5/7,5

**EX / CROSS :**

322 260 1744



**Description:** 4TH SPEED GEAR (21-42T.) **Packaging Unit:** 1

**OEM No :** 314 260 2444 **Model:** G2/24-5/6,71  
G2/24-5/6,71 Brazil  
G2/24-5/7,31  
G2/24-5/7,31 Brazil

**EX / CROSS :**

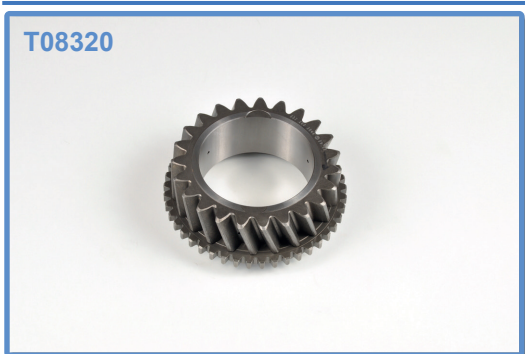

**Description:** 4TH SPEED GEAR (23-45T.) **Packaging Unit:** 1

**OEM No :** 337 260 3044 **Model:** G3/60-5/6,1 Brazil

**EX / CROSS :**

337 260 2744



**T08322**



**Description:**  
4TH SPEED GEAR (23-48T.)

**Packaging Unit:** 1

**OEM No :**  
337 260 3144

**Model:**  
G3/60-5/6,1  
G3/61-5/6,1

**EX / CROSS :**  
307 260 4244  
307 260 3544  
307 260 1644

**T16898**



**Description:**  
4TH SPEED GEAR (24-51T.)

**Packaging Unit:** 1

**OEM No :**  
387 262 3814

**Model:**  
G4/110-6/9,0  
GO4/110-5/5,1  
GV4/95-6/9,0

**EX / CROSS :**  
387 262 2114

**T94336**



**Description:**  
4TH SPEED GEAR (24T.)

**Packaging Unit:** 1

**OEM No :**  
656 262 0910

**Model:**  
GO240-8/6,57-0,63  
GO250-8/6,57-0,63

**EX / CROSS :**

**T15534**



**Description:**  
4TH SPEED GEAR (29-36T.)

**Packaging Unit:** 1

**OEM No :**  
389 260 5719

**Model:**  
G240-16/11,72-0,69

**EX / CROSS :**  
389 262 2013

**T18841**



**Description:**  
4TH SPEED GEAR (29-44T.)

**Packaging Unit:** 1

**OEM No :**  
389 262 3713

**Model:**  
G240-16/11,72-0,69  
G260-16/9,75-0,57

**EX / CROSS :**  
945 262 3913  
389 262 3013



T44042



**Description:**  
4TH SPEED GEAR (35-51T.)

**Packaging Unit:** 1

**OEM No :**  
976 262 0814

**Model:**  
G100-12  
GO170-6/8,2-1,0  
GO190-6/8,2-1,0  
GO230-6/6,5-0,8  
GO4/160-6/8,2

**EX / CROSS :**  
976 262 0214  
389 262 1114  
389 262 0914  
389 262 0814

T45604



**Description:**  
4TH SPEED GEAR (35-54T.)

**Packaging Unit:** 1

**OEM No :**  
970 262 1114

**Model:**  
G60-6/9,20-1,00  
G85-6/6,70-0,83  
GO110-6/6,1-0,747

**EX / CROSS :**  
975 262 0114  
695 262 0014  
970 262 1214

T61106



**Description:**  
4TH SPEED GEAR (35T.)

**Packaging Unit:** 1

**OEM No :**  
970 260 2344

**Model:**

**EX / CROSS :**  
970 260 0914

T15161



**Description:**  
4TH SPEED GEAR (36-36-36T.)

**Packaging Unit:** 1

**OEM No :**  
389 262 3810

**Model:**  
G240-16/11,72-0,69

**EX / CROSS :**

T15162



**Description:**  
4TH SPEED GEAR (36-44-36T.)

**Packaging Unit:** 1

**OEM No :**  
389 262 7910

**Model:**  
G240-16/11,72-0,69  
G260-16/9,75-0,57

**EX / CROSS :**  
945 262 2810





<p><b>T20992</b></p> 	<p><b>Description:</b> 4TH SPEED GEAR (36-44-36T.)</p> <p><b>OEM No :</b> 945 262 9517</p> <p><b>EX / CROSS :</b> 945 262 5617</p>	<p><b>Packaging Unit:</b> 1</p> <p><b>Model:</b></p>
<p><b>T12227</b></p> 	<p><b>Description:</b> 4TH SPEED GEAR (44-24-51T.)</p> <p><b>OEM No :</b> 389 262 5610</p> <p><b>EX / CROSS :</b> 389 262 4410</p>	<p><b>Packaging Unit:</b> 1</p> <p><b>Model:</b> G155-16/11,9 G155-16/14,0 G180-16/11,9 G180-16/14,0 G200-16/11,9</p>
<p><b>T15167</b></p> 	<p><b>Description:</b> 4TH SPEED GEAR (44-29-51T.)</p> <p><b>OEM No :</b> 945 262 8810</p> <p><b>EX / CROSS :</b> 945 262 0510 945 262 2610 945 262 2310 945 262 8910</p>	<p><b>Packaging Unit:</b> 1</p> <p><b>Model:</b></p>
<p><b>T16906</b></p> 	<p><b>Description:</b> 4TH SPEED GEAR (51-24-51T.)</p> <p><b>OEM No :</b> 389 262 5410</p> <p><b>EX / CROSS :</b> 389 262 1510</p>	<p><b>Packaging Unit:</b> 1</p> <p><b>Model:</b> G125-16/14,0 G135-16/11,9</p>
<p><b>T12222</b></p> 	<p><b>Description:</b> 4TH SPEED GEAR (51-24-51T.)</p> <p><b>OEM No :</b> 389 262 3710</p> <p><b>EX / CROSS :</b> 389 262 1710 389 262 1610</p>	<p><b>Packaging Unit:</b> 1</p> <p><b>Model:</b> G155-16/11,9 G155-16/14,0 G180-16/11,9 G180-16/14,0</p>



T13517



**Description:**

4TH SPEED GEAR (51-24-51T.)

**Packaging Unit:** 1

**OEM No :**

389 262 1110

**Model:**

G155-16/11,9  
G155-16/14,0  
G180-16/11,9  
G180-16/14,0

**EX / CROSS :**

389 262 0210

T12226



**Description:**

4TH SPEED GEAR (51-24-51T.)

**Packaging Unit:** 1

**OEM No :**

389 262 5510

**Model:**

G155-16/11,9  
G155-16/14,0  
G180-16/11,9  
G180-16/14,0

**EX / CROSS :**

389 262 2310

T15163



**Description:**

4TH SPEED GEAR (51-29-51T.)

**Packaging Unit:** 1

**OEM No :**

389 262 8610

**Model:**

G210-16/14,2-0,83

**EX / CROSS :**

T07569



**Description:**

4TH SPEED GEAR CNTRSHFT (27T.)

**Packaging Unit:** 1

**OEM No :**

337 263 0814

**Model:**

G3/60-5/6,1 Brazil

**EX / CROSS :**

337 263 0314

T08540



**Description:**

4TH SPEED GEAR CNTRSHFT (27T.)

**Packaging Unit:** 1

**OEM No :**

307 263 0614

**Model:**

G3/60-5/6,1  
G3/61-5/6,1  
G3/61-5/6,1 Brazil  
GO3/60-5/5,4  
GO3/60-5/5,4 Turkey

**EX / CROSS :**



T07565



**Description:**

4TH SPEED GEAR CNTRSHFT (29T.)

**Packaging Unit:** 1

**OEM No :**

322 263 0614

**Model:**

G3/36-5/8,98  
G3/40-5/7,5  
G3/40-5/7,5 Indonesian

**EX / CROSS :**

322 263 0514

322 263 0314

322 263 0114

T08316



**Description:**

4TH SPEED GEAR CNTRSHFT (33T.)

**Packaging Unit:** 1

**OEM No :**

314 263 1414

**Model:**

G2/24-5/6,71  
G2/24-5/6,71 Brazil  
G2/24-5/7,31  
G2/24-5/7,31 Brazil

**EX / CROSS :**

314 263 1214

314 263 0614

314 263 0514

T51119



**Description:**

5TH SPEED GEAR (28T.)

**Packaging Unit:** 2

**OEM No :**

976 262 1515

**Model:**

G100-12

**EX / CROSS :**

976 262 0015

976 262 0915

976 262 1615

T54378



**Description:**

5TH SPEED GEAR (28T.)

**Packaging Unit:** 1

**OEM No :**

694 262 0115

**Model:**

G60-6/9,20-1,00

**EX / CROSS :**

T61898



**Description:**

5TH SPEED GEAR (30T.)

**Packaging Unit:** 1

**OEM No :**

389 262 1615



**Model:**

GO170-6/8,2-1,0  
GO190-6/8,2-1,0

**EX / CROSS :**





<p><b>T65633</b></p> 	<p><b>Description:</b> 5TH SPEED GEAR (45T.)</p> <p><b>OEM No :</b> 976 263 0215</p> <p><b>EX / CROSS :</b> 976 263 0615</p>	<p><b>Packaging Unit:</b> 1</p> <p><b>Model:</b> G100-12</p>
<p><b>T54380</b></p> 	<p><b>Description:</b> 5TH SPEED GEAR CNTRSHFT (45T.)</p> <p><b>OEM No :</b> 970 263 0615</p> <p><b>EX / CROSS :</b> 970 263 0515 694 263 0015</p>	<p><b>Packaging Unit:</b> 1</p> <p><b>Model:</b> G60-6/9,20-1,00 G71-6</p>
<p><b>T61936</b></p> 	<p><b>Description:</b> 5TH SPEED GEAR CNTRSHFT (47T.)</p> <p><b>OEM No :</b> 389 263 0915</p> <p><b>EX / CROSS :</b> 389 263 0815 389 263 0415</p>	<p><b>Packaging Unit:</b> 1</p> <p><b>Model:</b> GO170-6/8,2-1,0 GO190-6/8,2-1,0</p>
<p><b>T94032</b></p> 	<p><b>Description:</b> 5TH SPEED GEAR W/CONE (28T.)</p> <p><b>OEM No :</b> 970 260 1944</p> <p><b>EX / CROSS :</b></p>	<p><b>Packaging Unit:</b> 1</p> <p><b>Model:</b> G60-6/9,20-1,00</p>
<p><b>T45627</b></p> 	<p><b>Description:</b> 6TH SPEED GEAR (24-24T.)</p> <p><b>OEM No :</b> 976 262 0816</p> <p><b>EX / CROSS :</b> 976 262 0916 976 262 0216 976 262 0516 976 262 0116</p>	<p><b>Packaging Unit:</b> 1</p> <p><b>Model:</b> G85-6/6,70-0,83</p>

**T63703**

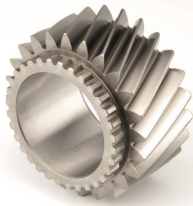

**Description:**  
6TH SPEED GEAR (24-32T.)

**Packaging Unit:** 1

**OEM No :**  
656 262 0016

**Model:**  
GO210-6/6,53-0,80

**EX / CROSS :**

**T40499**



**Description:**  
6TH SPEED GEAR (24T.)

**Packaging Unit:** 1

**OEM No :**  
976 262 1016

**Model:**  
G85-6/6,70-0,83

**EX / CROSS :**

**T69315**



**Description:**  
6TH SPEED GEAR (26-32T.)

**Packaging Unit:** 1

**OEM No :**  
656 262 0116

**Model:**  
GO210-6/6,53-0,80

**EX / CROSS :**

**T53139**



**Description:**  
6TH SPEED GEAR (26-35T.)

**Packaging Unit:** 1

**OEM No :**  
389 262 0716

**Model:**  
GO210-6/6,53-0,80  
GO230-6/6,5-0,8

**EX / CROSS :**  
389 262 0816  
389 262 0116  
389 262 0416

**T19667**



**Description:**  
6TH SPEED GEAR (44-23-44T.)

**Packaging Unit:** 1

**OEM No :**  
976 262 1510

**Model:**  
G100-12

**EX / CROSS :**



T22070



**Description:**  
6TH SPEED GEAR (55T.)

**Packaging Unit:** 1

**OEM No :**  
976 263 0710

**Model:**  
G100-12

**EX / CROSS :**

T56722



**Description:**  
6TH SPEED GEAR CNTRSHFT (51T.)

**Packaging Unit:** 1

**OEM No :**  
389 263 0116

**Model:**  
GO210-6/6,53-0,80  
GO230-6/6,5-0,8

**EX / CROSS :**

T63707



**Description:**  
6TH SPEED GEAR CNTRSHFT (52T.)

**Packaging Unit:** 1

**OEM No :**  
656 263 0016

**Model:**  
GO210-6/6,53-0,80

**EX / CROSS :**

T45649



**Description:**  
6TH SPEED GEAR CNTRSHFT (53T.)

**Packaging Unit:** 1

**OEM No :**  
976 263 0216

**Model:**  
G85-6/6,70-0,83

**EX / CROSS :**  
976 263 0016  
695 263 0016  
975 263 0116  
970 263 0016

T69742



**Description:**  
6TH SPEED GEAR REPAIR KIT

**Packaging Unit:** 1

**OEM No :**  
TAS69742

**Model:**  
G85-6/6,70-0,83

**EX / CROSS :**



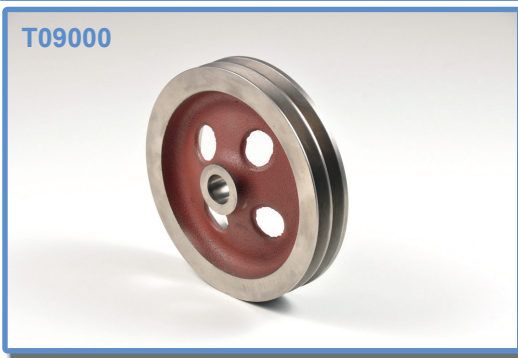

**Description:**  
AIR COMPRESSOR PULLEY

**Packaging Unit:** 1

**OEM No :**  
355 132 0215

**Model:**

**EX / CROSS :**



**Description:**  
BALL BEARING (17X35X10)

**Packaging Unit:** 1

**OEM No :**  
010 981 9025

**Model:**

**EX / CROSS :**

G131-9  
G141-9  
G181-9  
G210-16/14,2-0,83  
G211-12 Klauen  
G211-16/17,03-1,0  
G230-12 Klauen  
G230-16/14,2-0,83  
G231-16/17,03-1,0  
G241-16 Klauen  
G280-16 Klauen  
G281-12 Klauen

010 981 8425  
008 981 5425  
008 981 3425



**Description:**  
BALL BEARING (25X62X24)

**Packaging Unit:** 1

**OEM No :**  
004 981 2125

**Model:**

**EX / CROSS :**

002 981 8925



**Description:**  
BALL BEARING (55X100X21)

**Packaging Unit:** 1

**OEM No :**  
002 981 8125

**Model:**

**EX / CROSS :**

000625 036211

HD 4/02 DG-10  
HD 4/02 DG-10 BRAZIL  
HD 4/02 GD-10  
HD 4/021 GS-10 BRAZIL  
HD 4/21 DG-10  
HD 4/21 G-10  
HD 4/21 G-10 BRAZIL  
HD 4/22-10  
HD 7/11 DG-9  
HD 7/19 DG-13  
HD 7/19 DG-13 TURKEY  
HD 7/19 DGS-13  
HD 7/19 DGS-13 TURKEY  
HD 7/19 DGS-13

HD 7/19 DGS-13 TURKEY  
HD 7/19 DSG-13  
HD 7/2 DG-10  
HD 7/2 DLG-10  
HD 7/2 DSG-10  
HD 7/5 DG-10  
UG100-8/9,57-0,7 GPA  
UNIMOG  
UG3/40-8/13,01 UNIMOG  
UG3/65-8/13,01 UNIMOG



**Description:**  
BALL BEARING (55X120X29)

**Packaging Unit:** 1





**OEM No :**  
009 981 5525

**Model:**

**EX / CROSS :**

800574 A





007 981 0525





<p><b>T58413</b></p> 	<p><b>Description:</b> BALL BEARING (60X110X22)</p> <p><b>OEM No :</b> 005 981 5925</p> <p><b>EX / CROSS :</b> 005 981 6025 000625 036212</p>	<p><b>Packaging Unit:</b> 1</p> <p><b>Model:</b> HD 7/014 DG-16 HD 7/014 DGS-16 HD 7/014 DGS-16 TURKEY HD 7/016 DG-13 HD 7/016 DSG-13 HD 7/055 DCGS-13 HD 7/056 DGS-13 HD 7/056 DGS-16 HD 7/09 DG-10 HD 7/55 DCGS-13 HD 7/56 DGS-13</p>
<p><b>T58390</b></p> 	<p><b>Description:</b> BALL BEARING (70X125X24)</p> <p><b>OEM No :</b> 003 981 4925</p> <p><b>EX / CROSS :</b> 003 981 4525 000625 036214</p>	<p><b>Packaging Unit:</b> 1</p> <p><b>Model:</b> HD 7/11 DG-9 HD 7/19 DG-13 HD 7/19 DGS-13 HD 7/19 DSG-13 HD 7/2 DG-10 HD 7/2 DLG-10 HD 7/2 DSG-10 HD 7/5 DG-10</p>
<p><b>T65734</b></p> 	<p><b>Description:</b> BALL BEARING (72X130X25)</p> <p><b>OEM No :</b> 009 981 3325</p> <p><b>EX / CROSS :</b> 009 981 3625 009 981 3525 009 981 3425</p>	<p><b>Packaging Unit:</b> 1</p> <p><b>Model:</b> G211-12 Klauen G230-12 Klauen</p>
<p><b>T47545</b></p> 	<p><b>Description:</b> BALL BEARING (80X150X28)</p> <p><b>OEM No :</b> 008 981 3025</p> <p><b>EX / CROSS :</b> F-805045</p>	<p><b>Packaging Unit:</b> 1</p> <p><b>Model:</b> G100-12 G181-9 G210-16/14,2-0,83 G211-16/17,03-1,0 G221-9/10,19-1,00 G230-16/14,2-0,83 G231-16/17,03-1,0 G240-16/11,72-0,69 G241-16 Klauen G260-16/9,75-0,57 G280-16 Klauen G281-12 Klauen</p> <p>G330-12/11,64-0,78</p>
<p><b>T22628</b></p> 	<p><b>Description:</b> BALL BEARING (85X150X28)</p> <p><b>OEM No :</b> 004 981 9325</p> <p><b>EX / CROSS :</b> 004 981 8925 004 981 8525</p>	<p><b>Packaging Unit:</b> 1</p> <p><b>Model:</b> G125-16/14,0 G135-16/11,9 G155-16/11,9 G155-16/14,0 G155-9/15,9 G180-16/11,9 G180-16/14,0 G200-16/11,9 G210-16/14,2-0,83 G240-16/11,72-0,69 GO210-8/11,8</p>

<p><b>T47537</b></p> 	<p><b>Description:</b> BALL BEARING WITH BUSH (90X130X14)</p> <p><b>OEM No :</b> 008 981 1325</p> <p><b>EX / CROSS :</b> F-221001</p>	<p><b>Packaging Unit:</b> 1</p> <p><b>Model:</b> G125-16/14,0 G135-16/11,9 G155-16/11,9 G155-16/14,0 G155-9/15,9 G180-16/11,9 G180-16/14,0 G181-9 G200-16/11,9 G210-16/14,2-0,83 G211-12 Klauen G211-16/17,03-1,0 G221-9/10,19-1,00 G230-12 Klauen G230-16/14,2-0,83 G231-16/17,03-1,0 G240-16/11,72-0,69 G241-16 Klauen G260-16/9,75-0,57 G280-16 Klauen G281-12 Klauen G330-12/11,64-0,78 GO210-8/11,8</p>
<p><b>T68315</b></p> 	<p><b>Description:</b> BALL JOINT</p> <p><b>OEM No :</b> 000 996 9345</p> <p><b>EX / CROSS :</b> 000 996 6645</p>	<p><b>Packaging Unit:</b> 1</p> <p><b>Model:</b> Gearbox Articulation Section</p>
<p><b>T68311</b></p> 	<p><b>Description:</b> BALL JOINT</p> <p><b>OEM No :</b> 000 996 9445</p> <p><b>EX / CROSS :</b> 000 996 6745</p>	<p><b>Packaging Unit:</b> 1</p> <p><b>Model:</b></p>
<p><b>T68320</b></p> 	<p><b>Description:</b> BALL JOINT</p> <p><b>OEM No :</b> 000 996 9645</p> <p><b>EX / CROSS :</b></p>	<p><b>Packaging Unit:</b></p> <p><b>Model:</b></p>
<p><b>T65699</b></p> 	<p><b>Description:</b> BEARING</p> <p><b>OEM No :</b> 009 981 0510</p> <p><b>EX / CROSS :</b></p>	<p><b>Packaging Unit:</b> 1</p> <p><b>Model:</b> MPS KIT</p>









<p><b>T65714</b></p> 	<p><b>Description:</b> BEARING (40X90X25,25)</p> <p><b>OEM No :</b> 001 981 3105</p> <p><b>EX / CROSS :</b> 006 981 5305 001 981 5005 006 981 4305</p>	<p><b>Packaging Unit:</b> 1</p> <p><b>Model:</b> G3/36-5/8,98 G3/40-5/7,5 G3/40-5/7,5 Indonesian G3/45-6/8,5 G3/50-5/8,5 G3/55-6/8,5 G3/60-5/6,1 G3/60-5/6,1 Brazil G3/60-5/7,5 G3/61-5/6,1 G3/61-5/6,1 Brazil G3/65-8/9,29 G3/65-9/13,36 G3/70-4/4,24 G3/90-8/9,29 G4/65-6/9,0 G4/65-7/11,0 G03/60-5/5,4 Turkey G03/80-4/4,43</p>
<p><b>T65697</b></p> 	<p><b>Description:</b> BEARING (65X120X23)</p> <p><b>OEM No :</b> 009 981 0325</p> <p><b>EX / CROSS :</b> 6213/C3</p>	<p><b>Packaging Unit:</b> 1</p> <p><b>Model:</b> G131-9 G141-9</p>
<p><b>T65728</b></p> 	<p><b>Description:</b> BEARING (65X140X33)</p> <p><b>OEM No :</b> 008 981 5201</p> <p><b>EX / CROSS :</b> 007 981 5701 006 981 2801 004 981 3301 004 981 3101</p>	<p><b>Packaging Unit:</b> 1</p> <p><b>Model:</b> G4/110-6/9,0 G4/95-6/9,0 G4/95-7/11,0 G04/105-6/7,18 G04/110-5/5,1 G04/120-6/7,18 G04/130-6/7,18 G04/160-6/7,18 G04/95-5/5,1 GV4/110-6/9,0 GV4/95-6/9,0</p>
<p><b>T65695</b></p> 	<p><b>Description:</b> BEARING (77X110X20)</p> <p><b>OEM No :</b> 008 981 9525</p> <p><b>EX / CROSS :</b></p>	<p><b>Packaging Unit:</b> 1</p> <p><b>Model:</b> G131-9 G141-9</p>
<p><b>T16979</b></p> 	<p><b>Description:</b> BUSH</p> <p><b>OEM No :</b> 337 283 5150</p> <p><b>EX / CROSS :</b></p>	<p><b>Packaging Unit:</b> 4</p> <p><b>Model:</b> W600-3W</p>





<p><b>T15517</b></p> 	<p><b>Description:</b> BUSH</p> <p><b>OEM No :</b> 387 267 0650</p> <p><b>EX / CROSS :</b> 387 267 0250</p>	<p><b>Packaging Unit:</b> 1</p> <p><b>Model:</b> G100-12 G125-16/14,0 G135-16/11,9 G140-8 G141-9 G155-16/11,9 G155-16/14,0 G155-9/15,9 G180-16/11,9 G180-16/14,0 G200-16/11,9 G210-16/14,2-0,83 G211-12 Klauen G211-16/17,03-1,0 G221-9/10,19-1,00 G230-12 Klauen G230-16/14,2-0,83 G231-16/17,03-1,0 G240-16/11,72-0,69 G241-16 Klauen G260-16/9,75-0,57 G280-16 Klauen G281-12 Klauen G330-12/11,64-0,78</p>
<p><b>T08990</b></p> 	<p><b>Description:</b> BUSH</p> <p><b>OEM No :</b> 346 353 0950</p> <p><b>EX / CROSS :</b></p>	<p><b>Packaging Unit:</b> 4</p> <p><b>Model:</b> HD 7/014 DG-16 HD 7/014 DGS-16 HD 7/014 DGS-16 TURKEY HD 7/016 DG-13 HD 7/016 DSG-13 HD 7/09 DG-10 HL 7/013 D-16 HL 7/013 DS-16 TURKEY HL 7/015 D-13 HL 7/015 D-13 TURKEY HL 7/015 DL-13 HL 7/015 DS-13 HL 7/02 DL-10 HL 7/021 D-10 HL 7/021 DL-10 HL 7/021 DS-10 HL 7/024 D-12,3 HL 7/024 DL-12,3 HL 7/050 DCS-11,5 HL 7/052 DCS-13 HL 7/052 DS-13 HL 7/07 D-10 HL 7/07 D-11,5 HL 7/07 DL-10</p>
<p><b>T17269</b></p> 	<p><b>Description:</b> BUSH</p> <p><b>OEM No :</b> 389 263 0850</p> <p><b>EX / CROSS :</b></p>	<p><b>Packaging Unit:</b> 1</p> <p><b>Model:</b> G155-16/11,9 G155-16/14,0 G155-9/15,9 G180-16/11,9 G180-16/14,0 G181-9 G200-16/11,9 G210-16/14,2-0,83 G211-16/17,03-1,0 G221-9/10,19-1,00 G230-16/14,2-0,83 G231-16/17,03-1,0 G240-16/11,72-0,69 G241-16 Klauen G260-16/9,75-0,57 G280-16 Klauen G281-12 Klauen G330-12/11,64-0,78 GO210-8/11,8</p>
<p><b>T18705</b></p> 	<p><b>Description:</b> BUSH</p> <p><b>OEM No :</b> 000 353 1550</p> <p><b>EX / CROSS :</b> 000 353 1450</p>	<p><b>Packaging Unit:</b> 1</p> <p><b>Model:</b></p>
<p><b>T61840</b></p> 	<p><b>Description:</b> BUSH</p> <p><b>OEM No :</b> 389 262 0150</p> <p><b>EX / CROSS :</b></p>	<p><b>Packaging Unit:</b> 1</p> <p><b>Model:</b> G125-16/14,0 G135-16/11,9 G230-16/14,2-0,83 G240-16/11,72-0,69 G241-16 Klauen G260-16/9,75-0,57 G280-16 Klauen</p>



<p><b>T61090</b></p> 	<p><b>Description:</b> BUSH</p> <p><b>OEM No :</b> TAS61090</p> <p><b>EX / CROSS :</b></p>	<p><b>Packaging Unit:</b> 4</p> <p><b>Model:</b>            HD 4/02 DG-10            HD 4/02 DG-10 BRAZIL            HD 4/02 GD-10            HD 4/021 GS-10 BRAZIL            HD 4/21 DG-10            HD 4/21 G-10            HD 4/21 G-10 BRAZIL            HD 4/22-10            HD 7/11 DG-9            HD 7/19 DG-13            HD 7/19 DG-13 TURKEY            HD 7/19 DGS-13            HD 7/19 DGS-13 TURKEY            HD 7/19 DSG-13            HD 7/19 DSG-13 TURKEY            HD 7/2 DG-10            HD 7/2 DLG-10            HD 7/2 DSG-10            HD 7/5 DG-10            HD 7/19 DGS-13 TURKEY            HD 7/19 DSG-13</p>
<p><b>T15303</b></p> 	<p><b>Description:</b> BUSH</p> <p><b>OEM No :</b> 659 353 0050</p> <p><b>EX / CROSS :</b></p>	<p><b>Packaging Unit:</b> 4</p> <p><b>Model:</b>            HD 7/014 DG-16            HD 7/014 DGS-16            HD 7/014 DGS-16 TURKEY            HD 7/016 DG-13            HD 7/016 DSG-13            HD 7/09 DG-10</p>
<p><b>T17369</b></p> 	<p><b>Description:</b> BUSH</p> <p><b>OEM No :</b> 389 262 2550</p> <p><b>EX / CROSS :</b> 389 262 1650 389 262 0050</p>	<p><b>Packaging Unit:</b> 1</p> <p><b>Model:</b></p>
<p><b>T93577</b></p> 	<p><b>Description:</b> BUSH</p> <p><b>OEM No :</b> 002 992 1501</p> <p><b>EX / CROSS :</b></p>	<p><b>Packaging Unit:</b> 1</p> <p><b>Model:</b></p>
<p><b>T09024</b></p> 	<p><b>Description:</b> BUSH (22,1X26X24,5)</p> <p><b>OEM No :</b> 355 353 0750</p> <p><b>EX / CROSS :</b></p>	<p><b>Packaging Unit:</b> 4</p> <p><b>Model:</b>            AL 7/1 D-7            AL 7/5 D-7            HD 7/11 DG-9            HD 7/19 DG-13            HD 7/19 DGS-13            HD 7/19 DSG-13            HD 7/2 DG-10            HD 7/2 DLG-10            HD 7/2 DSG-10            HD 7/5 DG-10            HL 7/1 D-10            HL 7/1 DL-10            HL 7/1 L-10            HL 7/1 S-10            HL 7/10 D-9            HL 7/18 D-13            HL 7/18 DS-13            HL 7/24 DS-9            HL 7/3 D-10            HL 7/3 DL-10            HL 7/3 DS-10            HL 7/4 D-10            HO 7/8 DL-10</p>









<p><b>T14193</b></p> 	<p><b>Description:</b> BUSH (27X31X24)</p> <p><b>OEM No :</b> 653 353 0050</p> <p><b>EX / CROSS :</b></p>	<p><b>Packaging Unit:</b> 4</p> <p><b>Model:</b> HD 4/02 DG-10 HD 4/02 GD-10 HD 4/021 GS-10 BRAZIL HD 4/21 DG-10 HD 4/21 G-10 HD 4/21 G-10 BRAZIL HD 4/22-10 HD 7/11 DG-9 HD 7/19 DG-13 HD 7/19 DGS-13 HD 7/19 DSG-13 HD 7/2 DG-10</p> <p>HD 7/2 DLG-10 HD 7/2 DSG-10 HD 7/5 DG-10</p>
<p><b>T45623</b></p> 	<p><b>Description:</b> BUSH (47,5X37X26)</p> <p><b>OEM No :</b> 970 981 0081</p> <p><b>EX / CROSS :</b></p>	<p><b>Packaging Unit:</b> 1</p> <p><b>Model:</b> G60-6/9,20-1,00 G71-6 G85-6/6,70-0,83 G90-6 GO110-6/6,1-0,747</p>
<p><b>T11446</b></p> 	<p><b>Description:</b> BUSH (49X44X35)</p> <p><b>OEM No :</b> 355 353 1050</p> <p><b>EX / CROSS :</b> 355 353 0150</p>	<p><b>Packaging Unit:</b> 1</p> <p><b>Model:</b> HD 4/02 DG-10 HD 4/02 DG-10 BRAZIL HD 4/02 GD-10 HD 4/021 GS-10 BRAZIL HD 4/21 DG-10 HD 4/21 G-10 HD 4/21 G-10 BRAZIL HD 4/22-10 HD 7/11 DG-9 HD 7/19 DG-13 HD 7/19 DG-13 TURKEY HD 7/19 DGS-13</p> <p>HD 7/19 DGS-13 TURKEY HD 7/2 DG-10 HD 7/2 DLG-10 HD 7/2 DSG-10 HD 7/5 DG-10</p>
<p><b>T14770</b></p> 	<p><b>Description:</b> BUSH (50X57X41)</p> <p><b>OEM No :</b> 346 353 0650</p> <p><b>EX / CROSS :</b> 346 353 1050</p>	<p><b>Packaging Unit:</b> 1</p> <p><b>Model:</b> HD 7/014 DG-16 HD 7/014 DGS-16 HD 7/014 DGS-16 TURKEY HD 7/016 DG-13 HD 7/016 DSG-13 HD 7/055 DCGS-13 HD 7/056 DGS-13 HD 7/056 DGS-16 HD 7/09 DG-10 HD 7/55 DCGS-13 HD 7/56 DGS-13</p>
<p><b>T09017</b></p> 	<p><b>Description:</b> BUSH (64X60X50)</p> <p><b>OEM No :</b> 355 353 0950</p> <p><b>EX / CROSS :</b> 355 353 0250</p>	<p><b>Packaging Unit:</b> 1</p> <p><b>Model:</b></p>



<p><b>T14768</b></p> 	<p><b>Description:</b> BUSH (75X70X53,5)</p> <p><b>OEM No :</b> 346 353 0450</p> <p><b>EX / CROSS :</b></p> <p><b>Packaging Unit:</b> 1</p> <p><b>Model:</b> HD 7/014 DG-16 HD 7/014 DGS-16 HD 7/014 DGS-16 TURKEY HD 7/016 DG-13 HD 7/016 DSG-13 HD 7/09 DG-10</p>
<p><b>T74803</b></p> 	<p><b>Description:</b> BUSH (80X70,15X30)</p> <p><b>OEM No :</b> TAS74803</p> <p><b>EX / CROSS :</b></p> <p><b>Packaging Unit:</b> 1</p> <p><b>Model:</b> HL 6/1 DC(L,S)-13 (REINFORCED) HL 6/1 DC(LC)-13 (OLD VERSION) HL 6/1 DC(LC)-13 (REINFORCED) HL 6/3 DC(L,S)-13 (OLD VERSION)</p>
<p><b>T08194</b></p> 	<p><b>Description:</b> BUSH (T.44,20)</p> <p><b>OEM No :</b> 322 262 5650</p> <p><b>EX / CROSS :</b> 322 262 1150</p> <p><b>Packaging Unit:</b> 1</p> <p><b>Model:</b> G3/40-5/7,5 Indonesian</p>
<p><b>T08196</b></p> 	<p><b>Description:</b> BUSH (T.44,50)</p> <p><b>OEM No :</b> 322 262 6550</p> <p><b>EX / CROSS :</b> 322 262 4050</p> <p><b>Packaging Unit:</b> 1</p> <p><b>Model:</b> G3/36-5/8,98 G3/40-5/7,5 G3/40-5/7,5 Indonesian</p>
<p><b>T44595</b></p> 	<p><b>Description:</b> CAM MOULDED</p> <p><b>OEM No :</b> 387 260 2873</p> <p><b>EX / CROSS :</b></p> <p><b>Packaging Unit:</b> 1</p> <p><b>Model:</b> MPS KIT</p>



<p><b>T84213</b></p> 	<p><b>Description:</b> CAM MOULDED</p> <p><b>OEM No :</b> 945 268 0746/1</p> <p><b>EX / CROSS :</b></p>	<p><b>Packaging Unit:</b> 1</p> <p><b>Model:</b></p>
<p><b>T84214</b></p> 	<p><b>Description:</b> CAM MOULDED</p> <p><b>OEM No :</b> 945 268 0746</p> <p><b>EX / CROSS :</b> 945 260 0073</p>	<p><b>Packaging Unit:</b> 1</p> <p><b>Model:</b></p>
<p><b>T73716</b></p> 	<p><b>Description:</b> CLUTCH CYLINDER</p> <p><b>OEM No :</b> 002 295 0706</p> <p><b>EX / CROSS :</b></p>	<p><b>Packaging Unit:</b> 1</p> <p><b>Model:</b> Clutch Cylinder</p>
<p><b>T81510</b></p> 	<p><b>Description:</b> CLUTCH FORK KIT WITH 2 ROLLERS PINS</p> <p><b>OEM No :</b> TAS81510</p> <p><b>EX / CROSS :</b></p>	<p><b>Packaging Unit:</b> 1</p> <p><b>Model:</b></p>
<p><b>T73032</b></p> 	<p><b>Description:</b> CLUTCH FORK SHAFT KIT</p> <p><b>OEM No :</b> 655 254 0206</p> <p><b>EX / CROSS :</b></p>	<p><b>Packaging Unit:</b> 1</p> <p><b>Model:</b> G131-9 G210-16/14,2-0,83 G211-12 Klauen G211-16/17,03-1,0 G221-9/10,19-1,00 G230-12 Klauen G230-16/14,2-0,83 G231-16/17,03-1,0 G240-16/11,72-0,69 G241-16 Klauen G260-16/9,75-0,57 G280-16 Klauen G281-12 Klauen G330-12/11,64-0,78</p>



**T94237**



**Description:**

CLUTCH FORK SHAFT KIT 655 254 0206 WITH 2 ROLLERS PINS

**Packaging Unit:** 1

**OEM No :**

TAS94237

**Model:**

**EX / CROSS :**

**T67824**



**Description:**

CLUTCH KIT

**Packaging Unit:**

**OEM No :**

TAS67824

**Model:**

G210-16/14,2-0,83  
G210-16/14,2-0,83 ESP  
G211-16/17,03-1,0  
G230-16/14,2-0,83  
G231-16/17,03-1,0  
G240-16/11,72-0,69  
G240-16/11,72-0,69 ESP  
G260-16/9,75-0,57

**EX / CROSS :**

**T58296**



**Description:**

CONSTANT GEAR

**Packaging Unit:** 1

**OEM No :**

930 262 2217

**Model:**

G241-16 Klauen

**EX / CROSS :**

945 262 3017

945 262 3117

945 262 3617

**T65930**



**Description:**

CONSTANT GEAR

**Packaging Unit:** 1

**OEM No :**

930 262 0717

**Model:**

G281-12 Klauen

**EX / CROSS :**

960 262 0617

960 262 0517

948 262 2210

948 262 2310

**T65933**



**Description:**

CONSTANT GEAR

**Packaging Unit:** 1





**OEM No :**

947 262 3510

**Model:**

G230-12 Klauen

**EX / CROSS :**

<p><b>T18902</b></p> 	<p><b>Description:</b> CONSTANT GEAR (22-51T.)</p> <p><b>OEM No :</b> 389 262 1210</p> <p><b>EX / CROSS :</b></p> <p><b>Model:</b> G125-16/14,0</p>	<p><b>Packaging Unit:</b> 1</p>
<p><b>T12308</b></p> 	<p><b>Description:</b> CONSTANT GEAR (22-52T.)</p> <p><b>OEM No :</b> 389 262 2210</p> <p><b>EX / CROSS :</b></p> <p><b>Model:</b> G155-16/14,0 G180-16/14,0</p>	<p><b>Packaging Unit:</b> 1</p>
<p><b>T15160</b></p> 	<p><b>Description:</b> CONSTANT GEAR (22-60T.)</p> <p><b>OEM No :</b> 389 262 2810</p> <p><b>EX / CROSS :</b></p> <p><b>Model:</b> G155-16/14,0 G180-16/14,0</p>	<p><b>Packaging Unit:</b> 1</p>
<p><b>T20909</b></p> 	<p><b>Description:</b> CONSTANT GEAR (26-38T.)</p> <p><b>OEM No :</b> 976 262 0210</p> <p><b>EX / CROSS :</b> 976 262 2210</p> <p><b>Model:</b> G100-12</p>	<p><b>Packaging Unit:</b> 1</p>
<p><b>T12231</b></p> 	<p><b>Description:</b> CONSTANT GEAR (26-48T.)</p> <p><b>OEM No :</b> 389 262 7710</p> <p><b>EX / CROSS :</b> 389 262 2710</p> <p><b>Model:</b> G155-16/11,9 G180-16/11,9 G200-16/11,9</p>	<p><b>Packaging Unit:</b> 1</p>



T15544



**Description:**  
CONSTANT GEAR (26-60T.)

**Packaging Unit:** 1

**OEM No :**  
389 262 2910

**Model:**  
G155-16/11,9  
G180-16/11,9

**EX / CROSS :**

T65948



**Description:**  
CONSTANT GEAR (27T.)

**Packaging Unit:** 1

**OEM No :**  
930 262 3117

**Model:**  
G241-16 Klauen

**EX / CROSS :**  
930 262 0217  
930 262 0117

T39679



**Description:**  
CONSTANT GEAR (27T.)

**Packaging Unit:** 1

**OEM No :**  
945 262 4410

**Model:**  
G211-16/17,03-1,0  
G231-16/17,03-1,0

**EX / CROSS :**

T65951



**Description:**  
CONSTANT GEAR (29T.)

**Packaging Unit:** 1

**OEM No :**  
947 262 5210

**Model:**  
G211-12 Klauen

**EX / CROSS :**  
947 262 0210  
947 262 0310  
947 262 2110  
947 262 2210

T38829



**Description:**  
CONSTANT GEAR (31-58-30T.)

**Packaging Unit:** 1

**OEM No :**  
930 262 3617

**Model:**  
G281-12 Klauen  
G330-12/11,64-0,78

**EX / CROSS :**  
948 262 1210





T15168



**Description:**  
CONSTANT GEAR (32-36T.)

**Packaging Unit:** 1

**OEM No :**  
945 262 4110

**Model:**

**EX / CROSS :**  
945 262 1610  
945 262 3810  
945 262 3910

T20993



**Description:**  
CONSTANT GEAR (32-36T.)

**Packaging Unit:** 1

**OEM No :**  
945 262 9817

**Model:**

**EX / CROSS :**  
945 262 7517  
945 262 5417  
945 262 7617

T65956



**Description:**  
CONSTANT GEAR (32T.)

**Packaging Unit:** 1

**OEM No :**  
930 262 3217

**Model:**  
G280-16 Klauen

**EX / CROSS :**  
930 262 0517  
930 262 0417

T65960



**Description:**  
CONSTANT GEAR (34T.)

**Packaging Unit:** 1

**OEM No :**  
947 262 0117

**Model:**  
G211-12 Klauen  
G230-12 Klauen

**EX / CROSS :**  
947 262 1510

T65963



**Description:**  
CONSTANT GEAR (36T.)

**Packaging Unit:** 1

**OEM No :**  
930 262 2417

**Model:**  
G280-16 Klauen

**EX / CROSS :**  
930 262 1517  
945 262 4717  
945 262 4817

<p><b>T94330</b></p> 	<p><b>Description:</b> CONSTANT GEAR (37T.)</p> <p><b>OEM No :</b> 656 262 1010</p> <p><b>EX / CROSS :</b></p>	<p><b>Packaging Unit:</b> 1</p> <p><b>Model:</b> GO240-8/6,57-0,63 GO250-8/6,57-0,63</p>
<p><b>T38571</b></p> 	<p><b>Description:</b> CONSTANT GEAR (39T.)</p> <p><b>OEM No :</b> 945 262 5917</p> <p><b>EX / CROSS :</b></p>	<p><b>Packaging Unit:</b> 1</p> <p><b>Model:</b> G260-16/9,75-0,57</p>
<p><b>T38569</b></p> 	<p><b>Description:</b> CONSTANT GEAR (39T.)</p> <p><b>OEM No :</b> 945 262 4710</p> <p><b>EX / CROSS :</b> 945 262 4810 945 262 2510 945 262 0210 389 262 3910</p>	<p><b>Packaging Unit:</b> 1</p> <p><b>Model:</b> G210-16/14,2-0,83 G211-16/17,03-1,0 G231-16/17,03-1,0 G260-16/9,75-0,57</p>
<p><b>T38828</b></p> 	<p><b>Description:</b> CONSTANT GEAR (40-44T.)</p> <p><b>OEM No :</b> 930 262 1717</p> <p><b>EX / CROSS :</b> 948 262 1010</p>	<p><b>Packaging Unit:</b> 1</p> <p><b>Model:</b> G330-12/11,64-0,78</p>
<p><b>T17602</b></p> 	<p><b>Description:</b> CONSTANT GEAR CNTRSHFT (23T.)</p> <p><b>OEM No :</b> 389 263 0410</p> <p><b>EX / CROSS :</b></p>	<p><b>Packaging Unit:</b> 1</p> <p><b>Model:</b> G155-16/11,9 G180-16/11,9</p>

**T12234**



**Description:**

CONSTANT GEAR CNTRSHFT (23T.)

**Packaging Unit:** 1

**OEM No :**

389 263 1110

**Model:**

G155-16/11,9  
G180-16/11,9  
G200-16/11,9

**EX / CROSS :**

**T16908**



**Description:**

CONSTANT GEAR CNTRSHFT (23T.)

**Packaging Unit:** 1

**OEM No :**

389 263 0610

**Model:**

G135-16/11,9

**EX / CROSS :**

**T18850**



**Description:**

CONSTANT GEAR CNTRSHFT (27T.)

**Packaging Unit:** 1

**OEM No :**

389 263 1210

**Model:**

G155-16/14,0  
G180-16/14,0

**EX / CROSS :**

**T18903**



**Description:**

CONSTANT GEAR CNTRSHFT (27T.)

**Packaging Unit:** 1

**OEM No :**

389 263 0910

**Model:**

G155-16/14,0  
G180-16/14,0

**EX / CROSS :**

389 263 0310

**T15553**



**Description:**

CONSTANT GEAR CNTRSHFT (31T.)

**Packaging Unit:** 1

**OEM No :**

945 263 0810

**Model:**

G210-16/14,2-0,83  
G230-16/14,2-0,83  
G240-16/11,72-0,69

**EX / CROSS :**

945 263 0710

389 263 1410



**T08337**



**Description:**

CONSTANT GEAR CNTRSHFT (31T.)

**Packaging Unit:** 1

**OEM No :**  
337 263 0810

**Model:**  
G3/60-5/6,1 Brazil

**EX / CROSS :**  
337 263 0610

**T08284**



**Description:**

CONSTANT GEAR CNTRSHFT (31T.)

**Packaging Unit:** 1

**OEM No :**  
307 263 0110

**Model:**  
G3/60-5/6,1  
G3/61-5/6,1  
G3/61-5/6,1 Brazil

**EX / CROSS :**

**T65989**



**Description:**

CONSTANT GEAR CNTRSHFT (31T.)

**Packaging Unit:** 1

**OEM No :**  
930 263 2610

**Model:**  
G241-16 Klauen  
G280-16 Klauen

**EX / CROSS :**  
930 263 0510  
930 263 0410

**T41447**



**Description:**

CONSTANT GEAR CNTRSHFT (34T.) WITH SENSOR

**Packaging Unit:** 1

**OEM No :**  
960 260 0408

**Model:**  
G280-16 Klauen

**EX / CROSS :**

**T07574**



**Description:**

CONSTANT GEAR CNTRSHFT (36T.)

**Packaging Unit:** 1

**OEM No :**  
340 263 0110

**Model:**  
G3/40-5/7,5 Indonesian

**EX / CROSS :**  
340 263 0010



T08205



**Description:**

CONSTANT GEAR CNTRSHFT (38T.)

**Packaging Unit:** 1

**OEM No :**

322 263 0610

**Model:**

G3/36-5/8,98  
G3/40-5/7,5

**EX / CROSS :**

322 263 0010

T38534



**Description:**

CONSTANT GEAR CNTRSHFT (38T.)

**Packaging Unit:** 1

**OEM No :**

945 263 1110

**Model:**

G211-16/17,03-1,0  
G231-16/17,03-1,0

**EX / CROSS :**

945 263 0210

T08310



**Description:**

CONSTANT GEAR CNTRSHFT (38T.)

**Packaging Unit:** 1

**OEM No :**

314 263 0710

**Model:**

G2/24-5/6,71  
G2/24-5/6,71 Brazil  
G2/24-5/7,31

**EX / CROSS :**

314 263 0610

314 263 0210

T08537



**Description:**

CONSTANT GEAR CNTRSHFT (38T.)

**Packaging Unit:** 1

**OEM No :**

302 263 0410

**Model:**

G3/50-5/8,5  
G3/50-5/8,5 Brazil

**EX / CROSS :**

T66000



**Description:**

CONSTANT GEAR CNTRSHFT (38T.)

**Packaging Unit:** 1

**OEM No :**

930 263 2510

**Model:**

G241-16 Klauen

**EX / CROSS :**

930 263 0210

930 263 0110

<p><b>T94358</b></p> 	<p><b>Description:</b> CONSTANT GEAR CNTRSHFT (40T.)</p> <p><b>Packaging Unit:</b> 1</p> <p><b>OEM No :</b> 656 263 0810</p> <p><b>Model:</b> GO240-8/6,57-0,63 GO250-8/6,57-0,63</p> <p><b>EX / CROSS :</b> 656 263 0610</p>
<p><b>T45654</b></p> 	<p><b>Description:</b> CONSTANT GEAR CNTRSHFT (45T.)</p> <p><b>Packaging Unit:</b> 1</p> <p><b>OEM No :</b> 976 263 1110</p> <p><b>Model:</b> G85-6/6,70-0,83</p> <p><b>EX / CROSS :</b> 976 263 1210 695 263 0010 975 263 0110 693 263 0010</p>
<p><b>T53143</b></p> 	<p><b>Description:</b> CONSTANT GEAR CNTRSHFT (47T.)</p> <p><b>Packaging Unit:</b> 1</p> <p><b>OEM No :</b> 389 263 1910</p> <p><b>Model:</b> GO210-6/6,53-0,80 GO230-6/6,5-0,8</p> <p><b>EX / CROSS :</b> 389 263 2710</p>
<p><b>T19673</b></p> 	<p><b>Description:</b> CONSTANT GEAR CNTRSHFT (51T.)</p> <p><b>Packaging Unit:</b> 1</p> <p><b>OEM No :</b> 976 263 0810</p> <p><b>Model:</b></p> <p><b>EX / CROSS :</b></p>
<p><b>T54702</b></p> 	<p><b>Description:</b> CONSTANT GEAR CNTRSHFT (51T.)</p> <p><b>Packaging Unit:</b> 1</p> <p><b>OEM No :</b> 389 263 2910</p> <p><b>Model:</b> GO170-6/8,2-1,0 GO190-6/8,2-1,0</p> <p><b>EX / CROSS :</b> 389 263 2510 389 263 2110</p>





T51908



**Description:**

CONSTANT GEAR CNTRSHFT (53T.)

**Packaging Unit:** 1

**OEM No :**

970 263 0610

**Model:**

G60-6/9,20-1,00

**EX / CROSS :**

970 263 0510

970 263 0410

694 263 0010

T66073



**Description:**

COUNTERSHAFT

**Packaging Unit:** 1

**OEM No :**

947 263 2402

**Model:**

G211-12 Klauen  
G230-12 Klauen

**EX / CROSS :**

T94584

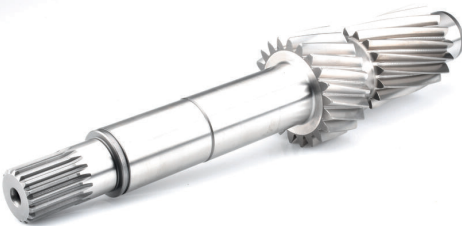

**Description:**

COUNTERSHAFT

**Packaging Unit:** 1

**OEM No :**

960 263 0002

**Model:**

G280-16 Klauen

**EX / CROSS :**

T08333



**Description:**

COUNTERSHAFT (11-17T.)

**Packaging Unit:** 1

**OEM No :**

337 263 0702

**Model:**

G3/60-5/6,1 Brazil

**EX / CROSS :**

337 263 0602

T08198



**Description:**

COUNTERSHAFT (11-17T.)

**Packaging Unit:** 1

**OEM No :**

322 263 0302

**Model:**

G3/36-5/8,98  
G3/40-5/7,5  
G3/40-5/7,5 Indonesian

**EX / CROSS :**

322 263 0202

321 263 0502

**T08347**



**Description:**  
COUNTERSHAFT (11-17T.)

**Packaging Unit:** 1

**OEM No :**  
383 263 0202

**Model:**  
G3/50-5/8,5  
G3/50-5/8,5 Brazil  
G3/60-5/6,1  
G3/60-5/7,5  
G3/60-5/7,5 Brazil  
G3/61-5/6,1  
G3/61-5/6,1 Brazil  
GO3/60-5/5,4  
GO3/60-5/5,4 Turkey

**EX / CROSS :**

**T17270**



**Description:**  
COUNTERSHAFT (12-17-21T.)

**Packaging Unit:** 1

**OEM No :**  
389 263 0902

**Model:**  
G155-9/15,9  
GO210-8/11,8

**EX / CROSS :**

**T53124**



**Description:**  
COUNTERSHAFT (12-19T.)

**Packaging Unit:** 1

**OEM No :**  
389 263 3402

**Model:**

**EX / CROSS :**  
389 263 2702  
389 263 2402

**T08313**



**Description:**  
COUNTERSHAFT (13-14-19-25T.)

**Packaging Unit:** 1

**OEM No :**  
314 263 1002

**Model:**  
G2/24-5/6,71  
G2/24-5/7,31

**EX / CROSS :**

**T15549**



**Description:**  
COUNTERSHAFT (14-17T.)

**Packaging Unit:** 1

**OEM No :**  
389 263 0802

**Model:**  
G155-16/11,9  
G155-16/14,0  
G180-16/11,9  
G180-16/14,0  
G200-16/11,9

**EX / CROSS :**

**T66111**



**Description:**  
COUNTERSHAFT (14T.)

**Packaging Unit:** 1

**OEM No :**  
947 263 0702

**Model:**  
G131-9  
G141-9

**EX / CROSS :**

**T70814**



**Description:**  
COUNTERSHAFT (16-15-15-18T.)

**Packaging Unit:** 1

**OEM No :**  
930 263 0402

**Model:**  
G281-12 Klauen  
G330-12/11,64-0,78

**EX / CROSS :**

**T17380**



**Description:**  
COUNTERSHAFT (16-16-21T.)

**Packaging Unit:** 1

**OEM No :**  
945 263 2902

**Model:**

**EX / CROSS :**  
389 263 2502  
389 263 3102  
945 263 0902  
389 262 1302

**T66117**

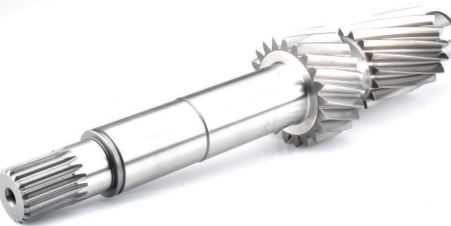

**Description:**  
COUNTERSHAFT (16-21T.)

**Packaging Unit:** 1

**OEM No :**  
930 263 0602

**Model:**  
G241-16 Klauen  
G280-16 Klauen

**EX / CROSS :**

**T66114**

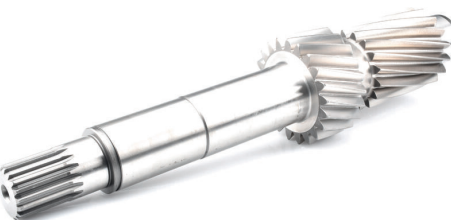

**Description:**  
COUNTERSHAFT (16-21T.)

**Packaging Unit:** 1

**OEM No :**  
930 263 0202

**Model:**  
G241-16 Klauen  
G280-16 Klauen

**EX / CROSS :**



**T45618**

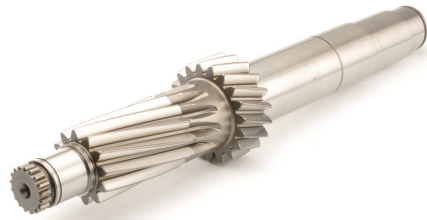

**Description:**  
COUNTERSHAFT (17-12-19T.)

**Packaging Unit:** 1

**OEM No :**  
970 263 0702

**Model:**  
G60-6/9,20-1,00  
G85-6/6,70-0,83  
GO110-6/6,1-0,747

**EX / CROSS :**  
975 263 0102  
694 263 0002  
970 263 0802

**T69151**



**Description:**  
COUNTERSHAFT (17-12-19T.)

**Packaging Unit:** 1

**OEM No :**  
970 263 0602

**Model:**  
G85-6/6,70-0,83

**EX / CROSS :**  
970 263 0402  
970 263 0302

**T55344**



**Description:**  
COUNTERSHAFT (25-20-12T.)

**Packaging Unit:** 1

**OEM No :**  
945 263 2202

**Model:**  
G181-9  
G221-9/10,19-1,00

**EX / CROSS :**  
945 263 2302  
945 263 0302  
  
945 263 0402

**T66843**

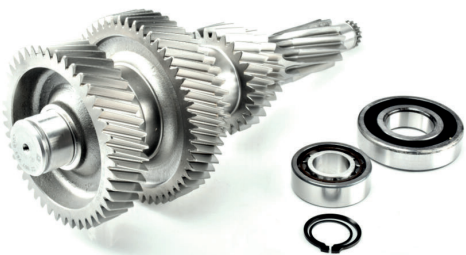

**Description:**  
COUNTERSHAFT ASSY

**Packaging Unit:** 1

**OEM No :**  
967 260 0124

**Model:**  
G90-6

**EX / CROSS :**

**T66141**



**Description:**  
COUNTERSHAFT KIT (16-21-31-29-34T.)

**Packaging Unit:** 1

**OEM No :**  
930 260 2124

**Model:**  
G241-16 Klauen  
G280-16 Klauen

**EX / CROSS :**

**T39792**



**Description:**

COUNTERSHAFT KIT (30-30-23-15-15T.)

**Packaging Unit:** 1

**OEM No :**

930 260 0124

**Model:**

**EX / CROSS :**

930 260 1824

930 260 0424

**T62265**



**Description:**

COUNTERSHAFT KIT (31-34-29-21-16T.)

**Packaging Unit:** 1

**OEM No :**

945 260 7224

**Model:**

G240-16/11,72-0,69

**EX / CROSS :**

**T15506**



**Description:**

COUPLING SLEEVE

**Packaging Unit:** 1

**OEM No :**

320 357 0053

**Model:**

HD 6/3 D-10  
HD 6/3 DG-10  
HL 7/015 D-13  
HL 7/07 D-10

**EX / CROSS :**

**T45215**



**Description:**

COVER

**Packaging Unit:** 5

**OEM No :**

970 261 0333

**Model:**

G60-6/9,20-1,00  
G85-6/6,70-0,83  
GO110-6/6,1-0,747

**EX / CROSS :**

970 261 0233

970 261 0633

**T49404**



**Description:**

COVER

**Packaging Unit:** 1

**OEM No :**

945 261 1033

**Model:**

G125-16/14,0  
G131-9  
G135-16/11,9  
G141-9  
G155-16/11,9  
G155-16/14,0  
G155-9/15,9  
G180-16/11,9  
G180-16/14,0  
G181-9  
G200-16/11,9  
G210-16/14,2-0,83  
G211-12 Klauen  
G211-16/17,03-1,0  
G221-9/10, 19-1,00  
G230-12 Klauen  
G231-16/17,03-1,0  
G240-16/11,72-0,69  
G241-16 Klauen  
G260-16/9,75-0,57  
G280-16 Klauen  
G281-12 Klauen  
G330-12/11,64-0,78  
GO210-8/11,8

**EX / CROSS :**

<p><b>T38823</b></p> 	<p><b>Description:</b> COVER FRONT</p> <p><b>OEM No :</b> 945 261 1118</p> <p><b>EX / CROSS :</b> 945 261 0818 945 261 0118</p>	<p><b>Packaging Unit:</b> 1</p> <p><b>Model:</b> G140-8 G181-9 G210-16/14,2-0,83 G211-16/17,03-1,0 G221-9/10,19-1,00 G230-16/14,2-0,83 G231-16/17,03-1,0 G240-16/11,72-0,69 G241-16 Klauen G260-16/9,75-0,57 G280-16 Klauen G281-12 Klauen</p> <p>G330-12/11,64-0,78</p>
<p><b>T16984</b></p> 	<p><b>Description:</b> COVER FRONT</p> <p><b>OEM No :</b> 343 281 1314</p> <p><b>EX / CROSS :</b></p>	<p><b>Packaging Unit:</b> 1</p> <p><b>Model:</b> W600-3W</p>
<p><b>T18838</b></p> 	<p><b>Description:</b> COVER FRONT</p> <p><b>OEM No :</b> 389 261 1920</p> <p><b>EX / CROSS :</b> 389 261 0520 389 261 0420</p>	<p><b>Packaging Unit:</b> 1</p> <p><b>Model:</b> G125-16/14,0 G135-16/11,9 G155-16/11,9 G155-16/14,0 G155-9/15,9 G180-16/11,9 G180-16/14,0 G200-16/11,9 G210-16/14,2-0,83 G240-16/11,72-0,69 GO210-8/11,8</p>
<p><b>T18839</b></p> 	<p><b>Description:</b> COVER FRONT</p> <p><b>OEM No :</b> 389 261 3318</p> <p><b>EX / CROSS :</b></p>	<p><b>Packaging Unit:</b> 1</p> <p><b>Model:</b> G125-16/14,0 G135-16/11,9 G155-16/11,9 G155-16/14,0 G155-9/15,9 G180-16/11,9 G180-16/14,0 G200-16/11,9 GO210-8/11,8</p>
<p><b>T18901</b></p> 	<p><b>Description:</b> COVER FRONT</p> <p><b>OEM No :</b> 389 261 4518</p> <p><b>EX / CROSS :</b></p>	<p><b>Packaging Unit:</b> 1</p> <p><b>Model:</b> G210-16/14,2-0,83 G240-16/11,72-0,69</p>



<p><b>T82414</b></p> 	<p><b>Description:</b> COVER FRONT</p> <p><b>OEM No :</b> 343 254 0216</p> <p><b>EX / CROSS :</b> 343 254 0016</p>	<p><b>Packaging Unit:</b> 1</p> <p><b>Model:</b></p>
<p><b>T49544</b></p> 	<p><b>Description:</b> CYLINDER</p> <p><b>OEM No :</b> 945 267 0819</p> <p><b>EX / CROSS :</b> 945 267 0719 945 267 0119 945 267 0019</p>	<p><b>Packaging Unit:</b> 1</p> <p><b>Model:</b> G100-12 G140-8 G200-16/11,9 G210-16/14,2-0,83 G211-12 Klauen G211-16/17,03-1,0 G230-12 Klauen G230-16/14,2-0,83 G231-16/17,03-1,0 G240-16/11,72-0,69 G241-16 Klauen G260-16/9,75-0,57 G280-16 Klauen G281-12 Klauen G330-12/11,64-0,78</p>
<p><b>T69388</b></p> 	<p><b>Description:</b> CYLINDER</p> <p><b>OEM No :</b> 001 260 4963</p> <p><b>EX / CROSS :</b></p>	<p><b>Packaging Unit:</b> 1</p> <p><b>Model:</b> G181-9 G221-9/10,19-1,00 G230-16/14,2-0,83 G231-16/17,03-1,0 G240-16/11,72-0,69</p>
<p><b>T19072</b></p> 	<p><b>Description:</b> CYLINDER</p> <p><b>OEM No :</b> 945 267 1119</p> <p><b>EX / CROSS :</b> 389 267 4219 389 267 1319 389 267 2919 389 267 1419</p>	<p><b>Packaging Unit:</b> 1</p> <p><b>Model:</b> G125-16/14,0 G135-16/11,9 G155-16/11,9 G155-16/14,0 G155-9/15,9 G180-16/11,9 G180-16/14,0 G200-16/11,9 G210-16/14,2-0,83 G240-16/11,72-0,69 GO210-8/11,8</p>
<p><b>T45486</b></p> 	<p><b>Description:</b> CYLINDER</p> <p><b>OEM No :</b> 389 267 2819</p> <p><b>EX / CROSS :</b> 389 267 2719 389 267 1519</p>	<p><b>Packaging Unit:</b> 1</p> <p><b>Model:</b> G125-16/14,0 G135-16/11,9 G155-16/11,9 G155-16/14,0 G180-16/11,9 G180-16/14,0 G200-16/11,9 G210-16/14,2-0,83 G240-16/11,72-0,69</p>

<p><b>T49125</b></p> 	<p><b>Description:</b> CYLINDER</p> <p><b>OEM No :</b> 945 267 1319</p> <p><b>EX / CROSS :</b> 945 267 1619</p>	<p><b>Packaging Unit:</b> 1</p> <p><b>Model:</b> G131-9 G161-9 G210-16/14,2-0,83 G211-16/17,03-1,0 G221-9/10,19-1,00 G230-16/14,2-0,83 G231-16/17,03-1,0 G240-16/11,72-0,69 G260-16/9,75-0,57</p>
<p><b>T67825</b></p> 	<p><b>Description:</b> CYLINDER</p> <p><b>OEM No :</b> 002 260 9563</p> <p><b>EX / CROSS :</b> 001 260 8463 003 260 3963</p>	<p><b>Packaging Unit:</b> 1</p> <p><b>Model:</b> G211-12 Klauen G230-16/14,2-0,83 G240-16/11,72-0,69 G330-12/11,64-0,78</p>
<p><b>T93709</b></p> 	<p><b>Description:</b> CYLINDER</p> <p><b>OEM No :</b> 001 295 6707</p> <p><b>EX / CROSS :</b></p>	<p><b>Packaging Unit:</b> 1</p> <p><b>Model:</b></p>
<p><b>T38061</b></p> 	<p><b>Description:</b> CYLINDRICAL ROLLER BEARING (35X80X23)</p> <p><b>OEM No :</b> 002 981 9501</p> <p><b>EX / CROSS :</b></p>	<p><b>Packaging Unit:</b> 1</p> <p><b>Model:</b></p>
<p><b>T65001</b></p> 	<p><b>Description:</b> CYLINDRICAL ROLLER BEARING (40X90X24,9)</p> <p><b>OEM No :</b> 007 981 7901</p> <p><b>EX / CROSS :</b> 007 981 7801 003 981 9001</p>	<p><b>Packaging Unit:</b> 1</p> <p><b>Model:</b> HD 4/02 DG-10 HD 4/02 DG-10 BRAZIL HD 4/02 GD-10 HD 4/03 D-10 HD 4/03 D-10 BRAZIL HH 4/04 D-12 HH 4/05 D-10 BRAZIL HH 4/07 DL-10 BRAZIL HL 4/01 - 10 HL 4/01 D-10 HL 4/01 D-10 BRAZIL HL 4/01 DL-10</p> <p>HL 4/01 DL-11,5 HL 4/01 L-10 HL 4/01-10 HL 4/035 D-10,6 HL 4/035 D-9,2 HL 4/038 D-10 HL 4/038 D-12 HL 4/038 D-9,4 HL 4/039 D-10 HL 4/039 D-12 HL 4/039 DL-12 HL 4/05 D-9,2</p>

**T70993**



**Description:**

CYLINDRICAL ROLLER BEARING (45X95X32)

**Packaging Unit:** 1

**OEM No :**

345 981 7501

**Model:**

**EX / CROSS :**

006 981 1901

003 981 1701

001 981 0001

000 981 9701

**T38077**



**Description:**

CYLINDRICAL ROLLER BEARING (60X110X22)

**Packaging Unit:** 1

**OEM No :**

008 981 9501

**Model:**

**EX / CROSS :**

**T38065**



**Description:**

CYLINDRICAL ROLLER BEARING (60X110X22)

**Packaging Unit:** 1

**OEM No :**

345 981 8101

**Model:**

**EX / CROSS :**

345 981 7401

001 981 1701

**T65132**



**Description:**

CYLINDRICAL ROLLER BEARING (70X110X20)

**Packaging Unit:** 1

**OEM No :**

007 981 0201

**Model:**

HD 4/02 DG-10  
HD 4/02 DG-10 BRAZIL  
HD 4/02 GD-10

**EX / CROSS :**

**T49258**



**Description:**

CYLINDRICAL ROLLER BEARING (80X26,5)

**Packaging Unit:** 1

**OEM No :**

002 981 7512

**Model:**

G60-6/9,20-1,00  
G71-6  
G85-6/6,70-0,83  
G90-6  
GO110-6/6,1-0,747

**EX / CROSS :**

010 981 4901

010 981 8401





T51411



**Description:**  
DIFF. CARRIER EMPTY

**Packaging Unit:** 1

**OEM No :**  
301 350 0727

**Model:**  
HL 5/60 DZ-10

**EX / CROSS :**

T08029



**Description:**  
DIFF. CARRIER GEAR (17T.)

**Packaging Unit:** 1

**OEM No :**  
354 353 0086

**Model:**  
HL 5/1 Z-10  
HL 5/2 DZ-10 BRAZIL  
HL 5/2 Z(S)-10 BRAZIL  
HL 5/2 Z-10  
HL 5/2 ZL-10  
HL 5/2 ZS-10  
HL 5/60 DZ-10  
HO 5/4 Z-10  
HO 5/8 DZ-10

**EX / CROSS :**  
327 353 0586

T18450



**Description:**  
DIFF. CARRIER GEAR (17T.)

**Packaging Unit:** 1

**OEM No :**  
(355 350 0254/G)

**Model:**

**EX / CROSS :**

T08998



**Description:**  
DIFF. CARRIER GEAR (17T.)

**Packaging Unit:** 1

**OEM No :**  
(346 586 0135/G)

**Model:**

**EX / CROSS :**

T09797



**Description:**  
DIFF. CARRIER GEAR (18T.)





**Packaging Unit:** 1

**OEM No :**  
(346 586 0035/G)

**Model:**

**EX / CROSS :**



<p><b>T15769</b></p> 	<p><b>Description:</b> DIFF. CARRIER GEAR (18T.)</p> <p><b>OEM No :</b> (355 350 0354/G)</p> <p><b>EX / CROSS :</b></p>	<p><b>Packaging Unit:</b> 1</p> <p><b>Model:</b></p>																								
<p><b>T51377</b></p> 	<p><b>Description:</b> DIFF. CARRIER GEAR (24T.)</p> <p><b>OEM No :</b> TAS51377</p> <p><b>EX / CROSS :</b> (355 350 0454/G)</p>	<p><b>Packaging Unit:</b> 1</p> <p><b>Model:</b></p>																								
<p><b>T19657</b></p> 	<p><b>Description:</b> DIFF. CARRIER GEAR (24T.)</p> <p><b>OEM No :</b> (652 350 0054/G)</p> <p><b>EX / CROSS :</b></p>	<p><b>Packaging Unit:</b> 1</p> <p><b>Model:</b></p> <table border="0"> <tr> <td>HD 7/016 DG-13</td> <td>HL 7/015 DL-13</td> </tr> <tr> <td>HD 7/016 DSG-13</td> <td>HL 7/015 DS-13</td> </tr> <tr> <td>HD 7/055 DCGS-13</td> <td>HL 7/021 D-10</td> </tr> <tr> <td>HD 7/056 DGS-13</td> <td>HL 7/021 DL-10</td> </tr> <tr> <td>HD 7/056 DGS-16</td> <td>HL 7/024 D-12,3</td> </tr> <tr> <td>HD 7/09 DG-10</td> <td>HL 7/024 DL-12,3</td> </tr> <tr> <td>HD 7/19 DG-13</td> <td>HL 7/050 DCS-11,5</td> </tr> <tr> <td>HD 7/2 DG-10</td> <td>HL 7/050 DCS-13</td> </tr> <tr> <td>HD 7/5 DG-10</td> <td>HL 7/055 DCS-13</td> </tr> <tr> <td>HL 7/013 D-16</td> <td>HL 7/07 D-10</td> </tr> <tr> <td>HL 7/015 D-13</td> <td>HL 7/07 D-11,5</td> </tr> <tr> <td>HL 7/015 D-13 TURKEY</td> <td>HL 7/07 DL-10</td> </tr> </table>	HD 7/016 DG-13	HL 7/015 DL-13	HD 7/016 DSG-13	HL 7/015 DS-13	HD 7/055 DCGS-13	HL 7/021 D-10	HD 7/056 DGS-13	HL 7/021 DL-10	HD 7/056 DGS-16	HL 7/024 D-12,3	HD 7/09 DG-10	HL 7/024 DL-12,3	HD 7/19 DG-13	HL 7/050 DCS-11,5	HD 7/2 DG-10	HL 7/050 DCS-13	HD 7/5 DG-10	HL 7/055 DCS-13	HL 7/013 D-16	HL 7/07 D-10	HL 7/015 D-13	HL 7/07 D-11,5	HL 7/015 D-13 TURKEY	HL 7/07 DL-10
HD 7/016 DG-13	HL 7/015 DL-13																									
HD 7/016 DSG-13	HL 7/015 DS-13																									
HD 7/055 DCGS-13	HL 7/021 D-10																									
HD 7/056 DGS-13	HL 7/021 DL-10																									
HD 7/056 DGS-16	HL 7/024 D-12,3																									
HD 7/09 DG-10	HL 7/024 DL-12,3																									
HD 7/19 DG-13	HL 7/050 DCS-11,5																									
HD 7/2 DG-10	HL 7/050 DCS-13																									
HD 7/5 DG-10	HL 7/055 DCS-13																									
HL 7/013 D-16	HL 7/07 D-10																									
HL 7/015 D-13	HL 7/07 D-11,5																									
HL 7/015 D-13 TURKEY	HL 7/07 DL-10																									
<p><b>T20413</b></p> 	<p><b>Description:</b> DIFF. CARRIER GEAR (26T.)</p> <p><b>OEM No :</b> (653 350 0054/G)</p> <p><b>EX / CROSS :</b></p>	<p><b>Packaging Unit:</b> 1</p> <p><b>Model:</b></p>																								
<p><b>T18449</b></p> 	<p><b>Description:</b> DIFF. CARRIER GEAR KIT (17T.)</p> <p><b>OEM No :</b> 355 350 0254</p> <p><b>EX / CROSS :</b> 355 350 0054</p>	<p><b>Packaging Unit:</b> 1</p> <p><b>Model:</b></p> <table border="0"> <tr> <td>HD 7/19 DG-13</td> </tr> <tr> <td>HD 7/2 DG-10</td> </tr> <tr> <td>HD 7/5 DG-10</td> </tr> <tr> <td>HL 7/1 DL-10</td> </tr> <tr> <td>HL 7/18 D-13</td> </tr> <tr> <td>HL 7/3 D-10</td> </tr> </table>	HD 7/19 DG-13	HD 7/2 DG-10	HD 7/5 DG-10	HL 7/1 DL-10	HL 7/18 D-13	HL 7/3 D-10																		
HD 7/19 DG-13																										
HD 7/2 DG-10																										
HD 7/5 DG-10																										
HL 7/1 DL-10																										
HL 7/18 D-13																										
HL 7/3 D-10																										

**T08996**



**Description:**

DIFF. CARRIER GEAR KIT (17T.)

**Packaging Unit:** 1

**OEM No :**

346 586 0135

**Model:**

HD 7/016 DG-13  
HD 7/016 DSG-13  
HD 7/09 DG-10  
HL 7/013 D-16  
HL 7/015 D-13  
HL 7/015 DL-13  
HL 7/015 DS-13  
HL 7/021 D-10  
HL 7/07 D-10  
HL 7/07 D-11,5  
HL 7/07 DL-10  
HL 7/07 DL-11,5

HL 7/07 DS-10

**EX / CROSS :**

**T88695**



**Description:**

DIFF. CARRIER GEAR KIT (17T.)

**Packaging Unit:** 1

**OEM No :**

346 350 0654

**Model:**

HD 7/016 DG-13  
HD 7/016 DSG-13  
HD 7/09 DG-10  
HL 7/015 D-13  
HL 7/015 D-13 TURKEY  
HL 7/02 DL-10  
HL 7/021 D-10  
HL 7/021 DL-10  
HL 7/024 D-12,3  
HL 7/024 DL-12,3

**EX / CROSS :**

346 586 0134

346 350 0454

**T09795**



**Description:**

DIFF. CARRIER GEAR KIT (18T.)

**Packaging Unit:** 1

**OEM No :**

346 350 0554

**Model:**

HD 7/014 DG-16  
HD 7/014 DGS-16 TURKEY  
HD 7/016 DG-13  
HL 7/013 D-16  
HL 7/013 DS-16 TURKEY  
HL 7/015 D-13  
HL 7/021 D-10  
HL 7/024 D-12,3  
HL 7/024 DL-12,3

**EX / CROSS :**

**T15768**



**Description:**

DIFF. CARRIER GEAR KIT (18T.)

**Packaging Unit:** 1

**OEM No :**

355 350 0354

**Model:**

HD 7/11 DG-9  
HD 7/19 DG-13  
HD 7/19 DG-13 TURKEY  
HD 7/19 DGS-13 TURKEY  
HD 7/19 DSG-13  
HD 7/2 DG-10  
HD 7/2 DLG-10  
HD 7/2 DSG-10  
HD 7/5 DG-10  
HL 7/1 D-10  
HL 7/1 DL-10  
HL 7/1 L-10

HL 7/1 S-10  
HL 7/1-10  
HL 7/10 D-9  
HL 7/18 D-13  
HL 7/18 D-13 TURKEY  
HL 7/18 DS-13  
HL 7/18 DS-13 TURKEY  
HL 7/24 DS-9  
HL 7/26 D-11,5  
HL 7/26 D-12,3  
HL 7/26 DL-12,3  
HL 7/3 D-10

**EX / CROSS :**

**T51370**



**Description:**

DIFF. CARRIER GEAR KIT (24T.)

**Packaging Unit:** 1

**OEM No :**

355 350 0454

**Model:**

**EX / CROSS :**



**T20412**



**Description:**

DIFF. CARRIER GEAR KIT (26T.)

**Packaging Unit:** 1

**OEM No :**

653 350 0054

**Model:**

HD 7/016 DG-13	HL 7/021 DL-10
HD 7/016 DSG-13	HL 7/024 D-12,3
HD 7/09 DG-10	HL 7/024 DL-12,3
HD 7/19 DG-13	HL 7/07 D-10
HD 7/2 DG-10	HL 7/07 D-11,5
HD 7/5 DG-10	HL 7/07 DL-10
HL 7/013 D-16	HL 7/07 DL-11,5
HL 7/015 D-13	HL 7/07 DS-10
HL 7/015 DL-13	HL 7/07 DL-10
HL 7/015 DS-13	HL 7/18 D-13
HL 7/02 DL-10	HL 7/26 DL-12,3
HL 7/021 D-10	HL 7/3 D-10

**EX / CROSS :**

**T81023**



**Description:**

DIFF. CARRIER GEAR KIT 1 SET (24T.)

**Packaging Unit:** 1

**OEM No :**

652 350 0054/1

**Model:**

**EX / CROSS :**

**T19656**



**Description:**

DIFF. CARRIER GEAR KIT 5 SETS (24T.)

**Packaging Unit:** 1

**OEM No :**

652 350 0054

**Model:**

HD 7/016 DG-13	HL 7/015 DL-13
HD 7/016 DSG-13	HL 7/015 DS-13
HD 7/055 DCGS-13	HL 7/02 DL-10
HD 7/056 DGS-13	HL 7/021 D-10
HD 7/056 DGS-16	HL 7/021 DL-10
HD 7/09 DG-10	HL 7/024 D-12,3
HD 7/19 DG-13	HL 7/024 DL-12,3
HD 7/2 DG-10	HL 7/050 DCS-11,5
HD 7/5 DG-10	HL 7/050 DCS-13
HL 7/013 D-16	HL 7/055 DCS-13
HL 7/015 D-13	HL 7/07 D-10
HL 7/015 D-13 TURKEY	HL 7/07 D-11,5

**EX / CROSS :**

**T19077**



**Description:**

DIFF. CARRIER HUB (48T.)

**Packaging Unit:** 1

**OEM No :**

346 354 2409

**Model:**

HL 7/07 D-10  
HL 7/07 DL-10  
HL 7/3 D-10

**EX / CROSS :**

**T11229**



**Description:**

DIFF. CARRIER HUB (56-46T.)

**Packaging Unit:** 1

**OEM No :**

355 354 1809

**Model:**

AL 7/1 D-7	HL 7/013 D-16
AL 7/1 DS-7	HL 7/013 DS-16 TURKEY
AL 7/5 D-7	HL 7/015 D-13
AL 7/8 D-8	HL 7/021 D-10
HD 7/014 DGS-16	HL 7/024 D-12,3
HD 7/014 DGS-16 TURKEY	HL 7/024 DL-12,3
HD 7/11 DG-9	HL 7/1 D-10
HD 7/19 DG-13	HL 7/1 DL-10
HD 7/2 DG-10	HL 7/1 L-10
HD 7/2 DLG-10	HL 7/1 S-10
HD 7/2 DSG-10	HL 7/1-10
HD 7/5 DG-10	HL 7/10 D-9

**EX / CROSS :**

355 354 0709

<p><b>T16987</b></p> 	<p><b>Description:</b> DIFF. CARRIER HUB (57-46T.)</p> <p><b>OEM No :</b> 346 354 3009</p> <p><b>EX / CROSS :</b></p>	<p><b>Packaging Unit:</b> 1</p> <p><b>Model:</b> HD 7/016 DG-13 HD 7/19 DG-13 HL 7/015 D-13 HL 7/015 D-13 TURKEY HL 7/015 DL-13 HL 7/015 DS-13 HL 7/18 D-13</p>
<p><b>T09241</b></p> 	<p><b>Description:</b> DIFF. CARRIER HUB (57T.)</p> <p><b>OEM No :</b> 346 354 0909</p> <p><b>EX / CROSS :</b></p>	<p><b>Packaging Unit:</b> 1</p> <p><b>Model:</b> AL 7/1 D-7 AL 7/5 D-7 HD 7/19 DG-13 HD 7/2 DG-10 HD 7/5 DG-10 HL 7/015 D-13 HL 7/024 D-12,3 HL 7/024 DL-12,3 HL 7/07 D-11,5 HL 7/07 DL-11,5 HL 7/1 DL-10 HL 7/3 D-10</p>
<p><b>T19213</b></p> 	<p><b>Description:</b> DIFF. CARRIER HUB (57T.)</p> <p><b>OEM No :</b> 346 354 3109</p> <p><b>EX / CROSS :</b></p>	<p><b>Packaging Unit:</b> 1</p> <p><b>Model:</b> AL 7/1 D-7 AL 7/5 D-7 HD 7/016 DG-13 HD 7/016 DSG-13 HD 7/09 DG-10 HD 7/19 DG-13 HD 7/2 DG-10 HD 7/5 DG-10 HL 7/013 D-16 HL 7/015 D-13 HL 7/02 DL-10 HL 7/021 D-10 HL 7/021 DL-10 HL 7/024 D-12,3 HL 7/024 DL-12,3 HL 7/07 D-10 HL 7/07 D-11,5 HL 7/07 DL-10 HL 7/07 DL-11,5 HL 7/07 DS-10 HL 7/1 DL-10 HL 7/3 D-10 HO 7/01 DLS-10 HO 7/02 DLM-10</p>
<p><b>T08995</b></p> 	<p><b>Description:</b> DIFF. CARRIER HUB (57T.)</p> <p><b>OEM No :</b> 346 354 1109</p> <p><b>EX / CROSS :</b></p>	<p><b>Packaging Unit:</b> 1</p> <p><b>Model:</b> HD 7/016 DG-13 HD 7/19 DG-13 HL 7/015 D-13 HL 7/015 DL-13 HL 7/18 D-13</p>
<p><b>T39259</b></p> 	<p><b>Description:</b> DIFF. CARRIER HUB (75T.)</p> <p><b>OEM No :</b> 346 354 9709</p> <p><b>EX / CROSS :</b></p>	<p><b>Packaging Unit:</b> 1</p> <p><b>Model:</b> HD 7/055 DCGS-13 HD 7/056 DGS-13 HD 7/056 DGS-16 HD 7/55 DCGS-13 HD 7/56 DGS-13 HL 7/050 DCS-11,5 HL 7/050 DCS-13 HL 7/055 DCS-13</p>

**T19882**



**Description:**  
DIFF. CARRIER HUB (85T.)

**Packaging Unit:** 1

**OEM No :**  
346 354 5709

**Model:**  
HD 7/016 DG-13  
HD 7/19 DG-13  
HL 7/015 D-13  
HL 7/015 D-13 TURKEY  
HL 7/015 DL-13  
HL 7/015 DS-13  
HL 7/18 D-13

**EX / CROSS :**

**T19214**



**Description:**  
DIFF. CARRIER HUB (89T.)

**Packaging Unit:** 1

**OEM No :**  
346 354 4209

**Model:**  
HD 7/016 DG-13  
HD 7/19 DG-13  
HL 7/015 D-13  
HL 7/015 DL-13  
HL 7/015 DS-13  
HL 7/18 D-13

**EX / CROSS :**

**T85315**



**Description:**  
DIFF. CARRIER SUPPORT

**Packaging Unit:** 1

**OEM No :**  
346 350 7433A

**Model:**

**EX / CROSS :**

**T08028**



**Description:**  
DIFF. CARRIER W/GEARS

**Packaging Unit:** 1

**OEM No :**  
354 350 0823

**Model:**  
HL 5/1 Z-10  
HL 5/2 DZ-10 BRAZIL  
HL 5/2 Z(S)-10 BRAZIL  
HL 5/2 Z-10  
HL 5/2 ZL-10  
HL 5/2 ZS-10  
HO 5/4 Z-10  
HO 5/8 DZ-10

**EX / CROSS :**  
354 350 0123  
350 350 0223  
345 350 1323  
302 350 2023

**T51389**



**Description:**  
DIFF. CARRIER W/GEARS

**Packaging Unit:** 1

**OEM No :**  
386 350 7823

**Model:**  
HL 5/60 DZ-10

**EX / CROSS :**





**T12314**



**Description:**  
DIFF. CASE ASSEMBLY

**Packaging Unit:** 1

**OEM No :**  
346 350 8123

**Model:**  
HD 7/014 DG-16  
HD 7/014 DGS-16  
HD 7/014 DGS-16 TURKEY  
HD 7/016 DG-13  
HD 7/016 DSG-13  
HD 7/09 DG-10  
HL 7/013 D-16  
HL 7/013 DS-16 TURKEY  
HL 7/015 D-13  
HL 7/015 D-13 TURKEY  
HL 7/015 DL-13  
HL 7/015 DS-13  
HL 7/02 DL-10  
HL 7/021 D-10  
HL 7/021 DL-10  
HL 7/021 DS-10  
HL 7/024 D-12,3  
HL 7/024 DL-12,3  
HL 7/050 DCS-11,5  
HL 7/050 DCS-13  
HL 7/052 DS-13  
HL 7/07 D-10  
HL 7/07 D-11,5  
HL 7/07 DL-10

**EX / CROSS :**

**T85345**



**Description:**  
DIFF. CASE ASSEMBLY

**Packaging Unit:** 1

**OEM No :**  
944 350 0623

**Model:**  
HD 7/55 DCGS-13  
HD 7/56 DGS-13

**EX / CROSS :**

**T12318**



**Description:**  
DIFF. CASE ASSEMBLY

**Packaging Unit:** 1

**OEM No :**  
387 350 1323

**Model:**  
AL 7/1 D-7  
AL 7/5 D-7  
HD 7/11 DG-9  
HD 7/19 DG-13  
HD 7/19 DGS-13  
HD 7/19 DSG-13  
HD 7/2 DG-10  
HD 7/2 DLG-10  
HD 7/2 DSG-10  
HD 7/5 DG-10  
HL 7/1 D-10  
HL 7/1 DL-10  
HL 7/1 L-10  
HL 7/1 S-10  
HL 7/1-10  
HL 7/10 D-9  
HL 7/18 D-13  
HL 7/18 DS-13  
HL 7/24 DS-9  
HL 7/3 D-10  
HL 7/3 DL-10  
HL 7/3 DS-10  
HL 7/4 D-10  
HO 7/8 DL-10

**EX / CROSS :**  
355 350 7623

**T12320**



**Description:**  
DIFF. CASE ASSEMBLY

**Packaging Unit:** 1

**OEM No :**  
387 350 5923

**Model:**  
AL 7/1 D-7  
AL 7/1 DS-7  
AL 7/5 D-7  
AL 7/8 D-8  
HD 7/11 DG-9  
HD 7/19 DG-13  
HD 7/19 DG-13 TURKEY  
HD 7/19 DGS-13  
HD 7/19 DGS-13 TURKEY  
HD 7/19 DSG-13  
HD 7/2 DG-10  
HD 7/2 DLG-10  
HD 7/2 DSG-10  
HD 7/5 DG-10  
HL 7/1 D-10  
HL 7/1 DL-10  
HD 7/2 DSG-10  
HD 7/5 DG-10  
HL 7/1 D-10  
HL 7/1 S-10  
HL 7/1-10  
HL 7/10 D-9  
HL 7/10 D-13  
HL 7/18 D-13 TURKEY  
HL 7/18 DS-13  
HL 7/18 DS-13 TURKEY

**EX / CROSS :**  
387 350 1523

**T19021**



**Description:**  
DIFF. CASE ASSEMBLY

**Packaging Unit:** 1

**OEM No :**  
942 350 2123

**Model:**  
HL 7/055 DCS-13

**EX / CROSS :**



**T38926**



**Description:**  
DIFF. CASE ASSEMBLY

**Packaging Unit:** 1

**OEM No :**  
000 350 8023

**Model:**  
HD 7/055 DCGS-13  
HD 7/056 DGS-13  
HD 7/056 DGS-16

**EX / CROSS :**  
942 350 0064

**T58335**



**Description:**  
DIFF. CASE ASSEMBLY

**Packaging Unit:** 1

**OEM No :**  
944 350 0523

**Model:**  
HL 7/233  
HL 7/55 DCS-13  
HL 7/56 DS-13

**EX / CROSS :**

**T71055**



**Description:**  
DIFF. CASE ASSEMBLY

**Packaging Unit:** 1

**OEM No :**  
948 350 0023

**Model:**

**EX / CROSS :**

**T40136**



**Description:**  
DIFF. CASE ASSEMBLY

**Packaging Unit:** 1

**OEM No :**  
000 350 7123

**Model:**  
HH 4/08 DL-11 (DETROIT  
AXLE)  
HL 4/63 DL-10 (DETROIT  
AXLE)

**EX / CROSS :**

**T91097**



**Description:**  
DIFF. CASE ASSEMBLY (REINFORCED SPIDER)

**Packaging Unit:** 1

**OEM No :**  
948 350 0023R

**Model:**

**EX / CROSS :**



<p><b>T70978</b></p> 	<p><b>Description:</b> DIFF. CASE EMPTY</p> <p><b>OEM No :</b> 948 353 0001</p> <p><b>EX / CROSS :</b> 948 353 0101</p>	<p><b>Packaging Unit:</b> 1</p> <p><b>Model:</b> HL 6/1 DC(L,S)-13 (REINFORCED) HL 6/1 DC(LC)-13 (OLD VERSION) HL 6/1 DC(LC)-13 (REINFORCED) HL 6/3 DC(L,S)-13 (OLD VERSION) HO 6/1 DCL(S)-13 HO 6/2 DCL(S)-13 HO 6/4 DCL(S)-13 HO 6/5 DCL(S)-13 HO 6/6 DCL(S)-13</p>
<p><b>T60943</b></p> 	<p><b>Description:</b> DIFF. CASE EMPTY</p> <p><b>OEM No :</b> TAS60943</p> <p><b>EX / CROSS :</b> 944 350 0623/CASE</p>	<p><b>Packaging Unit:</b> 1</p> <p><b>Model:</b> HD 7/55 DCGS-13 HD 7/56 DGS-13</p>
<p><b>T18707</b></p> 	<p><b>Description:</b> DIFF. CASE EMPTY</p> <p><b>OEM No :</b> (942 350 2223/CASE)</p> <p><b>EX / CROSS :</b></p>	<p><b>Packaging Unit:</b> 1</p> <p><b>Model:</b></p>
<p><b>T12311</b></p> 	<p><b>Description:</b> DIFF. CASE EMPTY</p> <p><b>OEM No :</b> 346 350 0427</p> <p><b>EX / CROSS :</b></p>	<p><b>Packaging Unit:</b> 1</p> <p><b>Model:</b> HD 7/014 DG-16 HD 7/014 DGS-16 HD 7/014 DGS-16 TURKEY HD 7/016 DG-13 HD 7/016 DSG-13 HD 7/09 DG-10 HL 7/013 D-16 HL 7/013 DS-16 TURKEY HL 7/015 D-13 HL 7/015 D-13 TURKEY HL 7/015 DL-13 HL 7/015 DS-13</p> <p>HL 7/02 DL-10 HL 7/021 D-10 HL 7/021 DL-10 HL 7/021 DS-10 HL 7/024 D-12,3 HL 7/024 DL-12,3 HL 7/07 D-10 HL 7/07 D-11,5 HL 7/07 DL-10 HL 7/07 DL-11,5 HL 7/07 DS-10 HO 7/01 DL-10</p>
<p><b>T45738</b></p> 	<p><b>Description:</b> DIFF. CASE EMPTY</p> <p><b>OEM No :</b> 942 353 0401</p> <p><b>EX / CROSS :</b></p>	<p><b>Packaging Unit:</b> 1</p> <p><b>Model:</b></p>





T19211



**Description:**

DIFF. CASE EMPTY (2 HALVES)

**Packaging Unit:** 1

**OEM No :**

(346 350 8223/CASE)

**Model:**

**EX / CROSS :**

T75821



**Description:**

DIFF. CASE EMPTY HALF

**Packaging Unit:** 1

**OEM No :**

TAS75821

**Model:**

**EX / CROSS :**

T75820



**Description:**

DIFF. CASE EMPTY HALF

**Packaging Unit:** 1

**OEM No :**

TAS75820

**Model:**

**EX / CROSS :**

T75817



**Description:**

DIFF. CASE EMPTY HALF

**Packaging Unit:** 1

**OEM No :**

TAS75817

**Model:**

**EX / CROSS :**

T75818



**Description:**

DIFF. CASE EMPTY HALF

**Packaging Unit:** 1

**OEM No :**

TAS75818

**Model:**

**EX / CROSS :**



**T14256**



**Description:**

DIFF. CASE EMPTY W/SCREW

**Packaging Unit:** 1

**OEM No :**

TAS14256

**Model:**

**EX / CROSS :**

(387 350 5923/CASE)

**T15307**



**Description:**

DIFF. CASE EMPTY W/SCREW

**Packaging Unit:** 1

**OEM No :**

346 350 2327

**Model:**

HD 7/014 DG-16  
HD 7/014 DGS-16  
HD 7/014 DGS-16 TURKEY  
HD 7/016 DG-13  
HD 7/016 DSG-13  
HD 7/09 DG-10

**EX / CROSS :**

346 350 0527

**T14937**



**Description:**

DIFF. CASE EMPTY W/SCREW

**Packaging Unit:** 1

**OEM No :**

355 350 1827

**Model:**

HD 4/02 DG-10  
HD 4/02 DG-10 BRAZIL  
HD 4/02 GD-10  
HD 4/021 GS-10 BRAZIL  
HD 4/21 DG-10  
HD 4/21 G-10  
HD 4/21 G-10 BRAZIL  
HD 4/22-10  
HD 7/11 DG-9  
HD 7/19 DG-13  
HD 7/19 DG-13 TURKEY  
HD 7/19 DGS-13  
HD 7/19 DSG-13  
HD 7/2 DG-10  
HD 7/2 DLG-10  
HD 7/2 DSG-10  
HD 7/5 DG-10  
HD 7/19 DGS-13 TURKEY

**EX / CROSS :**

355 350 0327

**T09075**



**Description:**

DIFF. CASE EMPTY W/SCREW

**Packaging Unit:** 1

**OEM No :**

355 350 0227

**Model:**

AL 7/1 D-7  
AL 7/5 D-7  
HD 7/11 DG-9  
HD 7/19 DG-13  
HD 7/19 DGS-13  
HD 7/19 DSG-13  
HD 7/2 DG-10  
HD 7/2 DLG-10  
HD 7/2 DSG-10  
HD 7/5 DG-10  
HL 7/1 D-10  
HL 7/1 DL-10  
HL 7/1 L-10  
HL 7/1 S-10  
HL 7/1-10  
HL 7/10 D-9  
HL 7/18 D-13  
HL 7/18 DS-13  
HL 7/24 DS-9  
HL 7/3 D-10  
HL 7/3 DL-10  
HL 7/3 DS-10  
HL 7/4 D-10  
HO 7/8 DL-10

**EX / CROSS :**

**T18711**



**Description:**

DIFF. CASE GUARD RING

**Packaging Unit:** 1

**OEM No :**

(942 350 2223/R)

**Model:**

**EX / CROSS :**



**T05826**



**Description:**

DIFF. DRIVE PINION (FOR SET 6-41)

**Packaging Unit:** 1

**OEM No :**

(312 350 1739/PINION)

**Model:**

**EX / CROSS :**

**T14909**



**Description:**

DIFF. FORK

**Packaging Unit:** 1

**OEM No :**

355 353 0234

**Model:**

HD 7/014 DG-16  
HD 7/014 DGS-16  
HD 7/014 DGS-16 TURKEY  
HD 7/016 DG-13  
HD 7/016 DSG-13  
HD 7/09 DG-10  
HD 7/11 DG-9  
HD 7/19 DG-13  
HD 7/19 DG-13 TURKEY  
HD 7/19 DGS-13  
HD 7/19 DGS-13 TURKEY  
HD 7/19 DSG-13  
HD 7/19 DSG-13  
HD 7/2 DG-10  
HD 7/2 DLG-10  
HD 7/2 DSG-10  
HD 7/5 DG-10

**EX / CROSS :**

**T53218**



**Description:**

DIFF. FORK

**Packaging Unit:** 1

**OEM No :**

942 353 0134

**Model:**

HD 7/055 DCGS-13  
HD 7/056 DGS-13  
HD 7/056 DGS-16  
HD 7/55 DCGS-13  
HD 7/56 DGS-13

**EX / CROSS :**

**T08944**



**Description:**

DIFF. GEAR (10T.)

**Packaging Unit:** 1

**OEM No :**

315 354 0610

**Model:**

HD 6/3 D-10  
HD 6/3 DG-10

**EX / CROSS :**

315 354 0510

**T15508**



**Description:**

DIFF. GEAR (11T.)

**Packaging Unit:** 1

**OEM No :**

326 354 1410

**Model:**

HD 6/3 D-10  
HD 6/3 DG-10  
HL 7/015 D-13  
HL 7/07 D-10

**EX / CROSS :**

326 354 0910





**T17788**



**Description:**  
DIFF. GEAR (15T.)

**Packaging Unit:** 1

**OEM No :**  
366 354 3510

**Model:**  
HL 6/4 D-13

**EX / CROSS :**  
366 354 2610

**T61862**



**Description:**  
DIFF. GEAR (26-29T.)

**Packaging Unit:** 1

**OEM No :**  
944 353 0085

**Model:**  
HD 7/55 DCGS-13  
HD 7/56 DGS-13

**EX / CROSS :**

**T61859**



**Description:**  
DIFF. GEAR (26T.-31SPL.)

**Packaging Unit:** 1

**OEM No :**  
944 353 0385

**Model:**  
HD 7/55 DCGS-13  
HD 7/56 DGS-13

**EX / CROSS :**

**T15507**



**Description:**  
DIFF. GEAR (28T.)

**Packaging Unit:** 1

**OEM No :**  
326 354 1012

**Model:**  
HD 6/3 D-10  
HD 6/3 DG-10  
HL 7/015 D-13  
HL 7/07 D-10

**EX / CROSS :**  
326 354 0512

**T12316**



**Description:**  
DIFF. GEAR (28T.)

**Packaging Unit:** 1

**OEM No :**  
355 353 0085

**Model:**  
HD 7/11 DG-9  
HD 7/19 DG-13  
HD 7/19 DG-13 TURKEY  
HD 7/19 DGS-13  
HD 7/19 DGS-13 TURKEY  
HD 7/19 DSG-13  
HD 7/2 DG-10  
HD 7/2 DLG-10  
HD 7/2 DSG-10  
HD 7/5 DG-10  
HL 7/050 DCS-11,5  
HL 7/050 DCS-13

**EX / CROSS :**



T08945



**Description:**  
DIFF. GEAR (29T.)

**Packaging Unit:** 1

**OEM No :**  
326 354 1112

**Model:**  
HD 6/3 D-10  
HD 6/3 DG-10

**EX / CROSS :**  
326 354 0612

T08969



**Description:**  
DIFF. GEAR (30-31T.)

**Packaging Unit:** 1

**OEM No :**  
346 353 0085

**Model:**  
HD 7/014 DG-16  
HD 7/014 DGS-16  
HD 7/014 DGS-16 TURKEY  
HD 7/016 DG-13  
HD 7/016 DSG-13  
HD 7/09 DG-10

**EX / CROSS :**

T60232



**Description:**  
DIFF. GEAR (31-35T.)

**Packaging Unit:** 1

**OEM No :**  
942 353 0215

**Model:**  
HD 7/055 DCGS-13  
HD 7/056 DGS-13  
HD 7/056 DGS-16

**EX / CROSS :**

T17787



**Description:**  
DIFF. GEAR (34T.)

**Packaging Unit:** 1

**OEM No :**  
366 354 2512

**Model:**  
HL 6/4 D-13

**EX / CROSS :**

T20687



**Description:**  
DIFF. GEAR (37T.)

**Packaging Unit:** 1

**OEM No :**  
942 353 0315

**Model:**  
HD 7/055 DCGS-13  
HD 7/056 DGS-13  
HD 7/056 DGS-16

**EX / CROSS :**



<p><b>T00093</b></p> 	<p><b>Description:</b> DIFF. GEAR AND PINION (10-41)</p> <p><b>OEM No :</b> 309 350 1439</p> <p><b>EX / CROSS :</b> 309 350 1139 309 350 0839 309 350 0239</p>	<p><b>Packaging Unit:</b> 1</p> <p><b>Model:</b></p>
<p><b>T53556</b></p> 	<p><b>Description:</b> DIFF. GEAR AND PINION (10-43)</p> <p><b>OEM No :</b> 674 350 0339</p> <p><b>EX / CROSS :</b> 688 350 0039 688 350 0239 378 350 0039 318 350 1439</p>	<p><b>Packaging Unit:</b> 1</p> <p><b>Model:</b> HL 2/11 D-5,8 HL 2/13 D-6,4 HL 2/14 D-6,9 HL 2/15 S-5,8 HL 2/15-5,8 HL 2/15-5,9 BRAZIL HL 2/16-4,7 BRAZIL HL 2/17-5,9 BRAZIL HL 2/5-4,5 HL 2/5-4,5 BRAZIL HL 2/9-4,7 HL 2/9-4,7 TURKEY</p>
<p><b>T59285</b></p> 	<p><b>Description:</b> DIFF. GEAR AND PINION (11-41)</p> <p><b>OEM No :</b> 668 350 0739</p> <p><b>EX / CROSS :</b> 668 350 0439 668 350 0139</p>	<p><b>Packaging Unit:</b> 1</p> <p><b>Model:</b></p>
<p><b>T09672</b></p> 	<p><b>Description:</b> DIFF. GEAR AND PINION (12-27)</p> <p><b>OEM No :</b> 346 350 6239</p> <p><b>EX / CROSS :</b> 346 350 4239 346 350 1839</p>	<p><b>Packaging Unit:</b> 1</p> <p><b>Model:</b> HL 7/015 D-13</p>
<p><b>T09673</b></p> 	<p><b>Description:</b> DIFF. GEAR AND PINION (12-27)</p> <p><b>OEM No :</b> 346 350 3039</p> <p><b>EX / CROSS :</b></p>	<p><b>Packaging Unit:</b> 1</p> <p><b>Model:</b></p>





**T54693**



**Description:**

DIFF. GEAR AND PINION (12-40)

**Packaging Unit:** 1

**OEM No :**

300 350 0039

**Model:**

HO 4/01 DL-10  
HO 4/01 DL-10 BRAZIL  
HO 4/01 DL-10 TURKEY  
HO 4/01 DL-11,5  
HO 4/02 CL-11,5

**EX / CROSS :**

652 350 0239

**T15463**



**Description:**

DIFF. GEAR AND PINION (12-44)

**Packaging Unit:** 1

**OEM No :**

652 350 0339

**Model:**

**EX / CROSS :**

301 350 2439

**T70053**



**Description:**

DIFF. GEAR AND PINION (12-47)

**Packaging Unit:** 1

**OEM No :**

301 350 2339

**Model:**

HD 4/03 D-10  
HD 4/03 D-10 BRAZIL  
HH 4/07 DL-10 BRAZIL  
HL 4/01 D-10  
HL 4/01 D-10 BRAZIL  
HL 4/01 DL-10  
HL 4/035 D-10,6  
HL 4/038 D-10  
HL 4/038 D-12  
HL 4/038 D-9,4  
HL 4/039 D-10  
HL 4/039 D-12  
HL 4/039 DL-12  
HL 4/06 D-12  
HL 4/06 DL-12  
HL 4/07 D-9,4  
HO 4/01 D-10 TURKEY  
HO 4/01 DL-10 BRAZIL  
HO 4/01 DL-10 TURKEY

**EX / CROSS :**

**T61195**



**Description:**

DIFF. GEAR AND PINION (13-37)

**Packaging Unit:** 1

**OEM No :**

TAS61195

**Model:**

HL 6/1 DC(LC)-13 (OLD  
VERSION)  
HL 6/3 DC(L,S)-13 (OLD  
VERSION)

**EX / CROSS :**

**T93518**



**Description:**

DIFF. GEAR AND PINION (13-40)

**Packaging Unit:** 1

**OEM No :**

TAS93518

**Model:**

**EX / CROSS :**



**T18285**



**Description:**

DIFF. GEAR AND PINION (15-29)

**Packaging Unit: 1**

**OEM No :**

346 350 6139

**Model:**

HD 7/016 DG-13  
HD 7/016 DSG-13  
HL 7/050 DCS-11,5  
HL 7/050 DCS-13  
HL 7/052 DS-13

**EX / CROSS :**

346 350 2839

346 350 2339

**T18023**



**Description:**

DIFF. GEAR AND PINION (15-29)

**Packaging Unit: 1**

**OEM No :**

346 350 6039

**Model:**

HL 7/015 D-13  
HL 7/015 DS-13  
HL 7/050 DCS-11,5  
HL 7/050 DCS-13  
HL 7/052 DS-13  
HL 7/07 D-10  
HL 7/07 DS-10

**EX / CROSS :**

346 350 5939

346 350 4339

346 350 2039

**T09189**



**Description:**

DIFF. GEAR AND PINION (17-29)

**Packaging Unit: 1**

**OEM No :**

355 350 3939

**Model:**

HD 7/19 DG-13  
HD 7/19 DSG-13  
HD 7/2 DSG-10

**EX / CROSS :**

355 350 3839

**T09007**



**Description:**

DIFF. GEAR AND PINION (17-29)

**Packaging Unit: 1**

**OEM No :**

357 350 0539

**Model:**

AL 7/1 D-7  
AL 7/1 DS-7  
AL 7/8 D-8  
HL 7/1 D-10  
HL 7/1 S-10  
HL 7/1-10  
HL 7/18 D-13  
HL 7/18 DS-13  
HL 7/24 DS-9  
HL 7/26 D-12,3  
HL 7/3 DS-10  
HO 7/8 DL-10

**EX / CROSS :**

355 350 4639

355 350 3239

305 350 0539

**T09526**



**Description:**

DIFF. GEAR AND PINION (17-29)

**Packaging Unit: 1**

**OEM No :**

357 350 0039

**Model:**

HL 7/013 D-16  
HL 7/015 D-13  
HL 7/015 DL-13  
HL 7/021 D-10  
HL 7/050 DCS-11,5  
HL 7/050 DCS-13  
HL 7/052 DS-13  
HL 7/07 D-10  
HL 7/07 DL-10  
HL 7/07 DS-10  
HO 7/02 DLM-10

**EX / CROSS :**

346 350 5739

346 350 5639

346 350 3939

346 350 1639



**T12312**

**Description:**

DIFF. GEAR AND PINION (17-29)

**Packaging Unit: 1**

**OEM No :**  
346 350 2639

**Model:**  
HD 7/014 DG-16  
HD 7/014 DGS-16  
HD 7/016 DG-13

**EX / CROSS :**  
346 350 2139



**T09009**

**Description:**

DIFF. GEAR AND PINION (18-27)

**Packaging Unit: 1**

**OEM No :**  
355 350 4739

**Model:**  
AL 7/1 D-7  
AL 7/1 DS-7  
AL 7/5 D-7  
AL 7/8 D-8  
HL 7/1 D-10  
HL 7/1 DL-10  
HL 7/1 L-10  
HL 7/1 S-10  
HL 7/1-10  
HL 7/18 D-13  
HL 7/18 D-13 TURKEY  
HL 7/18 DS-13  
HL 7/18 DS-13 TURKEY  
HL 7/24 DS-9  
HL 7/26 D-11,5  
HL 7/26 D-12,3  
HL 7/26 DL-12,3  
HL 7/3 D-10  
HL 7/3 DS-10  
HO 7/10 DL-11,5  
HO 7/8 DL-10  
HO 7/9 DL-10

**EX / CROSS :**



**T76831**

**Description:**

DIFF. GEAR AND PINION (18-27)

**Packaging Unit: 1**

**OEM No :**  
944 350 3839

**Model:**  
HP-0728-E  
HP-0928  
HP-1333  
HP-1333-E

**EX / CROSS :**  
944 350 3439



**T09006**

**Description:**

DIFF. GEAR AND PINION (18-27)

**Packaging Unit: 1**

**OEM No :**  
355 350 4039

**Model:**  
HD 7/19 DG-13  
HD 7/19 DGS-13  
HD 7/19 DGS-13 TURKEY  
HD 7/2 DG-10  
HD 7/2 DSG-10

**EX / CROSS :**  
355 350 3739



**T09187**

**Description:**

DIFF. GEAR AND PINION (18-27)

**Packaging Unit: 1**

**OEM No :**  
346 350 1739

**Model:**  
HL 7/013 D-16  
HL 7/013 DS-16 TURKEY  
HL 7/015 D-13  
HL 7/015 DL-13  
HL 7/015 DS-13  
HL 7/021 D-10  
HL 7/021 DL-10  
HL 7/021 DS-10  
HL 7/024 D-12,3  
HL 7/024 DL-12,3  
HL 7/050 DCS-11,5  
HL 7/050 DCS-13  
HL 7/052 DS-13  
HL 7/07 D-10  
HL 7/07 D-11,5  
HL 7/07 DL-10  
HL 7/07 DL-11,5  
HL 7/07 DS-10

**EX / CROSS :**  
346 350 4039

**T15373**



**Description:**

DIFF. GEAR AND PINION (18-27)

**Packaging Unit:** 1

**OEM No :**

346 350 4839

**Model:**

HD 7/014 DGS-16  
HD 7/014 DGS-16 TURKEY  
HD 7/016 DG-13  
HD 7/09 DG-10

**EX / CROSS :**

346 350 2739

346 350 2239

**T39261**



**Description:**

DIFF. GEAR AND PINION (18-27)

**Packaging Unit:** 1

**OEM No :**

942 350 2839

**Model:**

HD 7/055 DCGS-13  
HD 7/056 DGS-13  
HD 7/056 DGS-16

**EX / CROSS :**

**T76851**



**Description:**

DIFF. GEAR AND PINION (18-27)

**Packaging Unit:** 1

**OEM No :**

944 350 2739

**Model:**

HPD-1353

**EX / CROSS :**

**T20685**



**Description:**

DIFF. GEAR AND PINION (21-28)

**Packaging Unit:** 1

**OEM No :**

942 350 2739

**Model:**

HD 7/055 DCGS-13  
HD 7/056 DGS-13  
HD 7/056 DGS-16

**EX / CROSS :**

**T08963**



**Description:**

DIFF. GEAR AND PINION (21-28)

**Packaging Unit:** 1

**OEM No :**

346 350 1939

**Model:**

HL 7/015 D-13  
HL 7/015 D-13 TURKEY  
HL 7/015 DL-13  
HL 7/02 DL-10  
HL 7/021 D-10  
HL 7/021 DL-10  
HL 7/050 DCS-11,5  
HL 7/050 DCS-13  
HL 7/052 DS-13  
HL 7/07 D-10  
HL 7/07 D-11,5  
HL 7/07 DL-10

HO 7/01 DL-10

**EX / CROSS :**

346 350 4139





**T09077**



**Description:**

DIFF. GEAR AND PINION (21-28)

**Packaging Unit: 1**

**OEM No :**  
944 350 0739

**EX / CROSS :**  
944 350 0639  
355 350 4139  
355 350 3639

**Model:**  
HD 7/11 DG-9  
HD 7/19 DG-13  
HD 7/19 DGS-13  
HD 7/19 DGS-13 TURKEY  
HD 7/2 DG-10  
HD 7/2 DLG-10  
HD 7/2 DSG-10  
HD 7/5 DG-10

**T11045**



**Description:**

DIFF. GEAR AND PINION (21-28)

**Packaging Unit: 1**

**OEM No :**  
944 350 1839

**EX / CROSS :**  
355 350 5139  
355 350 3039  
305 350 0639

**Model:**  
AL 7/1 D-7  
HL 7/1 D-10  
HL 7/1 DL-10  
HL 7/1 L-10  
HL 7/1-10  
HL 7/10 D-9  
HL 7/18 D-13  
HL 7/18 DS-13 TURKEY  
HL 7/26 D-12,3  
HL 7/26 DL-12,3  
HL 7/3 D-10  
HL 7/3 DL-10  
HL 7/3 DS-10  
HL 7/4 D-10  
HO 7/8 DL-10  
HO 7/9 DL-10

**T14290**



**Description:**

DIFF. GEAR AND PINION (21-28)

**Packaging Unit: 1**

**OEM No :**  
942 350 0139

**EX / CROSS :**  
346 350 2939  
346 350 2439

**Model:**  
HD 7/016 DG-13

**T20618**



**Description:**

DIFF. GEAR AND PINION (21-28)

**Packaging Unit: 1**

**OEM No :**  
942 350 2239

**EX / CROSS :**  
942 350 1539

**Model:**  
HL 7/055 DCS-13

**T16624**



**Description:**

DIFF. GEAR AND PINION (24-26)

**Packaging Unit: 1**

**OEM No :**  
346 350 7639

**EX / CROSS :**  
346 350 4439

**Model:**  
HL 7/015 D-13  
HL 7/015 D-13 TURKEY  
HL 7/015 DL-13  
HL 7/024 D-12,3  
HL 7/024 DL-12,3  
HL 7/050 DCS-11,5  
HL 7/050 DCS-13  
HL 7/052 DS-13  
HL 7/07 D-10  
HL 7/07 D-11,5  
HL 7/07 DL-10  
HL 7/07 DL-11,5

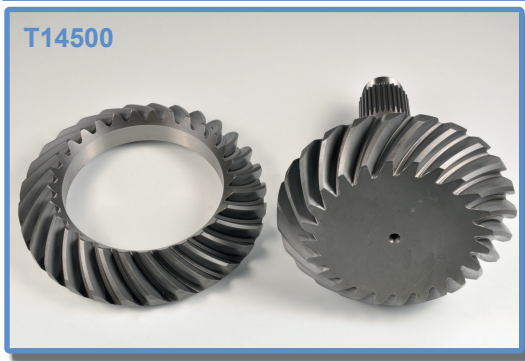

**Description:**

DIFF. GEAR AND PINION (24-29)

**Packaging Unit:** 1

**OEM No :**

346 350 8139

**Model:**

HD 7/014 DG-16  
HD 7/016 DG-13

**EX / CROSS :**

346 350 3639



**Description:**

DIFF. GEAR AND PINION (24-29)

**Packaging Unit:** 1

**OEM No :**

346 350 8039

**Model:**

HL 7/013 D-16  
HL 7/015 D-13  
HL 7/015 D-13 TURKEY  
HL 7/015 DL-13  
HL 7/021 D-10  
HL 7/024 D-12,3  
HL 7/024 DL-12,3  
HL 7/050 DCS-11,5  
HL 7/050 DCS-13  
HL 7/052 DCS-13  
HL 7/07 D-10  
HL 7/07 D-11,5

**EX / CROSS :**

346 350 3739

346 350 3539



**Description:**

DIFF. GEAR AND PINION (24-29)

**Packaging Unit:** 1

**OEM No :**

944 350 0439

**Model:**

AL 7/1 D-7  
AL 7/8 D-8  
HL 7/1 D-10  
HL 7/1 DL-10  
HL 7/1 L-10  
HL 7/1-10  
HL 7/18 D-13  
HL 7/26 D-12,3  
HL 7/26 DL-12,3  
HL 7/3 D-10  
HL 7/4 D-10  
HO 7/8 DL-10

**EX / CROSS :**

357 350 0639

355 350 5239

355 350 2939

305 350 0339



**Description:**

DIFF. GEAR AND PINION (24-29)

**Packaging Unit:** 1

**OEM No :**

355 350 4839

**Model:**

HD 7/19 DG-13  
HD 7/19 DG-13 TURKEY  
HD 7/19 DGS-13 TURKEY  
HD 7/2 DG-10  
HD 7/5 DG-10

**EX / CROSS :**



**Description:**

DIFF. GEAR AND PINION (24-29)

**Packaging Unit:** 1

**OEM No :**

942 350 2539

**Model:**

HD 7/055 DCS-13  
HD 7/056 DGS-13  
HD 7/056 DGS-16

**EX / CROSS :**

**T51363**



**Description:**

DIFF. GEAR AND PINION (24-29)

**Packaging Unit:** 1

**OEM No :**

942 350 3039

**Model:**

HL 7/055 DCS-13

**EX / CROSS :**

942 350 2139

942 350 1439

942 350 1339

**T17545**



**Description:**

DIFF. GEAR AND PINION (25-29)

**Packaging Unit:** 1

**OEM No :**

357 350 1639

**Model:**

AL 7/1 D-7  
HL 7/18 D-13  
HL 7/18 DS-13  
HL 7/26 DL-12,3  
HL 7/3 D-10  
HL 7/4 D-10  
HO 7/9 DL-10

**EX / CROSS :**

357 350 0739

357 350 0139

305 350 1639

305 350 0139

**T15652**



**Description:**

DIFF. GEAR AND PINION (25-29)

**Packaging Unit:** 1

**OEM No :**

355 350 4939

**Model:**

HD 7/19 DG-13  
HD 7/19 DGS-13  
HD 7/2 DG-10  
HD 7/5 DG-10

**EX / CROSS :**

**T75409**



**Description:**

DIFF. GEAR AND PINION (25-29)

**Packaging Unit:** 1

**OEM No :**

346 350 4639

**Model:**

HL 7/015 D-13  
HL 7/015 DL-13  
HL 7/021 D-10  
HL 7/024 D-12,3  
HL 7/050 DCS-11,5  
HL 7/050 DCS-13  
HL 7/052 DS-13  
HL 7/07 D-10  
HL 7/07 D-11,5  
HL 7/07 DL-10  
HL 7/07 DL-11,5

**EX / CROSS :**

346 350 3839

346 350 7839

**T64575**



**Description:**

DIFF. GEAR AND PINION (29-17)

**Packaging Unit:** 1

**OEM No :**

942 350 2439

**Model:**

HP-1342-E  
HP-1352  
HP-1652

**EX / CROSS :**





**T56709**



**Description:**

DIFF. GEAR AND PINION (7-41)

**Packaging Unit: 1**

**OEM No :**

385 350 4339

**Model:**

HD 4/03 D-10  
HD 4/03 D-10 BRAZIL  
HL 4/01 - 10  
HL 4/01 D-10  
HL 4/01 D-10 BRAZIL  
HL 4/01 DL-10  
HL 4/01-10  
HL 4/05 D-9,2  
HO 4/01 D-10 BRAZIL  
HO 4/01 D-10 TURKEY  
HO 4/01 DL-10 TURKEY

**EX / CROSS :**

652 350 0739

617 350 0139

384 350 0039

**T14458**



**Description:**

DIFF. GEAR AND PINION (7-43)

**Packaging Unit: 1**

**OEM No :**

385 350 3639

**Model:**

HL 4/01 D-10 BRAZIL  
HO 4/01 D-10 TURKEY

**EX / CROSS :**

**T08942**



**Description:**

DIFF. GEAR AND PINION (7-48)

**Packaging Unit: 1**

**OEM No :**

616 350 0139

**Model:**

HL 4/1-7,6  
HL 4/16-7,7  
HL 4/17 - 9,2  
HL 4/25 D-7,6 BRAZIL  
HL 4/25-7,6 BRAZIL  
HL 4/26 D-9,2 BRAZIL  
HL 4/29 D-9,2  
HL 4/4-8,8  
HL 4/7,6 BRAZIL  
HL 4/8-10  
HL 4/8-6,30

**EX / CROSS :**

383 350 0039

364 350 0239

341 350 0739

322 350 1839

**T19677**



**Description:**

DIFF. GEAR AND PINION (8-35)

**Packaging Unit: 1**

**OEM No :**

904 350 0039

**Model:**

HL O/01 C-3,2  
HL O/14 C-1,7  
HL O/15 C-2,2

**EX / CROSS :**

602 350 2539

**T63413**



**Description:**

DIFF. GEAR AND PINION (8-39)

**Packaging Unit: 1**

**OEM No :**

301 350 1339

**Model:**

HH 4/12 D-10 BRAZIL  
HH 4/19 D-10  
HL 4/16-7,7  
HL 4/23 - 7,7  
HL 4/23 L-7,7  
HL 4/25 D-7,6 BRAZIL  
HL 4/26 D-9,2 BRAZIL  
HL 4/27 D-10 BRAZIL  
HL 4/28 D-7,8  
HL 4/30 D-6,4  
HL 4/30 DS-6,4  
HL 4/35 D-7,8  
HL 4/60 D-10  
HL 4/60 D-10 BRAZIL  
HL 4/60 D-7,6  
HL 4/7,6 BRAZIL  
HO 4/10 DL-10  
HO 4/10 L-10  
HO 4/18 L-7,7

**EX / CROSS :**

302 350 1139

344 350 0239

383 350 0639

301 350 0539

**T08954**



**Description:**

DIFF. GEAR AND PINION (9-26)

**Packaging Unit:** 1

**OEM No :**

343 350 0039

**Model:**

HD 6/3 D-10  
HD 6/3 DG-10

**EX / CROSS :**

**T61191**



**Description:**

DIFF. GEAR AND PINION KIT (13-40)

**Packaging Unit:** 1

**OEM No :**

TAS61191

**Model:**

HL 6/1 DC(LC)-13 (OLD  
VERSION)  
HL 6/3 DC(L,S)-13 (OLD  
VERSION)

**EX / CROSS :**

9483531212+1710

**T93887**



**Description:**

DIFF. GEAR AND PINION W/CASE ASSEMBLY (11-48)

**Packaging Unit:** 1

**OEM No :**

906 350 2323

**Model:**

HL 0/01 C-3,2  
HL 0/14 C-1,7  
HL 0/15 C-2,2  
HL 0/2-2,2

**EX / CROSS :**

**T93886**



**Description:**

DIFF. GEAR AND PINION W/CASE ASSEMBLY (R.13,51)

**Packaging Unit:** 1

**OEM No :**

906 350 1523

**Model:**

HL 0/01 C-3,2  
HL 0/14 C-1,7  
HL 0/15 C-2,2  
HL 0/2-2,2

**EX / CROSS :**

**T41504**



**Description:**

DIFF. GEAR KIT

**Packaging Unit:** 1

**OEM No :**

TAS41504

**Model:**

HH 4/08 DL-11 (DETROIT  
AXLE)  
HL 4/63 DL-10 (DETROIT  
AXLE)

**EX / CROSS :**

**T76992**



**Description:**  
DIFF. GEAR KIT

**Packaging Unit:** 1

**OEM No :**  
970 350 0240

**Model:**  
HL 2/30 C-5,6  
HL 2/31 C(S)-4,4  
HL 2/43 DC-6,2  
HL 2/46 DC-8,5  
HL 2/47 DC-6,8

**EX / CROSS :**

**T12322**



**Description:**  
DIFF. GEAR KIT

**Packaging Unit:** 1

**OEM No :**  
395 350 0040

**Model:**  
AL 7/1 D-7  
AL 7/1 DS-7  
AL 7/5 D-7  
HD 7/11 DG-9  
HD 7/19 DG-13  
HD 7/19 DG-13 TURKEY  
HD 7/19 DGS-13  
HD 7/19 DGS-13 TURKEY  
HD 7/19 DSG-13  
HD 7/2 DG-10  
HD 7/2 DLG-10  
HD 7/2 DSG-10  
HD 7/5 DG-10  
HD 7/1 D-10  
HD 7/1 S-10  
HD 7/10 D-9  
HD 7/10 D-10  
HD 7/10 DL-10  
HD 7/1 L-10  
HD 7/1 S-10  
HL 7/1-10  
HL 7/10 D-9  
HL 7/18 D-13  
HL 7/18 D-13 TURKEY  
HL 7/18 DS-13  
HL 7/18 DS-13 TURKEY  
HL 7/24 DS-9

**EX / CROSS :**

**T09034**



**Description:**  
DIFF. GEAR KIT

**Packaging Unit:** 1

**OEM No :**  
393 586 0035

**Model:**  
AL 7/1 D-7  
AL 7/5 D-7  
HD 7/11 DG-9  
HD 7/19 DG-13  
HD 7/19 DGS-13  
HD 7/19 DSG-13  
HD 7/2 DG-10  
HD 7/2 DLG-10  
HD 7/2 DSG-10  
HD 7/5 DG-10  
HL 7/1 D-10  
HL 7/1 DL-10  
HL 7/1 L-10  
HL 7/1 S-10  
HL 7/10 D-9  
HL 7/10 D-13  
HL 7/18 DS-13  
HL 7/24 DS-9  
HL 7/3 D-10  
HL 7/3 DL-10  
HL 7/3 DS-10  
HL 7/4 D-10  
HO 7/8 DL-10

**EX / CROSS :**

**T15327**



**Description:**  
DIFF. GEAR KIT

**Packaging Unit:** 1

**OEM No :**  
(393 586 0035/M)

**Model:**  
HD 7/11 DG-9  
HD 7/19 DG-13  
HD 7/19 DGS-13  
HD 7/19 DSG-13  
HD 7/2 DG-10  
HD 7/2 DLG-10  
HD 7/2 DSG-10  
HD 7/5 DG-10

**EX / CROSS :**

**T09031**



**Description:**  
DIFF. GEAR KIT

**Packaging Unit:** 1

**OEM No :**  
387 350 0040

**Model:**  
HD 7/014 DG-16  
HD 7/014 DGS-16  
HD 7/016 DG-13  
HD 7/016 DSG-13  
HD 7/09 DG-10  
HL 7/013 D-16  
HL 7/013 DS-16 TURKEY  
HL 7/015 D-13  
HL 7/015 D-13 TURKEY  
HL 7/015 DL-13  
HL 7/015 DS-13  
HL 7/02 DL-10  
HL 7/021 D-10  
HL 7/021 DL-10  
HL 7/021 DS-10  
HL 7/024 D-12,3  
HL 7/024 DL-12,3  
HL 7/07 D-10  
HL 7/07 D-11,5  
HL 7/07 DL-10  
HL 7/07 DL-11,5  
HL 7/07 DS-10  
HO 7/01 DL-10  
HO 7/01 DLS-10

**EX / CROSS :**

387 586 0035  
696 350 0040  
386 350 0040



**T11713**



**Description:**  
DIFF. GEAR KIT

**Packaging Unit:** 1

**OEM No :**  
615 350 0040

**Model:**  
HD 4/02 DG-10  
HD 4/02 DG-10 BRAZIL  
HD 4/02 GD-10  
HD 4/03 D-10  
HD 4/03 D-10 BRAZIL  
HH 4/04 D-12  
HH 4/05 D-10 BRAZIL  
HH 4/07 DL-10 BRAZIL  
HL 4/01 - 10  
HL 4/01 D-10  
HL 4/01 D-10 BRAZIL  
HL 4/01 DL-10  
HL 4/01 DL-11,5  
HL 4/01 L-10  
HL 4/01-10  
HL 4/035 D-10,6  
HL 4/035 D-9,2  
HL 4/038 D-10  
HL 4/038 D-12  
HL 4/038 D-9,4  
HL 4/039 D-10  
HL 4/039 D-12  
HL 4/039 DL-12  
HL 4/05 D-9,2

**EX / CROSS :**

**T14457**



**Description:**  
DIFF. GEAR KIT

**Packaging Unit:** 1

**OEM No :**  
385 350 0040

**Model:**  
HD 4/02 DG-10  
HD 4/02 GD-10  
HD 4/03 D-10  
HD 4/03 D-10 BRAZIL  
HH 4/04 D-12  
HL 4/01 - 10  
HL 4/01 D-10  
HL 4/01 D-10 BRAZIL  
HL 4/01 DL-10  
HL 4/01 L-10  
HL 4/05 D-9,2  
HL 4/06 D-12  
HL 4/06 DL-12  
HL 4/07 D-9,4  
HL 4/08 D-10,6  
HL 4/09 D-9,2  
HO 4/01 D-10 BRAZIL  
HO 4/01 D-10 TURKEY  
HO 4/01 DL-10  
HO 4/01 DL-10 BRAZIL  
HO 4/01 DL-10 TURKEY

**EX / CROSS :**

**T75746**



**Description:**  
DIFF. GEAR KIT

**Packaging Unit:** 1

**OEM No :**  
695 350 0140

**Model:**  
HL 5/60 DZ-10

**EX / CROSS :**

**T76723**



**Description:**  
DIFF. GEAR KIT

**Packaging Unit:** 1

**OEM No :**  
668 350 0026

**Model:**  
HL O/6-3,9

**EX / CROSS :**  
463 280 0040  
460 586 0135

**T91098**



**Description:**  
DIFF. GEAR KIT (REINFORCED SPIDER)

**Packaging Unit:** 1

**OEM No :**  
948 350 0123R

**Model:**

**EX / CROSS :**  
948 350 0223



**T83439**



**Description:**

DIFF. GEAR KIT 944 350 0523/0623

**Packaging Unit:** 1

**OEM No :**

TAS83439

**Model:**

**EX / CROSS :**

**T61853**

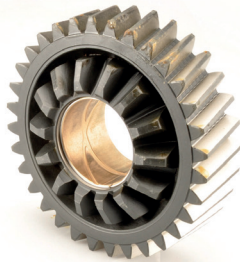

**Description:**

DIFF. HELICAL AND SIDE GEAR

**Packaging Unit:** 1

**OEM No :**

000 353 1785

**Model:**

HD 7/55 DCGS-13  
HD 7/56 DGS-13

**EX / CROSS :**

944 353 0185

**T61849**



**Description:**

DIFF. HELICAL AND SIDE GEAR

**Packaging Unit:** 1

**OEM No :**

000 353 1885

**Model:**

HD 7/55 DCGS-13  
HD 7/56 DGS-13

**EX / CROSS :**

944 353 0285

**T14930**



**Description:**

DIFF. HELICAL AND SIDE GEAR (10-28-16T.)

**Packaging Unit:** 1

**OEM No :**

355 350 1415

**Model:**

HD 7/11 DG-9  
HD 7/19 DG-13  
HD 7/19 DG-13 TURKEY  
HD 7/19 DGS-13  
HD 7/19 DGS-13 TURKEY  
HD 7/19 DSG-13  
HD 7/2 DG-10  
HD 7/2 DLG-10  
HD 7/2 DSG-10  
HD 7/5 DG-10

**EX / CROSS :**

**T15407**



**Description:**

DIFF. HELICAL AND SIDE GEAR (10-30-16T.)

**Packaging Unit:** 1

**OEM No :**

355 350 0624

**Model:**

HD 7/19 DG-13  
HD 7/2 DG-10  
HD 7/5 DG-10

**EX / CROSS :**

355 350 0324



**Description:** DIFF. HELICAL AND SIDE GEAR (10-30-16T.) **Packaging Unit:** 1

**OEM No :** 385 353 0085  
**EX / CROSS :**

**Model:**  
HD 4/02 DG-10  
HD 4/02 DG-10 BRAZIL  
HD 4/02 GD-10  
HD 4/021 GS-10 BRAZIL  
HD 4/21 DG-10  
HD 4/21 G-10  
HD 4/21 G-10 BRAZIL  
HD 4/22-10



**Description:** DIFF. HELICAL AND SIDE GEAR (10-30-18T.) **Packaging Unit:** 1

**OEM No :** 346 353 1785  
**EX / CROSS :** 346 353 1585  
346 353 0385  
346 353 0185  
346 350 1324

**Model:**  
HD 7/014 DG-16  
HD 7/014 DGS-16  
HD 7/014 DGS-16 TURKEY  
HD 7/016 DG-13  
HD 7/016 DSG-13  
HD 7/09 DG-10



**Description:** DIFF. HELICAL AND SIDE GEAR (12-37-14T.) W/BUSH **Packaging Unit:** 1

**OEM No :** 000 353 1685  
**EX / CROSS :**

**Model:**

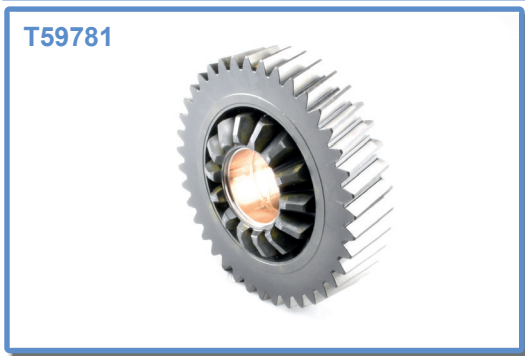

**Description:** DIFF. HELICAL AND SIDE GEAR (39T.) W/BUSH **Packaging Unit:** 1

**OEM No :** 000 353 1585  
**EX / CROSS :** 942 353 0185

**Model:**  
HD 7/055 DCGS-13  
HD 7/056 DGS-13  
HD 7/056 DGS-16



**Description:** DIFF. INPUT SHAFT (26-26T.) **Packaging Unit:** 1

**OEM No :** 343 353 0335  
**EX / CROSS :**

**Model:**  
HD 6/3 DG-10





**T14933**



**Description:**

DIFF. INPUT SHAFT (28-41-28T.)

**Packaging Unit: 1**

**OEM No :**  
355 353 0935

**EX / CROSS :**  
355 353 0235

**Model:**

HD 4/02 DG-10	HD 7/19 DSG-13
HD 4/02 GD-10	HD 7/2 DG-10
HD 4/021 GS-10 BRAZIL	HD 7/2 DLG-10
HD 4/21 DG-10	HD 7/2 DSG-10
HD 4/21 G-10	HD 7/5 DG-10
HD 4/21 G-10 BRAZIL	
HD 4/22-10	
HD 7/11 DG-9	
HD 7/19 DG-13	
HD 7/19 DG-13 TURKEY	
HD 7/19 DGS-13	
HD 7/19 DGS-13 TURKEY	

**T15298**



**Description:**

DIFF. INPUT SHAFT (34-42-31T.)

**Packaging Unit: 1**

**OEM No :**  
346 353 0735

**EX / CROSS :**  
346 353 0335

**Model:**

HD 7/014 DG-16
HD 7/014 DGS-16
HD 7/014 DGS-16 TURKEY
HD 7/016 DG-13
HD 7/016 DSG-13
HD 7/09 DG-10

**T18767**



**Description:**

DIFF. INPUT SHAFT (54T.)

**Packaging Unit: 1**

**OEM No :**  
942 353 0435

**EX / CROSS :**

**Model:**

HD 7/055 DCGS-13
HD 7/056 DGS-13
HD 7/056 DGS-16
HD 7/55 DCGS-13
HD 7/56 DGS-13

**T15296**



**Description:**

DIFF. LOADED CASE ASSEMBLY

**Packaging Unit: 1**

**OEM No :**  
343 350 1023

**EX / CROSS :**  
343 350 0723  
346 350 9523

**Model:**

HD 7/014 DG-16
HD 7/014 DGS-16
HD 7/014 DGS-16 TURKEY
HD 7/016 DG-13
HD 7/016 DSG-13
HD 7/09 DG-10

**T14928**



**Description:**

DIFF. LOADED CASE ASSEMBLY

**Packaging Unit: 1**

**OEM No :**  
387 350 9823

**EX / CROSS :**  
389 350 0423

**Model:**

HD 7/11 DG-9
HD 7/19 DG-13
HD 7/19 DGS-13
HD 7/19 DSG-13
HD 7/2 DG-10
HD 7/2 DLG-10
HD 7/2 DSG-10
HD 7/5 DG-10



T15413



**Description:**  
DIFF. LOADED CASE ASSEMBLY

**Packaging Unit:** 1

**OEM No :**  
658 350 0023

**Model:**  
HD 7/19 DG-13  
HD 7/2 DG-10  
HD 7/5 DG-10

**EX / CROSS :**

T15409



**Description:**  
DIFF. LOADED CASE ASSEMBLY

**Packaging Unit:** 1

**OEM No :**  
387 350 9423

**Model:**

**EX / CROSS :**

T45744



**Description:**  
DIFF. LONG PIN SPIDER

**Packaging Unit:** 1

**OEM No :**  
TAS45744

**Model:**

**EX / CROSS :**

T70984



**Description:**  
DIFF. LONG PIN SPIDER

**Packaging Unit:** 1

**OEM No :**  
948 353 0021

**Model:**  
HL 6/1 DC(L,S)-13  
(REINFORCED)  
HL 6/1 DC(LC)-13 (OLD  
VERSION)  
HL 6/1 DC(LC)-13  
(REINFORCED)  
HL 6/3 DC(L,S)-13 (OLD  
VERSION)

**EX / CROSS :**

T60247



**Description:**  
DIFF. PINION GEAR

**Packaging Unit:** 1

**OEM No :**  
946 353 0014

**Model:**  
HL 8/1 DCS-13  
HO 8/1 DCL(S)-13

**EX / CROSS :**











<p><b>T14938</b></p> 	<p><b>Description:</b> DIFF. PINION GEAR (10T.)</p> <p><b>OEM No :</b> 653 353 0014</p> <p><b>EX / CROSS :</b></p>	<p><b>Packaging Unit:</b> 4</p> <p><b>Model:</b> HD 4/02 DG-10 HD 4/02 GD-10 HD 4/021 GS-10 BRAZIL HD 4/21 DG-10 HD 4/21 G-10 HD 4/21 G-10 BRAZIL HD 4/22-10 HD 7/11 DG-9 HD 7/19 DG-13 HD 7/19 DG-13 TURKEY HD 7/19 DGS-13 HD 7/19 DGS-13 TURKEY</p> <p>HD 7/19 DSG-13 HD 7/2 DG-10 HD 7/2 DLG-10 HD 7/2 DSG-10 HD 7/5 DG-10</p>
<p><b>T09013</b></p> 	<p><b>Description:</b> DIFF. PINION GEAR (10T.)</p> <p><b>OEM No :</b> 355 353 0214</p> <p><b>EX / CROSS :</b> 355 353 0014</p>	<p><b>Packaging Unit:</b> 4</p> <p><b>Model:</b> HD 4/02 DG-10 HD 4/02 DG-10 BRAZIL HD 4/02 GD-10 HD 4/021 GS-10 BRAZIL HD 4/21 DG-10 HD 4/21 G-10 HD 4/21 G-10 BRAZIL HD 4/22-10 HD 7/11 DG-9 HD 7/19 DG-13 HD 7/19 DG-13 TURKEY HD 7/19 DGS-13</p> <p>HD 7/19 DGS-13 TURKEY HD 7/19 DSG-13 HD 7/2 DG-10 HD 7/2 DLG-10 HD 7/2 DSG-10 HD 7/5 DG-10</p>
<p><b>T12323</b></p> 	<p><b>Description:</b> DIFF. PINION GEAR (10T.)</p> <p><b>OEM No :</b> 395 353 0114</p> <p><b>EX / CROSS :</b></p>	<p><b>Packaging Unit:</b> 4</p> <p><b>Model:</b> AL 7/1 D-7 AL 7/1 DS-7 AL 7/5 D-7 HD 7/11 DG-9 HD 7/19 DG-13 HD 7/19 DG-13 TURKEY HD 7/19 DGS-13 HD 7/19 DGS-13 TURKEY HD 7/19 DSG-13 HD 7/2 DG-10 HD 7/2 DLG-10 HD 7/2 DSG-10</p> <p>HD 7/5 DG-10 HD 7/55 DCGS-13 HD 7/56 DGS-13 HL 7/1 D-10 HL 7/1 DL-10 HL 7/1 L-10 HL 7/1 S-10 HL 7/1-10 HL 7/10 D-9 HL 7/18 D-13 HL 7/18 DS-13 HL 7/24 DS-9 HL 7/3 D-10 HL 7/3 DL-10 HL 7/3 DS-10 HL 7/4 D-10 HL 7/18 DS-13</p>
<p><b>T09036</b></p> 	<p><b>Description:</b> DIFF. PINION GEAR (10T.)</p> <p><b>OEM No :</b> 494 335 0214</p> <p><b>EX / CROSS :</b></p>	<p><b>Packaging Unit:</b> 4</p> <p><b>Model:</b> AL 7/1 D-7 AL 7/5 D-7 HD 7/11 DG-9 HD 7/19 DG-13 HD 7/19 DGS-13 HD 7/19 DSG-13 HD 7/2 DG-10 HD 7/2 DLG-10 HD 7/2 DSG-10 HD 7/5 DG-10 HL 7/1 D-10 HL 7/1 DL-10</p> <p>HL 7/1 L-10 HL 7/1 S-10 HL 7/1-10 HL 7/10 D-9 HL 7/18 D-13 HL 7/18 DS-13 HL 7/24 DS-9 HL 7/3 D-10 HL 7/3 DL-10 HL 7/3 DS-10 HL 7/4 D-10 HO 7/8 DL-10</p>
<p><b>T01143</b></p> 	<p><b>Description:</b> DIFF. PINION GEAR (10T.)</p> <p><b>OEM No :</b> 302 353 0014</p> <p><b>EX / CROSS :</b></p>	<p><b>Packaging Unit:</b> 4</p> <p><b>Model:</b> AL 3/2-5 AL 3/4-4,3 AL 3/5-3,5 AL 3/5-5,5 AL 3/6 D-6 AL 3/6-6 AL 3/7 D-4,3 AL 3/7-4,3 AL 3/8 D-4,7 AL 3/8 DS-4,7 AL 3/9 D-6,8 HD 4/021 GS-10 BRAZIL</p> <p>HD 4/21 DG-10 HD 4/21 G-10 HD 4/21 G-10 BRAZIL HD 4/22 D-10 HD 4/22 DG-10 HD 4/22-10 HD 4/22-10 BRAZIL HH 4/12 - 10 HH 4/12 D-10 HH 4/12 D-10 BRAZIL HH 4/12-10 HH 4/19 D-10</p>



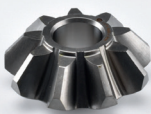

<p><b>T11992</b></p> 	<p><b>Description:</b> DIFF. PINION GEAR (10T.)</p> <p><b>OEM No :</b> 380 353 0014</p> <p><b>EX / CROSS :</b></p>	<p><b>Packaging Unit:</b> 1</p> <p><b>Model:</b> HL 2/11 D-5,8 HL 2/13 D-6,4 HL 2/14 D-6,9 HL 2/15-5,8 HL 2/4 L-6,4 HL 2/4-6,4 HL 2/7-7,7</p>
<p><b>T17848</b></p> 	<p><b>Description:</b> DIFF. PINION GEAR (11T.)</p> <p><b>OEM No :</b> 326 353 0414</p> <p><b>EX / CROSS :</b> 326 353 0314 326 253 0314</p>	<p><b>Packaging Unit:</b> 4</p> <p><b>Model:</b> AL 6/2 D-6 HD 6/3 D-10 HD 6/3 DG-10 HL 7/015 D-13 HL 7/07 D-10</p>
<p><b>T12824</b></p> 	<p><b>Description:</b> DIFF. PINION GEAR (11T.)</p> <p><b>OEM No :</b> 617 353 0114</p> <p><b>EX / CROSS :</b> 617 353 0014</p>	<p><b>Packaging Unit:</b> 4</p> <p><b>Model:</b> HD 4/02 DG-10 HD 4/02 GD-10 HD 4/03 D-10 HD 4/03 D-10 BRAZIL HH 4/04 D-12 HL 4/01 - 10 HL 4/01 D-10 HL 4/01 D-10 BRAZIL HL 4/01 DL-10 HL 4/01 L-10 HL 4/05 D-9,2 HL 4/06 D-12 HL 4/06 DL-12 HL 4/07 D-9,4 HL 4/08 D-10,6 HL 4/09 D-9,2 HO 4/01 D-10 BRAZIL HO 4/01 D-10 TURKEY HO 4/01 DL-10 HO 4/01 DL-10 BRAZIL HO 4/01 DL-10 TURKEY</p>
<p><b>T01164</b></p> 	<p><b>Description:</b> DIFF. PINION GEAR (11T.)</p> <p><b>OEM No :</b> 354 353 0014</p> <p><b>EX / CROSS :</b></p>	<p><b>Packaging Unit:</b> 4</p> <p><b>Model:</b> HL 5/02 D-10 BRAZIL HL 5/02-10 BRAZIL HL 5/1 S-10 HL 5/1 Z-10 HL 5/2 DZ-10 BRAZIL HL 5/2 S-6,5 HL 5/2 Z(S)-10 BRAZIL HL 5/2 Z-10 HL 5/2 ZL-10 HL 5/2 ZS-10 HL 5/2-10 HO 5/4 Z-10 HO 5/8 DL-10 HO 5/8 L-10</p>
<p><b>T75750</b></p> 	<p><b>Description:</b> DIFF. PINION GEAR (11T.)</p> <p><b>OEM No :</b> 615 353 0114</p> <p><b>EX / CROSS :</b></p>	<p><b>Packaging Unit:</b> 4</p> <p><b>Model:</b> HL 5/60 DZ-10</p>

<p><b>T11714</b></p> 	<p><b>Description:</b> DIFF. PINION GEAR (11T.)</p> <p><b>OEM No :</b> 615 353 0014</p> <p><b>EX / CROSS :</b></p>	<p><b>Packaging Unit:</b> 1</p> <p><b>Model:</b> HD 4/02 DG-10 HD 4/02 GD-10 HH 4/07 DL-10 BRAZIL HL 4/01 D-10 BRAZIL HO 4/01 D-10 BRAZIL HO 4/01 DL-10 BRAZIL</p>
<p><b>T15301</b></p> 	<p><b>Description:</b> DIFF. PINION GEAR (11T.)</p> <p><b>OEM No :</b> 659 353 0014</p> <p><b>EX / CROSS :</b></p>	<p><b>Packaging Unit:</b> 4</p> <p><b>Model:</b> HD 7/014 DG-16 HD 7/014 DGS-16 HD 7/014 DGS-16 TURKEY HD 7/016 DG-13 HD 7/016 DSG-13 HD 7/09 DG-10</p>
<p><b>T08985</b></p> 	<p><b>Description:</b> DIFF. PINION GEAR (11T.)</p> <p><b>OEM No :</b> 346 353 1014</p> <p><b>EX / CROSS :</b> 346 353 0614 346 353 1914</p>	<p><b>Packaging Unit:</b> 4</p> <p><b>Model:</b> HD 7/014 DG-16 HD 7/014 DGS-16 HD 7/016 DG-13 HD 7/016 DSG-13 HD 7/09 DG-10 HL 7/013 D-16 HL 7/013 DS-16 TURKEY HL 7/015 D-13 HL 7/015 D-13 TURKEY HL 7/015 DL-13 HL 7/015 DS-13 HL 7/02 DL-10 HL 7/021 D-10 HL 7/021 DL-10 HL 7/021 DS-10 HL 7/024 D-12,3 HL 7/024 DL-12,3 HL 7/07 D-10 HL 7/07 D-11,5 HL 7/07 DL-10 HL 7/07 DL-11,5 HL 7/07 DS-10 HO 7/01 DL-10 HO 7/01 DLS-10</p>
<p><b>T08981</b></p> 	<p><b>Description:</b> DIFF. PINION GEAR (11T.)</p> <p><b>OEM No :</b> 346 353 0514</p> <p><b>EX / CROSS :</b> 346 353 0114</p>	<p><b>Packaging Unit:</b> 4</p> <p><b>Model:</b> HD 7/014 DG-16 HD 7/014 DGS-16 HD 7/014 DGS-16 TURKEY HD 7/016 DG-13 HD 7/016 DSG-13 HD 7/09 DG-10</p>
<p><b>T46660</b></p> 	<p><b>Description:</b> DIFF. PINION GEAR (11T.)</p> <p><b>OEM No :</b> 385 353 0114</p> <p><b>EX / CROSS :</b></p>	<p><b>Packaging Unit:</b> 1</p> <p><b>Model:</b> HL 5/02 D-10 BRAZIL HL 5/02-10 BRAZIL HL 5/1 S-10 HL 5/1 Z-10 HL 5/2 DZ-10 BRAZIL HL 5/2 S-10 HL 5/2 S-6,5 HL 5/2 Z(S)-10 BRAZIL HL 5/2 Z-10 HL 5/2 ZL-10 HL 5/2 ZS-10 HL 5/2-10 HO 5/4 Z-10 HO 5/8 DL-10 HO 5/8 DZ-10 HO 5/8 L-10</p>

<p><b>T70988</b></p> 	<p><b>Description:</b> DIFF. PINION GEAR (9T.)</p> <p><b>OEM No :</b> 948 353 0014</p> <p><b>EX / CROSS :</b> TAS70988</p>	<p><b>Packaging Unit:</b> 1</p> <p><b>Model:</b> HL 6/1 DC(L,S)-13 (REINFORCED) HL 6/1 DC(LC)-13 (OLD VERSION) HL 6/1 DC(LC)-13 (REINFORCED) HL 6/3 DC(L,S)-13 (OLD VERSION)</p>
<p><b>T18709</b></p> 	<p><b>Description:</b> DIFF. PINION GEAR (9T.)</p> <p><b>OEM No :</b> (942 350 2223/PG)</p> <p><b>EX / CROSS :</b></p>	<p><b>Packaging Unit:</b> 4</p> <p><b>Model:</b></p>
<p><b>T11865</b></p> 	<p><b>Description:</b> DIFF. PINION GEAR BUSHING</p> <p><b>OEM No :</b> 346 350 9928</p> <p><b>EX / CROSS :</b></p>	<p><b>Packaging Unit:</b> 1</p> <p><b>Model:</b></p>
<p><b>T51922</b></p> 	<p><b>Description:</b> DIFF. REPAIR KIT</p> <p><b>OEM No :</b> 345 350 0054</p> <p><b>EX / CROSS :</b></p>	<p><b>Packaging Unit:</b> 5</p> <p><b>Model:</b> HL 5/60 DZ-10</p>
<p><b>T17862</b></p> 	<p><b>Description:</b> DIFF. REPAIR KIT</p> <p><b>OEM No :</b> 343 586 0135</p> <p><b>EX / CROSS :</b></p>	<p><b>Packaging Unit:</b> 1</p> <p><b>Model:</b> HD 6/3 D-10 HD 6/3 DG-10 HL 7/015 D-13 HL 7/07 D-10</p>



**T51400**



**Description:**  
DIFF. REPAIR KIT

**Packaging Unit:** 1

**OEM No :**  
000 350 0054

**Model:**  
HL 5/1 Z-10  
HL 5/2 Z-10  
HL 5/2 ZL-10  
HL 5/2 ZS-10  
HL 5/60 DZ-10  
HO 5/4 Z-10  
HO 5/8 DZ-10

**EX / CROSS :**

**T15329**



**Description:**  
DIFF. REPAIR KIT

**Packaging Unit:** 1

**OEM No :**  
658 350 0223

**Model:**  
HD 7/11 DG-9  
HD 7/19 DG-13  
HD 7/19 DGS-13  
HD 7/19 DSG-13  
HD 7/2 DG-10  
HD 7/2 DLG-10  
HD 7/2 DSG-10  
HD 7/5 DG-10

**EX / CROSS :**  
355 350 0040

**T15414**



**Description:**  
DIFF. REPAIR KIT

**Packaging Unit:** 1

**OEM No :**  
658 350 0323

**Model:**  
HD 7/19 DG-13  
HD 7/2 DG-10  
HD 7/5 DG-10

**EX / CROSS :**

**T15784**



**Description:**  
DIFF. REPAIR KIT

**Packaging Unit:** 1

**OEM No :**  
343 350 0923

**Model:**  
HD 7/014 DG-16  
HD 7/014 DGS-16  
HD 7/014 DGS-16 TURKEY  
HD 7/016 DG-13  
HD 7/016 DSG-13  
HD 7/09 DG-10

**EX / CROSS :**

**T18701**



**Description:**  
DIFF. REPAIR KIT

**Packaging Unit:** 1

**OEM No :**  
000 350 8123

**Model:**

**EX / CROSS :**



T63124



**Description:**  
DIFF. REPAIR KIT

**Packaging Unit:** 1

**OEM No :**  
TAS63124

**Model:**

**EX / CROSS :**

T76220



**Description:**  
DIFF. REPAIR KIT

**Packaging Unit:** 1

**OEM No :**  
TAS76220

**Model:**

**EX / CROSS :**

T74627



**Description:**  
DIFF. REPAIR KIT FOR 000 350 8023

**Packaging Unit:** 1

**OEM No :**  
TAS74627

**Model:**

**EX / CROSS :**

T64970



**Description:**  
DIFF. REPAIR KIT FOR 942 350 2123

**Packaging Unit:** 1

**OEM No :**  
TAS64970

**Model:**

**EX / CROSS :**

T61089







**Description:**  
DIFF. REPAIR KIT FOR 9823

**Packaging Unit:** 1

**OEM No :**  
TAS61089





**Model:**

**EX / CROSS :**

<p><b>T86080</b></p> 	<p><b>Description:</b> DIFF. REPAIR KIT FOR HL6</p> <p><b>OEM No :</b> TAS86080</p> <p><b>EX / CROSS :</b></p>	<p><b>Packaging Unit:</b> 1</p> <p><b>Model:</b> HL 6/1 DC(L,S)-13 (REINFORCED) HL 6/1 DC(LC)-13 (OLD VERSION) HL 6/1 DC(LC)-13 (REINFORCED) HL 6/3 DC(L,S)-13 (OLD VERSION)</p>
<p><b>T11227</b></p> 	<p><b>Description:</b> DIFF. RING GEAR (56T.)</p> <p><b>OEM No :</b> 355 354 1312</p> <p><b>EX / CROSS :</b> 346 354 0512</p>	<p><b>Packaging Unit:</b> 1</p> <p><b>Model:</b> HD 7/014 DG-16 HD 7/014 DGS-16 TURKEY HD 7/016 DG-13 HL 7/013 D-16 HL 7/013 DS-16 TURKEY HL 7/015 D-13 HL 7/021 D-10 HL 7/024 D-12,3 HL 7/024 DL-12,3 HO 7/01 DL-10 HO 7/8 DL-10 HO 7/9 DL-10</p>
<p><b>T63411</b></p> 	<p><b>Description:</b> DIFF. RING GEAR (56T.)</p> <p><b>OEM No :</b> 346 354 3712</p> <p><b>EX / CROSS :</b></p>	<p><b>Packaging Unit:</b> 1</p> <p><b>Model:</b> HD 7/014 DGS-16</p>
<p><b>T20183</b></p> 	<p><b>Description:</b> DIFF. RING GEAR (57T.)</p> <p><b>OEM No :</b> 346 354 1412</p> <p><b>EX / CROSS :</b></p>	<p><b>Packaging Unit:</b> 1</p> <p><b>Model:</b> HD 7/016 DG-13 HD 7/016 DSG-13 HD 7/09 DG-10 HL 7/013 D-16 HL 7/015 D-13 HL 7/015 D-13 TURKEY HL 7/015 DL-13 HL 7/015 DS-13 HL 7/02 DL-10 HL 7/021 D-10 HL 7/021 DL-10 HL 7/024 D-12,3 HL 7/024 DL-12,3 HL 7/07 D-10 HL 7/07 D-11,5 HL 7/07 DL-10 HL 7/07 DL-11,5 HL 7/07 DS-10 HO 7/01 DLS-10 HO 7/02 DLM-10 HO 7/10 DL-11,5 HO 7/9 DL-10</p>
<p><b>T08992</b></p> 	<p><b>Description:</b> DIFF. RING GEAR (57T.)</p> <p><b>OEM No :</b> 346 354 0412</p> <p><b>EX / CROSS :</b></p>	<p><b>Packaging Unit:</b> 1</p> <p><b>Model:</b> HL 7/015 D-13 HL 7/015 DL-13 HL 7/024 D-12,3 HL 7/024 DL-12,3 HL 7/07 D-11,5 HL 7/07 DL-11,5</p>



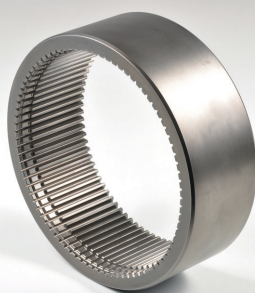
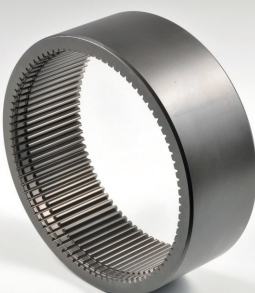

<p><b>T51401</b></p> 	<p><b>Description:</b> DIFF. RING GEAR (65T.)</p> <p><b>OEM No :</b> 346 354 3212</p> <p><b>EX / CROSS :</b></p>	<p><b>Packaging Unit:</b> 1</p> <p><b>Model:</b> HD 7/055 DCGS-13 HD 7/056 DGS-13 HL 7/015 D-13 HL 7/015 DL-13 HL 7/024 DL-12,3 HL 7/055 DCS-13 HL 7/07 D-10 HL 7/07 DL-10,5 HL 7/07 DL-11,5 HL 7/1 D-10 HL 7/26 D-12,3 HL 7/3 D-10</p> <p>HL 7/56 DS-13 HO 7/02 DLM-10 HO 7/9 DL-10</p>
<p><b>T39258</b></p> 	<p><b>Description:</b> DIFF. RING GEAR (75T.)</p> <p><b>OEM No :</b> 355 354 3012</p> <p><b>EX / CROSS :</b></p>	<p><b>Packaging Unit:</b> 1</p> <p><b>Model:</b> HD 7/014 DG-16 HD 7/014 DGS-16 TURKEY HD 7/016 DG-13 HD 7/055 DCGS-13 HD 7/056 DGS-13 HD 7/056 DGS-16 HD 7/11 DG-9 HD 7/19 DG-13 HD 7/19 DG-13 TURKEY HD 7/19 DGS-13 HD 7/19 DGS-13 TURKEY HD 7/19 DSG-13</p> <p>HD 7/2 DG-10 HD 7/2 DLG-10 HD 7/2 DSG-10 HD 7/5 DG-10 HL 7/013 D-16 HL 7/013 DS-16 TURKEY HL 7/015 D-13 HL 7/021 D-10 HL 7/021 DS-10 HL 7/024 D-12,3 HL 7/024 DL-12,3 HL 7/050 DCS-11,5</p>
<p><b>T20184</b></p> 	<p><b>Description:</b> DIFF. RING GEAR (85T.)</p> <p><b>OEM No :</b> 346 354 3012</p> <p><b>EX / CROSS :</b></p>	<p><b>Packaging Unit:</b> 1</p> <p><b>Model:</b> HD 7/016 DG-13 HD 7/016 DSG-13 HD 7/055 DCGS-13 HD 7/056 DGS-13 HD 7/056 DGS-16 HD 7/09 DG-10 HD 7/19 DG-13 HD 7/2 DG-10 HD 7/5 DG-10 HL 7/013 D-16 HL 7/015 D-13 HL 7/015 D-13 TURKEY</p> <p>HL 7/015 DL-13 HL 7/015 DS-13 HL 7/02 DL-10 HL 7/021 D-10 HL 7/021 DL-10 HL 7/024 D-12,3 HL 7/024 DL-12,3 HL 7/050 DCS-11,5 HL 7/050 DCS-13 HL 7/055 DCS-13 HL 7/07 D-10 HL 7/07 D-11,5</p>
<p><b>T19078</b></p> 	<p><b>Description:</b> DIFF. RING GEAR (89T.)</p> <p><b>OEM No :</b> 346 354 2612</p> <p><b>EX / CROSS :</b></p>	<p><b>Packaging Unit:</b> 1</p> <p><b>Model:</b> HD 7/016 DG-13 HD 7/016 DSG-13 HD 7/09 DG-10 HD 7/19 DG-13 HD 7/2 DG-10 HD 7/5 DG-10 HL 7/013 D-16 HL 7/015 D-13 HL 7/015 DL-13 HL 7/015 DS-13 HL 7/02 DL-10 HL 7/021 D-10</p> <p>HL 7/021 DL-10 HL 7/024 D-12,3 HL 7/024 DL-12,3 HL 7/07 D-10 HL 7/07 D-11,5 HL 7/07 DL-10 HL 7/07 DL-11,5 HL 7/07 DS-10 HL 7/1 DL-10 HL 7/18 D-13 HL 7/26 DL-12,3 HL 7/3 D-10</p>
<p><b>T91095</b></p> 	<p><b>Description:</b> DIFF. SHORT PIN SPIDER</p> <p><b>OEM No :</b> TAS91095</p> <p><b>EX / CROSS :</b></p>	<p><b>Packaging Unit:</b> 1</p> <p><b>Model:</b></p>



T45741



**Description:**  
DIFF. SHORT PIN SPIDER

**Packaging Unit:** 2

**OEM No :**  
TAS45741

**Model:**

**EX / CROSS :**  
(000 350 8023/SP)

T70986



**Description:**  
DIFF. SHORT PIN SPIDER

**Packaging Unit:** 2

**OEM No :**  
948 353 0121

**Model:**  
HL 6/1 DC(L,S)-13  
(REINFORCED)  
HL 6/1 DC(LC)-13 (OLD  
VERSION)  
HL 6/1 DC(LC)-13  
(REINFORCED)  
HL 6/3 DC(L,S)-13 (OLD  
VERSION)

**EX / CROSS :**

T91093



**Description:**  
DIFF. SHORT PIN SPIDER THREADED

**Packaging Unit:** 1

**OEM No :**  
TAS91093

**Model:**

**EX / CROSS :**

T73982



**Description:**  
DIFF. SHORT PIN SPIDER THREADED

**Packaging Unit:** 1

**OEM No :**  
TAS73982

**Model:**

**EX / CROSS :**

T60243



**Description:**  
DIFF. SIDE GEAR

**Packaging Unit:** 1

**OEM No :**  
946 353 0015





**Model:**  
HL 8/1 DCS-13  
HO 8/1 DCL(S)-13

**EX / CROSS :**

<p><b>T12317</b></p> 	<p><b>Description:</b> DIFF. SIDE GEAR (14T.-34SPL.)</p> <p><b>Packaging Unit:</b> 1</p> <p><b>OEM No :</b> 355 353 0615</p> <p><b>EX / CROSS :</b></p> <p><b>Model:</b> AL 7/1 D-7 AL 7/1 DS-7 AL 7/5 D-7 HD 7/11 DG-9 HD 7/19 DG-13 HD 7/19 DG-13 TURKEY HD 7/19 DGS-13 HD 7/19 DGS-13 TURKEY HD 7/19 DSG-13 HD 7/2 DG-10 HD 7/2 DLG-10 HD 7/2 DSG-10</p> <p>HD 7/5 DG-10 HD 7/55 DGS-13 HD 7/56 DGS-13 HL 7/1 D-10 HL 7/1 DL-10 HL 7/1 L-10 HL 7/1 S-10 HL 7/1 S-10 HL 7/10 D-9 HL 7/18 D-13 HL 7/18 D-13 TURKEY HL 7/18 DS-13</p>
<p><b>T70982</b></p> 	<p><b>Description:</b> DIFF. SIDE GEAR (14T.-40SPL.)</p> <p><b>Packaging Unit:</b> 1</p> <p><b>OEM No :</b> 948 353 0015</p> <p><b>EX / CROSS :</b> TAS70982</p> <p><b>Model:</b> HL 6/1 DC(L,S)-13 (REINFORCED) HL 6/1 DC(LC)-13 (OLD VERSION) HL 6/1 DC(LC)-13 (REINFORCED) HL 6/3 DC(L,S)-13 (OLD VERSION)</p>
<p><b>T09015</b></p> 	<p><b>Description:</b> DIFF. SIDE GEAR (16T.-22SPL.)</p> <p><b>Packaging Unit:</b> 1</p> <p><b>OEM No :</b> 355 353 0215</p> <p><b>EX / CROSS :</b> 355 350 0126</p> <p><b>Model:</b> HD 7/11 DG-9 HD 7/19 DG-13 HD 7/19 DG-13 TURKEY HD 7/19 DGS-13 HD 7/19 DGS-13 TURKEY HD 7/19 DSG-13 HD 7/2 DG-10 HD 7/2 DLG-10 HD 7/2 DSG-10 HD 7/5 DG-10</p>
<p><b>T19068</b></p> 	<p><b>Description:</b> DIFF. SIDE GEAR (16T.-22SPL.)</p> <p><b>Packaging Unit:</b> 1</p> <p><b>OEM No :</b> 385 353 0115</p> <p><b>EX / CROSS :</b></p> <p><b>Model:</b> HD 4/02 DG-10 HD 4/02 DG-10 BRAZIL HD 4/02 GD-10 HD 4/021 GS-10 BRAZIL HD 4/21 DG-10 HD 4/21 G-10 HD 4/21 G-10 BRAZIL HD 4/22-10</p>
<p><b>T14936</b></p> 	<p><b>Description:</b> DIFF. SIDE GEAR (16T.-22SPL.)</p> <p><b>Packaging Unit:</b> 1</p> <p><b>OEM No :</b> 355 353 1115</p> <p><b>EX / CROSS :</b></p> <p><b>Model:</b> HD 7/11 DG-9 HD 7/19 DG-13 HD 7/19 DGS-13 HD 7/19 DSG-13 HD 7/2 DG-10 HD 7/2 DLG-10 HD 7/2 DSG-10 HD 7/5 DG-10</p>



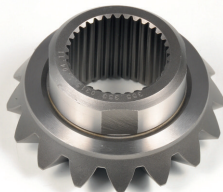

<p><b>T17850</b></p> 	<p><b>Description:</b> DIFF. SIDE GEAR (16T.-24SPL.)</p> <p><b>OEM No :</b> 335 353 0015</p> <p><b>EX / CROSS :</b></p>	<p><b>Packaging Unit:</b> 2</p> <p><b>Model:</b> HD 6/3 D-10 HD 6/3 DG-10 HL 7/015 D-13 HL 7/07 D-10</p>
<p><b>T75990</b></p> 	<p><b>Description:</b> DIFF. SIDE GEAR (16T.-25SPL.)</p> <p><b>OEM No :</b> 309 353 0115</p> <p><b>EX / CROSS :</b></p>	<p><b>Packaging Unit:</b> 1</p> <p><b>Model:</b></p>
<p><b>T09019</b></p> 	<p><b>Description:</b> DIFF. SIDE GEAR (16T.-34SPL.)</p> <p><b>OEM No :</b> 355 353 0315</p> <p><b>EX / CROSS :</b></p>	<p><b>Packaging Unit:</b> 1</p> <p><b>Model:</b> AL 7/1 D-7 AL 7/5 D-7 HD 7/11 DG-9 HD 7/19 DG-13 HD 7/19 DGS-13 HD 7/19 DSG-13 HD 7/2 DG-10 HD 7/2 DLG-10 HD 7/2 DSG-10 HD 7/5 DG-10 HL 7/1 D-10 HL 7/1 DL-10 HL 7/1 L-10 HL 7/1 S-10 HL 7/1-10 HL 7/10 D-9 HL 7/18 D-13 HL 7/18 DS-13 HL 7/24 DS-9 HL 7/3 D-10 HL 7/3 DL-10 HL 7/3 DS-10 HL 7/4 D-10 HO 7/8 DL-10</p>
<p><b>T71057</b></p> 	<p><b>Description:</b> DIFF. SIDE GEAR (16T.-38SPL.)</p> <p><b>OEM No :</b> 675 353 0215</p> <p><b>EX / CROSS :</b></p>	<p><b>Packaging Unit:</b> 1</p> <p><b>Model:</b> HL 2/30 C-5,6 HL 2/31 C(S)-4,4 HL 2/43 DC-6,2 HL 2/46 DC-8,5 HL 2/47 DC-6,8 HL 4/28 D-7,8 HL 4/30 D-6,4 HL 4/30 DS-6,4 HL 4/35 D-6,4 HL 4/35 D-7,8 HO 4/18 DL-7,7 HO 4/18 L-7,7</p>
<p><b>T08973</b></p> 	<p><b>Description:</b> DIFF. SIDE GEAR (16T.-40SPL.)</p> <p><b>OEM No :</b> 346 353 0815</p> <p><b>EX / CROSS :</b> 346 353 0315 TAS64974</p>	<p><b>Packaging Unit:</b> 1</p> <p><b>Model:</b> HD 7/014 DG-16 HD 7/014 DGS-16 HD 7/016 DG-13 HD 7/016 DSG-13 HD 7/09 DG-10 HL 7/013 D-16 HL 7/013 DS-16 TURKEY HL 7/015 D-13 HL 7/015 D-13 TURKEY HL 7/015 DL-13 HL 7/015 DS-13 HL 7/02 DL-10 HL 7/021 D-10 HL 7/021 DL-10 HL 7/021 DS-10 HL 7/024 D-12,3 HL 7/024 DL-12,3 HL 7/07 D-10 HL 7/07 D-11,5 HL 7/07 DL-10 HL 7/07 DL-11,5 HL 7/07 DS-10 HO 7/01 DL-10 HO 7/01 DLS-10</p>



<p><b>T15299</b></p> 	<p><b>Description:</b> DIFF. SIDE GEAR (18T.-26SPL.)</p> <p><b>Packaging Unit:</b> 1</p> <p><b>OEM No :</b> 346 353 1115</p> <p><b>EX / CROSS :</b> 346 353 0515</p> <p><b>Model:</b> HD 7/014 DG-16 HD 7/014 DGS-16 HD 7/014 DGS-16 TURKEY HD 7/016 DG-13 HD 7/016 DSG-13 HD 7/09 DG-10</p>
<p><b>T01166</b></p> 	<p><b>Description:</b> DIFF. SIDE GEAR (18T.-38SPL.)</p> <p><b>Packaging Unit:</b> 1</p> <p><b>OEM No :</b> 358 353 0015</p> <p><b>EX / CROSS :</b> 322 353 0615</p> <p><b>Model:</b> AL 3/2-5 AL 3/5-3,5 AL 3/5-5,5 HL 4/1-7,6 HL 4/16 L-7,7 HL 4/16-7,7 HL 4/23 - 7,7 HL 4/23 L-7,7 HL 4/25 D-7,6 BRAZIL HL 4/25-7,6 BRAZIL HL 4/28 D-7,8 HL 4/30 D-6,4 HL 4/30 DS-6,4 HL 4/35 D-6,4 HL 4/35 D-7,8 HL 4/60 D-7,6 HL 4/7,6 BRAZIL HO 4/18 DL-7,7 HO 4/18 L-7,7 HO 4/2-7,6 TURKEY</p>
<p><b>T05823</b></p> 	<p><b>Description:</b> DIFF. SIDE GEAR (18T.-38SPL.)</p> <p><b>Packaging Unit:</b> 1</p> <p><b>OEM No :</b> 322 353 0715</p> <p><b>EX / CROSS :</b> 322 353 0115 322 353 0015 321 353 0115</p>
<p><b>T01144</b></p> 	<p><b>Description:</b> DIFF. SIDE GEAR (18T.-40SPL.)</p> <p><b>Packaging Unit:</b> 1</p> <p><b>OEM No :</b> 302 353 0015</p> <p><b>EX / CROSS :</b></p> <p><b>Model:</b> HD 4/021 GS-10 BRAZIL HD 4/21 DG-10 HD 4/21 G-10 HD 4/21 G-10 BRAZIL HD 4/22 D-10 HD 4/22 DG-10 HD 4/22-10 HD 4/22-10 BRAZIL HH 4/12 - 10 HH 4/12 D-10 HH 4/12 D-10 BRAZIL HH 4/12-10 HH 4/19 D-10 HL 4/12 D-10 BRAZIL HL 4/14 - 8,8 HL 4/17 - 9,2 HL 4/17 D-9,2 HL 4/17 L-9,2 HL 4/17 S-9,2 HL 4/25 D-7,6 BRAZIL HL 4/26 D-9,2 BRAZIL HL 4/27 D-10 BRAZIL HL 4/29 D-9,2 HL 4/31 DS-7,0</p>
<p><b>T01165</b></p> 	<p><b>Description:</b> DIFF. SIDE GEAR (20T.-37SPL.)</p> <p><b>Packaging Unit:</b> 1</p> <p><b>OEM No :</b> 354 353 0015</p> <p><b>EX / CROSS :</b></p> <p><b>Model:</b> HL 5/02 D-10 BRAZIL HL 5/02-10 BRAZIL HL 5/1 S-10 HL 5/1 Z-10 HL 5/2 DZ-10 BRAZIL HL 5/2 S-6,5 HL 5/2 Z(S)-10 BRAZIL HL 5/2 Z-10 HL 5/2 ZL-10 HL 5/2 ZS-10 HL 5/2-10 HO 5/4 Z-10 HO 5/8 DL-10 HO 5/8 L-10</p>



**T57626**



**Description:**  
DIFF. SIDE GEAR (20T.-37SPL.)

**Packaging Unit:** 1

**OEM No :** 682 353 7015  
**Model:** HL 5/60 DZ-10

**EX / CROSS :**

**T51937**



**Description:**  
DIFF. SIDE GEAR (20T.-37SPL.)

**Packaging Unit:** 1

**OEM No :** 301 353 0115  
**Model:** HL 5/02 D-10 BRAZIL HO 5/4 Z-10  
HL 5/02-10 BRAZIL HO 5/8 DL-10  
HL 5/1 S-10 HO 5/8 DZ-10  
HL 5/1 Z-10 HO 5/8 L-10  
HL 5/2 DZ-10 BRAZIL  
HL 5/2 S-10  
HL 5/2 S-6,5  
HL 5/2 Z(S)-10 BRAZIL  
HL 5/2 Z-10  
HL 5/2 ZL-10  
HL 5/2 ZS-10  
HL 5/2-10

**EX / CROSS :**

**T11720**

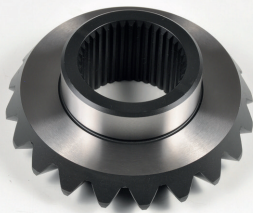

**Description:**  
DIFF. SIDE GEAR (20T.-38SPL.)

**Packaging Unit:** 1

**OEM No :** 615 353 0115  
**Model:**

**EX / CROSS :**

**T18713**



**Description:**  
DIFF. SIDE GEAR W/BUSH (14T.-26SPL.)

**Packaging Unit:** 1

**OEM No :** (942 350 2223/SG)  
**Model:**

**EX / CROSS :**

**T14935**



**Description:**  
DIFF. SLIDING SLEEVE (10T.-41SPL.)

**Packaging Unit:** 1

**OEM No :** 355 353 1236  
**Model:** HD 4/02 DG-10 HD 7/19 DGS-13 TURKEY  
HD 4/02 DG-10 BRAZIL HD 7/19 DSG-13  
HD 4/02 GD-10 HD 7/2 DG-10  
HD 4/021 GS-10 BRAZIL HD 7/2 DLG-10  
HD 4/21 DG-10 HD 7/2 DSG-10  
HD 4/21 G-10 HD 7/5 DG-10  
HD 4/21 G-10 BRAZIL  
HD 4/22-10  
HD 7/11 DG-9  
HD 7/19 DG-13  
HD 7/19 DG-13 TURKEY  
HD 7/19 DGS-13

**EX / CROSS :**

355 353 1036

355 353 0736



<p><b>T08987</b></p> 	<p><b>Description:</b> DIFF. SLIDING SLEEVE (10T.-42SPL.)</p> <p><b>OEM No :</b> 346 353 1136</p> <p><b>EX / CROSS :</b> 346 353 0836 346 353 0736</p>	<p><b>Packaging Unit:</b> 1</p> <p><b>Model:</b> HD 7/014 DG-16 HD 7/014 DGS-16 HD 7/014 DGS-16 TURKEY HD 7/016 DG-13 HD 7/016 DSG-13 HD 7/09 DG-10</p>
<p><b>T09021</b></p> 	<p><b>Description:</b> DIFF. SPIDER</p> <p><b>OEM No :</b> 355 353 0620</p> <p><b>EX / CROSS :</b></p>	<p><b>Packaging Unit:</b> 1</p> <p><b>Model:</b> AL 7/1 D-7 AL 7/5 D-7 HD 7/11 DG-9 HD 7/19 DG-13 HD 7/19 DGS-13 HD 7/19 DSG-13 HD 7/2 DG-10 HD 7/2 DLG-10 HD 7/2 DSG-10 HD 7/5 DG-10 HL 7/1 D-10 HL 7/1 DL-10 HL 7/1 L-10 HL 7/1 S-10 HL 7/1-10 HL 7/10 D-9 HL 7/18 D-13 HL 7/18 DS-13 HL 7/24 DS-9 HL 7/3 D-10 HL 7/3 DL-10 HL 7/3 DS-10 HL 7/4 D-10 HO 7/8 DL-10</p>
<p><b>T11716</b></p> 	<p><b>Description:</b> DIFF. SPIDER</p> <p><b>OEM No :</b> 615 353 0120</p> <p><b>EX / CROSS :</b></p>	<p><b>Packaging Unit:</b> 1</p> <p><b>Model:</b> HD 4/02 DG-10 HD 4/02 DG-10 BRAZIL HD 4/02 GD-10 HD 4/03 D-10 HD 4/03 D-10 BRAZIL HH 4/04 D-12 HH 4/05 D-10 BRAZIL HH 4/07 DL-10 BRAZIL HL 4/01 - 10 HL 4/01 D-10 HL 4/01 D-10 BRAZIL HL 4/01 DL-10 HL 4/01 DL-11,5 HL 4/01 L-10 HL 4/01-10 HL 4/035 D-10,6 HL 4/035 D-9,2 HL 4/038 D-10 HL 4/038 D-12 HL 4/038 D-9,4 HL 4/039 D-10 HL 4/039 D-12 HL 4/039 DL-12 HL 4/05 D-9,2</p>
<p><b>T17844</b></p> 	<p><b>Description:</b> DIFF. SPIDER</p> <p><b>OEM No :</b> 304 353 0020</p> <p><b>EX / CROSS :</b></p>	<p><b>Packaging Unit:</b> 1</p> <p><b>Model:</b> AL 6/2 D-6 HD 6/3 D-10 HD 6/3 DG-10 HL 7/015 D-13 HL 7/07 D-10</p>
<p><b>T18715</b></p> 	<p><b>Description:</b> DIFF. SPIDER</p> <p><b>OEM No :</b> (942 350 2223/SP)</p> <p><b>EX / CROSS :</b></p>	<p><b>Packaging Unit:</b> 1</p> <p><b>Model:</b></p>



**T08979**



**Description:**  
DIFF. SPIDER

**Packaging Unit:** 1

**OEM No :**  
346 353 0420

**Model:**

**EX / CROSS :**

HD 7/014 DG-16	HL 7/02 DL-10
HD 7/014 DGS-16	HL 7/021 D-10
HD 7/014 DGS-16 TURKEY	HL 7/021 DL-10
HD 7/016 DG-13	HL 7/021 DS-10
HD 7/016 DSG-13	HL 7/024 D-12,3
HD 7/09 DG-10	HL 7/024 DL-12,3
HL 7/013 D-16	HL 7/050 DCS-11,5
HL 7/013 DS-16 TURKEY	HL 7/050 DCS-13
HL 7/015 D-13	HL 7/052 DS-13
HL 7/015 D-13 TURKEY	HL 7/07 D-10
HL 7/015 DL-13	HL 7/07 D-11,5
HL 7/015 DS-13	HL 7/07 DL-10

**T12325**



**Description:**  
DIFF. SPIDER

**Packaging Unit:** 1

**OEM No :**  
395 353 0320

**Model:**

**EX / CROSS :**

AL 7/1 D-7	HD 7/5 DG-10
AL 7/1 DS-7	HL 7/1 D-10
AL 7/5 D-7	HL 7/1 DL-10
HD 7/11 DG-9	HL 7/1 L-10
HD 7/19 DG-13	HL 7/1 S-10
HD 7/19 DG-13 TURKEY	HL 7/1-10
HD 7/19 DGS-13	HL 7/10 D-9
HD 7/19 DGS-13 TURKEY	HL 7/18 D-13
HD 7/19 DSG-13	HL 7/18 D-13 TURKEY
HD 7/2 DG-10	HL 7/18 DS-13
HD 7/2 DLG-10	HL 7/18 DS-13 TURKEY
HD 7/2 DSG-10	HL 7/24 DS-9

**T14940**



**Description:**  
DIFF. SPIDER

**Packaging Unit:** 1

**OEM No :**  
653 353 0020

**Model:**

**EX / CROSS :**

HD 4/02 DG-10	HD 7/19 DSG-13
HD 4/02 GD-10	HD 7/2 DG-10
HD 4/021 GS-10 BRAZIL	HD 7/2 DLG-10
HD 4/21 DG-10	HD 7/2 DSG-10
HD 4/21 G-10	HD 7/5 DG-10
HD 4/21 G-10 BRAZIL	
HD 4/22-10	
HD 7/11 DG-9	
HD 7/19 DG-13	
HD 7/19 DG-13 TURKEY	
HD 7/19 DGS-13	
HD 7/19 DGS-13 TURKEY	

**T01170**



**Description:**  
DIFF. SPIDER

**Packaging Unit:** 1

**OEM No :**  
383 353 0120

**Model:**

**EX / CROSS :**

345 353 7120  
345 353 7020  
322 353 0120

AL 3/2-5	HD 4/21 DG-10
AL 3/4-4,3	HD 4/21 G-10
AL 3/5-3,5	HD 4/21 G-10 BRAZIL
AL 3/5-5,5	HD 4/22 D-10
AL 3/6 D-6	HD 4/22 DG-10
AL 3/6-6	HD 4/22-10
AL 3/7 D-4,3	HD 4/22-10 BRAZIL
AL 3/7-4,3	HH 4/12 - 10
AL 3/8 D-4,7	HH 4/12 D-10
AL 3/8 DS-4,7	HH 4/12 D-10 BRAZIL
AL 3/9 D-6,8	HH 4/12-10
HD 4/021 GS-10 BRAZIL	HH 4/19 D-10

**T13668**



**Description:**  
DIFF. SPIDER

**Packaging Unit:** 1

**OEM No :**  
617 353 0120





**Model:**

**EX / CROSS :**

617 353 0020

HD 4/02 DG-10	HL 4/06 DL-12
HD 4/02 GD-10	HL 4/07 D-9,4
HD 4/03 D-10	HL 4/08 D-10,6
HD 4/03 D-10 BRAZIL	HL 4/09 D-9,2
HH 4/04 D-12	HO 4/01 D-10 BRAZIL
HL 4/01 - 10	HO 4/01 D-10 TURKEY
HL 4/01 D-10	HO 4/01 DL-10
HL 4/01 D-10 BRAZIL	HO 4/01 DL-10 BRAZIL
HL 4/01 DL-10	HO 4/01 DL-10 TURKEY
HL 4/01 L-10	
HL 4/05 D-9,2	
HL 4/06 D-12	

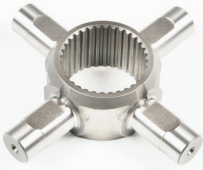

<p><b>T09144</b></p> 	<p><b>Description:</b> DIFF. SPIDER</p> <p><b>OEM No :</b> 308 353 0020</p> <p><b>EX / CROSS :</b></p>	<p><b>Packaging Unit:</b> 1</p> <p><b>Model:</b> HD 7/11 DG-9 HD 7/19 DG-13 HD 7/19 DGS-13 HD 7/19 DSG-13 HD 7/2 DG-10 HD 7/2 DLG-10 HD 7/2 DSG-10 HD 7/5 DG-10</p>
<p><b>T57627</b></p> 	<p><b>Description:</b> DIFF. SPIDER</p> <p><b>OEM No :</b> 682 353 7020</p> <p><b>EX / CROSS :</b></p>	<p><b>Packaging Unit:</b> 1</p> <p><b>Model:</b> HL 5/60 DZ-10</p>
<p><b>T01167</b></p> 	<p><b>Description:</b> DIFF. SPIDER</p> <p><b>OEM No :</b> 360 353 0020</p> <p><b>EX / CROSS :</b></p>	<p><b>Packaging Unit:</b> 1</p> <p><b>Model:</b></p>
<p><b>T15302</b></p> 	<p><b>Description:</b> DIFF. SPIDER</p> <p><b>OEM No :</b> 659 353 0020</p> <p><b>EX / CROSS :</b></p>	<p><b>Packaging Unit:</b> 1</p> <p><b>Model:</b> HD 7/014 DG-16 HD 7/014 DGS-16 HD 7/014 DGS-16 TURKEY HD 7/016 DG-13 HD 7/016 DSG-13 HD 7/09 DG-10</p>
<p><b>T46657</b></p> 	<p><b>Description:</b> DIFF. SPIDER</p> <p><b>OEM No :</b> 301 353 0020</p> <p><b>EX / CROSS :</b></p>	<p><b>Packaging Unit:</b> 1</p> <p><b>Model:</b> HL 5/02 D-10 BRAZIL HL 5/02-10 BRAZIL HL 5/1 S-10 HL 5/1 Z-10 HL 5/2 DZ-10 BRAZIL HL 5/2 S-10 HL 5/2 S-6,5 HL 5/2 Z(S)-10 BRAZIL HL 5/2 Z-10 HL 5/2 ZL-10 HL 5/2 ZS-10 HL 5/2-10 HO 5/4 Z-10 HO 5/8 DL-10 HO 5/8 DZ-10 HO 5/8 L-10</p>





**T49097**



**Description:**

DIFF. SPIDER AND PINIONS KIT FOR HD

**Packaging Unit:** 1

**OEM No :**

TAS49097

**Model:**

**EX / CROSS :**

**T45740**



**Description:**

DIFF. SPIDER ASSEMBLY FOR 000 350 8023

**Packaging Unit:** 1

**OEM No :**

TAS45740

**Model:**

**EX / CROSS :**

**T09004**

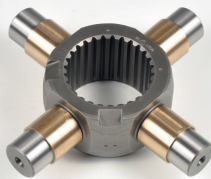

**Description:**

DIFF. SPIDER W/BUSH

**Packaging Unit:** 1

**OEM No :**

355 350 0128

**Model:**

HD 4/02 DG-10	HD 7/19 DGS-13 TURKEY
HD 4/02 DG-10 BRAZIL	HD 7/19 DSG-13
HD 4/02 GD-10	HD 7/2 DG-10
HD 4/021 GS-10 BRAZIL	HD 7/2 DLG-10
HD 4/21 DG-10	HD 7/2 DSG-10
HD 4/21 G-10	HD 7/5 DG-10
HD 4/21 G-10 BRAZIL	
HD 4/22-10	
HD 7/11 DG-9	
HD 7/19 DG-13	
HD 7/19 DG-13 TURKEY	
HD 7/19 DGS-13	

**EX / CROSS :**

**T08957**



**Description:**

DIFF. SPIDER W/BUSH

**Packaging Unit:** 1

**OEM No :**

346 350 0128

**Model:**

HD 7/014 DG-16
HD 7/014 DGS-16
HD 7/014 DGS-16 TURKEY
HD 7/016 DG-13
HD 7/016 DSG-13
HD 7/09 DG-10

**EX / CROSS :**

**T93880**



**Description:**

DIFF. WASHER KIT HL6

**Packaging Unit:** 1

**OEM No :**

TAS93880

**Model:**

**EX / CROSS :**



T20189



**Description:**

DIFF. WASHERS AND BUSHING KIT FOR AL-HD-HL

**Packaging Unit:** 1

**OEM No :**  
355 353 9850

**Model:**

**EX / CROSS :**  
(MB-355)

T49098



**Description:**

DIFF. WASHERS AND BUSHING KIT FOR HD

**Packaging Unit:** 1

**OEM No :**  
TAS49098

**Model:**

**EX / CROSS :**

T60893



**Description:**

DIFF. WASHERS AND BUSHING KIT FOR HD

**Packaging Unit:** 1

**OEM No :**  
TAS60893

**Model:**

**EX / CROSS :**

T20182



**Description:**

DIFF. WASHERS AND BUSHING KIT FOR HD-HL

**Packaging Unit:** 1

**OEM No :**  
346 353 9850

**Model:**

**EX / CROSS :**  
(MB-346)

T91058



**Description:**

DIFF. WASHERS AND BUSHING KIT FOR HD-HL

**Packaging Unit:** 1

**OEM No :**  
TAS20182/S

**Model:**

**EX / CROSS :**



T93831



**Description:**  
DISC BRAKE PADS

**Packaging Unit:** 1

**OEM No :**  
005 420 0720

**Model:**

**EX / CROSS :**  
005 420 4320  
005 420 4920  
005 420 5120  
005 420 8120

T93840



**Description:**  
DISC BRAKE PADS

**Packaging Unit:** 1

**OEM No :**  
000 423 0230

**Model:**

**EX / CROSS :**  
003 420 5120  
004 420 4420  
005 420 7920  
005 420 9320

T53260



**Description:**  
DISC KIT

**Packaging Unit:** 1

**OEM No :**  
960 262 0191

**Model:**  
G330-12/11,64-0,78

**EX / CROSS :**  
960 262 0091  
947 260 4036

T94033



**Description:**  
DISC KIT

**Packaging Unit:** 1

**OEM No :**  
TAS94033

**Model:**

**EX / CROSS :**

T81944



**Description:**  
DISK INNER (56T.)

**Packaging Unit:** 7

**OEM No :**  
945 264 0008

**Model:**  
G100-12  
G210-16/14,2-0,83  
G210-16/14,2-0,83 ESP  
G211-16/17,03-1,0  
G230-16/14,2-0,83  
G231-16/17,03-1,0  
G240-16/11,72-0,69  
G240-16/11,72-0,69 ESP  
G260-16/9,75-0,57

**EX / CROSS :**



**T81950**

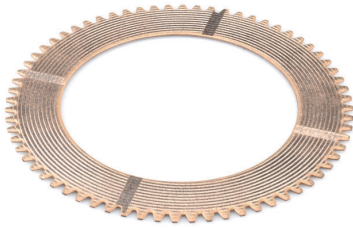

**Description:**  
DISK OUTER (68T.)

**Packaging Unit:** 8

**OEM No :**  
945 264 0009

**Model:**  
G100-12  
G210-16/14,2-0,83  
G210-16/14,2-0,83 ESP  
G211-16/17,03-1,0  
G230-16/14,2-0,83  
G231-16/17,03-1,0  
G240-16/11,72-0,69  
G240-16/11,72-0,69 ESP  
G260-16/9,75-0,57

**EX / CROSS :**

**T83054**



**Description:**  
DRIVE SHAFT

**Packaging Unit:** 1

**OEM No :**  
658 357 0901

**Model:**  
HD 7/014 DGS-16  
HD 7/014 DGS-16 TURKEY  
HD 7/016 DG-13  
HL 7/013 DS-16 TURKEY  
HL 7/015 D-13  
HL 7/015 DL-13  
HL 7/015 DS-13  
HL 7/021 DS-10  
HL 7/050 DCS-11,5  
HL 7/050 DCS-13  
HL 7/055 DCS-13  
HL 7/07 D-10  
HL 7/07 DL-10  
HL 7/07 DL-11,5  
HL 7/07 DS-10  
HO 7/01 DLS-10  
HO 7/02 DLM-10

**EX / CROSS :**

**T20616**



**Description:**  
DRIVE SHAFT

**Packaging Unit:** 1

**OEM No :**  
385 353 0835

**Model:**  
HD 7/19 DGS-13 TURKEY  
HD 7/5 DG-10

**EX / CROSS :**  
355 353 0835

**T20034**



**Description:**  
DRIVE SHAFT

**Packaging Unit:** 1

**OEM No :**  
658 357 0701

**Model:**  
HD 7/014 DGS-16 TURKEY  
HD 7/016 DG-13  
HL 7/015 D-13  
HL 7/015 DL-13  
HL 7/015 DS-13  
HL 7/07 D-10  
HL 7/07 DL-10  
HL 7/07 DL-11,5  
HL 7/07 DS-10  
HO 7/01 DLS-10  
HO 7/02 DLM-10

**EX / CROSS :**  
346 357 1801  
346 357 0601

**T14907**



**Description:**  
DRIVE SHAFT (22SPL.)

**Packaging Unit:** 1

**OEM No :**  
355 353 0135

**Model:**  
HD 7/11 DG-9  
HD 7/19 DG-13  
HD 7/19 DG-13 TURKEY  
HD 7/19 DGS-13  
HD 7/19 DGS-13 TURKEY  
HD 7/19 DSG-13  
HD 7/2 DG-10  
HD 7/2 DLG-10  
HD 7/2 DSG-10  
HD 7/5 DG-10

**EX / CROSS :**

**T19215**



**Description:**  
DRIVE SHAFT (22SPL.)

**Packaging Unit:** 1

**OEM No :**  
355 353 0735

**Model:**  
HD 7/19 DG-13  
HD 7/19 DGS-13  
HD 7/19 DGS-13 TURKEY  
HD 7/2 DG-10  
HD 7/5 DG-10

**EX / CROSS :**

**T15509**



**Description:**  
DRIVE SHAFT (24-24-24T.)

**Packaging Unit:** 1

**OEM No :**  
335 357 0102

**Model:**  
HD 6/3 D-10  
HD 6/3 DG-10  
HL 7/015 D-13  
HL 7/07 D-10

**EX / CROSS :**

335 357 0101  
335 357 0002  
335 357 0001

**T19079**



**Description:**  
DRIVE SHAFT (26SPL.)

**Packaging Unit:** 1

**OEM No :**  
942 353 0135

**Model:**  
HD 7/014 DGS-16  
HD 7/016 DG-13

**EX / CROSS :**

346 353 0635

**T14502**



**Description:**  
DRIVE SHAFT (26SPL.)

**Packaging Unit:** 1

**OEM No :**  
346 353 0435

**Model:**  
HD 7/014 DG-16  
HD 7/014 DGS-16  
HD 7/014 DGS-16 TURKEY  
HD 7/016 DG-13  
HD 7/016 DSG-13  
HD 7/09 DG-10

**EX / CROSS :**

**T60230**



**Description:**  
DRIVE SHAFT (26T.)





**Packaging Unit:** 1

**OEM No :**  
942 353 0235

**Model:**  
HD 7/055 DCGS-13  
HD 7/056 DGS-13  
HD 7/056 DGS-16





**EX / CROSS :**



<p><b>T72773</b></p> 	<p><b>Description:</b> ELASTIC PIN (Ø6X14)</p> <p><b>OEM No :</b> 308748 006003</p> <p><b>EX / CROSS :</b></p>	<p><b>Packaging Unit:</b> 2</p> <p><b>Model:</b></p>
<p><b>T39706</b></p> 	<p><b>Description:</b> ELASTIC PIN (ø6X50)</p> <p><b>OEM No :</b> 001 991 7860</p> <p><b>EX / CROSS :</b> 001481 006011</p>	<p><b>Packaging Unit:</b> 1</p> <p><b>Model:</b></p> <p>G125-16/14,0 G131-9 G135-16/11,9 G141-9 G155-16/11,9 G155-16/14,0 G155-9/15,9 G180-16/11,9 G180-16/14,0 G200-16/11,9 G210-16/14,2-0,83 G221-9/10,19-1,00</p> <p>G231-16/17,03-1,0 G240-16/11,72-0,69 G260-16/9,75-0,57 G330-12/11,64-0,78 GO210-8/11,8</p>
<p><b>T39045</b></p> 	<p><b>Description:</b> ELASTIC RING</p> <p><b>OEM No :</b> 389 262 0973</p> <p><b>EX / CROSS :</b></p>	<p><b>Packaging Unit:</b> 1</p> <p><b>Model:</b></p> <p>G125-16/14,0 G135-16/11,9 G155-16/11,9 G155-16/14,0 G180-16/11,9 G180-16/14,0 G200-16/11,9 G210-16/14,2-0,83 G211-16/17,03-1,0 G230-16/14,2-0,83 G231-16/17,03-1,0 G240-16/11,72-0,69</p> <p>G260-16/9,75-0,57</p>
<p><b>T49964</b></p> 	<p><b>Description:</b> ELASTIC RING</p> <p><b>OEM No :</b> 007993 050200</p> <p><b>EX / CROSS :</b></p>	<p><b>Packaging Unit:</b> 1</p> <p><b>Model:</b></p> <p>G210-16/14,2-0,83 G240-16/11,72-0,69</p>
<p><b>T69142</b></p> 	<p><b>Description:</b> ELASTIC RING (T.1,80)</p> <p><b>OEM No :</b> 976 262 1794</p> <p><b>EX / CROSS :</b></p>	<p><b>Packaging Unit:</b> 1</p> <p><b>Model:</b></p> <p>G71-6 G85-6/6,70-0,83 G90-6 GO110-6/6,1-0,747</p>





<p><b>T49302</b></p> 	<p><b>Description:</b> ELASTIC RING (T.1,88)</p> <p><b>OEM No :</b> 970 262 0194</p> <p><b>EX / CROSS :</b></p>	<p><b>Packaging Unit:</b> 4</p> <p><b>Model:</b> G56-6 G60-6/9,20-1,00 G70-6 G71-6 G85-6/6,70-0,83 G90-6 GO110-6/6,1-0,747</p>
<p><b>T69141</b></p> 	<p><b>Description:</b> ELASTIC RING (T.1,90)</p> <p><b>OEM No :</b> 976 262 1594</p> <p><b>EX / CROSS :</b></p>	<p><b>Packaging Unit:</b> 1</p> <p><b>Model:</b> G71-6 G85-6/6,70-0,83 G90-6 GO110-6/6,1-0,747 UG100-8/9,57-0,7 GPA UNIMOG</p>
<p><b>T49301</b></p> 	<p><b>Description:</b> ELASTIC RING (T.1,92)</p> <p><b>OEM No :</b> 970 262 0294</p> <p><b>EX / CROSS :</b></p>	<p><b>Packaging Unit:</b> 1</p> <p><b>Model:</b> G56-6 G60-6/9,20-1,00 G70-6 G71-6 G85-6/6,70-0,83 G90-6 GO110-6/6,1-0,747</p>
<p><b>T49300</b></p> 	<p><b>Description:</b> ELASTIC RING (T.1,96)</p> <p><b>OEM No :</b> 970 262 0394</p> <p><b>EX / CROSS :</b></p>	<p><b>Packaging Unit:</b> 1</p> <p><b>Model:</b> G56-6 G60-6/9,20-1,00 G70-6 G71-6 G85-6/6,70-0,83 G90-6 GO110-6/6,1-0,747</p>
<p><b>T49299</b></p> 	<p><b>Description:</b> ELASTIC RING (T.2,00)</p> <p><b>OEM No :</b> 970 262 0494</p> <p><b>EX / CROSS :</b></p>	<p><b>Packaging Unit:</b> 4</p> <p><b>Model:</b> G56-6 G60-6/9,20-1,00 G70-6 G71-6 G85-6/6,70-0,83 G90-6 GO110-6/6,1-0,747</p>

<p><b>T49295</b></p> 	<p><b>Description:</b> ELASTIC RING (T.2,02)</p> <p><b>OEM No :</b> 976 262 1294</p> <p><b>EX / CROSS :</b> 976 262 0894</p>	<p><b>Packaging Unit:</b> 4</p> <p><b>Model:</b> G71-6 G85-6/6,70-0,83 G90-6 GO110-6/6,1-0,747 UG100-8/9,57-0,7 GPA UNIMOG</p>
<p><b>T49294</b></p> 	<p><b>Description:</b> ELASTIC RING (T.2,06)</p> <p><b>OEM No :</b> 976 262 1194</p> <p><b>EX / CROSS :</b></p>	<p><b>Packaging Unit:</b> 1</p> <p><b>Model:</b> G71-6 G90-6 GO110-6/6,1-0,747 UG100-8/9,57-0,7 GPA UNIMOG</p>
<p><b>T49293</b></p> 	<p><b>Description:</b> ELASTIC RING (T.2,10)</p> <p><b>OEM No :</b> 976 262 1094</p> <p><b>EX / CROSS :</b> 976 262 0694</p>	<p><b>Packaging Unit:</b> 4</p> <p><b>Model:</b> G71-6 G85-6/6,70-0,83 G90-6 GO110-6/6,1-0,747 UG100-8/9,57-0,7 GPA UNIMOG</p>
<p><b>T08999</b></p> 	<p><b>Description:</b> ENGINE CRANKSHAFT VIBRATION DAMPER</p> <p><b>OEM No :</b> 355 030 2703</p> <p><b>EX / CROSS :</b> 355 030 2203</p>	<p><b>Packaging Unit:</b> 1</p> <p><b>Model:</b></p>
<p><b>T64066</b></p> 	<p><b>Description:</b> FAN ADAPTOR AND HUB KIT</p> <p><b>OEM No :</b> TAS64066</p> <p><b>EX / CROSS :</b></p>	<p><b>Packaging Unit:</b> 1</p> <p><b>Model:</b></p>



T09001



**Description:**  
FAN BLADE ASSEMBLY

**Packaging Unit:** 1

**OEM No :**  
475 200 0024

**Model:**

**EX / CROSS :**  
355 200 1124  
345 200 7724

T64064

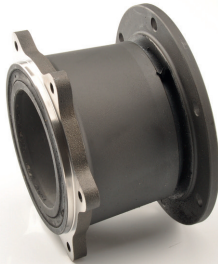

**Description:**  
FAN HUB (110 MM)

**Packaging Unit:** 1

**OEM No :**  
404 200 0226

**Model:**

**EX / CROSS :**

T64052



**Description:**  
FAN HUB (80 MM)

**Packaging Unit:** 1

**OEM No :**  
403 200 0926

**Model:**

**EX / CROSS :**  
402 200 0126

T41629



**Description:**  
FILTER

**Packaging Unit:**

**OEM No :**  
1530 0027 510

**Model:**

**EX / CROSS :**  
000 435 0413

T16986



**Description:**  
FLANGE

**Packaging Unit:** 1

**OEM No :**  
343 352 0016

**Model:**  
HD 6/3 DG-10

**EX / CROSS :**





<p><b>T75822</b></p> 	<p><b>Description:</b> FLANGE</p> <p><b>OEM No :</b> TAS75819</p> <p><b>EX / CROSS :</b></p>	<p><b>Packaging Unit:</b> 1</p> <p><b>Model:</b></p>
<p><b>T12469</b></p> 	<p><b>Description:</b> FLANGE OUTPUT (Ø 120-16SPL.)</p> <p><b>OEM No :</b> 322 262 0045</p> <p><b>EX / CROSS :</b></p>	<p><b>Packaging Unit:</b> 1</p> <p><b>Model:</b> G3/36-5/8,98 G3/40-5/7,5 G3/50-5/8,5 G3/60-5/6,1 G3/60-5/6,1 Brazil G3/60-5/7,5 G3/61-5/6,1</p>
<p><b>T15505</b></p> 	<p><b>Description:</b> FLANGE OUTPUT (Ø 150-26SPL.)</p> <p><b>OEM No :</b> 315 353 0045</p> <p><b>EX / CROSS :</b></p>	<p><b>Packaging Unit:</b> 1</p> <p><b>Model:</b> HD 6/3 D-10 HD 6/3 DG-10</p>
<p><b>T15510</b></p> 	<p><b>Description:</b> FLANGE OUTPUT (Ø 150-26SPL.)</p> <p><b>OEM No :</b> 343 282 0545</p> <p><b>EX / CROSS :</b></p>	<p><b>Packaging Unit:</b> 1</p> <p><b>Model:</b> W600-3W</p>
<p><b>T20944</b></p> 	<p><b>Description:</b> FLANGE OUTPUT (Ø 150)</p> <p><b>OEM No :</b> 976 262 0345</p> <p><b>EX / CROSS :</b> 976 262 0145 976 262 0045 947 262 2745 947 262 0345</p>	<p><b>Packaging Unit:</b> 1</p> <p><b>Model:</b> G100-12 G131-9 G141-9 G281-12 Klauen GO190-6/8,2-1,0 GO230-6/6,5-0,8 GO4/160-6/8,2</p>



**T44025**



**Description:**  
FLANGE OUTPUT (Ø 150)

**Packaging Unit:** 1

**OEM No :**  
385 262 0645

**Model:**  
G3/65-8/9,29  
G3/65-9/13,36  
G3/90-8/9,29

**EX / CROSS :**  
385 262 0145

**T15533**



**Description:**  
FLANGE OUTPUT (Ø 165-28SPL.)

**Packaging Unit:** 1

**OEM No :**  
355 350 0645

**Model:**  
HD 4/02 DG-10  
HD 4/02 GD-10  
HD 4/21 DG-10  
HD 4/21 G-10  
HD 7/11 DG-9  
HD 7/19 DG-13  
HD 7/2 DLG-10  
HD 7/5 DG-10

**EX / CROSS :**

**T15651**



**Description:**  
FLANGE OUTPUT (Ø 165-31SPL.)

**Packaging Unit:** 1

**OEM No :**  
346 350 0645

**Model:**  
HL 7/015 D-13  
HL 7/015 DL-13  
HL 7/07 D-10

**EX / CROSS :**

**T14766**



**Description:**  
FLANGE OUTPUT (Ø 165-31SPL.)

**Packaging Unit:** 1

**OEM No :**  
346 350 0445

**Model:**  
HL 7/013 D-16  
HL 7/015 D-13  
HL 7/015 DL-13  
HL 7/015 DS-13  
HL 7/02 DL-10  
HL 7/021 D-10  
HL 7/021 DL-10  
HL 7/07 D-10  
HL 7/07 DL-10  
HO 7/01 DL-10  
HO 7/01 DLS-10

**EX / CROSS :**

**T14903**



**Description:**  
FLANGE OUTPUT (Ø 180-28SPL.)

**Packaging Unit:** 1

**OEM No :**  
355 350 0745

**Model:**  
HD 4/02 DG-10  
HD 4/02 DG-10 BRAZIL  
HD 4/02 GD-10  
HD 7/11 DG-9  
HD 7/19 DG-13  
HD 7/19 DG-13 TURKEY  
HD 7/19 DGS-13  
HD 7/19 DGS-13 TURKEY  
HD 7/19 DSG-13  
HD 7/2 DG-10  
HD 7/2 DLG-10  
HD 7/2 DSG-10

HD 7/5 DG-10

**EX / CROSS :**

<p><b>T14494</b></p> 	<p><b>Description:</b> FLANGE OUTPUT (Ø 180-30SPL.)</p> <p><b>Packaging Unit:</b> 1</p> <p><b>OEM No :</b> 389 262 0445</p> <p><b>Model:</b> G125-16/14,0 G135-16/11,9 G155-16/11,9 G155-16/14,0 G155-9/15,9 G180-16/11,9 G180-16/14,0 G200-16/11,9 G210-16/14,2-0,83 G211-16/17,03-1,0 G230-16/14,2-0,83 G241-16 Klauen</p> <p><b>EX / CROSS :</b></p> <p>G280-16 Klauen GO210-8/11,8</p>
<p><b>T11848</b></p> 	<p><b>Description:</b> FLANGE OUTPUT (Ø 180-31SPL.)</p> <p><b>Packaging Unit:</b> 1</p> <p><b>OEM No :</b> 346 350 0545</p> <p><b>Model:</b> HD 7/014 DGS-16 HD 7/014 DGS-16 TURKEY HD 7/016 DG-13 HD 7/016 DSG-13 HD 7/09 DG-10 HL 7/013 D-16 HL 7/013 DS-16 TURKEY HL 7/015 D-13 HL 7/015 D-13 TURKEY HL 7/015 DL-13 HL 7/015 DS-13 HL 7/021 DL-10</p> <p><b>EX / CROSS :</b></p> <p>HL 7/07 D-10 HL 7/07 DL-10 HL 7/07 DL-11,5 HL 7/07 DS-10</p>
<p><b>T15154</b></p> 	<p><b>Description:</b> FLANGE OUTPUT (Ø 180-31SPL.)</p> <p><b>Packaging Unit:</b> 1</p> <p><b>OEM No :</b> 942 350 0045</p> <p><b>Model:</b></p> <p><b>EX / CROSS :</b> 346 350 1445</p>
<p><b>T63242</b></p> 	<p><b>Description:</b> FLANGE OUTPUT (Ø 180)</p> <p><b>Packaging Unit:</b> 1</p> <p><b>OEM No :</b> 389 262 0545</p> <p><b>Model:</b> G211-16/17,03-1,0 G221-9/10,19-1,00 G230-16/14,2-0,83 G231-16/17,03-1,0 G240-16/11,72-0,69 G260-16/9,75-0,57</p> <p><b>EX / CROSS :</b> 945 262 0145</p>
<p><b>T82129</b></p> 	<p><b>Description:</b> FLANGE OUTPUT (Ø 180)</p> <p><b>Packaging Unit:</b> 1</p> <p><b>OEM No :</b> 946 350 0145</p> <p><b>Model:</b> HL 6/1 DC(L,S)-13 (REINFORCED) HL 6/1 DC(LC)-13 (OLD VERSION) HL 6/1 DC(LC)-13 (REINFORCED) HL 6/3 DC(L,S)-13 (OLD VERSION) HL 8/1 DCS-13</p> <p><b>EX / CROSS :</b></p>

**T38800**



**Description:**  
FLANGE OUTPUT (Ø 180)

**Packaging Unit:** 1

**OEM No :**  
945 262 0045

**Model:**  
G181-9  
G210-16/14,2-0,83  
G211-16/17,03-1,0  
G221-9/10,19-1,00  
G230-16/14,2-0,83  
G231-16/17,03-1,0  
G240-16/11,72-0,69  
G241-16 Klauen  
G260-16/9,75-0,57  
G280-16 Klauen  
G281-12 Klauen  
G330-12/11,64-0,78

**EX / CROSS :**

**T44023**



**Description:**  
FLANGE OUTPUT (Ø 200)

**Packaging Unit:** 1

**OEM No :**  
930 262 0145

**Model:**  
G230-16/14,2-0,83  
G231-16/17,03-1,0  
G240-16/11,72-0,69  
G241-16 Klauen  
G280-16 Klauen  
G281-12 Klauen

**EX / CROSS :**

**T49974**



**Description:**  
FLANGE OUTPUT (Ø 200)

**Packaging Unit:** 1

**OEM No :**  
942 353 1245

**Model:**  
HD 7/055 DCGS-13  
HD 7/056 DGS-13  
HD 7/056 DGS-16

**EX / CROSS :**  
942 353 0845  
942 353 0745

**T49978**



**Description:**  
FLANGE OUTPUT (Ø 200)

**Packaging Unit:** 1

**OEM No :**  
389 262 0945

**Model:**  
G211-16/17,03-1,0  
G221-9/10,19-1,00  
G230-16/14,2-0,83  
G240-16/11,72-0,69  
G260-16/9,75-0,57

**EX / CROSS :**  
945 262 0345

**T50088**



**Description:**  
FLANGE OUTPUT (Ø 200)





**Packaging Unit:** 1

**OEM No :**  
389 262 0645

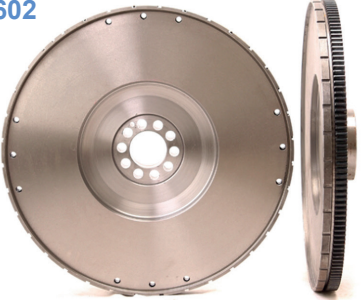

**Model:**  
G200-16/11,9  
G211-16/17,03-1,0  
G221-9/10,19-1,00  
G230-16/14,2-0,83  
G240-16/11,72-0,69  
G260-16/9,75-0,57  
G280-16 Klauen  
G330-12/11,64-0,78

**EX / CROSS :**



<p><b>T19725</b></p> 	<p><b>Description:</b> FLANGE OUTPUT (Ø180-31SPL.)</p> <p><b>OEM No :</b> 942 353 1045</p> <p><b>EX / CROSS :</b> 942 353 0645 000 350 1145</p>	<p><b>Packaging Unit:</b> 1</p> <p><b>Model:</b> HD 7/055 DCGS-13 HD 7/056 DGS-13 HD 7/056 DGS-16 HD 7/55 DCGS-13 HD 7/56 DGS-13</p>
<p><b>T47602</b></p> 	<p><b>Description:</b> FLYWHEEL ASSEMBLY (Ø 430X160T.)</p> <p><b>OEM No :</b> 542 030 0205</p> <p><b>EX / CROSS :</b> 541 030 0105</p>	<p><b>Packaging Unit:</b> 1</p> <p><b>Model:</b></p>
<p><b>T45600</b></p> 	<p><b>Description:</b> FOLLOWER RING (27-32T.)</p> <p><b>OEM No :</b> 970 262 0835</p> <p><b>EX / CROSS :</b> 975 262 0135 694 262 0035 693 262 0135</p>	<p><b>Packaging Unit:</b> 1</p> <p><b>Model:</b> G60-6/9,20-1,00 G85-6/6,70-0,83 GO110-6/6,1-0,747</p>
<p><b>T50069</b></p> 	<p><b>Description:</b> FORK</p> <p><b>OEM No :</b> 947 265 2701</p> <p><b>EX / CROSS :</b> 947 265 2601 947 265 0801 389 265 0901 389 265 0201</p>	<p><b>Packaging Unit:</b> 1</p> <p><b>Model:</b> G125-16/14,0 G131-9 G135-16/11,9 G155-16/11,9 G155-16/14,0 G155-9/15,9 G180-16/11,9 G180-16/14,0 G181-9 G200-16/11,9 G210-16/14,2-0,83 G211-16/17,03-1,0 G221-9/10,19-1,00 G230-16/14,2-0,83 G231-16/17,03-1,0 G240-16/11,72-0,69 G260-16/9,75-0,57 GO210-8/11,8</p>
<p><b>T69160</b></p> 	<p><b>Description:</b> FORK REVERSE</p> <p><b>OEM No :</b> 970 260 5031</p> <p><b>EX / CROSS :</b></p>	<p><b>Packaging Unit:</b> 1</p> <p><b>Model:</b> G60-6/9,20-1,00 G85-6/6,70-0,83</p>

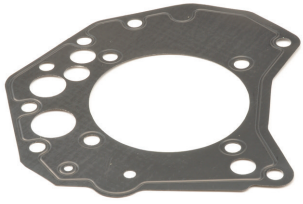
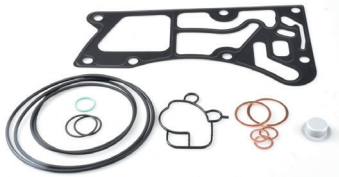

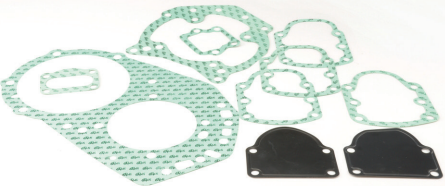
<p><b>T49905</b></p> 	<p><b>Description:</b> GASKET</p> <p><b>Packaging Unit:</b> 5</p> <p><b>OEM No :</b> 945 261 0580</p> <p><b>Model:</b> G240-16/11,72-0,69</p> <p><b>EX / CROSS :</b> 945 261 0080</p>
<p><b>T66847</b></p> 	<p><b>Description:</b> GASKET</p> <p><b>Packaging Unit:</b></p> <p><b>OEM No :</b> TAS66847</p> <p><b>Model:</b></p> <p><b>EX / CROSS :</b></p>
<p><b>T64583</b></p> 	<p><b>Description:</b> GASKET</p> <p><b>Packaging Unit:</b> 1</p> <p><b>OEM No :</b> 942 353 0180</p> <p><b>Model:</b> HP-0728-E HP-0928 HP-1333 HP-1333-E HP-1342-E HP-1352 HP-1652 HPD-1353 HPD-1372-E HPD-1382 HPD-1682 HY-0718 HY-0925 HY-1130-B HY-1130_1133 HY-1350 HY-1350-B HYD-1370</p> <p><b>EX / CROSS :</b></p>
<p><b>T61827</b></p> 	<p><b>Description:</b> GASKET AND OIL SEAL KIT G240-16</p> <p><b>Packaging Unit:</b> 1</p> <p><b>OEM No :</b> TAS61827</p> <p><b>Model:</b> G240-16/11,72-0,69</p> <p><b>EX / CROSS :</b></p>
<p><b>T63506</b></p> 	<p><b>Description:</b> GASKET KIT G240-16</p> <p><b>Packaging Unit:</b> 1</p> <p><b>OEM No :</b> TAS63506</p> <p><b>Model:</b> G240-16/11,72-0,69</p> <p><b>EX / CROSS :</b></p>



T66794



**Description:**  
GEAR

**Packaging Unit:**

**OEM No :**  
976 262 0914

**Model:**  
G71-6  
G90-6

**EX / CROSS :**  
970 262 1514  
967 262 0114

T66531



**Description:**  
GEAR CNTRSHFT (27-34T.)

**Packaging Unit:** 1

**OEM No :**  
947 263 1713

**Model:**  
G241-16 Klauen

**EX / CROSS :**  
947 263 1613  
945 263 5613  
945 263 5513  
945 263 5413

T94582



**Description:**  
GEAR CNTRSHFT (29-31T.)

**Packaging Unit:** 1

**OEM No :**  
960 263 0010

**Model:**  
G280-16 Klauen

**EX / CROSS :**

T66533



**Description:**  
GEAR CNTRSHFT (29-34T.)

**Packaging Unit:** 1

**OEM No :**  
945 263 7313

**Model:**  
G241-16 Klauen  
G280-16 Klauen

**EX / CROSS :**  
945 263 5813  
945 263 5713

T57275



**Description:**  
GEAR CNTRSHFT (30-30T.)

**Packaging Unit:** 1

**OEM No :**  
930 263 1910

**Model:**  
G330-12/11,64-0,78

**EX / CROSS :**



**T66536**



**Description:**  
GEAR CNTRSHFT (33-36T.)

**Packaging Unit:** 1

**OEM No :**  
947 263 2910

**Model:**  
G211-12 Klauen

**EX / CROSS :**  
947 263 0910

**T65199**

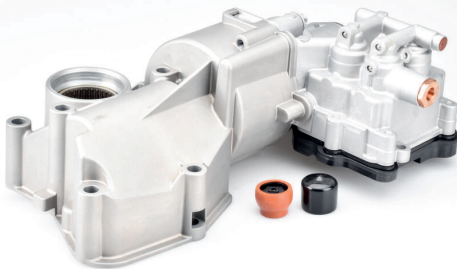

**Description:**  
GEAR CONTROL CYLINDER

**Packaging Unit:**

**OEM No :**  
930 260 0263

**Model:**  
G211-12 Klauen  
G281-12 Klauen

**EX / CROSS :**

**T09011**



**Description:**  
GROOVED NUT

**Packaging Unit:** 1

**OEM No :**  
355 353 0026

**Model:**  
HD 4/02 DG-10  
HD 4/02 DG-10 BRAZIL  
HD 4/02 GD-10  
HD 4/021 GS-10 BRAZIL  
HD 4/21 DG-10  
HD 4/21 G-10  
HD 4/21 G-10 BRAZIL  
HD 4/22-10  
HD 7/11 DG-9  
HD 7/19 DG-13  
HD 7/19 DG-13 TURKEY  
HD 7/19 DGS-13  
HD 7/19 DGS-13 TURKEY  
HD 7/19 DGS-13

**EX / CROSS :**

**T16989**



**Description:**  
GROOVED NUT

**Packaging Unit:** 1

**OEM No :**  
674 356 0226

**Model:**  
HD 7/014 DG-16  
HD 7/014 DGS-16  
HD 7/014 DGS-16 TURKEY  
HD 7/016 DG-13  
HD 7/016 DSG-13  
HD 7/055 DCGS-13  
HD 7/056 DGS-13  
HD 7/056 DGS-16  
HD 7/09 DG-10  
HD 7/55 DCGS-13  
HD 7/56 DGS-13  
HL 2/13 D-6,4  
HL 2/4 L-6,4  
HL 2/4-6,4

**EX / CROSS :**  
070852 060000

**T14813**

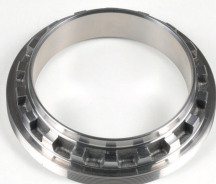

**Description:**  
GROOVED NUT

**Packaging Unit:** 1

**OEM No :**  
346 353 0825

**Model:**  
HD 7/014 DG-16  
HD 7/014 DGS-16  
HD 7/014 DGS-16 TURKEY  
HD 7/016 DG-13  
HD 7/016 DSG-13  
HD 7/09 DG-10

**EX / CROSS :**





<p><b>T11133</b></p> 	<p><b>Description:</b> GROOVED NUT</p> <p><b>OEM No :</b> 355 353 0325</p> <p><b>EX / CROSS :</b></p>	<p><b>Packaging Unit:</b> 1</p> <p><b>Model:</b>            HD 4/02 DG-10            HD 4/02 DG-10 BRAZIL            HD 4/02 GD-10            HD 4/021 GS-10 BRAZIL            HD 4/21 DG-10            HD 4/21 G-10            HD 4/21 G-10 BRAZIL            HD 4/22-10            HD 7/11 DG-9            HD 7/19 DG-13            HD 7/19 DG-13 TURKEY            HD 7/19 DGS-13            HD 7/19 DGS-13 TURKEY            HD 7/2 DG-10            HD 7/2 DLG-10            HD 7/2 DSG-10            HD 7/5 DG-10</p>
<p><b>T15297</b></p> 	<p><b>Description:</b> GROOVED NUT</p> <p><b>OEM No :</b> 346 353 0326</p> <p><b>EX / CROSS :</b></p>	<p><b>Packaging Unit:</b> 1</p> <p><b>Model:</b>            HD 7/014 DG-16            HD 7/014 DGS-16            HD 7/014 DGS-16 TURKEY            HD 7/016 DG-13            HD 7/016 DSG-13            HD 7/09 DG-10</p>
<p><b>T08971</b></p> 	<p><b>Description:</b> GROOVED NUT</p> <p><b>OEM No :</b> 346 353 0126</p> <p><b>EX / CROSS :</b></p>	<p><b>Packaging Unit:</b> 1</p> <p><b>Model:</b>            HD 7/014 DG-16            HD 7/014 DGS-16            HD 7/014 DGS-16 TURKEY            HD 7/016 DG-13            HD 7/016 DSG-13            HD 7/09 DG-10</p>
<p><b>T14449</b></p> 	<p><b>Description:</b> GROOVED NUT</p> <p><b>OEM No :</b> 346 353 0925</p> <p><b>EX / CROSS :</b></p>	<p><b>Packaging Unit:</b> 1</p> <p><b>Model:</b>            HD 7/014 DG-16            HD 7/014 DGS-16            HD 7/014 DGS-16 TURKEY            HD 7/016 DG-13            HD 7/016 DSG-13            HD 7/09 DG-10</p>
<p><b>T11132</b></p> 	<p><b>Description:</b> GROOVED NUT</p> <p><b>OEM No :</b> 371 353 0025</p> <p><b>EX / CROSS :</b> 355 353 0125</p>	<p><b>Packaging Unit:</b> 1</p> <p><b>Model:</b></p>



<p><b>T11991</b></p> 	<p><b>Description:</b> GROOVED NUT</p> <p><b>OEM No :</b> 355 353 0225</p> <p><b>EX / CROSS :</b></p>	<p><b>Packaging Unit:</b> 1</p> <p><b>Model:</b> HD 4/021 GS-10 BRAZIL HD 4/21 DG-10 HD 4/21 G-10 HD 4/21 G-10 BRAZIL HD 4/22-10 HD 7/11 DG-9 HD 7/19 DG-13 HD 7/19 DG-13 TURKEY HD 7/19 DGS-13 HD 7/19 DGS-13 TURKEY HD 7/19 DSG-13 HD 7/2 DG-10</p>
<p><b>T14764</b></p> 	<p><b>Description:</b> GROOVED NUT</p> <p><b>OEM No :</b> 346 350 0443</p> <p><b>EX / CROSS :</b></p>	<p><b>Packaging Unit:</b> 1</p> <p><b>Model:</b> HD 7/014 DG-16 HD 7/014 DGS-16 HD 7/014 DGS-16 TURKEY HD 7/016 DG-13 HD 7/016 DSG-13 HD 7/09 DG-10 HL 7/013 D-16 HL 7/013 DS-16 TURKEY HL 7/015 D-13 HL 7/015 D-13 TURKEY HL 7/015 DL-13 HL 7/015 DS-13 HL 7/02 DL-10 HL 7/021 D-10 HL 7/021 DL-10 HL 7/021 DS-10 HL 7/021 DS-10 HL 7/024 DL-12,3 HL 7/024 DL-12,3 HL 7/050 DCS-11,5 HL 7/050 DCS-13 HL 7/052 DS-13 HL 7/07 D-10 HL 7/07 D-11,5 HL 7/07 DL-10</p>
<p><b>T14773</b></p> 	<p><b>Description:</b> GROOVED NUT</p> <p><b>OEM No :</b> 652 353 0025</p> <p><b>EX / CROSS :</b> 346 353 0625</p>	<p><b>Packaging Unit:</b> 1</p> <p><b>Model:</b> HD 7/014 DG-16 HD 7/014 DGS-16 HD 7/014 DGS-16 TURKEY HD 7/016 DG-13 HD 7/016 DSG-13 HD 7/09 DG-10 HL 7/013 D-16 HL 7/013 DS-16 TURKEY HL 7/015 D-13 HL 7/015 D-13 TURKEY HL 7/015 DL-13 HL 7/015 DS-13 HL 7/02 DL-10 HL 7/021 D-10 HL 7/021 DL-10 HL 7/021 DS-10 HL 7/021 DS-10 HL 7/024 D-12,3 HL 7/024 DL-12,3 HL 7/050 DCS-11,5 HL 7/050 DCS-13 HL 7/052 DS-13 HL 7/07 D-10 HL 7/07 D-11,5 HL 7/07 DL-10</p>
<p><b>T15375</b></p> 	<p><b>Description:</b> GROOVED NUT</p> <p><b>OEM No :</b> 070852 055000</p> <p><b>EX / CROSS :</b></p>	<p><b>Packaging Unit:</b> 1</p> <p><b>Model:</b> HD 4/02 DG-10 HD 4/02 DG-10 BRAZIL HD 4/02 GD-10 HD 4/021 GS-10 BRAZIL HD 4/21 DG-10 HD 4/21 G-10 HD 4/21 G-10 BRAZIL HD 4/22-10 HD 7/11 DG-9 HD 7/19 DG-13 HD 7/19 DG-13 TURKEY HD 7/19 DGS-13 HD 7/19 DGS-13 TURKEY HD 7/19 DSG-13 HD 7/2 DG-10 HD 7/2 DLG-10 HD 7/19 DGS-13 TURKEY HD 7/19 DSG-13</p>
<p><b>T58398</b></p> 	<p><b>Description:</b> GROOVED NUT</p> <p><b>OEM No :</b> 944 350 0243</p> <p><b>EX / CROSS :</b> 944 353 0225 944 353 0325</p>	<p><b>Packaging Unit:</b> 1</p> <p><b>Model:</b> AL 7/1 D-7 AL 7/1 DS-7 AL 7/5 D-7 AL 7/8 D-8 HD 7/11 DG-9 HD 7/19 DG-13 HD 7/19 DG-13 TURKEY HD 7/19 DGS-13 HD 7/19 DGS-13 TURKEY HD 7/19 DSG-13 HD 7/2 DG-10 HD 7/2 DLG-10 HD 7/2 DSG-10 HD 7/5 DG-10 HD 7/55 DCGS-13 HD 7/56 DGS-13 HL 7/1 D-10 HL 7/1 DL-10 HL 7/1 L-10 HL 7/1 S-10 HL 7/1-10 HL 7/10 D-9 HL 7/18 D-13 HL 7/18 D-13 TURKEY</p>



**T63425**



**Description:**  
GROOVED NUT

**Packaging Unit:** 1

**OEM No :**  
389 990 5060

**Model:**

**EX / CROSS :**

**T19723**



**Description:**  
GROOVED NUT (M142X1,5)

**Packaging Unit:** 1

**OEM No :**  
942 353 0925

**Model:**

HD 7/055 DCGS-13  
HD 7/056 DGS-13  
HD 7/056 DGS-16  
HD 7/55 DCGS-13  
HD 7/56 DGS-13

**EX / CROSS :**  
942 353 0825  
942 353 0625

**T63438**



**Description:**  
GROOVED NUT (M155X1,5)

**Packaging Unit:** 1

**OEM No :**  
970 353 0025

**Model:**

HD 7/055 DCGS-13  
HD 7/056 DGS-13  
HD 7/056 DGS-16  
HL 2/30 C-5,6  
HL 2/31 C(S)-4,4  
HL 2/43 DC-6,2  
HL 2/46 DC-8,5  
HL 2/47 DC-6,8  
HL 6/1 DC(L,S)-13  
(REINFORCED)  
HL 6/1 DC(LC)-13 (OLD  
VERSION)  
HL 6/1 DC(LC)-13  
HL 7/055 DCS-13  
HO 6/1 DCL(S)-13  
HO 6/2 DCL(S)-13  
HO 6/4 DCL(S)-13  
HO 6/5 DCL(S)-13  
HO 6/6 DCL(S)-13  
HO 6/DCL-13

**EX / CROSS :**

**T14931**



**Description:**  
GROOVED NUT (M48X1,5)

**Packaging Unit:** 1

**OEM No :**  
355 353 0126

**Model:**

HD 4/02 DG-10  
HD 4/02 GD-10  
HD 4/021 GS-10 BRAZIL  
HD 4/21 DG-10  
HD 4/21 G-10  
HD 4/21 G-10 BRAZIL  
HD 4/22-10  
HD 7/11 DG-9  
HD 7/19 DG-13  
HD 7/19 DG-13 TURKEY  
HD 7/19 DGS-13  
HD 7/19 DGS-13 TURKEY  
HD 7/19 DSG-13  
HD 7/2 DG-10  
HD 7/2 DLG-10  
HD 7/2 DSG-10  
HD 7/5 DG-10

**EX / CROSS :**

**T14911**



**Description:**  
GROOVED NUT (M88X1,5)

**Packaging Unit:** 1

**OEM No :**  
942 356 0026

**Model:**

**EX / CROSS :**  
355 356 0126



T75766



**Description:**  
HOUSING DIFF.

**Packaging Unit:** 1

**OEM No :**  
948 350 0103

**Model:**  
HL 6/1 DC(LC)-13 (OLD  
VERSION)  
HL 6/3 DC(L,S)-13 (OLD  
VERSION)

**EX / CROSS :**

T93584



**Description:**  
HYDRAULIC PUMP

**Packaging Unit:** 1

**OEM No :**  
003 460 5080

**Model:**

**EX / CROSS :**  
002 460 0880  
003 460 1980  
002460 088080  
002 460 3980

T40495

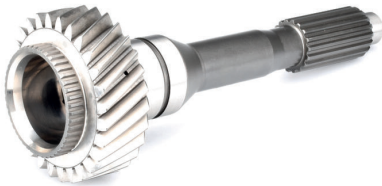

**Description:**  
INPUT SHAFT

**Packaging Unit:** 1

**OEM No :**  
976 262 4402

**Model:**  
G85-6/6,70-0,83

**EX / CROSS :**

T66679

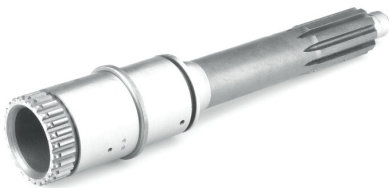

**Description:**  
INPUT SHAFT

**Packaging Unit:** 1

**OEM No :**  
387 262 1301

**Model:**  
GV4/110-6/9,0  
GV4/95-6/9,0

**EX / CROSS :**

T01155



**Description:**  
INPUT SHAFT (15T.)

**Packaging Unit:** 1

**OEM No :**  
322 262 0802

**Model:**  
G3/36-5/8,98  
G3/40-5/7,5

**EX / CROSS :**  
322 262 0102





T08597



**Description:**  
INPUT SHAFT (16-23T.)

**Packaging Unit:** 1

**OEM No :**  
381 262 0102

**Model:**  
G3/50-5/8,5  
G3/50-5/8,5 Brazil

**EX / CROSS :**

T08301



**Description:**  
INPUT SHAFT (16-8T.)

**Packaging Unit:** 1

**OEM No :**  
314 262 0902

**Model:**  
G2/24-5/7,31

**EX / CROSS :**

314 262 0502  
314 262 0302  
314 262 0202  
308 262 7002

T08299



**Description:**  
INPUT SHAFT (17-8T.)

**Packaging Unit:** 1

**OEM No :**  
314 262 0802

**Model:**  
G2/24-5/6,71

**EX / CROSS :**

314 262 0402

T07571



**Description:**  
INPUT SHAFT (17T.)

**Packaging Unit:** 1

**OEM No :**  
340 262 0502

**Model:**  
G3/40-5/7,5 Indonesian

**EX / CROSS :**

340 262 0402  
340 262 0202

T08601



**Description:**  
INPUT SHAFT (18-23T.)

**Packaging Unit:** 1

**OEM No :**  
383 262 0802

**Model:**  
G3/61-5/6,1

**EX / CROSS :**



T08281



**Description:**  
INPUT SHAFT (18-24T.)

**Packaging Unit:** 1

**OEM No :**  
302 262 1502

**Model:**  
G3/60-5/6,1 Brazil

**EX / CROSS :**

T45640



**Description:**  
INPUT SHAFT (18-28-46T.)

**Packaging Unit:** 1

**OEM No :**  
976 262 1402

**Model:**  
G85-6/6,70-0,83

**EX / CROSS :**  
976 262 1502  
975 262 0102  
695 262 0002

T45236



**Description:**  
INPUT SHAFT (18-28-46T.)

**Packaging Unit:** 1

**OEM No :**  
976 262 1702

**Model:**  
G85-6/6,70-0,83

**EX / CROSS :**  
976 262 1802

T45625



**Description:**  
INPUT SHAFT (18-28-46T.)

**Packaging Unit:** 1

**OEM No :**  
976 262 0502

**Model:**

**EX / CROSS :**  
976 262 0202

T49282



**Description:**  
INPUT SHAFT (18-28-46T.)

**Packaging Unit:** 1

**OEM No :**  
976 262 2302

**Model:**  
G85-6/6,70-0,83

**EX / CROSS :**  
976 262 2402

<p><b>T15516</b></p> 	<p><b>Description:</b> INPUT SHAFT (23-23-10T.)</p> <p><b>OEM No :</b> 385 262 2602</p> <p><b>EX / CROSS :</b></p>	<p><b>Packaging Unit:</b> 1</p> <p><b>Model:</b> G3/65-8/9,29 G3/65-9/13,36</p>
<p><b>T15618</b></p> 	<p><b>Description:</b> INPUT SHAFT (23-23-10T.)</p> <p><b>OEM No :</b> 385 262 2502</p> <p><b>EX / CROSS :</b></p>	<p><b>Packaging Unit:</b> 1</p> <p><b>Model:</b> G3/65-8/9,29 G3/65-9/13,36</p>
<p><b>T61112</b></p> 	<p><b>Description:</b> INPUT SHAFT (24T.)</p> <p><b>OEM No :</b> 970 262 0502</p> <p><b>EX / CROSS :</b> 970 262 0602</p>	<p><b>Packaging Unit:</b> 1</p> <p><b>Model:</b> G60-6/9,20-1,00</p>
<p><b>T85487</b></p> 	<p><b>Description:</b> INPUT SHAFT (26T.)</p> <p><b>OEM No :</b> 1324 302 016</p> <p><b>EX / CROSS :</b></p>	<p><b>Packaging Unit:</b> 1</p> <p><b>Model:</b></p>
<p><b>T38796</b></p> 	<p><b>Description:</b> INPUT SHAFT (27-51-18T.)</p> <p><b>OEM No :</b> 945 262 7502</p> <p><b>EX / CROSS :</b> 945 262 3202 945 262 3102 945 262 3002 945 262 2902</p>	<p><b>Packaging Unit:</b> 1</p> <p><b>Model:</b> G221-9/10,19-1,00</p>



T38794



**Description:**  
INPUT SHAFT (27-51-18T.)

**Packaging Unit:** 1

**OEM No :**  
945 262 6702

**Model:**  
G221-9/10,19-1,00

**EX / CROSS :**  
945 262 1802  
945 262 1702  
945 262 1602  
945 262 1502

T53156

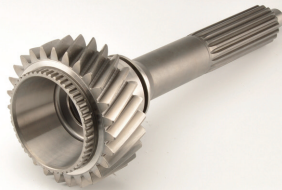

**Description:**  
INPUT SHAFT (27-51-18T.)

**Packaging Unit:** 1

**OEM No :**  
945 262 4082

**Model:**  
G221-9/10,19-1,00

**EX / CROSS :**

T63273



**Description:**  
INPUT SHAFT (27-51-18T.)

**Packaging Unit:** 1

**OEM No :**  
945 262 4202

**Model:**  
G221-9/10,19-1,00

**EX / CROSS :**

T76030



**Description:**  
INPUT SHAFT (27-51-18T.)

**Packaging Unit:** 1

**OEM No :**  
945 262 4282

**Model:**  
G221-9/10,19-1,00

**EX / CROSS :**

945 262 4182

T82756



**Description:**  
INPUT SHAFT (28T.)

**Packaging Unit:** 1

**OEM No :**  
947 262 4202

**Model:**  
G131-9  
G141-9

**EX / CROSS :**  
974 262 1302  
947 262 1302



<p><b>T53130</b></p> 	<p><b>Description:</b> INPUT SHAFT (30-51-10T.)</p> <p><b>OEM No :</b> 656 262 6102</p> <p><b>EX / CROSS :</b> 656 262 6082 656 262 3282 389 262 6602 389 262 6502</p>	<p><b>Packaging Unit:</b> 1</p> <p><b>Model:</b> GO210-6/6,53-0,80 GO230-6/6,5-0,8</p>
<p><b>T69290</b></p> 	<p><b>Description:</b> INPUT SHAFT (30-51-10T.)</p> <p><b>OEM No :</b> 656 262 8082</p> <p><b>EX / CROSS :</b></p>	<p><b>Packaging Unit:</b> 1</p> <p><b>Model:</b> GO210-6/6,53-0,80</p>
<p><b>T61890</b></p> 	<p><b>Description:</b> INPUT SHAFT (38-26-10T.)</p> <p><b>OEM No :</b> 389 262 7902</p> <p><b>EX / CROSS :</b> 389 262 7802</p>	<p><b>Packaging Unit:</b> 1</p> <p><b>Model:</b> GO190-6/8,2-1,0</p>
<p><b>T61893</b></p> 	<p><b>Description:</b> INPUT SHAFT (38-26-10T.)</p> <p><b>OEM No :</b> 389 262 8102</p> <p><b>EX / CROSS :</b> 389 262 8002</p>	<p><b>Packaging Unit:</b> 1</p> <p><b>Model:</b> GO190-6/8,2-1,0</p>
<p><b>T54743</b></p> 	<p><b>Description:</b> INPUT SHAFT (38-26-10T.)</p> <p><b>OEM No :</b> 656 262 2882</p> <p><b>EX / CROSS :</b> 656 262 9802</p>	<p><b>Packaging Unit:</b> 1</p> <p><b>Model:</b> GO170-6/8,2-1,0 GO190-6/8,2-1,0</p>

**T45232**



**Description:**  
INPUT SHAFT (46-24-18T.)

**Packaging Unit:** 1

**OEM No :**  
970 262 1902

**Model:**  
G60-6/9,20-1,00

**EX / CROSS :**  
970 262 2002

**T12283**



**Description:**  
INPUT SHAFT (60-10T.)

**Packaging Unit:** 1

**OEM No :**  
389 262 3901

**Model:**  
G125-16/14,0

**EX / CROSS :**

**T15525**



**Description:**  
INPUT SHAFT (60-10T.)

**Packaging Unit:** 1

**OEM No :**  
389 262 6501

**Model:**  
G210-16/14,2-0,83

**EX / CROSS :**  
389 262 5101

**T15547**



**Description:**  
INPUT SHAFT (60-10T.)

**Packaging Unit:** 1

**OEM No :**  
389 262 3701

**Model:**  
G155-16/11,9  
G155-16/14,0  
G180-16/11,9  
G180-16/14,0

**EX / CROSS :**

**T12217**



**Description:**  
INPUT SHAFT (60-10T.)

**Packaging Unit:** 1

**OEM No :**  
389 262 2901

**Model:**  
G155-16/11,9  
G155-16/14,0  
G180-16/11,9  
G180-16/14,0  
G200-16/11,9

**EX / CROSS :**

<p><b>T15548</b></p> 	<p><b>Description:</b> INPUT SHAFT (60-10T.)</p> <p><b>OEM No :</b> 389 262 6601</p> <p><b>EX / CROSS :</b></p>	<p><b>Packaging Unit:</b> 1</p> <p><b>Model:</b> G210-16/14,2-0,83 G240-16/11,72-0,69</p>
<p><b>T17832</b></p> 	<p><b>Description:</b> INPUT SHAFT (60-18T.)</p> <p><b>OEM No :</b> 389 262 8301</p> <p><b>EX / CROSS :</b> 945 262 0303 389 262 6301 945 260 0303</p>	<p><b>Packaging Unit:</b> 1</p> <p><b>Model:</b> G240-16/11,72-0,69 G260-16/9,75-0,57</p>
<p><b>T49962</b></p> 	<p><b>Description:</b> INPUT SHAFT (60-18T.)</p> <p><b>OEM No :</b> 945 262 4403</p> <p><b>EX / CROSS :</b> 945 262 1001 389 262 0003 945 262 0703 389 262 5601</p>	<p><b>Packaging Unit:</b> 1</p> <p><b>Model:</b> G210-16/14,2-0,83 G240-16/11,72-0,69 G260-16/9,75-0,57</p>
<p><b>T17831</b></p> 	<p><b>Description:</b> INPUT SHAFT (60-18T.)</p> <p><b>OEM No :</b> 389 262 8201</p> <p><b>EX / CROSS :</b></p>	<p><b>Packaging Unit:</b> 1</p> <p><b>Model:</b> G210-16/14,2-0,83 G230-16/14,2-0,83</p>
<p><b>T18845</b></p> 	<p><b>Description:</b> INPUT SHAFT (60-18T.)</p> <p><b>OEM No :</b> 389 262 6201</p> <p><b>EX / CROSS :</b></p>	<p><b>Packaging Unit:</b> 1</p> <p><b>Model:</b> G210-16/14,2-0,83</p>

<p><b>T17833</b></p> 	<p><b>Description:</b> INPUT SHAFT (60T.)</p> <p><b>OEM No :</b> 976 262 2501</p> <p><b>EX / CROSS :</b> 976 262 2401</p> <p><b>Model:</b> G100-12</p>	<p><b>Packaging Unit:</b> 1</p>
<p><b>T38535</b></p> 	<p><b>Description:</b> INPUT SHAFT (60T.)</p> <p><b>OEM No :</b> 389 262 7601</p> <p><b>EX / CROSS :</b> 945 262 3201 945 262 1801 945 262 1203</p> <p><b>Model:</b> G211-16/17,03-1,0 G231-16/17,03-1,0</p>	<p><b>Packaging Unit:</b> 1</p>
<p><b>T38825</b></p> 	<p><b>Description:</b> INPUT SHAFT (66-18T.)</p> <p><b>OEM No :</b> 930 262 0403</p> <p><b>EX / CROSS :</b> 948 262 0202</p> <p><b>Model:</b> G281-12 Klauen G330-12/11,64-0,78</p>	<p><b>Packaging Unit:</b> 1</p>
<p><b>T94334</b></p> 	<p><b>Description:</b> INPUT SHAFT (66T.)</p> <p><b>OEM No :</b> 656 262 7982</p> <p><b>EX / CROSS :</b></p> <p><b>Model:</b> GO240-8/6,57-0,63</p>	<p><b>Packaging Unit:</b> 1</p>
<p><b>T66813</b></p> 	<p><b>Description:</b> INPUT SHAFT (66T.)</p> <p><b>OEM No :</b> 930 262 1003</p> <p><b>EX / CROSS :</b> 930 262 0003</p> <p><b>Model:</b> G241-16 Klauen G280-16 Klauen</p>	<p><b>Packaging Unit:</b> 1</p>





<p><b>T85476</b></p> 	<p><b>Description:</b> KEY</p> <p><b>OEM No :</b> 006888 003011</p> <p><b>EX / CROSS :</b></p>	<p><b>Packaging Unit:</b> 1</p> <p><b>Model:</b> G3/65-8/9,29 G3/65-9/13,36</p>
<p><b>T40118</b></p> 	<p><b>Description:</b> KING PIN SET</p> <p><b>OEM No :</b> 675 330 0019</p> <p><b>EX / CROSS :</b> 670 330 0219</p>	<p><b>Packaging Unit:</b> 1</p> <p><b>Model:</b></p>
<p><b>T39049</b></p> 	<p><b>Description:</b> LOCK RING</p> <p><b>OEM No :</b> 389 262 0773</p> <p><b>EX / CROSS :</b></p>	<p><b>Packaging Unit:</b> 1</p> <p><b>Model:</b> G181-9 G200-16/11,9 G210-16/14,2-0,83 G211-16/17,03-1,0 G221-9/10,19-1,00 G230-16/14,2-0,83 G231-16/17,03-1,0 G240-16/11,72-0,69 G241-16 Klauen G260-16/9,75-0,57 G280-16 Klauen G281-12 Klauen G330-12/11,64-0,78</p>
<p><b>T70569</b></p> 	<p><b>Description:</b> LOCK RING</p> <p><b>OEM No :</b> 070952 060102</p> <p><b>EX / CROSS :</b></p>	<p><b>Packaging Unit:</b> 5</p> <p><b>Model:</b> HD 7/014 DG-16 HD 7/014 DGS-16 HD 7/016 DG-13 HD 7/016 DSG-13 HD 7/055 DCGS-13 HD 7/056 DGS-13 HD 7/056 DGS-16 HD 7/09 DG-10 HD 7/55 DCGS-13 HD 7/56 DGS-13 HL 2/13 D-6,4 HL 2/4 L-6,4</p>
<p><b>T55335</b></p> 	<p><b>Description:</b> LOW SPEED GEAR (39-37T.)</p> <p><b>OEM No :</b> 945 262 8311</p> <p><b>EX / CROSS :</b> 945 262 8211 945 262 8111 945 262 7911 945 262 7811</p>	<p><b>Packaging Unit:</b> 1</p> <p><b>Model:</b> G181-9 G221-9/10,19-1,00</p>

**T66884**



**Description:**  
LOW SPEED GEAR (41T.)

**Packaging Unit:** 1

**OEM No :**  
947 262 1811

**Model:**  
G131-9  
G141-9

**EX / CROSS :**  
  
947 262 1311

**T66801**



**Description:**  
MAIN SHAFT

**Packaging Unit:** 1

**OEM No :**  
970 262 0505

**Model:**  
G71-6  
G90-6

**EX / CROSS :**

**T66947**



**Description:**  
MAIN SHAFT

**Packaging Unit:** 1

**OEM No :**  
947 262 0305

**Model:**  
G131-9  
G141-9

**EX / CROSS :**

**T58207**



**Description:**  
MAIN SHAFT

**Packaging Unit:** 1

**OEM No :**  
930 262 0605

**Model:**  
G241-16 Klauen  
G280-16 Klauen

**EX / CROSS :**  
930 262 0305  
930 260 0605

**T94348**



**Description:**  
MAIN SHAFT

**Packaging Unit:** 1

**OEM No :**  
656 262 0705

**Model:**  
GO240-8/6,57-0,63  
GO250-8/6,57-0,63

**EX / CROSS :**

**T40496**



**Description:**  
MAIN SHAFT

**Packaging Unit:** 1

**OEM No :**  
976 262 3105

**Model:**  
G85-6/6,70-0,83

**EX / CROSS :**

**T53285**



**Description:**  
MAIN SHAFT

**Packaging Unit:** 1

**OEM No :**  
930 262 2105

**Model:**  
G181-9  
G221-9/10,19-1,00

**EX / CROSS :**  
930 262 1305

**T01158**



**Description:**  
MAIN SHAFT

**Packaging Unit:** 1

**OEM No :**  
322 262 0705

**Model:**  
G3/36-5/8,98  
G3/40-5/7,5  
G3/40-5/7,5 Indonesian

**EX / CROSS :**  
322 262 0505  
322 262 0005

**T08325**



**Description:**  
MAIN SHAFT

**Packaging Unit:** 1

**OEM No :**  
337 262 0505

**Model:**  
G3/60-5/6,1  
G3/60-5/6,1 Brazil  
G3/61-5/6,1  
G3/61-5/6,1 Brazil  
GO3/60-5/5,4  
GO3/60-5/5,4 Turkey

**EX / CROSS :**

**T53261**



**Description:**  
MAIN SHAFT

**Packaging Unit:** 1

**OEM No :**  
947 262 1705

**Model:**  
G211-12 Klauen  
G230-12 Klauen

**EX / CROSS :**  
947 262 1605  
947 262 1505  
947 262 0705



**T12207**



**Description:**

MAIN SHAFT (22-28-32-28T.)

**Packaging Unit:** 1

**OEM No :**

389 262 1505

**Model:**

G155-16/11,9  
G155-16/14,0  
G180-16/11,9  
G180-16/14,0  
G200-16/11,9

**EX / CROSS :**

389 262 1205

**T53120**



**Description:**

MAIN SHAFT (22-34-35-30-24T.)

**Packaging Unit:** 1

**OEM No :**

656 262 0805

**Model:**

**EX / CROSS :**

389 262 4505

389 262 4605

389 262 4005

389 262 3205

**T19669**



**Description:**

MAIN SHAFT (22-34-35-32-24T.)

**Packaging Unit:** 1

**OEM No :**

976 262 2105

**Model:**

G100-12

**EX / CROSS :**

976 262 2005

976 262 1505

976 262 1305

976 262 1105

**T45638**

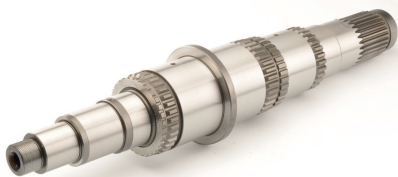

**Description:**

MAIN SHAFT (24-40-40-32-26T.)

**Packaging Unit:** 1

**OEM No :**

976 262 1205

**Model:**

G85-6/6,70-0,83

**EX / CROSS :**

976 262 0705

**T45646**



**Description:**

MAIN SHAFT (24-40-40-32-26T.)

**Packaging Unit:** 1

**OEM No :**

976 262 1705

**Model:**

G85-6/6,70-0,83  
GO110-6/6,1-0,747

**EX / CROSS :**

976 262 1405

976 262 2905

975 262 0005



**T17266**



**Description:**

MAIN SHAFT (28-32-28-22T.)

**Packaging Unit:** 1

**OEM No :**

389 262 1305

**Model:**

G155-9/15,9  
GO210-8/11,8

**EX / CROSS :**

**T19848**



**Description:**

MAIN SHAFT (28-32-28-22T.)

**Packaging Unit:** 1

**OEM No :**

389 262 1605

**Model:**

G125-16/14,0  
G135-16/11,9

**EX / CROSS :**

**T18025**



**Description:**

MAIN SHAFT (28-32-28-28T.)

**Packaging Unit:** 1

**OEM No :**

389 262 2405

**Model:**

G210-16/14,2-0,83  
G240-16/11,72-0,69

**EX / CROSS :**

**T55331**



**Description:**

MAIN SHAFT (28-32-32-24T.)

**Packaging Unit:** 1

**OEM No :**

945 262 1205

**Model:**

G221-9/10,19-1,00

**EX / CROSS :**

**T61109**



**Description:**

MAIN SHAFT (28-40-40-32-26)

**Packaging Unit:** 1

**OEM No :**

970 262 0105

**Model:**

G60-6/9,20-1,00

**EX / CROSS :**

**T51905**



**Description:**

MAIN SHAFT (28-40-40-32-26T.)

**Packaging Unit:** 1

**OEM No :**

970 262 0405

**Model:**

G60-6/9,20-1,00

**EX / CROSS :**

970 262 1005

970 262 0205

**T17863**



**Description:**

MAIN SHAFT (32-32-28-28T.)

**Packaging Unit:** 1

**OEM No :**

945 262 4505

**Model:**

G210-16/14,2-0,83  
G211-16/17,03-1,0  
G230-16/14,2-0,83  
G231-16/17,03-1,0  
G240-16/11,72-0,69  
G260-16/9,75-0,57

**EX / CROSS :**

945 262 3505

**T17383**



**Description:**

MAIN SHAFT (32-32-28-28T.)

**Packaging Unit:** 1

**OEM No :**

945 262 3605

**Model:**

G210-16/14,2-0,83  
G211-16/17,03-1,0  
G230-16/14,2-0,83  
G231-16/17,03-1,0  
G240-16/11,72-0,69  
G260-16/9,75-0,57

**EX / CROSS :**

945 262 1905

389 262 2705

**T57313**



**Description:**

MAIN SHAFT (32-32-28-28T.)

**Packaging Unit:** 1

**OEM No :**

930 262 1205

**Model:**

G230-16/14,2-0,83  
G240-16/11,72-0,69

**EX / CROSS :**

930 262 2405-OLD

**T94579**



**Description:**

MAIN SHAFT (32-32-28-28T.) W/RIVET

**Packaging Unit:** 1

**OEM No :**

930 262 1005

**Model:**

G241-16 Klauen  
G280-16 Klauen

**EX / CROSS :**

**T38827**



**Description:**  
MAIN SHAFT (32-32-28T.)

**Packaging Unit:** 1

**OEM No :**  
930 262 0805

**Model:**  
G281-12 Klauen  
G330-12/11,64-0,78

**EX / CROSS :**  
930 262 2205

**T57229**



**Description:**  
MAIN SHAFT (32-32-28T.)

**Packaging Unit:** 1

**OEM No :**  
930 262 0205

**Model:**  
G281-12 Klauen  
G330-12/11,64-0,78

**EX / CROSS :**

**T70803**



**Description:**  
MAIN SHAFT (32-32-28T.) W/RIVET

**Packaging Unit:** 1

**OEM No :**  
960 262 0105

**Model:**  
G281-12 Klauen  
G330-12/11,64-0,78

**EX / CROSS :**  
948 262 0205  
960 262 3805

**T66844**



**Description:**  
MEMBRANE

**Packaging Unit:** 2

**OEM No :**  
TAS66844

**Model:**

**EX / CROSS :**

**T44012**



**Description:**  
MOULDED CAM

**Packaging Unit:** 1

**OEM No :**  
387 260 2873/M

**Model:**

**EX / CROSS :**



**T56551**



**Description:**  
NEEDLE BEARING

**Packaging Unit:** 1

**OEM No :**  
019 981 9210

**Model:**  
G140-8  
G181-9  
G221-9/10,19-1,00  
GO240-8/6,57-0,63  
GO250-8/6,57-0,63

**EX / CROSS :**  
020 981 0110  
023 981 1210  
023 981 5110

**T58423**



**Description:**  
NEEDLE BEARING

**Packaging Unit:** 1

**OEM No :**  
019 981 9010

**Model:**  
G181-9  
G221-9/10,19-1,00

**EX / CROSS :**  
020 981 0010

**T45570**



**Description:**  
NEEDLE BEARING (32X40X49,2)

**Packaging Unit:** 1

**OEM No :**  
018 981 5710

**Model:**  
G60-6/9,20-1,00  
G71-6  
G85-6/6,70-0,83  
G90-6  
GO110-6/6,1-0,747

**EX / CROSS :**  
017 981 6110  
017 981 6010  
F-224448.K-HLA

**T45205**



**Description:**  
NEEDLE BEARING (37X57X31)

**Packaging Unit:** 1

**OEM No :**  
976 981 0012

**Model:**  
G60-6/9,20-1,00  
G71-6  
G85-6/6,70-0,83  
G90-6  
GO110-6/6,1-0,747

**EX / CROSS :**  
F 224451.04  
002 981 6312  
002 981 6012  
002 981 5912

**T65899**



**Description:**  
NEEDLE BEARING (37X57X31)





**Packaging Unit:**



**OEM No :**  
967 981 0012

**Model:**  
G70-6  
G71-6  
G85-6/6,70-0,83  
G90-6

**EX / CROSS :**



<p><b>T46630</b></p> 	<p><b>Description:</b> NEEDLE BEARING (42X50X51)</p> <p><b>OEM No :</b> 012 981 8910</p> <p><b>EX / CROSS :</b> F-207054 012 981 9010 013 981 0210 019 981 1310</p>	<p><b>Packaging Unit:</b> 1</p> <p><b>Model:</b> G155-16/11,9 G155-16/14,0 G155-9/15,9 G180-16/11,9 G180-16/14,0 G181-9 G200-16/11,9 G210-16/14,2-0,83 G211-16/17,03-1,0 G221-9/10,19-1,00 G230-16/14,2-0,83 G231-16/17,03-1,0 G240-16/11,72-0,69 G241-16 Klauen G260-16/9,75-0,57 G280-16 Klauen G281-12 Klauen G330-12/11,64-0,78 GO210-8/11,8</p>
<p><b>T56498</b></p> 	<p><b>Description:</b> NEEDLE BEARING (48X60X31)</p> <p><b>OEM No :</b> 015 981 4110</p> <p><b>EX / CROSS :</b> 019 981 0510</p>	<p><b>Packaging Unit:</b> 1</p> <p><b>Model:</b> GO170-6/8,2-1,0 GO190-6/8,2-1,0 GO210-6/6,53-0,80 GO230-6/6,5-0,8 GO240-8/6,57-0,63 GO250-8/6,57-0,63 GO4/160-6/8,2</p>
<p><b>T51996</b></p> 	<p><b>Description:</b> NEEDLE BEARING (50X55X20)</p> <p><b>OEM No :</b> 017 981 3710</p> <p><b>EX / CROSS :</b></p>	<p><b>Packaging Unit:</b> 1</p> <p><b>Model:</b></p>
<p><b>T49227</b></p> 	<p><b>Description:</b> NEEDLE BEARING (50X56X43,7)</p> <p><b>OEM No :</b> 018 981 3610</p> <p><b>EX / CROSS :</b> F-225955 018 981 0110 018 981 3010</p>	<p><b>Packaging Unit:</b> 1</p> <p><b>Model:</b> G85-6/6,70-0,83 GO110-6/6,1-0,747</p>
<p><b>T85440</b></p> 	<p><b>Description:</b> NEEDLE BEARING (54X62X27)</p> <p><b>OEM No :</b> 014 981 6310</p> <p><b>EX / CROSS :</b> 000 981 5111</p>	<p><b>Packaging Unit:</b> 1</p> <p><b>Model:</b></p>

<p><b>T51998</b></p> 	<p><b>Description:</b> NEEDLE BEARING (55X60X20)</p> <p><b>OEM No :</b> 017 981 3810</p> <p><b>EX / CROSS :</b> K55X60X20</p>	<p><b>Packaging Unit:</b> 1</p> <p><b>Model:</b></p>
<p><b>T52402</b></p> 	<p><b>Description:</b> NEEDLE BEARING (60X68X54)</p> <p><b>OEM No :</b> 019 981 6010</p> <p><b>EX / CROSS :</b> 019 981 5810</p>	<p><b>Packaging Unit:</b> 1</p> <p><b>Model:</b> G131-9 G141-9 GO170-6/8,2-1,0 GO190-6/8,2-1,0 GO210-6/6,53-0,80 GO230-6/6,5-0,8</p>
<p><b>T49303</b></p> 	<p><b>Description:</b> NEEDLE BEARING (63X71X44)</p> <p><b>OEM No :</b> 018 981 5610</p> <p><b>EX / CROSS :</b> 017 981 5310 017 981 5210</p>	<p><b>Packaging Unit:</b> 1</p> <p><b>Model:</b> G60-6/9,20-1,00 G85-6/6,70-0,83</p>
<p><b>T49252</b></p> 	<p><b>Description:</b> NEEDLE BEARING (63X71X50,8)</p> <p><b>OEM No :</b> 023 981 8510</p> <p><b>EX / CROSS :</b> 023 981 2910 019 981 5710 019 981 5310</p>	<p><b>Packaging Unit:</b> 1</p> <p><b>Model:</b> GO110-6/6,1-0,747</p>
<p><b>T67044</b></p> 	<p><b>Description:</b> NEEDLE BEARING (64X72X44,6)</p> <p><b>OEM No :</b> 022 981 2310</p> <p><b>EX / CROSS :</b> 022 981 2210</p>	<p><b>Packaging Unit:</b> 1</p> <p><b>Model:</b> G211-12 Klauen G230-12 Klauen</p>



T51992



**Description:**

NEEDLE BEARING (65X70X20)

**Packaging Unit:** 1

**OEM No :**

017 981 3510

**Model:**

**EX / CROSS :**

T67005



**Description:**

NEEDLE BEARING (68X76X42)

**Packaging Unit:** 1

**OEM No :**

021 981 5210

**Model:**

G131-9  
G141-9

**EX / CROSS :**

T58362



**Description:**

NEEDLE BEARING (68X76X55)

**Packaging Unit:** 1

**OEM No :**

009 981 4510

**Model:**

G181-9  
G221-9/10,19-1,00  
GV4/110-6/9,0  
GV4/95-6/9,0

**EX / CROSS :**

019 981 9110

009 981 1910

T51994



**Description:**

NEEDLE BEARING (70X76X20)

**Packaging Unit:** 1

**OEM No :**

017 981 3610

**Model:**

**EX / CROSS :**

T49233



**Description:**

NEEDLE BEARING (72X80X29,8)

**Packaging Unit:** 1

**OEM No :**

023 981 8210

**Model:**

GO110-6/6,1-0,747

**EX / CROSS :**

018 981 9510

017 997 5710

017 981 5710

017 981 5610



**T49245**



**Description:**

NEEDLE BEARING (72X80X40)

**Packaging Unit:** 1

**OEM No :**

018 981 5310

**Model:**

G56-6  
G60-6/9,20-1,00  
G70-6  
G71-6  
G85-6/6,70-0,83  
G90-6  
GO110-6/6,1-0,747

**EX / CROSS :**

017 981 5010

002 981 6112

017 981 5110

**T57279**



**Description:**

NEEDLE BEARING (75X83X48)

**Packaging Unit:** 1

**OEM No :**

022 981 6010

**Model:**

G281-12 Klauen  
G330-12/11,64-0,78

**EX / CROSS :**

022 981 5610

**T55466**



**Description:**

NEEDLE BEARING (75X83X48)

**Packaging Unit:** 1

**OEM No :**

945 981 0010

**Model:**

G100-12  
G210-16/14,2-0,83  
G211-16/17,03-1,0  
G230-16/14,2-0,83  
G231-16/17,03-1,0  
G240-16/11,72-0,69  
G241-16 Klauen  
G260-16/9,75-0,57  
G280-16 Klauen

**EX / CROSS :**

008 981 9210

018 981 7610

018 981 8110

019 981 2310

**T46634**



**Description:**

NEEDLE BEARING (75X83X55)

**Packaging Unit:** 1

**OEM No :**

019 981 4410

**Model:**

G131-9  
G141-9  
G155-16/11,9  
G155-16/14,0  
G155-9/15,9  
G180-16/11,9  
G180-16/14,0  
G200-16/11,9  
G210-16/14,2-0,83  
G211-12 Klauen  
G211-16/17,03-1,0  
G230-12 Klauen  
G230-16/14,2-0,83  
G231-16/17,03-1,0  
G240-16/11,72-0,69  
G260-16/9,75-0,57  
G4/110-6/9,0  
GO210-8/11,8  
GO4/110-5/5,1  
GO4/130-6/7,18  
GO4/160-6/7,18  
GV4/95-6/9,0

**EX / CROSS :**

F-57368.01

007 981 4210

008 981 8310

009 981 0010

**T60990**



**Description:**

NEEDLE BEARING (78X86X33)

**Packaging Unit:** 1

**OEM No :**

013 981 2610

**Model:**





G125-16/14,0  
G135-16/11,9  
G230-16/14,2-0,83  
G241-16 Klauen  
G260-16/9,75-0,57  
G280-16 Klauen

**EX / CROSS :**





013 981 1810

013 981 1710







<p><b>T46626</b></p> 	<p><b>Description:</b> NEEDLE BEARING (78X86X35)</p> <p><b>OEM No :</b> 009 981 1510</p> <p><b>EX / CROSS :</b> 018 981 7510 008 981 9310 012 981 9110 017 981 7810</p>	<p><b>Packaging Unit:</b> 1</p> <p><b>Model:</b> G100-12 G155-16/11,9 G155-16/14,0 G180-16/11,9 G180-16/14,0 G200-16/11,9 G210-16/14,2-0,83 G211-16/17,03-1,0 G230-16/14,2-0,83 G231-16/17,03-1,0 G240-16/11,72-0,69 G241-16 Klauen G260-16/9,75-0,57 G280-16 Klauen G4/95-6/9,0 GO170-6/8,2-1,0 GO190-6/8,2-1,0 GO210-6/6,53-0,80 GO230-6/6,5-0,8 GO4/105-6/7,18 GO4/120-6/7,18 GO4/160-6/8,2 GO4/95-5/5,1 GV4/110-6/9,0</p>
<p><b>T57122</b></p> 	<p><b>Description:</b> NEEDLE BEARING (84X90X39,5)</p> <p><b>OEM No :</b> 018 981 6410</p> <p><b>EX / CROSS :</b></p>	<p><b>Packaging Unit:</b> 1</p> <p><b>Model:</b> G211-16/17,03-1,0 G231-16/17,03-1,0 G241-16 Klauen G280-16 Klauen</p>
<p><b>T67085</b></p> 	<p><b>Description:</b> NEEDLE BEARING (84X90X48)</p> <p><b>OEM No :</b> 022 981 2110</p> <p><b>EX / CROSS :</b> 022 981 2010</p>	<p><b>Packaging Unit:</b> 1</p> <p><b>Model:</b> G211-12 Klauen G230-12 Klauen</p>
<p><b>T57217</b></p> 	<p><b>Description:</b> NEEDLE BEARING (84X90X55)</p> <p><b>OEM No :</b> 022 981 7910</p> <p><b>EX / CROSS :</b> 022 981 5310</p>	<p><b>Packaging Unit:</b> 1</p> <p><b>Model:</b> G281-12 Klauen G330-12/11,64-0,78</p>
<p><b>T67089</b></p> 	<p><b>Description:</b> NEEDLE BEARING (85X93X37)</p> <p><b>OEM No :</b> 019 981 0810</p> <p><b>EX / CROSS :</b> 012 981 9410 009 981 1610 008 981 9410</p>	<p><b>Packaging Unit:</b> 1</p> <p><b>Model:</b> G155-16/11,9 G155-16/14,0 G180-16/11,9 G180-16/14,0 G200-16/11,9 G4/65-7/11,0 G4/95-6/9,0 GO4/105-6/7,18 GO4/120-6/7,18 GO4/95-5/5,1 GV4/110-6/9,0</p>



<p><b>T56487</b></p> 	<p><b>Description:</b> NEEDLE BEARING (85X93X46)</p> <p><b>Packaging Unit:</b> 1</p> <p><b>OEM No :</b> 021 981 9410</p> <p><b>Model:</b> G4/110-6/9,0 G4/95-6/9,0 G4/95-7/11,0 GO170-6/8,2-1,0 GO190-6/8,2-1,0 GO210-6/6,53-0,80 GO230-6/6,5-0,8 GO4/105-6/7,18 GO4/110-5/5,1 GO4/120-6/7,18 GO4/130-6/7,18 GO4/160-6/7,18</p> <p><b>EX / CROSS :</b> 019 981 0610 008 981 8510 019 981 6210 008 981 9810</p>
<p><b>T46615</b></p> 	<p><b>Description:</b> NEEDLE BEARING (85X93X53)</p> <p><b>Packaging Unit:</b> 1</p> <p><b>OEM No :</b> 018 981 6610</p> <p><b>Model:</b> G125-16/14,0 G135-16/11,9 G140-8 G155-16/11,9 G155-16/14,0 G155-9/15,9 G180-16/11,9 G180-16/14,0 G200-16/11,9 G210-16/14,2-0,83 G211-16/17,03-1,0 G230-16/14,2-0,83</p> <p><b>EX / CROSS :</b> F-95451.02 010 981 5310 010 981 6410 012 981 9310</p> <p><b>Model:</b> G231-16/17,03-1,0 G240-16/11,72-0,69 G241-16 Klauen G260-16/9,75-0,57 G280-16 Klauen GO210-8/11,8</p>
<p><b>T57225</b></p> 	<p><b>Description:</b> NEEDLE BEARING (85X93X60)</p> <p><b>Packaging Unit:</b> 1</p> <p><b>OEM No :</b> 023 981 5210</p> <p><b>Model:</b> G140-8 G281-12 Klauen G330-12/11,64-0,78 GO240-8/6,57-0,63 GO250-8/6,57-0,63</p> <p><b>EX / CROSS :</b> 022 981 5410 022 981 5810 022 981 8510</p>
<p><b>T57231</b></p> 	<p><b>Description:</b> NEEDLE BEARING (85X93X73)</p> <p><b>Packaging Unit:</b> 1</p> <p><b>OEM No :</b> 022 981 5510</p> <p><b>Model:</b> G281-12 Klauen G330-12/11,64-0,78</p> <p><b>EX / CROSS :</b> 022 981 5910 024 981 2410</p>
<p><b>T49240</b></p> 	<p><b>Description:</b> NEEDLE BEARING (86X94X45)</p> <p><b>Packaging Unit:</b> 1</p> <p><b>OEM No :</b> 023 981 3810</p> <p><b>Model:</b> G71-6 G90-6 GO110-6/6,1-0,747</p> <p><b>EX / CROSS :</b> 018 981 9610 018 981 5810</p>





<p><b>T46608</b></p> 	<p><b>Description:</b> NEEDLE BEARING (89X97X40)</p> <p><b>OEM No :</b> 016 981 0010</p> <p><b>EX / CROSS :</b> F-219518 015 981 9810 018 981 8610 018 981 8710</p>	<p><b>Packaging Unit:</b> 1</p> <p><b>Model:</b> G181-9 G210-16/14,2-0,83 G221-9/10,19-1,00 G230-16/14,2-0,83 G240-16/11,72-0,69 G260-16/9,75-0,57</p>
<p><b>T58422</b></p> 	<p><b>Description:</b> NEEDLE BEARING (89X97X68)</p> <p><b>OEM No :</b> 021 981 1710</p> <p><b>EX / CROSS :</b> 019 981 9910 019 981 9810</p>	<p><b>Packaging Unit:</b> 1</p> <p><b>Model:</b> G181-9 G221-9/10,19-1,00</p>
<p><b>T54685</b></p> 	<p><b>Description:</b> NEEDLE BEARING (92X100X49,5)</p> <p><b>OEM No :</b> 019 981 3410</p> <p><b>EX / CROSS :</b> 018 981 7910 018 981 7410 018 981 0410 017 981 7910</p>	<p><b>Packaging Unit:</b> 1</p> <p><b>Model:</b> G100-12 G4/110-6/9,0 GO170-6/8,2-1,0 GO190-6/8,2-1,0 GO230-6/6,5-0,8 GO4/110-5/5,1 GO4/130-6/7,18 GO4/160-6/7,18 GO4/160-6/8,2 GV4/95-6/9,0</p>
<p><b>T11719</b></p> 	<p><b>Description:</b> NEEDLE ROLLER (Ø2,5X28,7)</p> <p><b>OEM No :</b> 615 981 0186</p> <p><b>EX / CROSS :</b></p>	<p><b>Packaging Unit:</b> 160</p> <p><b>Model:</b> HD 4/02 DG-10 HD 4/02 DG-10 BRAZIL HD 4/02 GD-10 HD 4/03 D-10 HD 4/03 D-10 BRAZIL HH 4/04 D-12 HH 4/05 D-10 BRAZIL HH 4/07 DL-10 BRAZIL HL 4/01 - 10 HL 4/01 D-10 HL 4/01 D-10 BRAZIL HL 4/01 DL-10 HL 4/01 DL-11,5 HL 4/01 L-10 HL 4/01-10 HL 4/035 D-10,6 HL 4/035 D-9,2 HL 4/038 D-10 HL 4/038 D-12 HL 4/038 D-9,4 HL 4/039 D-10 HL 4/039 D-12 HL 4/039 DL-12 HL 4/05 D-9,2</p>
<p><b>T12328</b></p> 	<p><b>Description:</b> NEEDLE ROLLER (Ø2X30)</p> <p><b>OEM No :</b> (395 981 0287/R)</p> <p><b>EX / CROSS :</b></p>	<p><b>Packaging Unit:</b> 156</p> <p><b>Model:</b></p>







<p><b>T51406</b></p> 	<p><b>Description:</b> NEEDLE ROLLER (Ø4X11,8)</p> <p><b>OEM No :</b> 355 981 0187</p> <p><b>EX / CROSS :</b> 000 981 1787</p> <p><b>Model:</b> HL 5/1 Z-10 HL 5/2 Z-10 HL 5/2 ZL-10 HL 5/2 ZS-10 HL 5/60 DZ-10 HO 5/4 Z-10 HO 5/8 DZ-10</p>	<p><b>Packaging Unit:</b> 1</p>
<p><b>T15267</b></p> 	<p><b>Description:</b> NEEDLE ROLLER (Ø4X31,5)</p> <p><b>OEM No :</b> (381 981 0087/R)</p> <p><b>EX / CROSS :</b></p>	<p><b>Packaging Unit:</b> 22</p>
<p><b>T15759</b></p> 	<p><b>Description:</b> NEEDLE ROLLER (Ø5X14,8)</p> <p><b>OEM No :</b> TAS77792</p> <p><b>EX / CROSS :</b> (001 981 2287/R)</p>	<p><b>Packaging Unit:</b> 1</p>
<p><b>T09033</b></p> 	<p><b>Description:</b> NEEDLE ROLLER (Ø5X19,6)</p> <p><b>OEM No :</b> 000 981 7987</p> <p><b>EX / CROSS :</b></p>	<p><b>Packaging Unit:</b> 50</p> <p><b>Model:</b> HD 7/014 DGS-16 TURKEY HD 7/016 DG-13 HD 7/016 DSG-13 HD 7/09 DG-10 HD 7/11 DG-9 HD 7/19 DG-13 HD 7/19 DGS-13 HD 7/19 DSG-13 HD 7/2 DG-10 HD 7/2 DLG-10 HD 7/2 DSG-10 HD 7/5 DG-10 HD 7/55 DCGS-13 HD 7/56 DGS-13 HL 7/013 D-16 HL 7/013 DS-16 TURKEY HL 7/015 D-13 TURKEY HL 7/015 DL-13 HL 7/015 DS-13 HL 7/02 DL-10 HL 7/021 D-10 HL 7/021 DL-10 HL 7/024 D-12,3 HL 7/024 DL-12,3</p>
<p><b>T19647</b></p> 	<p><b>Description:</b> NEEDLE ROLLER (Ø5X24,8)</p> <p><b>OEM No :</b> 001 981 5087</p> <p><b>EX / CROSS :</b></p>	<p><b>Packaging Unit:</b> 250</p> <p><b>Model:</b> HD 7/014 DG-16 HD 7/014 DGS-16 HD 7/014 DGS-16 TURKEY HD 7/016 DG-13 HD 7/016 DSG-13 HD 7/055 DCGS-13 HD 7/056 DGS-13 HD 7/056 DGS-16 HD 7/09 DG-10 HD 7/11 DG-9 HD 7/19 DG-13 HD 7/19 DG-13 TURKEY HD 7/19 DGS-13 HD 7/19 DGS-13 TURKEY HD 7/19 DSG-13 HD 7/2 DG-10 HD 7/2 DLG-10 HD 7/2 DSG-10 HD 7/5 DG-10 HL 7/013 D-16 HL 7/013 DS-16 TURKEY HL 7/015 D-13 HL 7/015 D-13 TURKEY HL 7/015 DL-13</p>





<p><b>T16893</b></p> 	<p><b>Description:</b> NEEDLE ROLLER (Ø5X28,8)</p> <p><b>OEM No :</b> 001 981 3287</p> <p><b>EX / CROSS :</b> 001 981 3187 001 981 3087</p>	<p><b>Packaging Unit:</b> 125</p> <p><b>Model:</b> G125-16/14,0 G135-16/11,9</p>
<p><b>T12303</b></p> 	<p><b>Description:</b> NEEDLE ROLLER (Ø5X36,8)</p> <p><b>OEM No :</b> 001 981 2787</p> <p><b>EX / CROSS :</b></p>	<p><b>Packaging Unit:</b> 125</p> <p><b>Model:</b> G155-16/11,9 G155-16/14,0 G155-9/15,9 G180-16/11,9 G180-16/14,0 GO210-8/11,8</p>
<p><b>T15153</b></p> 	<p><b>Description:</b> NEEDLE ROLLER (Ø5X39,8)</p> <p><b>OEM No :</b> 000 981 4186</p> <p><b>EX / CROSS :</b> 000 981 4386</p>	<p><b>Packaging Unit:</b> 125</p> <p><b>Model:</b> G155-16/11,9 G155-16/14,0 G155-9/15,9 G180-16/11,9 G180-16/14,0 G181-9 G200-16/11,9 G210-16/14,2-0,83 G211-12 Klauen G211-16/17,03-1,0 G221-9/10,19-1,00 G230-12 Klauen G230-16/14,2-0,83 G231-16/17,03-1,0 G240-16/11,72-0,69 G241-16 Klauen G260-16/9,75-0,57 G280-16 Klauen G281-12 Klauen G330-12/11,64-0,78 GO210-8/11,8</p>
<p><b>T14424</b></p> 	<p><b>Description:</b> NEEDLE ROLLER KIT</p> <p><b>OEM No :</b> 387 981 0187</p> <p><b>EX / CROSS :</b></p>	<p><b>Packaging Unit:</b> 1</p> <p><b>Model:</b> HD 7/014 DG-16 HD 7/014 DGS-16 TURKEY HD 7/016 DG-13 HD 7/016 DSG-13 HD 7/09 DG-10 HD 7/11 DG-9 HD 7/19 DG-13 HD 7/19 DGS-13 HD 7/19 DSG-13 HD 7/2 DG-10 HD 7/2 DLG-10 HD 7/2 DSG-10 HD 7/5 DG-10 HD 7/55 DCGS-13 HD 7/58 DGS-13 HL 7/013 D-16 HL 7/013 DS-16 TURKEY HL 7/015 D-13 HL 7/015 D-13 TURKEY HL 7/015 DL-13 HL 7/015 DS-13 HL 7/02 DL-10 HL 7/021 D-10 HL 7/021 DL-10</p>
<p><b>T11445</b></p> 	<p><b>Description:</b> NEEDLE ROLLER KIT</p> <p><b>OEM No :</b> 001 981 2287</p> <p><b>EX / CROSS :</b></p>	<p><b>Packaging Unit:</b> 1</p> <p><b>Model:</b> AL 7/1 D-7 AL 7/1 DS-7 AL 7/5 D-7 AL 7/8 D-8</p>



<p><b>T18693</b></p> 	<p><b>Description:</b> NEEDLE ROLLER KIT</p> <p><b>OEM No :</b> 395 981 0287</p> <p><b>EX / CROSS :</b></p>	<p><b>Packaging Unit:</b> 1</p> <p><b>Model:</b></p> <table border="0"> <tr><td>AL 7/1 D-7</td><td>HD 7/5 DG-10</td></tr> <tr><td>AL 7/1 DS-7</td><td>HL 7/1 D-10</td></tr> <tr><td>AL 7/5 D-7</td><td>HL 7/1 DL-10</td></tr> <tr><td>HD 7/11 DG-9</td><td>HL 7/1 L-10</td></tr> <tr><td>HD 7/19 DG-13</td><td>HL 7/1 S-10</td></tr> <tr><td>HD 7/19 DG-13 TURKEY</td><td>HL 7/1-10</td></tr> <tr><td>HD 7/19 DGS-13</td><td>HL 7/10 D-9</td></tr> <tr><td>HD 7/19 DGS-13 TURKEY</td><td>HL 7/18 D-13</td></tr> <tr><td>HD 7/19 DSG-13</td><td>HL 7/18 D-13 TURKEY</td></tr> <tr><td>HD 7/2 DG-10</td><td>HL 7/18 DS-13</td></tr> <tr><td>HD 7/2 DLG-10</td><td>HL 7/18 DS-13 TURKEY</td></tr> <tr><td>HD 7/2 DSG-10</td><td>HL 7/24 DS-9</td></tr> </table>	AL 7/1 D-7	HD 7/5 DG-10	AL 7/1 DS-7	HL 7/1 D-10	AL 7/5 D-7	HL 7/1 DL-10	HD 7/11 DG-9	HL 7/1 L-10	HD 7/19 DG-13	HL 7/1 S-10	HD 7/19 DG-13 TURKEY	HL 7/1-10	HD 7/19 DGS-13	HL 7/10 D-9	HD 7/19 DGS-13 TURKEY	HL 7/18 D-13	HD 7/19 DSG-13	HL 7/18 D-13 TURKEY	HD 7/2 DG-10	HL 7/18 DS-13	HD 7/2 DLG-10	HL 7/18 DS-13 TURKEY	HD 7/2 DSG-10	HL 7/24 DS-9
AL 7/1 D-7	HD 7/5 DG-10																									
AL 7/1 DS-7	HL 7/1 D-10																									
AL 7/5 D-7	HL 7/1 DL-10																									
HD 7/11 DG-9	HL 7/1 L-10																									
HD 7/19 DG-13	HL 7/1 S-10																									
HD 7/19 DG-13 TURKEY	HL 7/1-10																									
HD 7/19 DGS-13	HL 7/10 D-9																									
HD 7/19 DGS-13 TURKEY	HL 7/18 D-13																									
HD 7/19 DSG-13	HL 7/18 D-13 TURKEY																									
HD 7/2 DG-10	HL 7/18 DS-13																									
HD 7/2 DLG-10	HL 7/18 DS-13 TURKEY																									
HD 7/2 DSG-10	HL 7/24 DS-9																									
<p><b>T15266</b></p> 	<p><b>Description:</b> NEEDLE ROLLER KIT (22 PCS.)</p> <p><b>OEM No :</b> 381 981 0087</p> <p><b>EX / CROSS :</b> 000 981 8387 000 981 8487</p>	<p><b>Packaging Unit:</b> 1</p> <p><b>Model:</b></p> <table border="0"> <tr><td>G3/65-8/9,29</td></tr> <tr><td>G3/65-9/13,36</td></tr> <tr><td>G3/90-8/9,29</td></tr> <tr><td>UG100-8/9,57-0,7 GPA</td></tr> <tr><td>UNIMOOG</td></tr> <tr><td>UG3/40-8/13,01 UNIMOOG</td></tr> <tr><td>UG3/65-8/13,01 UNIMOOG</td></tr> </table>	G3/65-8/9,29	G3/65-9/13,36	G3/90-8/9,29	UG100-8/9,57-0,7 GPA	UNIMOOG	UG3/40-8/13,01 UNIMOOG	UG3/65-8/13,01 UNIMOOG																	
G3/65-8/9,29																										
G3/65-9/13,36																										
G3/90-8/9,29																										
UG100-8/9,57-0,7 GPA																										
UNIMOOG																										
UG3/40-8/13,01 UNIMOOG																										
UG3/65-8/13,01 UNIMOOG																										
<p><b>T63423</b></p> 	<p><b>Description:</b> NUT</p> <p><b>OEM No :</b> 389 325 2152</p> <p><b>EX / CROSS :</b></p>	<p><b>Packaging Unit:</b> 1</p> <p><b>Model:</b></p>																								
<p><b>T67131</b></p> 	<p><b>Description:</b> NUT</p> <p><b>OEM No :</b> 976 990 0150</p> <p><b>EX / CROSS :</b> 976 990 0050</p>	<p><b>Packaging Unit:</b> 1</p> <p><b>Model:</b> G100-12</p>																								
<p><b>T49965</b></p> 	<p><b>Description:</b> NUT (M30X1,5)</p> <p><b>OEM No :</b> 945 990 0250</p> <p><b>EX / CROSS :</b> 945 990 0150 945 990 0050</p>	<p><b>Packaging Unit:</b> 1</p> <p><b>Model:</b></p> <table border="0"> <tr><td>G210-16/14,2-0,83</td><td>GO170-6/8,2-1,0</td></tr> <tr><td>G211-12 Klauen</td><td>GO190-6/8,2-1,0</td></tr> <tr><td>G211-16/17,03-1,0</td><td>GO210-6/6,53-0,80</td></tr> <tr><td>G230-12 Klauen</td><td>GO230-6/6,5-0,8</td></tr> <tr><td>G230-16/14,2-0,83</td><td>GO240-8/6,57-0,63</td></tr> <tr><td>G231-16/17,03-1,0</td><td>GO250-8/6,57-0,63</td></tr> <tr><td>G240-16/11,72-0,69</td><td>GO4/160-6/8,2</td></tr> <tr><td>G241-16 Klauen</td><td></td></tr> <tr><td>G260-16/9,75-0,57</td><td></td></tr> <tr><td>G280-16 Klauen</td><td></td></tr> <tr><td>G281-12 Klauen</td><td></td></tr> <tr><td>G330-12/11,64-0,78</td><td></td></tr> </table>	G210-16/14,2-0,83	GO170-6/8,2-1,0	G211-12 Klauen	GO190-6/8,2-1,0	G211-16/17,03-1,0	GO210-6/6,53-0,80	G230-12 Klauen	GO230-6/6,5-0,8	G230-16/14,2-0,83	GO240-8/6,57-0,63	G231-16/17,03-1,0	GO250-8/6,57-0,63	G240-16/11,72-0,69	GO4/160-6/8,2	G241-16 Klauen		G260-16/9,75-0,57		G280-16 Klauen		G281-12 Klauen		G330-12/11,64-0,78	
G210-16/14,2-0,83	GO170-6/8,2-1,0																									
G211-12 Klauen	GO190-6/8,2-1,0																									
G211-16/17,03-1,0	GO210-6/6,53-0,80																									
G230-12 Klauen	GO230-6/6,5-0,8																									
G230-16/14,2-0,83	GO240-8/6,57-0,63																									
G231-16/17,03-1,0	GO250-8/6,57-0,63																									
G240-16/11,72-0,69	GO4/160-6/8,2																									
G241-16 Klauen																										
G260-16/9,75-0,57																										
G280-16 Klauen																										
G281-12 Klauen																										
G330-12/11,64-0,78																										

<p><b>T15465</b></p> 	<p><b>Description:</b> NUT (M40X1,5)</p> <p><b>OEM No :</b> 385 351 0172</p> <p><b>EX / CROSS :</b> 385 351 0072 327 353 0172</p>	<p><b>Packaging Unit:</b> 1</p> <p><b>Model:</b> AL 6/2 D-6 HD 4/02 DG-10 HD 4/02 DG-10 BRAZIL HD 4/02 GD-10 HD 4/021 GS-10 BRAZIL HD 4/03 D-10 HD 4/03 D-10 BRAZIL HD 4/21 DG-10 HD 4/21 G-10 HD 4/21 G-10 BRAZIL HD 4/22 D-10 HD 4/22 DG-10</p> <p>HD 4/22-10 HD 4/22-10 BRAZIL HD 6/3 D-10 HD 6/3 DG-10 HH 4/04 D-12 HH 4/05 D-10 BRAZIL HH 4/07 DL-10 BRAZIL HH 4/12 - 10 HH 4/12 D-10 HH 4/12 D-10 BRAZIL HH 4/12-10 HH 4/12-10 HH 4/19 D-10</p>
<p><b>T11231</b></p> 	<p><b>Description:</b> NUT (M55X1,5)</p> <p><b>OEM No :</b> 946 351 0072</p> <p><b>EX / CROSS :</b> 385 351 0572 346 353 0072</p>	<p><b>Packaging Unit:</b> 1</p> <p><b>Model:</b> HD 7/014 DG-16 HD 7/014 DGS-16 HD 7/014 DGS-16 TURKEY HD 7/016 DG-13 HD 7/016 DSG-13 HD 7/055 DCGS-13 HD 7/056 DGS-13 HD 7/056 DGS-16 HD 7/09 DG-10 HD 7/55 DCGS-13 HD 7/56 DGS-13 HL 6/1 DC(L,S)-13 (REINFORCED)</p> <p>HL 6/1 DC(LC)-13 (OLD VERSION) HL 6/1 DC(LC)-13 (REINFORCED) HL 6/3 DC(L,S)-13 (OLD VERSION) HL 7/013 D-16 HL 7/013 DS-16 TURKEY HL 7/015 D-13 HL 7/015 D-13 TURKEY HL 7/015 DL-13 HL 7/015 DS-13 HL 7/02 DL-10 HL 7/02 DL-10</p>
<p><b>T49931</b></p> 	<p><b>Description:</b> O RING (138X3)</p> <p><b>OEM No :</b> 028 997 2248</p> <p><b>EX / CROSS :</b> 019 997 7248</p>	<p><b>Packaging Unit:</b> 1</p> <p><b>Model:</b> G100-12 G200-16/11,9 G210-16/14,2-0,83 G211-12 Klauen G211-16/17,03-1,0 G230-12 Klauen G230-16/14,2-0,83 G231-16/17,03-1,0 G240-16/11,72-0,69 G241-16 Klauen G260-16/9,75-0,57 G280-16 Klauen</p> <p>G281-12 Klauen GO230-6/6,5-0,8 GO4/160-6/8,2</p>
<p><b>T64126</b></p> 	<p><b>Description:</b> O-RING (255X5)</p> <p><b>OEM No :</b> 027 997 2248</p> <p><b>EX / CROSS :</b> 016 997 4048 008 997 7545 002 997 4248 001 997 6848</p>	<p><b>Packaging Unit:</b> 1</p> <p><b>Model:</b> HD 7/014 DG-16 HD 7/014 DGS-16 HD 7/014 DGS-16 TURKEY HD 7/016 DG-13 HD 7/016 DSG-13 HD 7/055 DCGS-13 HD 7/056 DGS-13 HD 7/056 DGS-16 HD 7/09 DG-10 HD 7/11 DG-9 HD 7/19 DG-13 HD 7/19 DG-13 TURKEY</p> <p>HD 7/19 DGS-13 HD 7/19 DGS-13 TURKEY HD 7/19 DSG-13 HD 7/2 DG-10 HD 7/2 DLG-10 HD 7/2 DSG-10 HD 7/5 DG-10 HL 7/013 D-16 HL 7/013 DS-16 TURKEY HL 7/015 D-13 HL 7/015 D-13 TURKEY HL 7/015 DL-13</p>
<p><b>T76483</b></p> 	<p><b>Description:</b> O-RING (34X3)</p> <p><b>OEM No :</b> 023 997 1048</p> <p><b>EX / CROSS :</b> 023 997 7748 022 997 7748</p>	<p><b>Packaging Unit:</b> 10</p> <p><b>Model:</b></p>



T70478



**Description:**

O-RINGS AND OIL SEALS KIT G240-16

**Packaging Unit:** 1

**OEM No :**

TAS70478

**Model:**

G240-16/11,72-0,69

**EX / CROSS :**

T63509



**Description:**

O-RINGS KIT G221-9

**Packaging Unit:** 1

**OEM No :**

TAS63509

**Model:**

G221-9/10,19-1,00

**EX / CROSS :**

T63508

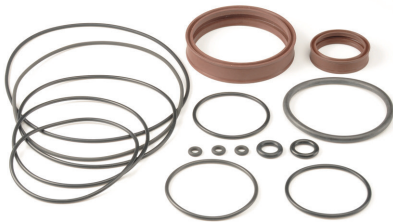

**Description:**

O-RINGS KIT G240-16

**Packaging Unit:** 1

**OEM No :**

TAS63508

**Model:**

G240-16/11,72-0,69

**EX / CROSS :**

T60937



**Description:**

OIL COLLECTOR

**Packaging Unit:** 1

**OEM No :**

944 353 0328

**Model:**

HD 7/55 DCGS-13  
HD 7/56 DGS-13  
HL 7/233  
HL 7/55 DCS-13  
HL 7/56 DS-13

**EX / CROSS :**

T45739



**Description:**

OIL COLLECTOR

**Packaging Unit:** 1

**OEM No :**





942 353 0428



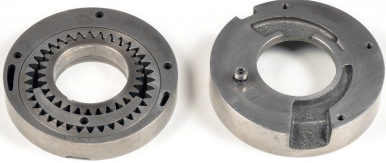

**Model:**

HD 7/055 DCGS-13  
HD 7/056 DGS-13  
HD 7/056 DGS-16  
HL 7/055 DCS-13





**EX / CROSS :**



<p><b>T49970</b></p> 	<p><b>Description:</b> OIL COLLECTOR (75X16)</p> <p><b>OEM No :</b> 389 261 0665</p> <p><b>EX / CROSS :</b> 389 262 9454 389 261 0765</p>	<p><b>Packaging Unit:</b> 1</p> <p><b>Model:</b></p>
<p><b>T11134</b></p> 	<p><b>Description:</b> OIL PUMP</p> <p><b>OEM No :</b> 385 260 0390</p> <p><b>EX / CROSS :</b></p>	<p><b>Packaging Unit:</b> 1</p> <p><b>Model:</b> G3/65-8/9,29 G3/65-9/13,36 G3/90-8/9,29</p>
<p><b>T11135</b></p> 	<p><b>Description:</b> OIL PUMP ASSY</p> <p><b>OEM No :</b> 389 260 0690</p> <p><b>EX / CROSS :</b> 389 260 0590 389 260 0490</p>	<p><b>Packaging Unit:</b> 1</p> <p><b>Model:</b> G125-16/14,0 G135-16/11,9 G155-16/11,9 G155-16/14,0 G155-9/15,9 G180-16/11,9 G180-16/14,0 G181-9 G200-16/11,9 G210-16/14,2-0,83 G211-16/17,03-1,0 G221-9/10,19-1,00 G230-16/14,2-0,83 G231-16/17,03-1,0 G240-16/11,72-0,69 G260-16/9,75-0,57 G330-12/11,64-0,78 GO210-8/11,8</p>
<p><b>T53152</b></p> 	<p><b>Description:</b> OIL PUMP BODY</p> <p><b>OEM No :</b> 656 269 0001</p> <p><b>EX / CROSS :</b> 629 269 0001</p>	<p><b>Packaging Unit:</b> 1</p> <p><b>Model:</b> GO210-6/6,53-0,80 GO230-6/6,5-0,8 GO240-8/6,57-0,63 GO250-8/6,57-0,63</p>
<p><b>T38524</b></p> 	<p><b>Description:</b> OIL PUMP BODY</p> <p><b>OEM No :</b> 947 269 1001</p> <p><b>EX / CROSS :</b> 947 269 0501 389 269 3801</p>	<p><b>Packaging Unit:</b> 1</p> <p><b>Model:</b> G125-16/14,0 G131-9 G135-16/11,9 G141-9 G155-16/11,9 G155-16/14,0 G155-9/15,9 G180-16/11,9 G180-16/14,0 G181-9 G200-16/11,9 G210-16/14,2-0,83 G211-12 Klauen G211-16/17,03-1,0 G221-9/10,19-1,00 G230-12 Klauen G230-16/14,2-0,83 G231-16/17,03-1,0 G240-16/11,72-0,69 G241-16 Klauen G260-16/9,75-0,57 G280-16 Klauen G281-12 Klauen G330-12/11,64-0,78</p>



<p><b>T56724</b></p> 	<p><b>Description:</b> OIL PUMP BODY</p> <p><b>OEM No :</b> 389 269 2101</p> <p><b>EX / CROSS :</b> 389 269 2201</p> <p><b>Model:</b> G100-12 GO4/160-6/8,2</p>	<p><b>Packaging Unit:</b> 1</p>
<p><b>T38525</b></p> 	<p><b>Description:</b> OIL PUMP COVER</p> <p><b>OEM No :</b> 945 269 0201</p> <p><b>EX / CROSS :</b> 945 269 0101</p>	<p><b>Packaging Unit:</b> 1</p> <p><b>Model:</b> G125-16/14,0 G131-9 G135-16/11,9 G141-9 G155-16/11,9 G155-16/14,0 G155-9/15,9 G180-16/11,9 G180-16/14,0 G181-9 G200-16/11,9 G210-16/14,2-0,83</p> <p>G211-12 Klauen G211-16/17,03-1,0 G221-9/10,19-1,00 G230-12 Klauen G230-16/14,2-0,83 G231-16/17,03-1,0 G240-16/11,72-0,69 G241-16 Klauen G260-16/9,75-0,57 G280-16 Klauen G281-12 Klauen G330-12/11,64-0,78</p>
<p><b>T53149</b></p> 	<p><b>Description:</b> OIL PUMP COVER</p> <p><b>OEM No :</b> 389 269 2001</p> <p><b>EX / CROSS :</b> 389 269 1901</p>	<p><b>Packaging Unit:</b> 1</p> <p><b>Model:</b> G100-12 GO170-6/8,2-1,0 GO190-6/8,2-1,0 GO210-6/6,53-0,80 GO230-6/6,5-0,8 GO240-8/6,57-0,63 GO250-8/6,57-0,63 GO4/160-6/8,2</p>
<p><b>T39053</b></p> 	<p><b>Description:</b> OIL PUMP DRIVE GEAR SMALL (INTERNAL)</p> <p><b>OEM No :</b> 389 269 1506</p> <p><b>EX / CROSS :</b> 389 269 1406 389 260 0790</p>	<p><b>Packaging Unit:</b> 1</p> <p><b>Model:</b> G125-16/14,0 G131-9 G135-16/11,9 G141-9 G155-16/11,9 G155-16/14,0 G155-9/15,9 G180-16/11,9 G180-16/14,0 G181-9 G200-16/11,9 G210-16/14,2-0,83</p> <p>G211-12 Klauen G211-16/17,03-1,0 G221-9/10,19-1,00 G230-12 Klauen G230-16/14,2-0,83 G231-16/17,03-1,0 G240-16/11,72-0,69 G241-16 Klauen G260-16/9,75-0,57 G280-16 Klauen G281-12 Klauen G330-12/11,64-0,78</p>
<p><b>T53154</b></p> 	<p><b>Description:</b> OIL PUMP DRIVE GEAR SMALL (INTERNAL) (9T.)</p> <p><b>OEM No :</b> 389 269 1606</p> <p><b>EX / CROSS :</b> 389 269 1706</p>	<p><b>Packaging Unit:</b> 1</p> <p><b>Model:</b> G100-12 G140-8 GO170-6/8,2-1,0 GO190-6/8,2-1,0 GO210-6/6,53-0,80 GO230-6/6,5-0,8 GO240-8/6,57-0,63 GO250-8/6,57-0,63 GO4/160-6/8,2</p>

<p><b>T39052</b></p> 	<p><b>Description:</b> OIL PUMP DRIVEN GEAR BIG (EXTERNAL)</p> <p><b>Packaging Unit:</b> 1</p> <p><b>OEM No :</b> 389 269 1206</p> <p><b>EX / CROSS :</b> 389 269 0706</p> <p><b>Model:</b> G100-12 G125-16/14,0 G131-9 G135-16/11,9 G140-8 G141-9 G155-16/11,9 G155-16/14,0 G155-9/15,9 G180-16/11,9 G180-16/14,0 G181-9 G200-16/11,9 G210-16/14,2-0,83 G211-12 Klauen G211-16/17,03-1,0 G230-12 Klauen G230-16/14,2-0,83 G231-16/17,03-1,0 G241-16 Klauen G260-16/9,75-0,57 G280-16 Klauen G281-12 Klauen GO170-6/8,2-1,0</p>
<p><b>T60251</b></p> 	<p><b>Description:</b> OIL PUMP SHAFT</p> <p><b>Packaging Unit:</b> 1</p> <p><b>OEM No :</b> 389 269 1310</p> <p><b>EX / CROSS :</b> 389 269 0810</p> <p><b>Model:</b> G211-16/17,03-1,0 G221-9/10,19-1,00 G231-16/17,03-1,0 G260-16/9,75-0,57</p>
<p><b>T77457</b></p> 	<p><b>Description:</b> OIL SEAL KIT VOITH RETARDER VR115 HV FOR ACTROS</p> <p><b>Packaging Unit:</b> 1</p> <p><b>OEM No :</b> 1530 0420 610</p> <p><b>EX / CROSS :</b> 000 430 3895 000 430 5495</p> <p><b>Model:</b></p>
<p><b>T77180</b></p> 	<p><b>Description:</b> OIL SEAL RING</p> <p><b>Packaging Unit:</b> 1</p> <p><b>OEM No :</b> 010 997 6046</p> <p><b>EX / CROSS :</b></p> <p><b>Model:</b> G3/90-8/9,29</p>
<p><b>T77183</b></p> 	<p><b>Description:</b> OIL SEAL RING</p> <p><b>Packaging Unit:</b> 1</p> <p><b>OEM No :</b> 010 997 6246</p> <p><b>EX / CROSS :</b></p> <p><b>Model:</b></p>

<p><b>T65126</b></p> 	<p><b>Description:</b> OIL SEAL RING (143X165X8,5/9,5)</p> <p><b>Packaging Unit:</b> 1</p> <p><b>OEM No :</b> 011 997 3746</p> <p><b>EX / CROSS :</b></p> <p><b>Model:</b> G125-16/14,0 G135-16/11,9 G155-16/11,9 G155-16/14,0 G155-9/15,9 G180-16/11,9 G200-16/11,9 G210-16/14,2-0,83 G230-16/14,2-0,83 G240-16/11,72-0,69 G3/50-5/8,5 G3/60-5/5,4</p> <p>G3/61-5/6,1 G3/61-5/6,1 Brazil G3/65-8/9,29 G3/90-8/9,29 G4/110-6/9,0 G4/65-6/9,0 G4/65-7/11,0 G4/95-6/9,0 G4/95-7/11,0 G60-6/9,20-1,00 G04/105-6/7,18 GV4/110-6/9,0</p>
<p><b>T82143</b></p> 	<p><b>Description:</b> OIL SEAL RING (145X175X13/12)</p> <p><b>Packaging Unit:</b> 1</p> <p><b>OEM No :</b> 013 997 9447</p> <p><b>EX / CROSS :</b> 013 997 9347 013 997 6547 020 997 3947</p> <p><b>Model:</b> HD 7/014 DG-16 HD 7/014 DGS-16 HD 7/014 DGS-16 TURKEY HD 7/016 DG-13 HD 7/016 DSG-13 HD 7/056 DCGS-13 HD 7/056 DGS-13 HD 7/056 DGS-16 HD 7/09 DG-10 HD 7/11 DG-9 HD 7/19 DG-13 HD 7/19 DG-13 TURKEY</p> <p>HD 7/19 DGS-13 HD 7/19 DGS-13 TURKEY HD 7/19 DSG-13 HD 7/2 DLG-10 HD 7/2 DLG-10 HD 7/2 DSG-10 HD 7/5 DG-10 HD 7/55 DCGS-13 HD 7/58 DGS-13 HL 7/013 D-16 HL 7/013 DS-16 TURKEY HL 7/015 D-13</p>
<p><b>T22837</b></p> 	<p><b>Description:</b> OIL SEAL RING (22X32X5/8)</p> <p><b>Packaging Unit:</b> 10</p> <p><b>OEM No :</b> 000 267 0197</p> <p><b>EX / CROSS :</b> 000 267 0397</p> <p><b>Model:</b> G100-12 G125-16/14,0 G135-16/11,9 G140-8 G141-9 G155-16/11,9 G155-16/14,0 G155-9/15,9 G180-16/11,9 G180-16/14,0 G200-16/11,9 G210-16/14,2-0,83</p> <p>G211-12 Klauen G211-16/17,03-1,0 G221-9/10,19-1,00 G230-12 Klauen G230-16/14,2-0,83 G231-16/17,03-1,0 G240-16/11,72-0,69 G241-16 Klauen G260-16/9,75-0,57 G280-16 Klauen G281-12 Klauen G330-12/11,64-0,78</p>
<p><b>T49953</b></p> 	<p><b>Description:</b> OIL SEAL RING (38X28)</p> <p><b>Packaging Unit:</b> 1</p> <p><b>OEM No :</b> 017 997 1847</p> <p><b>EX / CROSS :</b></p> <p><b>Model:</b> G125-16/14,0 G135-16/11,9 G155-16/11,9 G155-16/14,0 G155-9/15,9 G180-16/11,9 G200-16/11,9 G210-16/14,2-0,83 G240-16/11,72-0,69 GV4/110-6/9,0 GV4/95-6/9,0</p>
<p><b>T22839</b></p> 	<p><b>Description:</b> OIL SEAL RING (41X48X11,5)</p> <p><b>Packaging Unit:</b> 5</p> <p><b>OEM No :</b> 006 997 6447</p> <p><b>EX / CROSS :</b> 020 997 6647 012 997 3347</p> <p><b>Model:</b> G100-12 G125-16/14,0 G135-16/11,9 G140-8 G155-16/11,9 G155-16/14,0 G180-16/11,9 G180-16/14,0 G200-16/11,9 G210-16/14,2-0,83 G211-12 Klauen G211-16/17,03-1,0</p> <p>G230-12 Klauen G230-16/14,2-0,83 G231-16/17,03-1,0 G240-16/11,72-0,69 G241-16 Klauen G260-16/9,75-0,57 G280-16 Klauen G281-12 Klauen G330-12/11,64-0,78 GV4/110-6/9,0 GV4/65-6/9,0 GV4/95-6/9,0</p>









<p><b>T45221</b></p> 	<p><b>Description:</b> OIL SEAL RING (55X80X8)</p> <p><b>OEM No :</b> 013 997 2646</p> <p><b>EX / CROSS :</b> 021 997 1747 021 997 2547</p>	<p><b>Packaging Unit:</b> 1</p> <p><b>Model:</b> G60-6/9,20-1,00 G71-6 G85-6/6,70-0,83 G90-6 GO110-6/6,1-0,747</p>
<p><b>T22850</b></p> 	<p><b>Description:</b> OIL SEAL RING (56X72X8)</p> <p><b>OEM No :</b> 019 997 0547</p> <p><b>EX / CROSS :</b> 023 997 7847 019 997 0347</p>	<p><b>Packaging Unit:</b> 1</p> <p><b>Model:</b> G131-9 G140-8 G141-9 G181-9 G210-16/14,2-0,83 G211-12 Klauen G211-16/17,03-1,0 G221-9/10,19-1,00 G230-12 Klauen G230-16/14,2-0,83 G231-16/17,03-1,0 G240-16/11,72-0,69 G241-16 Klauen G260-16/9,75-0,57 G280-16 Klauen G281-12 Klauen G330-12/11,64-0,78 GO170-6/8,2-1,0 GO190-6/8,2-1,0 GO210-6/6,53-0,80 GO230-6/6,5-0,8 GO240-8/6,57-0,63 GO250-8/6,57-0,63</p>
<p><b>T45225</b></p> 	<p><b>Description:</b> OIL SEAL RING (70X88X10)</p> <p><b>OEM No :</b> 024 997 3247</p> <p><b>EX / CROSS :</b> 024 997 2747 020 997 7247</p>	<p><b>Packaging Unit:</b> 1</p> <p><b>Model:</b> G60-6/9,20-1,00 G71-6 G85-6/6,70-0,83 G90-6 GO110-6/6,1-0,747</p>
<p><b>T83369</b></p> 	<p><b>Description:</b> OIL SEAL RING (72X105X13)</p> <p><b>OEM No :</b> 013 997 4947</p> <p><b>EX / CROSS :</b> 011 997 6847 010 997 5346 010 997 3746</p>	<p><b>Packaging Unit:</b> 1</p> <p><b>Model:</b> HL 7/1 D-10 HL 7/1 DL-10 HL 7/1 L-10 HL 7/1 S-10 HL 7/1-10 HL 7/10 D-9 HL 7/18 D-13 HL 7/18 DS-13 HL 7/24 DS-9 HL 7/3 D-10 HL 7/3 DL-10 HL 7/4 D-10 HO 7/10 DL-11,5 HO 7/8 DL-10 HO 7/9 DL-10</p>
<p><b>T38574</b></p> 	<p><b>Description:</b> OIL SEAL RING (72X105X19)</p> <p><b>OEM No :</b> 020 997 0647</p> <p><b>EX / CROSS :</b> 011 997 7047 009 997 9146</p>	<p><b>Packaging Unit:</b> 1</p> <p><b>Model:</b> AL 7/1 D-7 AL 7/1 DS-7 AL 7/5 D-7 AL 7/8 D-8 HL 7/1 D-10 HL 7/1 DL-10 HL 7/1 L-10 HL 7/1 S-10 HL 7/1-10 HL 7/10 D-9 HL 7/18 D-13 HL 7/18 D-13 TURKEY HL 7/18 DS-13 HL 7/233 HL 7/24 DS-9 HL 7/26 D-11,5 HL 7/26 D-12,3 HL 7/26 DL-12,3 HL 7/3 D-10 HL 7/3 DL-10 HL 7/3 DS-10 HL 7/4 D-10 HL 7/55 DCS-13</p>

<p><b>T22829</b></p> 	<p><b>Description:</b> OIL SEAL RING (73,5X101X7)</p> <p><b>OEM No :</b> 000 262 8662</p> <p><b>EX / CROSS :</b> 000 262 9062</p>	<p><b>Packaging Unit:</b> 1</p> <p><b>Model:</b> G211-12 Klauen G211-16/17,03-1,0 G230-12 Klauen G231-16/17,03-1,0 G241-16 Klauen G260-16/9,75-0,57 G280-16 Klauen G281-12 Klauen G330-12/11,64-0,78</p>
<p><b>T52380</b></p> 	<p><b>Description:</b> OIL SEAL RING (75X94X11,5)</p> <p><b>OEM No :</b> 017 997 9947</p> <p><b>EX / CROSS :</b> 018 997 4947 018 997 7347</p>	<p><b>Packaging Unit:</b> 1</p> <p><b>Model:</b> G181-9 G221-9/10,19-1,00 GO170-6/8,2-1,0 GO190-6/8,2-1,0 GO210-6/6,53-0,80 GO230-6/6,5-0,8 GO4/160-6/8,2</p>
<p><b>T19636</b></p> 	<p><b>Description:</b> OIL SEAL RING (75X95X10/9,5)</p> <p><b>OEM No :</b> 017 997 3047</p> <p><b>EX / CROSS :</b></p>	<p><b>Packaging Unit:</b> 1</p> <p><b>Model:</b> HD 6/3 D-10 HD 6/3 DG-10 HD 7/014 DG-16 HD 7/014 DGS-16 HD 7/014 DGS-16 TURKEY HD 7/016 DG-13 HD 7/016 DSG-13 HD 7/055 DCGS-13 HD 7/056 DGS-13 HD 7/056 DGS-16 HD 7/09 DG-10 HD 7/55 DCGS-13</p> <p>HD 7/56 DGS-13 HL O/3-3,3</p>
<p><b>T38346</b></p> 	<p><b>Description:</b> OIL SEAL RING (75X95X10/9,5)</p> <p><b>OEM No :</b> 017 997 8147</p> <p><b>EX / CROSS :</b> 017 997 3147 014 997 4346 009 997 1446 007 997 5147</p>	<p><b>Packaging Unit:</b> 1</p> <p><b>Model:</b> HD 7/014 DG-16 HD 7/014 DGS-16 HD 7/014 DGS-16 TURKEY HD 7/016 DG-13 HD 7/016 DSG-13 HD 7/055 DCGS-13 HD 7/056 DGS-13 HD 7/056 DGS-16 HD 7/09 DG-10 HD 7/55 DCGS-13 HD 7/56 DGS-13</p>
<p><b>T22833</b></p> 	<p><b>Description:</b> OIL SEAL RING (78,5X105X7)</p> <p><b>OEM No :</b> 000 262 8762</p> <p><b>EX / CROSS :</b> 019 997 2147 000 262 9162</p>	<p><b>Packaging Unit:</b> 5</p> <p><b>Model:</b> G210-16/14,2-0,83 G211-16/17,03-1,0 G230-16/14,2-0,83 G231-16/17,03-1,0 G240-16/11,72-0,69 G260-16/9,75-0,57 GO240-8/6,57-0,63 GO250-8/6,57-0,63</p>

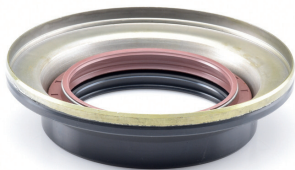

<p><b>T56494</b></p> 	<p><b>Description:</b> OIL SEAL RING (80X100X15,5)</p> <p><b>OEM No :</b> 023 997 8847</p> <p><b>EX / CROSS :</b> 023 997 8547 020 997 6447 007 997 8446</p>	<p><b>Packaging Unit:</b> 1</p> <p><b>Model:</b> G100-12 G140-8 G141-9 GO230-6/6,5-0,8 GO240-8/6,57-0,63</p>
<p><b>T63630</b></p> 	<p><b>Description:</b> OIL SEAL RING (80X105X10)</p> <p><b>OEM No :</b> 018 997 7147</p> <p><b>EX / CROSS :</b></p>	<p><b>Packaging Unit:</b> 1</p> <p><b>Model:</b> G155-16/11,9 G155-16/14,0 G180-16/11,9 G180-16/14,0 G200-16/11,9 G210-16/14,2-0,83</p>
<p><b>T22848</b></p> 	<p><b>Description:</b> OIL SEAL RING (80X90X17)</p> <p><b>OEM No :</b> 024 997 8347</p> <p><b>EX / CROSS :</b> 020 997 6747 014 997 3647</p>	<p><b>Packaging Unit:</b> 5</p> <p><b>Model:</b> G125-16/14,0 G131-9 G135-16/11,9 G141-9 G155-16/11,9 G155-16/14,0 G155-9/15,9 G180-16/11,9 G180-16/14,0 G181-9 G200-16/11,9 G210-16/14,2-0,83 G211-12 Klauen G211-16/17,03-1,0 G221-9/10,19-1,00 G230-12 Klauen G230-16/14,2-0,83 G231-16/17,03-1,0 G240-16/11,72-0,69 G241-16 Klauen G260-16/9,75-0,57 G280-16 Klauen G281-12 Klauen G330-12/11,64-0,78</p>
<p><b>T82146</b></p> 	<p><b>Description:</b> OIL SEAL RING (85X105X13/9,5)</p> <p><b>OEM No :</b> 017 997 2847</p> <p><b>EX / CROSS :</b></p>	<p><b>Packaging Unit:</b> 5</p> <p><b>Model:</b> HD 7/014 DG-16 HD 7/014 DGS-16 HD 7/016 DG-13 HD 7/016 DSG-13 HD 7/09 DG-10</p>
<p><b>T19718</b></p> 	<p><b>Description:</b> OIL SEAL RING (85X110X12/17)</p> <p><b>OEM No :</b> 014 997 1246</p> <p><b>EX / CROSS :</b></p>	<p><b>Packaging Unit:</b> 1</p> <p><b>Model:</b> HD 7/055 DCGS-13 HD 7/056 DGS-13 HD 7/056 DGS-16 HD 7/55 DCGS-13 HD 7/56 DGS-13</p>



<p><b>T64524</b></p> 	<p><b>Description:</b> OIL SEAL RING (85X120X21)</p> <p><b>OEM No :</b> 942 353 0159</p> <p><b>EX / CROSS :</b></p>	<p><b>Packaging Unit:</b> 1</p> <p><b>Model:</b> HD 7/055 DCGS-13 HD 7/056 DGS-13 HD 7/056 DGS-16 HD 7/55 DCGS-13 HD 7/56 DGS-13</p>
<p><b>T18586</b></p> 	<p><b>Description:</b> OIL SEAL RING (85X145X37)</p> <p><b>OEM No :</b> 015 997 4747</p> <p><b>EX / CROSS :</b></p>	<p><b>Packaging Unit:</b> 1</p> <p><b>Model:</b></p>
<p><b>T58426</b></p> 	<p><b>Description:</b> OIL SEAL RING (85X68X10)</p> <p><b>OEM No :</b> 016 997 6747</p> <p><b>EX / CROSS :</b></p>	<p><b>Packaging Unit:</b> 1</p> <p><b>Model:</b> HD 4/02 DG-10 HD 4/03 D-10 HH 4/04 D-12 HH 4/12 D-10 HH 4/12 D-10 BRAZIL HL 4/01 - 10 HL 4/01 D-10 HL 4/01 D-10 BRAZIL HL 4/01 DL-10 HL 4/01 DL-11,5 HL 4/01 L-10 HL 4/01-10 HL 4/05 D-9,2 HL 4/06 D-12 HL 4/06 DL-12 HL 4/07 D-9,4 HL 4/08 D-10,6 HL 4/09 D-9,2 HL 4/12 D-10 BRAZIL HL 4/25 D-7,6 BRAZIL HL 4/25-7,6 BRAZIL HL 4/26 D-9,2 BRAZIL HL 4/27 D-10 BRAZIL HL 4/60 D-10</p>
<p><b>T56480</b></p> 	<p><b>Description:</b> OIL SEAL RING (85X68X10)</p> <p><b>OEM No :</b> 018 997 5147</p> <p><b>EX / CROSS :</b> 016 997 6647 005 997 7647 005 997 6947 005 997 6747</p>	<p><b>Packaging Unit:</b> 1</p> <p><b>Model:</b> HD 4/02 DG-10 HD 4/03 D-10 HD 4/03 D-10 BRAZIL HH 4/04 D-12 HH 4/05 D-10 BRAZIL HH 4/07 DL-10 BRAZIL HH 4/12 D-10 HH 4/12 D-10 BRAZIL HL 4/01 - 10 HL 4/01 D-10 HL 4/01 D-10 BRAZIL HL 4/01 DL-10 HL 4/01 L-10 HL 4/01-10 HL 4/01 L-10 HL 4/01-10 HL 4/05 D-9,2 HL 4/06 D-12 HL 4/06 DL-12 HL 4/07 D-9,4 HL 4/08 D-10,6 HL 4/09 D-9,2 HL 4/12 D-10 BRAZIL HL 4/25 D-7,6 BRAZIL HL 4/25-7,6 BRAZIL HL 4/26 D-9,2 BRAZIL</p>
<p><b>T67200</b></p> 	<p><b>Description:</b> OIL SEAL RING (86X100X14/18)</p> <p><b>OEM No :</b> 015 997 7746</p> <p><b>EX / CROSS :</b></p>	<p><b>Packaging Unit:</b> 1</p> <p><b>Model:</b> G211-12 Klauen G230-12 Klauen</p>









<p><b>T22716</b></p> 	<p><b>Description:</b> OIL SEAL RING (90X110X15,5)</p> <p><b>OEM No :</b> 015 997 6947</p> <p><b>EX / CROSS :</b></p>	<p><b>Packaging Unit:</b> 1</p> <p><b>Model:</b></p>
<p><b>T38573</b></p> 	<p><b>Description:</b> OIL SEAL RING (90X68X10)</p> <p><b>OEM No :</b> 017 997 2747</p> <p><b>EX / CROSS :</b> 009 997 0446 007 997 5047 007 997 3947</p>	<p><b>Packaging Unit:</b> 1</p> <p><b>Model:</b> HD 4/02 DG-10 HD 4/02 DG-10 BRAZIL HD 4/02 GD-10 HD 4/021 GS-10 BRAZIL HD 4/21 DG-10 HD 4/21 G-10 HD 4/21 G-10 BRAZIL HD 4/22-10 HD 7/11 DG-9 HD 7/19 DG-13 HD 7/19 DG-13 TURKEY HD 7/19 DGS-13 HD 7/19 DSG-13 HD 7/2 DG-10 HD 7/2 DLG-10 HD 7/2 DSG-10 HD 7/5 DG-10 HD 7/19 DGS-13 TURKEY</p>
<p><b>T38572</b></p> 	<p><b>Description:</b> OIL SEAL RING (90X68X10)</p> <p><b>OEM No :</b> 017 997 2647</p> <p><b>EX / CROSS :</b></p>	<p><b>Packaging Unit:</b> 1</p> <p><b>Model:</b> HD 4/02 DG-10 HD 4/02 DG-10 BRAZIL HD 4/02 GD-10 HD 4/021 GS-10 BRAZIL HD 4/21 DG-10 HD 4/21 G-10 HD 4/21 G-10 BRAZIL HD 4/22-10 HD 7/11 DG-9 HD 7/19 DG-13 HD 7/19 DG-13 TURKEY HD 7/19 DGS-13 HD 7/19 DSG-13 HD 7/2 DG-10 HD 7/2 DLG-10 HD 7/2 DSG-10 HD 7/5 DG-10 HD 7/19 DGS-13 TURKEY</p>
<p><b>T22842</b></p> 	<p><b>Description:</b> OIL SEAL RING (95X115X13)</p> <p><b>OEM No :</b> 013 997 7247</p> <p><b>EX / CROSS :</b> 014 997 1947 013 997 5547</p>	<p><b>Packaging Unit:</b> 1</p> <p><b>Model:</b> G125-16/14,0 G135-16/11,9 G155-16/11,9 G155-16/14,0 G155-9/15,9 G180-16/11,9 G180-16/14,0 G200-16/11,9 G210-16/14,2-0,83 G211-16/17,03-1,0 G221-9/10,19-1,00 G230-16/14,2-0,83 G231-16/17,03-1,0 G240-16/11,72-0,69 G241-16 Klauen G260-16/9,75-0,57 G280-16 Klauen GO210-8/11,8</p>
<p><b>T56493</b></p> 	<p><b>Description:</b> OIL SEAL RING (95X115X13)</p> <p><b>OEM No :</b> 020 997 9947</p> <p><b>EX / CROSS :</b> 021 997 0047 007 997 3847 009 997 0646 008 997 0347</p>	<p><b>Packaging Unit:</b> 1</p> <p><b>Model:</b> GO210-6/6,53-0,80</p>

<p><b>T22845</b></p> 	<p><b>Description:</b> OIL SEAL RING (95X115X13/12)</p> <p><b>OEM No :</b> 013 997 7347</p> <p><b>EX / CROSS :</b> 015 997 4247 013 997 5647</p>	<p><b>Packaging Unit:</b> 1</p> <p><b>Model:</b> G125-16/14,0 G135-16/11,9 G155-16/11,9 G155-16/14,0 G155-9/15,9 G180-16/11,9 G180-16/14,0 G181-9 G200-16/11,9 G210-16/14,2-0,83 G211-16/17,03-1,0 G221-9/10,19-1,00 G230-16/14,2-0,83 G231-16/17,03-1,0 G240-16/11,72-0,69 G241-16 Klauen G260-16/9,75-0,57 G280-16 Klauen GQ210-8/11,8</p>
<p><b>T43835</b></p> 	<p><b>Description:</b> OIL SEAL RING (95X115X15,5)</p> <p><b>OEM No :</b> 023 997 1647</p> <p><b>EX / CROSS :</b> 015 997 7846</p>	<p><b>Packaging Unit:</b> 1</p> <p><b>Model:</b> G181-9 G211-16/17,03-1,0 G230-16/14,2-0,83 G231-16/17,03-1,0 G241-16 Klauen G260-16/9,75-0,57 G280-16 Klauen G281-12 Klauen G330-12/11,64-0,78</p>
<p><b>T63510</b></p> 	<p><b>Description:</b> OIL SEALS KIT G221-9</p> <p><b>OEM No :</b> TAS63510</p> <p><b>EX / CROSS :</b></p>	<p><b>Packaging Unit:</b> 1</p> <p><b>Model:</b> G221-9/10,19-1,00</p>
<p><b>T63507</b></p> 	<p><b>Description:</b> OIL SEALS KIT G240-16</p> <p><b>OEM No :</b> TAS63507</p> <p><b>EX / CROSS :</b></p>	<p><b>Packaging Unit:</b> 1</p> <p><b>Model:</b> G240-16/11,72-0,69</p>
<p><b>T50076</b></p> 	<p><b>Description:</b> OIL TUBE</p> <p><b>OEM No :</b> 945 269 0834</p> <p><b>EX / CROSS :</b> 389 269 4734</p>	<p><b>Packaging Unit:</b> 1</p> <p><b>Model:</b> G131-9 G141-9 G181-9 G210-16/14,2-0,83 G211-16/17,03-1,0 G221-9/10,19-1,00 G230-16/14,2-0,83 G231-16/17,03-1,0 G240-16/11,72-0,69 G241-16 Klauen G260-16/9,75-0,57 G280-16 Klauen G281-12 Klauen G330-12/11,64-0,78</p>







<p><b>T39690</b></p> 	<p><b>Description:</b> OIL TUBE</p> <p><b>OEM No :</b> 389 269 8534</p> <p><b>EX / CROSS :</b></p>	<p><b>Packaging Unit:</b> 1</p> <p><b>Model:</b> G210-16/14,2-0,83 G230-16/14,2-0,83 G240-16/11,72-0,69</p>
<p><b>T67217</b></p> 	<p><b>Description:</b> OIL TUBE</p> <p><b>OEM No :</b> 389 269 0134</p> <p><b>EX / CROSS :</b></p>	<p><b>Packaging Unit:</b> 1</p> <p><b>Model:</b> G125-16/14,0 G135-16/11,9 G155-16/11,9 G155-16/14,0 G155-9/15,9 G180-16/11,9 G180-16/14,0 G200-16/11,9 GO210-8/11,8</p>
<p><b>T39691</b></p> 	<p><b>Description:</b> OIL TUBE</p> <p><b>OEM No :</b> 976 269 0034</p> <p><b>EX / CROSS :</b> 960 269 0434</p>	<p><b>Packaging Unit:</b> 1</p> <p><b>Model:</b> G100-12 G131-9 G140-8 G141-9 G181-9 G210-16/14,2-0,83 G211-12 Klauen G211-16/17,03-1,0 G221-9/10,19-1,00 G230-12 Klauen G230-16/14,2-0,83 G231-16/17,03-1,0 G240-16/11,72-0,69 G241-16 Klauen G260-16/9,75-0,57 G280-16 Klauen G281-12 Klauen G330-12/11,64-0,78 GO170-6/8,2-1,0 GO190-6/8,2-1,0 GO210-6/6,53-0,80 GO230-6/6,5-0,8 GO240-8/6,57-0,63 GO250-8/6,57-0,63</p>
<p><b>T57208</b></p> 	<p><b>Description:</b> ORING (100X3)</p> <p><b>OEM No :</b> 028 997 2348</p> <p><b>EX / CROSS :</b> 004 997 2248</p>	<p><b>Packaging Unit:</b> 10</p> <p><b>Model:</b> G100-12 G131-9 G140-8 G181-9 G211-12 Klauen G211-16/17,03-1,0 G221-9/10,19-1,00 G230-12 Klauen G230-16/14,2-0,83 G231-16/17,03-1,0 G240-16/11,72-0,69 G260-16/9,75-0,57 G281-12 Klauen G330-12/11,64-0,78 GO190-6/8,2-1,0 GO210-6/6,53-0,80 GO230-6/6,5-0,8</p>
<p><b>T50112</b></p> 	<p><b>Description:</b> ORING (112X2,5)</p> <p><b>OEM No :</b> 029 997 5748</p> <p><b>EX / CROSS :</b></p>	<p><b>Packaging Unit:</b> 1</p> <p><b>Model:</b> G125-16/14,0 G131-9 G135-16/11,9 G141-9 G155-16/11,9 G155-16/14,0 G155-9/15,9 G180-16/11,9 G180-16/14,0 G181-9 G200-16/11,9 G210-16/14,2-0,83 G211-16/17,03-1,0 G221-9/10,19-1,00 G230-16/14,2-0,83 G231-16/17,03-1,0 G240-16/11,72-0,69 G241-16 Klauen G260-16/9,75-0,57 G280-16 Klauen GO210-8/11,8</p>



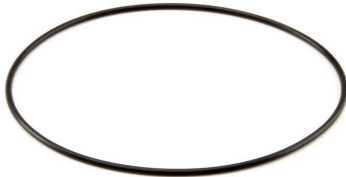



<p><b>T57261</b></p> 	<p><b>Description:</b> ORING (12X4,5)</p> <p><b>OEM No :</b> 015 997 2748</p> <p><b>EX / CROSS :</b></p>	<p><b>Packaging Unit:</b> 20</p>	<p><b>Model:</b> G281-12 Klauen G330-12/11,64-0,78</p>
<p><b>T57257</b></p> 	<p><b>Description:</b> ORING (13,3X2,4)</p> <p><b>OEM No :</b> 013 997 0148</p> <p><b>EX / CROSS :</b></p>	<p><b>Packaging Unit:</b> 1</p>	<p><b>Model:</b> G100-12 G131-9 G155-16/11,9 G155-16/14,0 G180-16/11,9 G180-16/14,0 G181-9 G211-12 Klauen G211-16/17,03-1,0 G230-12 Klauen G230-16/14,2-0,83 G231-16/17,03-1,0 G241-16 Klauen G260-16/9,75-0,57 G280-16 Klauen G281-12 Klauen GO170-6/8,2-1,0 GO190-6/8,2-1,0</p>
<p><b>T49901</b></p> 	<p><b>Description:</b> ORING (149,5X3)</p> <p><b>OEM No :</b> 015 997 2848</p> <p><b>EX / CROSS :</b> 020 997 8548</p>	<p><b>Packaging Unit:</b> 1</p>	<p><b>Model:</b> G155-16/11,9 G155-16/14,0 G180-16/11,9 G180-16/14,0 G181-9 G200-16/11,9 G210-16/14,2-0,83 G211-16/17,03-1,0 G221-9/10,19-1,00 G230-16/14,2-0,83 G231-16/17,03-1,0 G240-16/11,72-0,69 G241-16 Klauen G260-16/9,75-0,57 G280-16 Klauen G281-12 Klauen G330-12/11,64-0,78</p>
<p><b>T63561</b></p> 	<p><b>Description:</b> ORING (14X4)</p> <p><b>OEM No :</b> 019 997 8348</p> <p><b>EX / CROSS :</b></p>	<p><b>Packaging Unit:</b> 5</p>	<p><b>Model:</b> G100-12 G140-8 G230-12 Klauen G281-12 Klauen GO240-8/6,57-0,63 GO250-8/6,57-0,63</p>
<p><b>T50089</b></p> 	<p><b>Description:</b> ORING (72,4X5,3)</p> <p><b>OEM No :</b> 014 997 5148</p> <p><b>EX / CROSS :</b> 020 997 8648</p>	<p><b>Packaging Unit:</b> 1</p>	<p><b>Model:</b> G125-16/14,0 G135-16/11,9 G155-16/11,9 G155-16/14,0 G155-9/15,9 G180-16/11,9 G180-16/14,0 G200-16/11,9 G210-16/14,2-0,83 G211-16/17,03-1,0 G221-9/10,19-1,00 G230-16/14,2-0,83 G231-16/17,03-1,0 G240-16/11,72-0,69 G241-16 Klauen G260-16/9,75-0,57 G280-16 Klauen G281-12 Klauen G330-12/11,64-0,78 GO210-8/11,8</p>







<p><b>T49932</b></p> 	<p><b>Description:</b> ORING 138X3</p>	<p><b>Packaging Unit:</b> 10</p>
	<p><b>OEM No :</b> 020 997 7848</p>	<p><b>Model:</b> G100-12 G140-8 G181-9 G200-16/11,9 G210-16/14,2-0,83 G211-12 Klauen G211-16/17,03-1,0 G221-9/10,19-1,00 G230-12 Klauen G230-16/14,2-0,83 G231-16/17,03-1,0 G240-16/11,72-0,69 G241-16 Klauen G260-16/9,75-0,57 G280-16 Klauen G281-12 Klauen G330-12/11,64-0,78 GO170-6/8,2-1,0 GO190-6/8,2-1,0 GO210-6/6,53-0,80 GO230-6/6,5-0,8 GO240-8/6,57-0,63 GO250-8/6,57-0,63 GO4/160-6/8,2</p>
<p><b>T61944</b></p> 	<p><b>Description:</b> ORING 19,2X3</p>	<p><b>Packaging Unit:</b> 10</p>
	<p><b>OEM No :</b> 013 997 0048</p>	<p><b>Model:</b> G100-12 G131-9 G181-9 G211-12 Klauen G211-16/17,03-1,0 G230-16/14,2-0,83 G231-16/17,03-1,0 G241-16 Klauen G260-16/9,75-0,57 G280-16 Klauen G281-12 Klauen GO170-6/8,2-1,0 GO190-6/8,2-1,0</p>
<p><b>T50027</b></p> 	<p><b>Description:</b> ORING 55,6X3</p>	<p><b>Packaging Unit:</b> 5</p>
	<p><b>OEM No :</b> 022 997 4248</p>	<p><b>Model:</b> G100-12 G140-8 G200-16/11,9 G210-16/14,2-0,83 G211-12 Klauen G211-16/17,03-1,0 G230-12 Klauen G230-16/14,2-0,83 G231-16/17,03-1,0 G241-16 Klauen G260-16/9,75-0,57 G280-16 Klauen</p>
<p><b>T55299</b></p> 	<p><b>Description:</b> ORING 5X3</p>	<p><b>Packaging Unit:</b> 10</p>
	<p><b>OEM No :</b> 015 997 4048</p>	<p><b>Model:</b> G100-12 G140-8 G211-12 Klauen G230-12 Klauen G281-12 Klauen G330-12/11,64-0,78 GO170-6/8,2-1,0 GO190-6/8,2-1,0 GO240-8/6,57-0,63 GO250-8/6,57-0,63</p>
<p><b>T50074</b></p> 	<p><b>Description:</b> ORING 89,5X3</p>	<p><b>Packaging Unit:</b> 1</p>
	<p><b>OEM No :</b> 020 997 8948</p>	<p><b>Model:</b> G125-16/14,0 G131-9 G135-16/11,9 G141-9 G155-16/11,9 G155-16/14,0 G155-9/15,9 G180-16/11,9 G180-16/14,0 G200-16/11,9 G210-16/14,2-0,83 G211-12 Klauen G211-16/17,03-1,0 G230-16/14,2-0,83 G241-16 Klauen G280-16 Klauen GO210-8/11,8</p>



<p><b>T39627</b></p> 	<p><b>Description:</b> PIN</p> <p><b>OEM No :</b> 945 268 0474</p> <p><b>EX / CROSS :</b> 387 268 2374</p>	<p><b>Packaging Unit:</b> 1</p> <p><b>Model:</b> MPS KIT</p>
<p><b>T61994</b></p> 	<p><b>Description:</b> PIN</p> <p><b>OEM No :</b> 960 265 0774</p> <p><b>EX / CROSS :</b> 960 265 0574 945 265 2974 945 265 2774 945 265 1974</p>	<p><b>Packaging Unit:</b> 1</p> <p><b>Model:</b> G100-12 G141-9 G155-16/11,9 G155-16/14,0 G180-16/11,9 G180-16/14,0 G211-12 Klauen G211-16/17,03-1,0 G221-9/10,19-1,00 G230-12 Klauen G231-16/17,03-1,0 G240-16/11,72-0,69 G260-16/9,75-0,57 G281-12 Klauen G330-12/11,64-0,78 GO170-6/8,2-1,0 GO190-6/8,2-1,0 GO210-6/6,53-0,80 GO240-8/6,57-0,63</p>
<p><b>T75814</b></p> 	<p><b>Description:</b> PIN (Ø 16)</p> <p><b>OEM No :</b> 327 991 0060</p> <p><b>EX / CROSS :</b></p>	<p><b>Packaging Unit:</b> 1</p> <p><b>Model:</b> HL 5/1 Z-10 HL 5/2 DZ-10 BRAZIL HL 5/2 Z(S)-10 BRAZIL HL 5/2 Z-10 HL 5/2 ZL-10 HL 5/2 ZS-10 HL 5/60 DZ-10</p>
<p><b>T41444</b></p> 	<p><b>Description:</b> PIN W/BALL</p> <p><b>OEM No :</b> 970 260 2054</p> <p><b>EX / CROSS :</b></p>	<p><b>Packaging Unit:</b> 1</p> <p><b>Model:</b></p>
<p><b>T49331</b></p> 	<p><b>Description:</b> PIN W/BALL</p> <p><b>OEM No :</b> 970 260 1554</p> <p><b>EX / CROSS :</b> 970 260 0754</p>	<p><b>Packaging Unit:</b> 1</p> <p><b>Model:</b> G56-6 G60-6/9,20-1,00 G85-6/6,70-0,83 GO110-6/6,1-0,747</p>



<p><b>T50029</b></p> 	<p><b>Description:</b> PISTON</p> <p><b>OEM No :</b> 945 267 0218</p> <p><b>EX / CROSS :</b> 387 267 0918 387 267 0618</p>	<p><b>Packaging Unit:</b> 1</p> <p><b>Model:</b> G100-12 G125-16/14,0 G135-16/11,9 G140-8 G155-16/11,9 G155-16/14,0 G180-16/11,9 G180-16/14,0 G200-16/11,9 G210-16/14,2-0,83 G211-12 Klauen G211-16/17,03-1,0 G230-12 Klauen G230-16/14,2-0,83 G231-16/17,03-1,0 G240-16/11,72-0,69 G241-16 Klauen G260-16/9,75-0,57 G280-16 Klauen G281-12 Klauen G330-12/11,64-0,78 GV4/110-6/9,0 GV4/65-6/9,0 GV4/95-6/9,0</p>
<p><b>T57269</b></p> 	<p><b>Description:</b> PISTON</p> <p><b>OEM No :</b> 930 267 0618</p> <p><b>EX / CROSS :</b> 960 267 0118</p>	<p><b>Packaging Unit:</b> 1</p> <p><b>Model:</b> G211-12 Klauen G230-12 Klauen G230-16/14,2-0,83 G240-16/11,72-0,69 G241-16 Klauen G280-16 Klauen G281-12 Klauen</p>
<p><b>T15166</b></p> 	<p><b>Description:</b> PIVOT</p> <p><b>OEM No :</b> 389 262 0407</p> <p><b>EX / CROSS :</b></p>	<p><b>Packaging Unit:</b> 5</p> <p><b>Model:</b> G155-16/11,9 G155-16/14,0 G155-9/15,9 G180-16/11,9 G180-16/14,0 G200-16/11,9 G210-16/14,2-0,83 G211-16/17,03-1,0 G221-9/10,19-1,00 G230-16/14,2-0,83 G231-16/17,03-1,0 G240-16/11,72-0,69 G241-16 Klauen G260-16/9,75-0,57 G280-16 Klauen G281-12 Klauen G330-12/11,64-0,78 GO210-8/11,8</p>
<p><b>T08962</b></p> 	<p><b>Description:</b> PIVOT</p> <p><b>OEM No :</b> (346 350 0654/S)</p> <p><b>EX / CROSS :</b></p>	<p><b>Packaging Unit:</b> 5</p> <p><b>Model:</b></p>
<p><b>T16901</b></p> 	<p><b>Description:</b> PIVOT</p> <p><b>OEM No :</b> (389 260 0397/SHAFT)</p> <p><b>EX / CROSS :</b></p>	<p><b>Packaging Unit:</b> 1</p> <p><b>Model:</b> G125-16/14,0 G135-16/11,9</p>



<p><b>T08030</b></p> 	<p><b>Description:</b> PIVOT</p> <p><b>Packaging Unit:</b> 1</p> <p><b>OEM No :</b> 354 353 0174</p> <p><b>Model:</b> HL 5/1 Z-10 HL 5/2 DZ-10 BRAZIL HL 5/2 Z(S)-10 BRAZIL HL 5/2 Z-10 HL 5/2 ZL-10 HL 5/2 ZS-10 HL 5/60 DZ-10 HO 5/4 Z-10 HO 5/8 DZ-10</p> <p><b>EX / CROSS :</b> 354 353 0074</p>
<p><b>T15280</b></p> 	<p><b>Description:</b> PIVOT</p> <p><b>Packaging Unit:</b> 1</p> <p><b>OEM No :</b> (440 260 0097/SHAFT)</p> <p><b>Model:</b></p> <p><b>EX / CROSS :</b></p>
<p><b>T15770</b></p> 	<p><b>Description:</b> PIVOT</p> <p><b>Packaging Unit:</b> 1</p> <p><b>OEM No :</b> (355 350 0354/S)</p> <p><b>Model:</b></p> <p><b>EX / CROSS :</b></p>
<p><b>T19658</b></p> 	<p><b>Description:</b> PIVOT</p> <p><b>Packaging Unit:</b> 1</p> <p><b>OEM No :</b> TAS51379</p> <p><b>Model:</b></p> <p><b>EX / CROSS :</b> (652 350 0054/S) (355 350 0454/S)</p>
<p><b>T94209</b></p> 	<p><b>Description:</b> PIVOT</p> <p><b>Packaging Unit:</b> 1</p> <p><b>OEM No :</b> 655 254 0206/PIVOT</p> <p><b>Model:</b></p> <p><b>EX / CROSS :</b></p>



<p><b>T17385</b></p> 	<p><b>Description:</b> PIVOT REVERSE</p> <p><b>OEM No :</b> 976 263 0030</p> <p><b>EX / CROSS :</b> 945 263 0030</p>	<p><b>Packaging Unit:</b> 1</p> <p><b>Model:</b> G100-12 G131-9 G140-8 G141-9 G155-16/11,9 G155-16/14,0 G180-16/11,9 G180-16/14,0 G181-9 G200-16/11,9 G210-16/14,2-0,83 G211-12 Klauen G211-16/17,03-1,0 G221-9/10,19-1,00 G230-12 Klauen G230-16/14,2-0,83 G231-16/17,03-1,0 G240-16/11,72-0,69 G241-16 Klauen G260-16/9,75-0,57 G280-16 Klauen G281-12 Klauen G330-12/11,64-0,78</p>
<p><b>T53254</b></p> 	<p><b>Description:</b> PLANETARY CARRIER EMPTY</p> <p><b>OEM No :</b> 947 260 6361</p> <p><b>EX / CROSS :</b></p>	<p><b>Packaging Unit:</b> 1</p> <p><b>Model:</b> G211-12 Klauen G230-12 Klauen</p>
<p><b>T15515</b></p> 	<p><b>Description:</b> PLANETARY CARRIER EMPTY</p> <p><b>OEM No :</b> 385 260 3061</p> <p><b>EX / CROSS :</b> 385 260 1761 385 260 0861</p>	<p><b>Packaging Unit:</b> 1</p> <p><b>Model:</b> G3/65-8/9,29 G3/65-9/13,36 G3/90-8/9,29</p>
<p><b>T12339</b></p> 	<p><b>Description:</b> PLANETARY CARRIER EMPTY</p> <p><b>OEM No :</b> 389 260 8961</p> <p><b>EX / CROSS :</b></p>	<p><b>Packaging Unit:</b> 1</p> <p><b>Model:</b> G155-16/11,9 G155-16/14,0 G155-9/15,9 G180-16/11,9 G180-16/14,0 G200-16/11,9 GO210-8/11,8</p>
<p><b>T17261</b></p> 	<p><b>Description:</b> PLANETARY CARRIER EMPTY</p> <p><b>OEM No :</b> 389 260 0661</p> <p><b>EX / CROSS :</b></p>	<p><b>Packaging Unit:</b> 1</p> <p><b>Model:</b> G155-16/11,9 G155-16/14,0 G155-9/15,9 G180-16/11,9 G180-16/14,0 GO210-8/11,8</p>

**T19491**

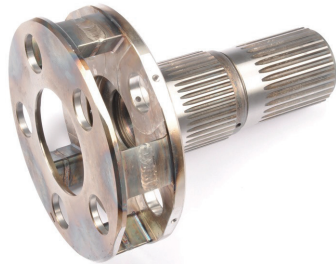

**Description:**

PLANETARY CARRIER EMPTY

**Packaging Unit:** 1

**OEM No :**

946 260 3661

**Model:**

G210-16/14,2-0,83  
G211-16/17,03-1,0  
G230-16/14,2-0,83  
G231-16/17,03-1,0  
G240-16/11,72-0,69  
G241-16 Klauen  
G260-16/9,75-0,57  
G280-16 Klauen  
G281-12 Klauen  
G330-12/11,64-0,78

**EX / CROSS :**

946 260 3561

945 260 4561

945 260 4461

**T63435**



**Description:**

PLANETARY CARRIER EMPTY

**Packaging Unit:** 1

**OEM No :**

947 260 1961

**Model:**

G131-9  
G141-9

**EX / CROSS :**

947 260 4561

947 260 9361

**T38798**



**Description:**

PLANETARY CARRIER EMPTY (30-44T.)

**Packaging Unit:** 1

**OEM No :**

946 260 4161

**Model:**

G181-9  
G221-9/10,19-1,00

**EX / CROSS :**

946 260 4061

**T39048**



**Description:**

PLANETARY CARRIER HUB (85T.)

**Packaging Unit:** 1

**OEM No :**

930 262 0125

**Model:**

**EX / CROSS :**

389 262 1425

**T21059**



**Description:**

PLANETARY CARRIER W/GEARS (28T.)

**Packaging Unit:** 1

**OEM No :**

945 260 4661

**Model:**

G210-16/14,2-0,83  
G211-16/17,03-1,0  
G230-16/14,2-0,83  
G231-16/17,03-1,0  
G240-16/11,72-0,69  
G241-16 Klauen  
G260-16/9,75-0,57  
G280-16 Klauen  
G281-12 Klauen  
G330-12/11,64-0,78

**EX / CROSS :**

945 260 3761

945 260 0261



T70124

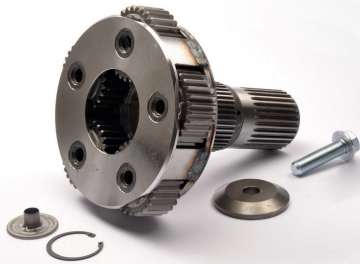

**Description:**

PLANETARY CARRIER W/GEARS (28T.) FOR G221

**Packaging Unit:** 1

**OEM No :**

TAS70124

**Model:**

G221-9/10,19-1,00

**EX / CROSS :**

T41496

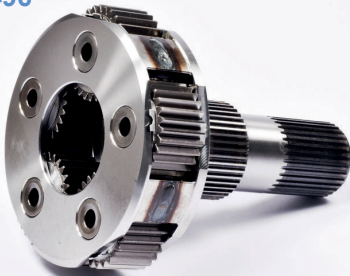

**Description:**

PLANETARY CARRIER W/GEARS (T.)

**Packaging Unit:** 1

**OEM No :**

TAS41496

**Model:**

**EX / CROSS :**

T53265



**Description:**

PLANETARY GEAR

**Packaging Unit:** 1

**OEM No :**

TAS53265

**Model:**

**EX / CROSS :**

T56971



**Description:**

PLANETARY GEAR

**Packaging Unit:** 1

**OEM No :**

TAS56971

**Model:**

**EX / CROSS :**

T15279



**Description:**

PLANETARY GEAR (23T.)

**Packaging Unit:** 1

**OEM No :**

(440 260 0097/G)

**Model:**

**EX / CROSS :**



<p><b>T16902</b></p> 	<p><b>Description:</b> PLANETARY GEAR (26T.)</p> <p><b>OEM No :</b> 389 262 0606</p> <p><b>EX / CROSS :</b></p> <p><b>Model:</b> G125-16/14,0 G135-16/11,9</p>	<p><b>Packaging Unit:</b> 1</p>
<p><b>T15156</b></p> 	<p><b>Description:</b> PLANETARY GEAR (26T.)</p> <p><b>OEM No :</b> (389 260 0497/G)</p> <p><b>EX / CROSS :</b></p> <p><b>Model:</b></p>	<p><b>Packaging Unit:</b> 1</p>
<p><b>T15165</b></p> 	<p><b>Description:</b> PLANETARY GEAR (28T.)</p> <p><b>OEM No :</b> 945 262 0006</p> <p><b>EX / CROSS :</b></p> <p><b>Model:</b> G210-16/14,2-0,83 G211-16/17,03-1,0 G230-16/14,2-0,83 G231-16/17,03-1,0 G240-16/11,72-0,69 G241-16 Klauen G260-16/9,75-0,57 G280-16 Klauen G281-12 Klauen G330-12/11,64-0,78</p>	<p><b>Packaging Unit:</b> 1</p>
<p><b>T69373</b></p> 	<p><b>Description:</b> PLANETARY GEAR (28T.)</p> <p><b>OEM No :</b> 945 262 0206</p> <p><b>EX / CROSS :</b></p> <p><b>Model:</b> G221-9/10,19-1,00</p>	<p><b>Packaging Unit:</b> 1</p>
<p><b>T15278</b></p> 	<p><b>Description:</b> PLANETARY GEAR KIT (5 PCS) (23T.)</p> <p><b>OEM No :</b> 440 260 0097</p> <p><b>EX / CROSS :</b> 385 262 0407</p> <p><b>Model:</b> G3/65-8/9,29 G3/65-9/13,36 G3/90-8/9,29 UG3/40-8/13,01 UNIMOG UG3/65-8/13,01 UNIMOG</p>	<p><b>Packaging Unit:</b> 1</p>





T65571



**Description:**  
PLANETARY PINION CARRIER ASSEMBLY

**Packaging Unit:** 1

**OEM No :**  
TAS65571

**Model:**  
G131-9

**EX / CROSS :**

T08832



**Description:**  
PLANETARY REDUCTION GEAR (24T.)

**Packaging Unit:** 1

**OEM No :**  
(000 260 1197/G)

**Model:**

**EX / CROSS :**

T08826



**Description:**  
PLANETARY REDUCTION GEAR (24T.)

**Packaging Unit:** 1

**OEM No :**  
(000 260 0397/G)

**Model:**

**EX / CROSS :**

T16711



**Description:**  
PLANETARY REDUCTION GEAR (26T.)

**Packaging Unit:** 1

**OEM No :**  
(000 260 1497/G)

**Model:**

**EX / CROSS :**

T41498

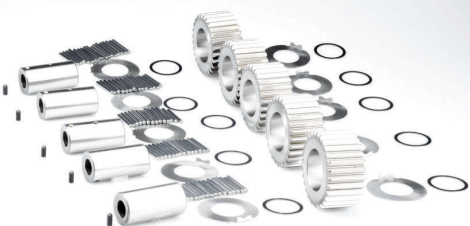

**Description:**  
PLANETARY REPAIR KIT

**Packaging Unit:** 1

**OEM No :**  
947 260 0397

**Model:**  
G211-12 Klauen  
G230-12 Klauen

**EX / CROSS :**

**T53264**



**Description:**  
PLANETARY REPAIR KIT

**Packaging Unit:** 1

**OEM No :**  
947 260 0297

**Model:**  
G211-12 Klauen  
G230-12 Klauen

**EX / CROSS :**  
947 260 0197

**T56957**



**Description:**  
PLANETARY REPAIR KIT

**Packaging Unit:** 1

**OEM No :**  
947 260 0097

**Model:**  
G131-9  
G141-9

**EX / CROSS :**

**T16900**



**Description:**  
PLANETARY REPAIR KIT (26T.)

**Packaging Unit:** 1

**OEM No :**  
389 260 0397

**Model:**  
G125-16/14,0  
G135-16/11,9

**EX / CROSS :**

**T12300**



**Description:**  
PLANETARY REPAIR KIT (26T.)

**Packaging Unit:** 1

**OEM No :**  
389 260 0297

**Model:**  
G155-16/11,9  
G155-16/14,0  
G155-9/15,9  
G180-16/11,9  
G180-16/14,0  
GO210-8/11,8

**EX / CROSS :**

**T93813**



**Description:**  
PLANETARY REPAIR KIT (26T.)

**Packaging Unit:** 1

**OEM No :**  
945 260 0197

**Model:**  
G221-9/10,19-1,00

**EX / CROSS :**



**T15155**



**Description:**

PLANETARY REPAIR KIT (26T.)

**Packaging Unit: 1**

**OEM No :**

389 260 0497

**Model:**

G155-16/11,9  
G155-16/14,0  
G155-9/15,9  
G180-16/11,9  
G180-16/14,0  
G200-16/11,9  
GO210-8/11,8

**EX / CROSS :**

**T15164**



**Description:**

PLANETARY REPAIR KIT (28T.)

**Packaging Unit: 1**

**OEM No :**

946 260 0097

**Model:**

**EX / CROSS :**

655 260 0197

945 260 0097

**T08822**



**Description:**

PLATE

**Packaging Unit: 1**

**OEM No :**

000 077 0425

**Model:**

**EX / CROSS :**

000 077 0325

**T49313**



**Description:**

PLUG (M24X1,5)

**Packaging Unit: 1**

**OEM No :**

210 997 0132

**Model:**

AL 7/1 D-7  
AL 7/5 D-7  
AL 7/8 D-8  
G240-16/11,72-0,69  
G330-12/11,64-0,78  
G56-6  
G60-6/9,20-1,00  
G70-6  
G71-6  
G85-6/6,70-0,83  
G90-6  
GO110-6/6,1-0,747  
HD 7/014 DG-16  
HD 7/014 DGS-16  
HD 7/014 DGS-16 TURKEY  
HD 7/016 DG-13  
HD 7/016 DSG-13  
HD 7/09 DG-10  
HD 7/11 DG-9  
HD 7/19 DG-13  
HD 7/19 DG-13 TURKEY  
HD 7/19 DGS-13  
HD 7/19 DGS-13 TURKEY  
HD 7/19 DSG-13

**EX / CROSS :**

115 997 0032

**T49309**



**Description:**

PLUG (M24X1,5)

**Packaging Unit: 1**

**OEM No :**

210 997 0032

**Model:**

G100-12  
G125-16/14,0  
G135-16/11,9  
G141-9  
G155-16/11,9  
G155-16/14,0  
G155-9/15,9  
G180-16/11,9  
G180-16/14,0  
G181-9  
G200-16/11,9  
G210-16/14,2-0,83  
G211-12 Klauen  
G221-9/10,19-1,00  
G230-16/14,2-0,83  
G231-16/17,03-1,0  
G240-16/11,72-0,69  
G241-16 Klauen  
G260-16/9,75-0,57  
G280-16 Klauen  
G330-12/11,64-0,78  
G56-6  
G60-6/9,20-1,00  
G70-6

**EX / CROSS :**

124 997 0132



<p><b>T45168</b></p> 	<p><b>Description:</b> PRESSURE PLUNGER</p> <p><b>OEM No :</b> 970 262 0274</p> <p><b>EX / CROSS :</b></p>	<p><b>Packaging Unit:</b> 3</p> <p><b>Model:</b> G56-6 G60-8/9,20-1,00 G70-6 G71-6 G85-8/6,70-0,83 G90-6 G0110-6/6,1-0,747 UG100-8/9,57-0,7 GPA UNIMOG</p>
<p><b>T08177</b></p> 	<p><b>Description:</b> PRESSURE PLUNGER</p> <p><b>OEM No :</b> 321 262 0774</p> <p><b>EX / CROSS :</b></p>	<p><b>Packaging Unit:</b> 3</p> <p><b>Model:</b> G3/36-5/8,98 G3/40-5/7,5 G3/40-5/7,5 Indonesian G3/60-5/6,1 Brazil G3/70-4/4,24</p>
<p><b>T08176</b></p> 	<p><b>Description:</b> PRESSURE PLUNGER</p> <p><b>OEM No :</b> 321 262 0674</p> <p><b>EX / CROSS :</b></p>	<p><b>Packaging Unit:</b> 3</p> <p><b>Model:</b> G3/36-5/8,98 G3/40-5/7,5 G3/40-5/7,5 Indonesian G3/60-5/6,1 Brazil</p>
<p><b>T55853</b></p> 	<p><b>Description:</b> PRESSURE PLUNGER</p> <p><b>OEM No :</b> 385 262 0674</p> <p><b>EX / CROSS :</b></p>	<p><b>Packaging Unit:</b> 1</p> <p><b>Model:</b> G3/65-8/9,29 G3/65-9/13,36 G3/90-8/9,29 UG100-8/9,57-0,7 GPA UNIMOG UG3/40-8/13,01 UNIMOG UG3/65-8/13,01 UNIMOG</p>
<p><b>T16991</b></p> 	<p><b>Description:</b> PROPELLER SHAFT FLANGE (22 SPLINES)</p> <p><b>OEM No :</b> 395 410 0030</p> <p><b>EX / CROSS :</b> 389 411 0146</p>	<p><b>Packaging Unit:</b> 1</p> <p><b>Model:</b></p>





T64055



**Description:**

PROPELLER SHAFT SUPPORT W/BEARING

**Packaging Unit:** 1

**OEM No :**

655 410 0022

**Model:**

**EX / CROSS :**

620 410 0010

395 410 0622

395 410 0022

T64059



**Description:**

PROPELLER SHAFT SUPPORT W/BEARING

**Packaging Unit:** 1

**OEM No :**

654 410 0222

**Model:**

**EX / CROSS :**

654 410 0022

620 410 0022

389 410 0222

389 410 0122

T64065



**Description:**

PROPELLER SHAFT SUPPORT W/BEARING

**Packaging Unit:** 1

**OEM No :**

656 411 0012

**Model:**

**EX / CROSS :**

T16993



**Description:**

PROPELLER SHAFT YOKE 180MM 10 HOLES 16MM

**Packaging Unit:** 1

**OEM No :**

395 411 0811

**Model:**

**EX / CROSS :**

395 411 0211

363 411 0111

T84758



**Description:**

PULSE BEARING

**Packaging Unit:** 1

**OEM No :**

002 980 9502

**Model:**

G211-12 Klauen

G230-12 Klauen

**EX / CROSS :**

<p><b>T20414</b></p> 	<p><b>Description:</b> PULSE DISK</p> <p><b>OEM No :</b> 945 262 0528</p> <p><b>EX / CROSS :</b> 389 260 0150</p>	<p><b>Packaging Unit:</b> 1</p> <p><b>Model:</b> G125-16/14,0 G135-16/11,9 G155-16/11,9 G155-16/14,0 G155-9/15,9 G180-16/11,9 G180-16/14,0 G200-16/11,9 G210-16/14,2-0,83 G211-16/17,03-1,0 G230-16/14,2-0,83 G231-16/17,03-1,0 G241-16 Klauen G260-16/9,75-0,57 G280-16 Klauen GO210-8/11,8</p>
<p><b>T57629</b></p> 	<p><b>Description:</b> REAR AXLE SHAFT</p> <p><b>OEM No :</b> 696 357 0101</p> <p><b>EX / CROSS :</b></p>	<p><b>Packaging Unit:</b> 1</p> <p><b>Model:</b> HL 7/015 DL-13</p>
<p><b>T64873</b></p> 	<p><b>Description:</b> REPAIR KIT</p> <p><b>OEM No :</b> 000 350 0413</p> <p><b>EX / CROSS :</b> 000 586 1235</p>	<p><b>Packaging Unit:</b> 1</p> <p><b>Model:</b></p>
<p><b>T51368</b></p> 	<p><b>Description:</b> REPAIR KIT</p> <p><b>OEM No :</b> 000 350 4403</p> <p><b>EX / CROSS :</b></p>	<p><b>Packaging Unit:</b> 1</p> <p><b>Model:</b> HD 7/055 DCGS-13 HD 7/056 DGS-13 HD 7/056 DGS-16</p>
<p><b>T65159</b></p> 	<p><b>Description:</b> REPAIR KIT 9 PLUNGERS &amp; 9 SPRINGS</p> <p><b>OEM No :</b> TAS65159</p> <p><b>EX / CROSS :</b></p>	<p><b>Packaging Unit:</b> 1</p> <p><b>Model:</b> G60-6/9,20-1,00 G85-6/6,70-0,83</p>



T82728



**Description:**  
REPAIR KIT FOR G155/180/200

**Packaging Unit:** 1

**OEM No :**  
TAS82728

**Model:**  
G155-16/11,9  
G180-16/11,9  
G200-16/11,9

**EX / CROSS :**

T65121



**Description:**  
REPAIR KIT FOR INTERM. AXLE

**Packaging Unit:** 1

**OEM No :**  
653 353 9750

**Model:**

**EX / CROSS :**

T94241



**Description:**  
REPAIR KIT MEMBRANE FOR VOITH RETARDER VR115 HV FOR ACTROS

**Packaging Unit:** 1

**OEM No :**  
000 430 3568

**Model:**

**EX / CROSS :**

T79635



**Description:**  
REPAIR KIT SHIFT CONTROL

**Packaging Unit:** 1

**OEM No :**  
945 268 0746/KIT

**Model:**

**EX / CROSS :**

T49298



**Description:**  
RETAINER RING (T.2,39)

**Packaging Unit:** 4

**OEM No :**  
970 994 1141

**Model:**  
G56-6  
G70-6  
G71-6  
G85-6/6,70-0,83  
G90-6  
GO110-6/6,1-0,747

**EX / CROSS :**

**T50093**



**Description:**

RETARDER GEAR (59-56-43T.)

**Packaging Unit:** 1

**OEM No :**

945 264 0420

**Model:**

G240-16/11,72-0,69  
G260-16/9,75-0,57

**EX / CROSS :**

945 264 0220

**T39051**

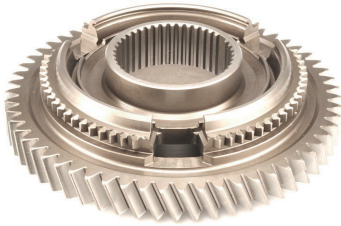

**Description:**

RETARDER GEAR (59-56-43T.)

**Packaging Unit:** 1

**OEM No :**

930 264 0420

**Model:**

G240-16/11,72-0,69  
G241-16 Klauen  
G260-16/9,75-0,57  
G280-16 Klauen  
G281-12 Klauen  
G330-12/11,64-0,78

**EX / CROSS :**

**T50094**



**Description:**

RETARDER GEAR (59-56-43T.)

**Packaging Unit:** 1

**OEM No :**

945 264 0620

**Model:**

G240-16/11,72-0,69  
G260-16/9,75-0,57

**EX / CROSS :**

**T53252**



**Description:**

RETARDER GEAR (59T.)

**Packaging Unit:** 1

**OEM No :**

947 264 0420

**Model:**

G211-12 Klauen  
G230-12 Klauen

**EX / CROSS :**

**T50092**



**Description:**

RETARDER GEAR (63-56-43T.)

**Packaging Unit:** 1

**OEM No :**

945 264 0520

**Model:**

G210-16/14,2-0,83  
G211-16/17,03-1,0  
G221-9/10,19-1,00  
G230-16/14,2-0,83  
G231-16/17,03-1,0  
G240-16/11,72-0,69  
G241-16 Klauen  
G260-16/9,75-0,57  
G280-16 Klauen

**EX / CROSS :**



**T20664**



**Description:**

RETARDER GEAR (63-56-43T.)

**Packaging Unit:** 1

**OEM No :**

389 264 0730

**Model:**

G210-16/14,2-0,83  
G211-16/17,03-1,0  
G221-9/10,19-1,00  
G230-16/14,2-0,83  
G231-16/17,03-1,0  
G240-16/11,72-0,69  
G241-16 Klauen  
G260-16/9,75-0,57  
G280-16 Klauen

**EX / CROSS :**

945 264 0130

**T45151**

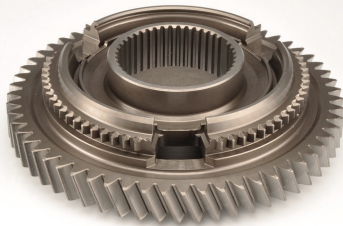

**Description:**

RETARDER GEAR (63T.)

**Packaging Unit:** 1

**OEM No :**

389 264 0830

**Model:**

**EX / CROSS :**

**T38830**



**Description:**

RETARDER GEAR (64-56-43T.)

**Packaging Unit:** 1

**OEM No :**

930 264 0320

**Model:**

G181-9  
G210-16/14,2-0,83  
G211-16/17,03-1,0  
G221-9/10,19-1,00  
G230-16/14,2-0,83  
G231-16/17,03-1,0  
G241-16 Klauen  
G280-16 Klauen  
G281-12 Klauen  
G330-12/11,64-0,78

**EX / CROSS :**

**T67445**



**Description:**

REVERSE GEAR

**Packaging Unit:** 1

**OEM No :**

947 262 1933

**Model:**

G211-12 Klauen  
G230-12 Klauen

**EX / CROSS :**

947 262 1433

947 262 1533

947 262 1633

947 262 2533

**T67447**



**Description:**

REVERSE GEAR

**Packaging Unit:** 1

**OEM No :**

947 263 1231

**Model:**

G230-12 Klauen





**EX / CROSS :**

947 263 1431

947 263 1131

947 263 1031



<p><b>T20289</b></p> 	<p><b>Description:</b> REVERSE GEAR (18T.)</p> <p><b>OEM No :</b> 389 263 1531</p> <p><b>EX / CROSS :</b></p> <p><b>Model:</b> G155-16/11,9 G155-16/14,0 G180-16/11,9 G180-16/14,0 G200-16/11,9</p>	<p><b>Packaging Unit:</b> 1</p>
<p><b>T67454</b></p> 	<p><b>Description:</b> REVERSE GEAR (18T.)</p> <p><b>OEM No :</b> 947 263 0731</p> <p><b>EX / CROSS :</b></p> <p><b>Model:</b> G131-9 G141-9</p>	<p><b>Packaging Unit:</b> 1</p>
<p><b>T17272</b></p> 	<p><b>Description:</b> REVERSE GEAR (19T.)</p> <p><b>OEM No :</b> 389 263 1631</p> <p><b>EX / CROSS :</b></p> <p><b>Model:</b> G155-9/15,9 GO210-8/11,8</p>	<p><b>Packaging Unit:</b> 1</p>
<p><b>T63244</b></p> 	<p><b>Description:</b> REVERSE GEAR (19T.)</p> <p><b>OEM No :</b> 945 263 0231</p> <p><b>EX / CROSS :</b> 945 263 0431 945 263 0331</p> <p><b>Model:</b> G181-9 G221-9/10,19-1,00</p>	<p><b>Packaging Unit:</b> 1</p>
<p><b>T08603</b></p> 	<p><b>Description:</b> REVERSE GEAR (20T.)</p> <p><b>OEM No :</b> 383 263 0031</p> <p><b>EX / CROSS :</b></p> <p><b>Model:</b> G3/50-5/8,5 G3/50-5/8,5 Brazil G3/60-5/5,4 G3/60-5/6,1 G3/60-5/7,5 G3/60-5/7,5 Brazil G3/61-5/6,1 G3/61-5/6,1 Brazil GO3/60-5/5,4 GO3/60-5/5,4 Turkey GO3/80-4/4,43</p>	<p><b>Packaging Unit:</b> 1</p>

<p><b>T01153</b></p> 	<p><b>Description:</b> REVERSE GEAR (20T.)</p> <p><b>OEM No :</b> 322 260 0825</p> <p><b>EX / CROSS :</b> 322 260 0725 322 260 0325</p>	<p><b>Packaging Unit:</b> 1</p> <p><b>Model:</b> G3/36-5/8,98 G3/40-5/7,5 G3/40-5/7,5 Indonesian</p>
<p><b>T01162</b></p> 	<p><b>Description:</b> REVERSE GEAR (20T.)</p> <p><b>OEM No :</b> 337 260 1625</p> <p><b>EX / CROSS :</b> 337 260 1425 337 260 0525</p>	<p><b>Packaging Unit:</b> 1</p> <p><b>Model:</b> G3/60-5/6,1 Brazil</p>
<p><b>T17379</b></p> 	<p><b>Description:</b> REVERSE GEAR (21T.)</p> <p><b>OEM No :</b> 389 263 1031</p> <p><b>EX / CROSS :</b></p>	<p><b>Packaging Unit:</b> 1</p> <p><b>Model:</b> G210-16/14,2-0,83 G211-16/17,03-1,0 G230-16/14,2-0,83 G231-16/17,03-1,0 G240-16/11,72-0,69 G241-16 Klauen G260-16/9,75-0,57 G280-16 Klauen</p>
<p><b>T61934</b></p> 	<p><b>Description:</b> REVERSE GEAR (21T.)</p> <p><b>OEM No :</b> 389 263 1931</p> <p><b>EX / CROSS :</b></p>	<p><b>Packaging Unit:</b> 1</p> <p><b>Model:</b> GO170-6/8,2-1,0 GO190-6/8,2-1,0 GO210-6/6,53-0,80 GO230-6/6,5-0,8</p>
<p><b>T45613</b></p> 	<p><b>Description:</b> REVERSE GEAR (21T.)</p> <p><b>OEM No :</b> 970 263 0331</p> <p><b>EX / CROSS :</b> 970 263 0231 694 263 0031 694 263 0131 970 263 0031</p>	<p><b>Packaging Unit:</b> 1</p> <p><b>Model:</b> G60-6/9,20-1,00 G85-6/6,70-0,83 GO110-6/6,1-0,747</p>

**T57247**



**Description:**  
REVERSE GEAR (24T.)

**Packaging Unit:** 1

**OEM No :**  
930 263 0031

**Model:**  
G281-12 Klauen  
G330-12/11,64-0,78

**EX / CROSS :**  
948 263 0231

**T08287**



**Description:**  
REVERSE GEAR (26T.)

**Packaging Unit:** 1

**OEM No :**  
314 260 0725

**Model:**  
G2/24-5/6,71  
G2/24-5/7,31

**EX / CROSS :**  
314 260 0425

**T15538**



**Description:**  
REVERSE GEAR (34-37T.)

**Packaging Unit:** 1

**OEM No :**  
389 262 0333

**Model:**  
G155-16/11,9  
G155-16/14,0  
G180-16/11,9  
G180-16/14,0  
G200-16/11,9

**EX / CROSS :**  
389 262 0033

**T18840**



**Description:**  
REVERSE GEAR (34-37T.)

**Packaging Unit:** 1

**OEM No :**  
389 262 1033

**Model:**  
G155-16/11,9  
G155-16/14,0  
G180-16/11,9  
G180-16/14,0  
G200-16/11,9

**EX / CROSS :**

**T69368**



**Description:**  
REVERSE GEAR (36-37T.)

**Packaging Unit:** 1

**OEM No :**  
930 262 0333

**Model:**  
G181-9  
G221-9/10,19-1,00

**EX / CROSS :**





**T19069**



**Description:**  
REVERSE GEAR (36-37T.)

**Packaging Unit:** 1

**OEM No :**  
389 262 1833

**Model:**  
GO210-8/11,8

**EX / CROSS :**

**T08201**



**Description:**  
REVERSE GEAR (36-45T.)

**Packaging Unit:** 1

**OEM No :**  
322 263 0433

**Model:**  
G3/36-5/8,98  
G3/40-5/7,5  
G3/40-5/7,5 Indonesian

**EX / CROSS :**  
322 263 0333

**T08344**



**Description:**  
REVERSE GEAR (36-48T.)

**Packaging Unit:** 1

**OEM No :**  
383 262 0033

**Model:**  
G3/50-5/8,5  
G3/50-5/8,5 Brazil  
G3/60-5/6,1  
G3/60-5/7,5  
G3/60-5/7,5 Brazil  
G3/61-5/6,1  
G3/61-5/6,1 Brazil  
GO3/60-5/5,4  
GO3/60-5/5,4 Turkey

**EX / CROSS :**

**T62434**



**Description:**  
REVERSE GEAR (36T.)

**Packaging Unit:** 1

**OEM No :**  
945 262 3533

**Model:**  
G221-9/10,19-1,00

**EX / CROSS :**  
945 262 4133  
945 262 0633

**T58295**

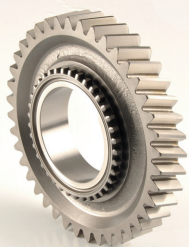

**Description:**  
REVERSE GEAR (40-37T.)

**Packaging Unit:** 1

**OEM No :**  
930 262 0233

**Model:**  
G240-16/11,72-0,69  
G260-16/9,75-0,57

**EX / CROSS :**

<p><b>T17371</b></p> 	<p><b>Description:</b> REVERSE GEAR (40-37T.)</p> <p><b>OEM No :</b> 389 262 1733</p> <p><b>EX / CROSS :</b></p>	<p><b>Packaging Unit:</b> 1</p> <p><b>Model:</b> G210-16/14,2-0,83 G240-16/11,72-0,69</p>
<p><b>T39046</b></p> 	<p><b>Description:</b> REVERSE GEAR (40-37T.)</p> <p><b>OEM No :</b> 945 262 4433</p> <p><b>EX / CROSS :</b></p>	<p><b>Packaging Unit:</b> 1</p> <p><b>Model:</b> G210-16/14,2-0,83 G211-16/17,03-1,0 G230-16/14,2-0,83 G231-16/17,03-1,0 G240-16/11,72-0,69 G241-16 Klauen G260-16/9,75-0,57 G280-16 Klauen</p>
<p><b>T45301</b></p> 	<p><b>Description:</b> REVERSE GEAR (40-37T.)</p> <p><b>OEM No :</b> 945 262 3333</p> <p><b>EX / CROSS :</b> 389 262 2133</p>	<p><b>Packaging Unit:</b> 1</p> <p><b>Model:</b> G210-16/14,2-0,83 G211-16/17,03-1,0 G230-16/14,2-0,83 G231-16/17,03-1,0 G240-16/11,72-0,69 G241-16 Klauen G260-16/9,75-0,57 G280-16 Klauen</p>
<p><b>T15520</b></p> 	<p><b>Description:</b> REVERSE GEAR (40-37T.)</p> <p><b>OEM No :</b> 945 262 3233</p> <p><b>EX / CROSS :</b> 389 262 2033</p>	<p><b>Packaging Unit:</b> 1</p> <p><b>Model:</b></p>
<p><b>T91947</b></p> 	<p><b>Description:</b> REVERSE GEAR (41T.)</p> <p><b>OEM No :</b> 960 262 0433</p> <p><b>EX / CROSS :</b></p>	<p><b>Packaging Unit:</b> 1</p> <p><b>Model:</b> G211-12 Klauen</p>

**T38832**

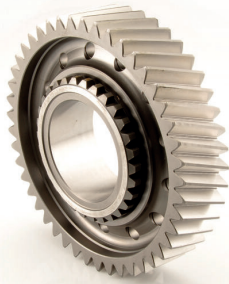

**Description:**  
REVERSE GEAR (45-30T.)

**Packaging Unit:** 1

**OEM No :**  
930 262 0033

**Model:**  
G281-12 Klauen  
G330-12/11,64-0,78

**EX / CROSS :**

**T38833**

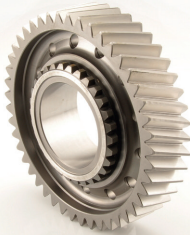

**Description:**  
REVERSE GEAR (45-30T.)

**Packaging Unit:** 1

**OEM No :**  
930 262 0133

**Model:**  
G281-12 Klauen  
G330-12/11,64-0,78

**EX / CROSS :**  
948 262 0233

**T49304**



**Description:**  
REVERSE GEAR (47-27T.)

**Packaging Unit:** 1

**OEM No :**  
970 262 0533

**Model:**  
G60-6/9,20-1,00  
G85-6/6,70-0,83  
GO110-6/6,1-0,747

**EX / CROSS :**  
975 262 0133  
695 262 0133  
970 262 0433  
695 262 0233

**T61918**



**Description:**  
REVERSE GEAR (47-37T.)

**Packaging Unit:** 1

**OEM No :**  
389 262 2233

**Model:**  
GO170-6/8,2-1,0  
GO190-6/8,2-1,0  
GO210-6/6,53-0,80  
GO230-6/6,5-0,8

**EX / CROSS :**  
389 262 2733

**T54591**



**Description:**  
RING

**Packaging Unit:** 1

**OEM No :**  
946 356 0015

**Model:**  
HL 6/1 DC(L,S)-13  
(REINFORCED)  
HL 6/1 DC(LC)-13 (OLD  
VERSION)  
HL 6/1 DC(LC)-13  
(REINFORCED)  
HL 6/3 DC(L,S)-13 (OLD  
VERSION)  
HL 8/1 DCS-13  
HO 6/1 DCL(S)-13  
HO 6/2 DCL(S)-13  
HO 6/4 DCL(S)-13  
HO 6/5 DCL(S)-13

**EX / CROSS :**







<p><b>T19888</b></p> 	<p><b>Description:</b> RING GEAR (76T.)</p> <p><b>OEM No :</b> 385 262 0208</p> <p><b>EX / CROSS :</b> 385 262 0008</p> <p><b>Model:</b> G3/65-8/9,29 G3/65-9/13,36 G3/90-8/9,29</p>	<p><b>Packaging Unit:</b> 1</p>
<p><b>T56959</b></p> 	<p><b>Description:</b> RING GEAR (80T.)</p> <p><b>OEM No :</b> 947 262 1208</p> <p><b>EX / CROSS :</b> 947 262 1108 947 262 1308</p> <p><b>Model:</b> G131-9 G141-9</p>	<p><b>Packaging Unit:</b> 1</p>
<p><b>T12341</b></p> 	<p><b>Description:</b> RING GEAR (80T.)</p> <p><b>OEM No :</b> 389 262 0208</p> <p><b>EX / CROSS :</b></p> <p><b>Model:</b> G155-16/11,9 G155-16/14,0 G155-9/15,9 G180-16/11,9 G180-16/14,0 GO210-8/11,8</p>	<p><b>Packaging Unit:</b> 1</p>
<p><b>T17255</b></p> 	<p><b>Description:</b> RING GEAR (85T.)</p> <p><b>OEM No :</b> 945 262 0108</p> <p><b>EX / CROSS :</b> 389 262 0808</p> <p><b>Model:</b> G210-16/14,2-0,83 G211-16/17,03-1,0 G221-9/10,19-1,00 G230-16/14,2-0,83 G231-16/17,03-1,0 G240-16/11,72-0,69 G260-16/9,75-0,57 G330-12/11,64-0,78</p>	<p><b>Packaging Unit:</b> 1</p>
<p><b>T39047</b></p> 	<p><b>Description:</b> RING GEAR (85T.)</p> <p><b>OEM No :</b> 945 262 0808</p> <p><b>EX / CROSS :</b> 945 262 0208</p> <p><b>Model:</b> G181-9 G210-16/14,2-0,83 G230-16/14,2-0,83 G240-16/11,72-0,69 G241-16 Klauen G260-16/9,75-0,57 G280-16 Klauen G281-12 Klauen G330-12/11,64-0,78</p>	<p><b>Packaging Unit:</b> 1</p>



<p><b>T67592</b></p> 	<p><b>Description:</b> RING GEAR (85T.)</p> <p><b>OEM No :</b> 947 262 2508</p> <p><b>EX / CROSS :</b></p> <p><b>Model:</b> G211-12 Klauen G230-12 Klauen</p>	<p><b>Packaging Unit:</b> 1</p>
<p><b>T73069</b></p> 	<p><b>Description:</b> ROLLER</p> <p><b>OEM No :</b> 000 254 0017</p> <p><b>EX / CROSS :</b></p> <p><b>Model:</b></p>	<p><b>Packaging Unit:</b> 1</p>
<p><b>T67028</b></p> 	<p><b>Description:</b> ROLLER BEARING (52,00X24,00)</p> <p><b>OEM No :</b> 017 981 8305</p> <p><b>EX / CROSS :</b></p> <p><b>Model:</b> G140-8 G211-12 Klauen G230-12 Klauen GO240-8/6,57-0,63 GO250-8/6,57-0,63</p>	<p><b>Packaging Unit:</b> 1</p>
<p><b>T11722</b></p> 	<p><b>Description:</b> SCREW</p> <p><b>OEM No :</b> 914112 012303</p> <p><b>EX / CROSS :</b></p> <p><b>Model:</b> HL 7/1 D-10 HL 7/1 DL-10 HL 7/1 L-10 HL 7/1 S-10 HL 7/1-10 HL 7/18 D-13 HL 7/18 DS-13 HL 7/3 D-10 HL 7/3 DS-10</p>	<p><b>Packaging Unit:</b> 12</p>
<p><b>T19642</b></p> 	<p><b>Description:</b> SCREW</p> <p><b>OEM No :</b> 000933 010145</p> <p><b>EX / CROSS :</b></p> <p><b>Model:</b> GV4/110-6/9,0 GV4/95-6/9,0</p>	<p><b>Packaging Unit:</b> 1</p>



<p><b>T94210</b></p> 	<p><b>Description:</b> SCREW</p> <p><b>OEM No :</b> 910105 012026</p> <p><b>EX / CROSS :</b></p>	<p><b>Packaging Unit:</b> 1</p> <p><b>Model:</b></p>
<p><b>T19023</b></p> 	<p><b>Description:</b> SCREW (M10X110)</p> <p><b>OEM No :</b> 06 02191 0523</p> <p><b>EX / CROSS :</b></p>	<p><b>Packaging Unit:</b> 1</p> <p><b>Model:</b> HP-0728-E HP-0928 HP-1333 HP-1333-E HP-1342-E HP-1352 HP-1652</p>
<p><b>T75812</b></p> 	<p><b>Description:</b> SCREW (M10X20)</p> <p><b>OEM No :</b> 327 990 0012</p> <p><b>EX / CROSS :</b></p>	<p><b>Packaging Unit:</b> 1</p> <p><b>Model:</b> HL 5/1 Z-10 HL 5/2 DZ-10 BRAZIL HL 5/2 Z(S)-10 BRAZIL HL 5/2 Z-10 HL 5/2 ZL-10 HL 5/2 ZS-10 HL 5/60 DZ-10</p>
<p><b>T60941</b></p> 	<p><b>Description:</b> SCREW (M12X1,5X55)</p> <p><b>OEM No :</b> 001 990 0103</p> <p><b>EX / CROSS :</b></p>	<p><b>Packaging Unit:</b> 20</p> <p><b>Model:</b> HD 7/55 DCGS-13 HD 7/56 DGS-13</p>
<p><b>T75828</b></p> 	<p><b>Description:</b> SCREW (M12X1,5X56)</p> <p><b>OEM No :</b> 386 990 0201</p> <p><b>EX / CROSS :</b></p>	<p><b>Packaging Unit:</b> 1</p> <p><b>Model:</b> HL 5/60 DZ-10</p>



T75829



**Description:**  
SCREW (M12X1,5X92)

**Packaging Unit:** 1

**OEM No :**  
386 990 0301

**Model:**

**EX / CROSS :**

T19173



**Description:**  
SCREW (M12X80 W/WASHER)

**Packaging Unit:** 1

**OEM No :**  
942 990 1704

**Model:**

**EX / CROSS :**  
308676 012022  
000960 012147

T19171



**Description:**  
SCREW (M14X1,5X95)

**Packaging Unit:** 12

**OEM No :**  
914112 014312

**Model:**  
HL 7/013 D-16  
HL 7/015 D-13  
HL 7/015 DL-13  
HL 7/07 D-10  
HL 7/07 DL-10

**EX / CROSS :**  
346 990 2501  
000 990 6704

T19207



**Description:**  
SCREW (M14X100)

**Packaging Unit:** 12

**OEM No :**  
914112 014313

**Model:**  
HL 7/015 D-13 TURKEY  
HL 7/024 D-12,3  
HL 7/024 DL-12,3

**EX / CROSS :**  
005 990 5304  
000 990 8904

T45742



**Description:**  
SCREW (M16X1,5X75)

**Packaging Unit:** 16

**OEM No :**  
001 990 5000

**Model:**  
HD 7/055 DCGS-13  
HD 7/056 DGS-13  
HD 7/056 DGS-16

**EX / CROSS :**



**T49325**



**Description:**  
SCREW (M16X60)

**Packaging Unit:** 1

**OEM No :**  
910105 016005

**Model:**  
G56-6  
G60-6/9,20-1,00  
G85-6/6,70-0,83  
GO110-6/6,1-0,747

**EX / CROSS :**  
000000 005536

**T50091**



**Description:**  
SCREW (M20X1,5X80)

**Packaging Unit:** 1

**OEM No :**  
910105 020025

**Model:**  
G221-9/10,19-1,00  
G240-16/11,72-0,69  
G330-12/11,64-0,78

**EX / CROSS :**  
000000 006750  
000000 005728

**T51667**



**Description:**  
SCREW (M20X1,5X95)

**Packaging Unit:** 1

**OEM No :**  
945 990 0600

**Model:**  
G231-16/17,03-1,0  
G240-16/11,72-0,69

**EX / CROSS :**  
945 990 0100

**T39371**



**Description:**  
SCREW (M24X2X85)

**Packaging Unit:** 1

**OEM No :**  
389 990 2019

**Model:**  
G125-16/14,0  
G135-16/11,9  
G155-16/11,9  
G155-16/14,0  
G155-9/15,9  
G180-16/11,9  
G180-16/14,0  
G181-9  
G200-16/11,9  
G210-16/14,2-0,83  
G211-16/17,03-1,0  
G221-9/10,19-1,00  
G230-16/14,2-0,83  
G231-16/17,03-1,0  
G240-16/11,72-0,69  
G241-16 Klauen  
G260-16/9,75-0,57  
G280-16 Klauen  
GO210-8/11,8

**EX / CROSS :**  
945 990 0019  
389 990 0219

**T41468**



**Description:**  
SCREW RIVET





**Packaging Unit:** 5





**OEM No :**  
001 990 2759





**Model:**  
G131-9  
G141-9  
G181-9  
G211-12 Klauen  
G230-12 Klauen  
G230-16/14,2-0,83  
G231-16/17,03-1,0  
G241-16 Klauen  
G260-16/9,75-0,57  
G280-16 Klauen  
G281-12 Klauen





**EX / CROSS :**



<p><b>T61923</b></p> 	<p><b>Description:</b> SEAL RING</p>	<p><b>Packaging Unit:</b> 1</p>
	<p><b>OEM No :</b> 027 997 3048</p>	<p><b>Model:</b> G100-12 G131-9 G140-8 G141-9 G330-12/11,64-0,78 GO170-6/8,2-1,0 GO190-6/8,2-1,0 GO210-6/6,53-0,80 GO230-6/6,5-0,8 GO240-8/6,57-0,63 GO250-8/6,57-0,63</p>
	<p><b>EX / CROSS :</b> 023 997 6048 023 997 5548</p>	
<p><b>T63263</b></p> 	<p><b>Description:</b> SEAL RING</p>	<p><b>Packaging Unit:</b> 1</p>
	<p><b>OEM No :</b> 000 264 1960</p>	<p><b>Model:</b> G211-16/17,03-1,0 G231-16/17,03-1,0 G260-16/9,75-0,57</p>
	<p><b>EX / CROSS :</b></p>	
<p><b>T57280</b></p> 	<p><b>Description:</b> SEAL RING (42X49)</p>	<p><b>Packaging Unit:</b> 10</p>
	<p><b>OEM No :</b> 007603 042101</p>	<p><b>Model:</b> G100-12 G131-9 G141-9 G181-9 G211-12 Klauen G211-16/17,03-1,0 G230-12 Klauen G230-16/14,2-0,83 G231-16/17,03-1,0 G240-16/11,72-0,69 G241-16 Klauen G280-16 Klauen G281-12 Klauen G330-12/11,64-0,78 GO170-6/8,2-1,0 GO190-6/8,2-1,0</p>
	<p><b>EX / CROSS :</b></p>	
<p><b>T66628</b></p> 	<p><b>Description:</b> SEAL RING KIT</p>	<p><b>Packaging Unit:</b> 1</p>
	<p><b>OEM No :</b> 960 260 3318</p>	<p><b>Model:</b> G140-8 G211-12 Klauen G281-12 Klauen G330-12/11,64-0,78</p>
	<p><b>EX / CROSS :</b> 947 260 0718</p>	
<p><b>T57220</b></p> 	<p><b>Description:</b> SEEGER RING (45X1,75)</p>	<p><b>Packaging Unit:</b> 1</p>
	<p><b>OEM No :</b> 000 994 9841</p>	<p><b>Model:</b> G100-12 G131-9 G140-8 G141-9 G181-9 G210-16/14,2-0,83 G211-12 Klauen G211-16/17,03-1,0 G221-9/10,19-1,00 G230-12 Klauen G230-16/14,2-0,83 G231-16/17,03-1,0 G241-16 Klauen G260-16/9,75-0,57 G280-16 Klauen G281-12 Klauen G330-12/11,64-0,78 GO170-6/8,2-1,0 GO190-6/8,2-1,0 GO210-6/6,53-0,80 GO230-6/6,5-0,8 GO240-8/6,57-0,63 GO250-8/6,57-0,63</p>
	<p><b>EX / CROSS :</b></p>	

<p><b>T61930</b></p> 	<p><b>Description:</b> SEEGER RING (56X3)</p> <p><b>OEM No :</b> 900055 060300</p> <p><b>EX / CROSS :</b> 000 264 5351</p>	<p><b>Packaging Unit:</b> 1</p> <p><b>Model:</b> G100-12 G140-8 G211-12 Klauen G230-12 Klauen GO170-6/8,2-1,0 GO190-6/8,2-1,0 GO210-6/6,53-0,80 GO230-6/6,5-0,8 GO240-8/6,57-0,63 GO250-8/6,57-0,63</p>
<p><b>T50075</b></p> 	<p><b>Description:</b> SEEGER RING (T.2,00)</p> <p><b>OEM No :</b> 000472 060000</p> <p><b>EX / CROSS :</b></p>	<p><b>Packaging Unit:</b> 5</p> <p><b>Model:</b> G131-9 G141-9 G181-9 G210-16/14,2-0,83 G211-16/17,03-1,0 G221-9/10,19-1,00 G230-16/14,2-0,83 G231-16/17,03-1,0 G240-16/11,72-0,69 G241-16 Klauen G260-16/9,75-0,57 G280-16 Klauen G281-12 Klauen G330-12/11,64-0,78</p>
<p><b>T67705</b></p> 	<p><b>Description:</b> SEEGER RING (T.2,40)</p> <p><b>OEM No :</b> 387 262 0473</p> <p><b>EX / CROSS :</b></p>	<p><b>Packaging Unit:</b> 1</p> <p><b>Model:</b> G125-16/14,0 G131-9 G135-16/11,9 G140-8 G141-9 G155-16/11,9 G155-16/14,0 G155-9/15,9 G180-16/11,9 G180-16/14,0 G200-16/11,9 G211-12 Klauen G4/65-6/9,0 G4/65-7/11,0 GO210-8/11,8 GO240-8/6,57-0,63 GO250-8/6,57-0,63 GV4/65-6/9,0</p>
<p><b>T50021</b></p> 	<p><b>Description:</b> SEEGER RING (T.2,45)</p> <p><b>OEM No :</b> 007 994 1841</p> <p><b>EX / CROSS :</b> 006 994 9941</p>	<p><b>Packaging Unit:</b> 1</p> <p><b>Model:</b> G155-16/11,9 G155-16/14,0 G155-9/15,9 G180-16/11,9 G180-16/14,0 G181-9 G200-16/11,9 G210-16/14,2-0,83 G211-12 Klauen G221-9/10,19-1,00 G230-16/14,2-0,83 G231-16/17,03-1,0 G240-16/11,72-0,69 G241-16 Klauen G260-16/9,75-0,57 G280-16 Klauen G281-12 Klauen G330-12/11,64-0,78 GO210-8/11,8</p>
<p><b>T50006</b></p> 	<p><b>Description:</b> SEEGER RING (T.2,45)</p> <p><b>OEM No :</b> 387 262 2173</p> <p><b>EX / CROSS :</b></p>	<p><b>Packaging Unit:</b> 1</p> <p><b>Model:</b> G125-16/14,0 G135-16/11,9 G155-16/11,9 G155-16/14,0 G155-9/15,9 G180-16/11,9 G180-16/14,0 G181-9 G200-16/11,9 G210-16/14,2-0,83 G211-16/17,03-1,0 G221-9/10,19-1,00 G230-16/14,2-0,83 G231-16/17,03-1,0 G240-16/11,72-0,69 G241-16 Klauen G260-16/9,75-0,57 G280-16 Klauen G281-12 Klauen G330-12/11,64-0,78 GO210-8/11,8</p>

<p><b>T62060</b></p> 	<p><b>Description:</b> SEEGER RING (T.2,50)</p> <p><b>OEM No :</b> 389 262 3473</p> <p><b>EX / CROSS :</b></p>	<p><b>Packaging Unit:</b> 1</p>	<p><b>Model:</b> G131-9 G141-9 GO170-6/8,2-1,0 GO190-6/8,2-1,0 GO210-6/6,53-0,80 GO230-6/6,5-0,8</p>
<p><b>T50005</b></p> 	<p><b>Description:</b> SEEGER RING (T.2,50)</p> <p><b>OEM No :</b> 007 994 0041</p> <p><b>EX / CROSS :</b> 387 262 2273 387 262 2073</p>	<p><b>Packaging Unit:</b> 1</p>	<p><b>Model:</b> G125-16/14,0 G135-16/11,9 G155-16/11,9 G155-16/14,0 G155-9/15,9 G180-16/11,9 G180-16/14,0 G181-9 G200-16/11,9 G210-16/14,2-0,83 G221-9/10,19-1,00 G230-16/14,2-0,83 G231-16/17,03-1,0 G240-16/11,72-0,69 G241-16 Klauen G260-16/9,75-0,57 G280-16 Klauen G281-12 Klauen G330-12/11,64-0,78 G4/65-7/11,0 GO210-8/11,8</p>
<p><b>T60798</b></p> 	<p><b>Description:</b> SEEGER RING (T.3,00)</p> <p><b>OEM No :</b> 000472 100000</p> <p><b>EX / CROSS :</b> 970 994 3541</p>	<p><b>Packaging Unit:</b> 1</p>	<p><b>Model:</b> G140-8 G211-12 Klauen G281-12 Klauen G3/90-8/9,29 G60-6/9,20-1,00 G85-6/6,70-0,83 GO110-6/6,1-0,747 HL 2/13 D-6,4 HL 2/4 L-6,4 HL 2/4-6,4 UG100-8/9,57-0,7 GPA UNIMOG UG3/40-8/13,01 UNIMOG UG3/65-8/13,01 UNIMOG</p>
<p><b>T49996</b></p> 	<p><b>Description:</b> SEEGER RING (T.3,00)</p> <p><b>OEM No :</b> 389 994 0041</p> <p><b>EX / CROSS :</b></p>	<p><b>Packaging Unit:</b> 5</p>	<p><b>Model:</b> G181-9 G210-16/14,2-0,83 G211-16/17,03-1,0 G221-9/10,19-1,00 G230-16/14,2-0,83 G231-16/17,03-1,0 G240-16/11,72-0,69 G241-16 Klauen G260-16/9,75-0,57 G280-16 Klauen G281-12 Klauen G330-12/11,64-0,78</p>
<p><b>T19629</b></p> 	<p><b>Description:</b> SEEGER RING (T.3,05)</p> <p><b>OEM No :</b> 387 268 0773</p> <p><b>EX / CROSS :</b></p>	<p><b>Packaging Unit:</b> 1</p>	<p><b>Model:</b> G125-16/14,0 G135-16/11,9 G155-16/11,9 G155-16/14,0 G180-16/11,9 G180-16/14,0 G200-16/11,9 G210-16/14,2-0,83</p>

<p><b>T49961</b></p> 	<p><b>Description:</b> SEEGER RING (T.3,15)</p> <p><b>OEM No :</b> 387 262 8673</p> <p><b>EX / CROSS :</b></p>	<p><b>Packaging Unit:</b> 1</p> <p><b>Model:</b> G155-16/11,9 G155-16/14,0 G180-16/11,9 G180-16/14,0 G200-16/11,9 G210-16/14,2-0,83 G211-12 Klauen G211-16/17,03-1,0 G230-12 Klauen G230-16/14,2-0,83 G231-16/17,03-1,0 G240-16/11,72-0,69</p> <p>G241-16 Klauen G260-16/9,75-0,57 G280-16 Klauen G281-12 Klauen G330-12/11,64-0,78 GO240-8/6,57-0,63 GO250-8/6,57-0,63</p>
<p><b>T49960</b></p> 	<p><b>Description:</b> SEEGER RING (T.3,20)</p> <p><b>OEM No :</b> 387 262 8773</p> <p><b>EX / CROSS :</b></p>	<p><b>Packaging Unit:</b> 1</p> <p><b>Model:</b> G155-16/11,9 G155-16/14,0 G180-16/11,9 G180-16/14,0 G200-16/11,9 G210-16/14,2-0,83 G211-12 Klauen G211-16/17,03-1,0 G230-12 Klauen G230-16/14,2-0,83 G231-16/17,03-1,0 G240-16/11,72-0,69</p> <p>G241-16 Klauen G260-16/9,75-0,57 G280-16 Klauen G281-12 Klauen G330-12/11,64-0,78 GO240-8/6,57-0,63 GO250-8/6,57-0,63</p>
<p><b>T50081</b></p> 	<p><b>Description:</b> SEEGER RING (T.3,94)</p> <p><b>OEM No :</b> 000471 120000</p> <p><b>EX / CROSS :</b></p>	<p><b>Packaging Unit:</b> 1</p> <p><b>Model:</b> G125-16/14,0 G131-9 G135-16/11,9 G141-9 G155-16/11,9 G155-16/14,0 G155-9/15,9 G180-16/11,9 G180-16/14,0 G181-9 G200-16/11,9 G210-16/14,2-0,83</p> <p>G211-12 Klauen G221-9/10,19-1,00 G230-12 Klauen G230-16/14,2-0,83 G231-16/17,03-1,0 G240-16/11,72-0,69 G241-16 Klauen G260-16/9,75-0,57 G280-16 Klauen G281-12 Klauen G330-12/11,64-0,78 GO210-8/11,8</p>
<p><b>T50078</b></p> 	<p><b>Description:</b> SEEGER RING (T.3,94)</p> <p><b>OEM No :</b> 000472 130000</p> <p><b>EX / CROSS :</b></p>	<p><b>Packaging Unit:</b> 1</p> <p><b>Model:</b> G125-16/14,0 G135-16/11,9 G155-16/11,9 G155-16/14,0 G155-9/15,9 G180-16/11,9 G180-16/14,0 G181-9 G200-16/11,9 G210-16/14,2-0,83 G211-12 Klauen G221-9/10,19-1,00</p> <p>G230-12 Klauen G230-16/14,2-0,83 G240-16/11,72-0,69 G241-16 Klauen G260-16/9,75-0,57 G280-16 Klauen G281-12 Klauen G330-12/11,64-0,78 GO210-8/11,8</p>
<p><b>T80902</b></p> 	<p><b>Description:</b> SEEGER RING KIT FOR G210-G240</p> <p><b>OEM No :</b> TAS80902</p> <p><b>EX / CROSS :</b></p>	<p><b>Packaging Unit:</b> 1</p> <p><b>Model:</b> G210-16/14,2-0,83 G240-16/11,72-0,69</p>





T40156



**Description:**  
SENSOR

**Packaging Unit:** 1

**OEM No :**  
TAS40156

**Model:**

**EX / CROSS :**

T73946



**Description:**  
SENSOR

**Packaging Unit:** 1

**OEM No :**  
007 542 2418

**Model:**  
G211-12 Klauen

**EX / CROSS :**  
008 542 7118  
006 542 5218

T75152



**Description:**  
SENSOR

**Packaging Unit:** 1

**OEM No :**  
007 542 7418

**Model:**

**EX / CROSS :**

T73648

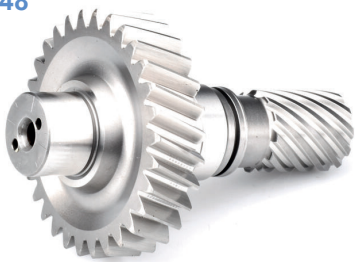

**Description:**  
SHAFT 30 T. VOITH RETARDER VR115HV

**Packaging Unit:** 1

**OEM No :**  
930 438 0510

**Model:**  
VR 115 HV

**EX / CROSS :**

T73650

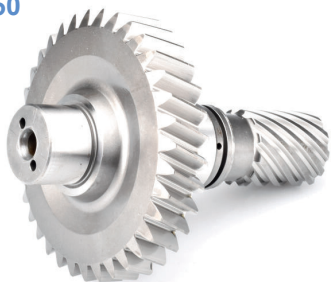

**Description:**  
SHAFT 35 T. VOITH RETARDER VR115HV

**Packaging Unit:** 1

**OEM No :**  
930 438 0610

**Model:**  
VR 115 HV



**EX / CROSS :**  
1530.01834

<p><b>T20290</b></p> 	<p><b>Description:</b> SHAFT P.T.O. (16-30-12T.)</p> <p><b>OEM No :</b> 389 264 0205</p> <p><b>EX / CROSS :</b> 387 264 0105 387 264 0405</p>	<p><b>Packaging Unit:</b> 1</p> <p><b>Model:</b> G211-16/17,03-1,0 G231-16/17,03-1,0 G260-16/9,75-0,57</p>
<p><b>T50100</b></p> 	<p><b>Description:</b> SHAFT P.T.O. (16-30T.)</p> <p><b>OEM No :</b> 947 269 1010</p> <p><b>EX / CROSS :</b> 945 269 1010 945 268 1210</p>	<p><b>Packaging Unit:</b> 1</p> <p><b>Model:</b> G141-9 G181-9 G210-16/14,2-0,83 G211-12 Klauen G211-16/17,03-1,0 G230-12 Klauen G230-16/14,2-0,83 G231-16/17,03-1,0 G240-16/11,72-0,69 G241-16 Klauen G280-16 Klauen G281-12 Klauen G330-12/11,64-0,78</p>
<p><b>T17548</b></p> 	<p><b>Description:</b> SHAFT P.T.O. (16-30T.)</p> <p><b>OEM No :</b> 389 269 1210</p> <p><b>EX / CROSS :</b> 389 269 0210 389 269 0310</p>	<p><b>Packaging Unit:</b> 1</p> <p><b>Model:</b> G221-9/10,19-1,00 G240-16/11,72-0,69</p>
<p><b>T50099</b></p> 	<p><b>Description:</b> SHAFT P.T.O. (16-30T.)</p> <p><b>OEM No :</b> 947 269 1110</p> <p><b>EX / CROSS :</b> 945 269 1110</p>	<p><b>Packaging Unit:</b> 1</p> <p><b>Model:</b> G131-9 G141-9 G181-9 G210-16/14,2-0,83 G211-12 Klauen G211-16/17,03-1,0 G221-9/10,19-1,00 G230-12 Klauen G230-16/14,2-0,83 G231-16/17,03-1,0 G240-16/11,72-0,69 G241-16 Klauen G280-16 Klauen G281-12 Klauen G330-12/11,64-0,78</p>
<p><b>T15511</b></p> 	<p><b>Description:</b> SHAFT TRANSFER CASE (26-26T.)</p> <p><b>OEM No :</b> 343 283 1306</p> <p><b>EX / CROSS :</b> 337 283 5006</p>	<p><b>Packaging Unit:</b> 1</p> <p><b>Model:</b> W600-3W</p>





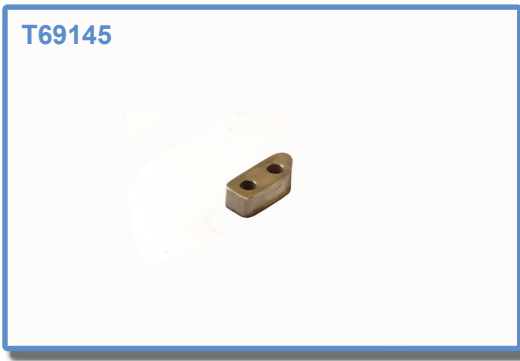

<p><b>T08178</b></p> 	<p><b>Description:</b> SHIFTING PLATE</p> <p><b>OEM No :</b> 321 262 0940</p> <p><b>EX / CROSS :</b></p>	<p><b>Packaging Unit:</b> 3</p> <p><b>Model:</b> G3/36-5/8,98 G3/40-5/7,5 G3/40-5/7,5 Indonesian G3/60-5/6,1 Brazil</p>
<p><b>T19426</b></p> 	<p><b>Description:</b> SHIFTING PLATE</p> <p><b>OEM No :</b> 337 262 0140</p> <p><b>EX / CROSS :</b></p>	<p><b>Packaging Unit:</b> 1</p> <p><b>Model:</b> G3/50-5/8,5 G3/50-5/8,5 Brazil G3/60-5/6,1 G3/60-5/6,1 Brazil G3/60-5/7,5 G3/60-5/7,5 Brazil G3/61-5/6,1 G3/61-5/6,1 Brazil G3/65-8/9,29 G3/65-9/13,36 G3/90-8/9,29 G3/60-5/5,4</p> <p>G03/60-5/5,4 Turkey G03/80-4/4,43 UG3/40-8/13,01 UNIMOG</p>
<p><b>T08179</b></p> 	<p><b>Description:</b> SHIFTING PLATE</p> <p><b>OEM No :</b> 321 262 1040</p> <p><b>EX / CROSS :</b></p>	<p><b>Packaging Unit:</b> 3</p> <p><b>Model:</b> G3/36-5/8,98 G3/40-5/7,5 G3/40-5/7,5 Indonesian G3/60-5/6,1 Brazil G3/70-4/4,24</p>
<p><b>T12326</b></p> 	<p><b>Description:</b> SHIM (T.2,80)</p> <p><b>OEM No :</b> 395 353 0351</p> <p><b>EX / CROSS :</b></p>	<p><b>Packaging Unit:</b> 4</p> <p><b>Model:</b> AL 7/1 D-7 AL 7/1 DS-7 AL 7/5 D-7 HD 7/11 DG-9 HD 7/19 DG-13 HD 7/19 DG-13 TURKEY HD 7/19 DGS-13 HD 7/19 DGS-13 TURKEY HD 7/19 DSG-13 HD 7/2 DG-10 HD 7/2 DLG-10 HD 7/2 DSG-10</p> <p>HD 7/5 DG-10 HL 7/1 D-10 HL 7/1 DL-10 HL 7/1 L-10 HL 7/1 S-10 HL 7/1-10 HL 7/10 D-9 HL 7/18 D-13 HL 7/18 D-13 TURKEY HL 7/18 DS-13 HL 7/18 DS-13 TURKEY HL 7/24 DS-9</p>
<p><b>T08022</b></p> 	<p><b>Description:</b> SHIM (T.3,50)</p> <p><b>OEM No :</b> 327 353 2462</p> <p><b>EX / CROSS :</b></p>	<p><b>Packaging Unit:</b> 1</p> <p><b>Model:</b> HL 5/1 Z-10 HL 5/2 DZ-10 BRAZIL HL 5/2 Z(S)-10 BRAZIL HL 5/2 Z-10 HL 5/2 ZL-10 HL 5/2 ZS-10 HL 5/60 DZ-10 HO 5/4 Z-10 HO 5/8 DZ-10</p>







<p><b>T82165</b></p> 	<p><b>Description:</b> SHIM (T.4,70)</p> <p><b>OEM No :</b> 346 353 2251</p> <p><b>EX / CROSS :</b></p>	<p><b>Packaging Unit:</b> 1</p> <p><b>Model:</b> HL 6/1 DC(L,S)-13 (REINFORCED) HL 6/1 DC(LC)-13 (OLD VERSION) HL 6/1 DC(LC)-13 (REINFORCED) HL 6/3 DC(L,S)-13 (OLD VERSION) HL 7/050 DCS-11,5 HL 7/050 DCS-13 HL 7/052 DS-13 HL 8/1 DCS-13 HO 8/1 DCL(S)-13</p>
<p><b>T82166</b></p> 	<p><b>Description:</b> SHIM (T.4,80)</p> <p><b>OEM No :</b> 346 353 1451</p> <p><b>EX / CROSS :</b></p>	<p><b>Packaging Unit:</b> 1</p> <p><b>Model:</b> HL 6/1 DC(L,S)-13 (REINFORCED) HL 6/1 DC(LC)-13 (OLD VERSION) HL 6/1 DC(LC)-13 (REINFORCED) HL 6/3 DC(L,S)-13 (OLD VERSION) HL 7/050 DCS-11,5 HL 7/050 DCS-13 HL 7/052 DS-13 HL 8/1 DCS-13 HO 8/1 DCL(S)-13</p>
<p><b>T08021</b></p> 	<p><b>Description:</b> SHIM (T.6,00)</p> <p><b>OEM No :</b> 327 353 2162</p> <p><b>EX / CROSS :</b></p>	<p><b>Packaging Unit:</b> 1</p> <p><b>Model:</b> HL 5/1 Z-10 HL 5/2 DZ-10 BRAZIL HL 5/2 Z(S)-10 BRAZIL HL 5/2 Z-10 HL 5/2 ZL-10 HL 5/2 ZS-10 HL 5/60 DZ-10 HO 5/4 Z-10 HO 5/8 DZ-10</p>
<p><b>T69145</b></p> 	<p><b>Description:</b> SLIDING BLOCK</p> <p><b>OEM No :</b> 970 265 0449</p> <p><b>EX / CROSS :</b></p>	<p><b>Packaging Unit:</b> 2</p> <p><b>Model:</b> G60-6/9,20-1,00 G85-6/6,70-0,83</p>
<p><b>T12235</b></p> 	<p><b>Description:</b> SLIDING BLOCK</p> <p><b>OEM No :</b> 389 265 2349</p> <p><b>EX / CROSS :</b></p>	<p><b>Packaging Unit:</b> 2</p> <p><b>Model:</b> G125-16/14,0 G135-16/11,9 G155-16/11,9 G155-16/14,0 G155-9/15,9 G180-16/11,9 G180-16/14,0 G200-16/11,9 G4/110-6/9,0 G4/65-6/9,0 G4/65-7/11,0 G4/95-6/9,0 G4/95-7/11,0 G0210-8/11,8 G04/105-6/7,18 G04/110-5/5,1 G04/120-6/7,18 G04/130-6/7,18 G04/160-6/7,18 G04/95-5/5,1 GV4/110-6/9,0 GV4/65-6/9,0 GV4/95-6/9,0</p>













<p><b>T49332</b></p> 	<p><b>Description:</b> SLIDING BLOCK</p> <p><b>OEM No :</b> 947 265 0849</p> <p><b>EX / CROSS :</b> 976 265 0049 967 265 0149</p>	<p><b>Packaging Unit:</b> 2</p> <p><b>Model:</b> G60-6/9,20-1,00 G70-6 G85-6/6,70-0,83 G90-6 GO110-6/6,1-0,747</p>
<p><b>T67907</b></p> 	<p><b>Description:</b> SLIDING BLOCK</p> <p><b>OEM No :</b> 947 265 0649</p> <p><b>EX / CROSS :</b> 947 265 0149</p>	<p><b>Packaging Unit:</b> 2</p> <p><b>Model:</b> G131-9</p>
<p><b>T14815</b></p> 	<p><b>Description:</b> SLIDING BLOCK</p> <p><b>OEM No :</b> 389 265 2449</p> <p><b>EX / CROSS :</b> 389 265 1249 387 265 0049</p>	<p><b>Packaging Unit:</b> 2</p> <p><b>Model:</b> G125-16/14,0 G135-16/11,9 G155-16/11,9 G155-16/14,0 G155-9/15,9 G180-16/11,9 G180-16/14,0 G200-16/11,9 G210-16/14,2-0,83 G211-16/17,03-1,0 G221-9/10,19-1,00 G231-16/17,03-1,0 G240-16/11,72-0,69 G260-16/9,75-0,57 GO210-8/11,8 GV4/110-6/9,0 GV4/65-6/9,0 GV4/95-6/9,0</p>
<p><b>T18588</b></p> 	<p><b>Description:</b> SLIDING BLOCK</p> <p><b>OEM No :</b> 947 265 0349</p> <p><b>EX / CROSS :</b> 389 265 2749 389 265 1449</p>	<p><b>Packaging Unit:</b> 2</p> <p><b>Model:</b></p>
<p><b>T15527</b></p> 	<p><b>Description:</b> SLIDING BLOCK</p> <p><b>OEM No :</b> 947 265 0249</p> <p><b>EX / CROSS :</b> 945 265 0149 389 265 1349 389 265 1049</p>	<p><b>Packaging Unit:</b> 2</p> <p><b>Model:</b> G100-12 G125-16/14,0 G135-16/11,9 G155-16/11,9 G155-16/14,0 G155-9/15,9 G180-16/11,9 G180-16/14,0 G181-9 G200-16/11,9 G210-16/14,2-0,83 G211-16/17,03-1,0 G230-16/14,2-0,83 G231-16/17,03-1,0 G241-16 Klauen G260-16/9,75-0,57 G280-16 Klauen G4/110-6/9,0 G4/65-6/9,0 G4/65-7/11,0 G4/95-6/9,0 G4/95-7/11,0 GO170-6/8,2-1,0 GO190-6/8,2-1,0</p>

<p><b>T58300</b></p> 	<p><b>Description:</b> SLIDING BLOCK</p> <p><b>OEM No :</b> 947 265 0449</p> <p><b>EX / CROSS :</b></p>	<p><b>Packaging Unit:</b> 2</p> <p><b>Model:</b> G140-8 G230-12 Klauen G241-16 Klauen G280-16 Klauen G281-12 Klauen G330-12/11,64-0,78 G60-6/9,20-1,00 GO240-8/6,57-0,63 GO250-8/6,57-0,63</p>
<p><b>T52102</b></p> 	<p><b>Description:</b> SLIDING BLOCK (SPECIAL EDITION)</p> <p><b>OEM No :</b> 389 265 0049</p> <p><b>EX / CROSS :</b></p>	<p><b>Packaging Unit:</b> 2</p> <p><b>Model:</b></p>
<p><b>T49268</b></p> 	<p><b>Description:</b> SNAP RING</p> <p><b>OEM No :</b> 970 263 0093</p> <p><b>EX / CROSS :</b></p>	<p><b>Packaging Unit:</b> 2</p> <p><b>Model:</b> G60-6/9,20-1,00 G85-6/6,70-0,83 GO110-6/6,1-0,747</p>
<p><b>T94208</b></p> 	<p><b>Description:</b> SNAP RING</p> <p><b>OEM No :</b> 000988 036100</p> <p><b>EX / CROSS :</b></p>	<p><b>Packaging Unit:</b> 1</p> <p><b>Model:</b></p>
<p><b>T49269</b></p> 	<p><b>Description:</b> SNAP RING (T.2,91)</p> <p><b>OEM No :</b> 970 994 1941</p> <p><b>EX / CROSS :</b></p>	<p><b>Packaging Unit:</b> 1</p> <p><b>Model:</b> G60-6/9,20-1,00 G85-6/6,70-0,83 GO110-6/6,1-0,747</p>



<p><b>T68387</b></p> 	<p><b>Description:</b> SOLENOID VALVE</p> <p><b>OEM No :</b> 005 997 6736</p> <p><b>EX / CROSS :</b></p>	<p><b>Packaging Unit:</b> 1</p> <p><b>Model:</b> Brake System</p>
<p><b>T15157</b></p> 	<p><b>Description:</b> SPACER</p> <p><b>OEM No :</b> 389 262 0162</p> <p><b>EX / CROSS :</b> 389 262 6462 389 262 0562</p>	<p><b>Packaging Unit:</b> 10</p> <p><b>Model:</b> G125-16/14,0 G131-9 G135-16/11,9 G141-9 G155-16/11,9 G155-16/14,0 G155-9/15,9 G180-16/11,9 G180-16/14,0 G181-9 G200-16/11,9 G210-16/14,2-0,83</p> <p>G211-12 Klauen G211-16/17,03-1,0 G221-9/10,19-1,00 G230-12 Klauen G230-16/14,2-0,83 G231-16/17,03-1,0 G240-16/11,72-0,69 G241-16 Klauen G260-16/9,75-0,57 G280-16 Klauen G281-12 Klauen G330-12/11,64-0,78</p>
<p><b>T08991</b></p> 	<p><b>Description:</b> SPACER</p> <p><b>OEM No :</b> 346 353 3251</p> <p><b>EX / CROSS :</b> 346 353 2551</p>	<p><b>Packaging Unit:</b> 4</p> <p><b>Model:</b></p>
<p><b>T09028</b></p> 	<p><b>Description:</b> SPACER</p> <p><b>OEM No :</b> 355 354 0162</p> <p><b>EX / CROSS :</b></p>	<p><b>Packaging Unit:</b> 5</p> <p><b>Model:</b> AL 7/1 D-7 AL 7/1 DS-7 AL 7/5 D-7 AL 7/8 D-8 HD 7/014 DG-16 HD 7/014 DGS-16 HD 7/014 DGS-16 TURKEY HD 7/016 DG-13 HD 7/016 DSG-13 HD 7/055 DCGS-13 HD 7/056 DGS-13 HD 7/056 DGS-16</p> <p>HD 7/09 DG-10 HD 7/11 DG-9 HD 7/19 DG-13 HD 7/19 DG-13 TURKEY HD 7/19 DGS-13 HD 7/19 DGS-13 TURKEY HD 7/19 DSG-13 HD 7/2 DG-10 HD 7/2 DLG-10 HD 7/2 DSG-10 HD 7/5 DG-10 HD 7/55 DCGS-13</p>
<p><b>T15271</b></p> 	<p><b>Description:</b> SPACER</p> <p><b>OEM No :</b> 385 262 0152</p> <p><b>EX / CROSS :</b></p>	<p><b>Packaging Unit:</b> 10</p> <p><b>Model:</b> G3/65-8/9,29 G3/65-9/13,36 G3/90-8/9,29 UG100-8/9,57-0,7 GPA UNIMOG UG3/40-8/13,01 UNIMOG UG3/65-8/13,01 UNIMOG</p>





<p><b>T11718</b></p> 	<p><b>Description:</b> SPACER</p> <p><b>OEM No :</b> 615 353 0251</p> <p><b>EX / CROSS :</b></p>	<p><b>Packaging Unit:</b> 4</p> <p><b>Model:</b>            HD 4/02 DG-10            HD 4/02 GD-10            HD 4/03 D-10            HH 4/04 D-12            HH 4/05 D-10 BRAZIL            HH 4/07 DL-10 BRAZIL            HL 4/01 - 10            HL 4/01 D-10            HL 4/01 D-10 BRAZIL            HL 4/01 DL-10            HL 4/01 DL-11,5            HL 4/01 L-10            HL 4/01-10            HL 4/035 D-10,6            HL 4/035 D-9,2            HL 4/038 D-10            HL 4/038 D-12            HL 4/038 D-9,4            HL 4/039 D-10            HL 4/039 D-12            HL 4/039 DL-12            HL 4/05 D-9,2            HL 4/06 D-12            HL 4/06 DL-12</p>
<p><b>T11715</b></p> 	<p><b>Description:</b> SPACER</p> <p><b>OEM No :</b> 615 353 0051</p> <p><b>EX / CROSS :</b> 615 353 0151</p>	<p><b>Packaging Unit:</b> 4</p> <p><b>Model:</b>            HD 4/02 DG-10            HD 4/02 DG-10 BRAZIL            HD 4/02 GD-10            HD 4/03 D-10            HD 4/03 D-10 BRAZIL            HH 4/04 D-12            HH 4/05 D-10 BRAZIL            HH 4/07 DL-10 BRAZIL            HL 4/01 - 10            HL 4/01 D-10            HL 4/01 D-10 BRAZIL            HL 4/01 DL-10            HL 4/01 DL-11,5            HL 4/01 L-10            HL 4/01-10            HL 4/035 D-10,6            HL 4/035 D-9,2            HL 4/038 D-10            HL 4/038 D-12            HL 4/038 D-9,4            HL 4/039 D-10            HL 4/039 D-12            HL 4/039 DL-12            HL 4/05 D-9,2</p>
<p><b>T56713</b></p> 	<p><b>Description:</b> SPACER</p> <p><b>OEM No :</b> 389 262 1862</p> <p><b>EX / CROSS :</b></p>	<p><b>Packaging Unit:</b> 1</p> <p><b>Model:</b>            G131-9            G141-9            GO170-6/8,2-1,0            GO190-6/8,2-1,0            GO210-6/6,53-0,80            GO230-6/6,5-0,8</p>
<p><b>T14942</b></p> 	<p><b>Description:</b> SPACER</p> <p><b>OEM No :</b> 653 353 0051</p> <p><b>EX / CROSS :</b></p>	<p><b>Packaging Unit:</b> 4</p> <p><b>Model:</b>            HD 4/02 DG-10            HD 4/02 GD-10            HD 4/021 GS-10 BRAZIL            HD 4/21 DG-10            HD 4/21 G-10            HD 4/21 G-10 BRAZIL            HD 4/22-10            HD 7/11 DG-9            HD 7/19 DG-13            HD 7/19 DGS-13            HD 7/19 DSG-13            HD 7/2 DG-10            HD 7/2 DLG-10            HD 7/2 DSG-10            HD 7/5 DG-10</p>
<p><b>T39050</b></p> 	<p><b>Description:</b> SPACER</p> <p><b>OEM No :</b> 389 262 0251</p> <p><b>EX / CROSS :</b></p>	<p><b>Packaging Unit:</b> 1</p> <p><b>Model:</b>            G125-16/14,0            G135-16/11,9            G155-16/11,9            G155-16/14,0            G155-9/15,9            G180-16/11,9            G180-16/14,0            G181-9            G200-16/11,9            G210-16/14,2-0,83            G211-16/17,03-1,0            G221-9/10,19-1,00            G230-16/14,2-0,83            G231-16/17,03-1,0            G240-16/11,72-0,69            G241-16 Klauen            G260-16/9,75-0,57            G280-16 Klauen            G281-12 Klauen            G330-12/11,64-0,78            GO210-8/11,8</p>















<p><b>T54592</b></p> 	<p><b>Description:</b> SPACER</p> <p><b>OEM No :</b> 355 356 1215</p> <p><b>EX / CROSS :</b> 355 356 0915</p>	<p><b>Packaging Unit:</b> 1</p> <p><b>Model:</b></p>																								
<p><b>T09027</b></p> 	<p><b>Description:</b> SPACER (31X22,5X1,5)</p> <p><b>OEM No :</b> 355 353 6051</p> <p><b>EX / CROSS :</b></p>	<p><b>Packaging Unit:</b> 4</p> <p><b>Model:</b></p> <table border="0"> <tr> <td>AL 7/1 D-7</td> <td>HL 7/1 L-10</td> </tr> <tr> <td>AL 7/5 D-7</td> <td>HL 7/1 S-10</td> </tr> <tr> <td>HD 7/11 DG-9</td> <td>HL 7/1-10</td> </tr> <tr> <td>HD 7/19 DG-13</td> <td>HL 7/10 D-9</td> </tr> <tr> <td>HD 7/19 DGS-13</td> <td>HL 7/18 D-13</td> </tr> <tr> <td>HD 7/19 DSG-13</td> <td>HL 7/18 DS-13</td> </tr> <tr> <td>HD 7/2 DG-10</td> <td>HL 7/24 DS-9</td> </tr> <tr> <td>HD 7/2 DLG-10</td> <td>HL 7/3 D-10</td> </tr> <tr> <td>HD 7/2 DSG-10</td> <td>HL 7/3 DL-10</td> </tr> <tr> <td>HD 7/5 DG-10</td> <td>HL 7/3 DS-10</td> </tr> <tr> <td>HL 7/1 D-10</td> <td>HL 7/4 D-10</td> </tr> <tr> <td>HL 7/1 DL-10</td> <td>HO 7/8 DL-10</td> </tr> </table>	AL 7/1 D-7	HL 7/1 L-10	AL 7/5 D-7	HL 7/1 S-10	HD 7/11 DG-9	HL 7/1-10	HD 7/19 DG-13	HL 7/10 D-9	HD 7/19 DGS-13	HL 7/18 D-13	HD 7/19 DSG-13	HL 7/18 DS-13	HD 7/2 DG-10	HL 7/24 DS-9	HD 7/2 DLG-10	HL 7/3 D-10	HD 7/2 DSG-10	HL 7/3 DL-10	HD 7/5 DG-10	HL 7/3 DS-10	HL 7/1 D-10	HL 7/4 D-10	HL 7/1 DL-10	HO 7/8 DL-10
AL 7/1 D-7	HL 7/1 L-10																									
AL 7/5 D-7	HL 7/1 S-10																									
HD 7/11 DG-9	HL 7/1-10																									
HD 7/19 DG-13	HL 7/10 D-9																									
HD 7/19 DGS-13	HL 7/18 D-13																									
HD 7/19 DSG-13	HL 7/18 DS-13																									
HD 7/2 DG-10	HL 7/24 DS-9																									
HD 7/2 DLG-10	HL 7/3 D-10																									
HD 7/2 DSG-10	HL 7/3 DL-10																									
HD 7/5 DG-10	HL 7/3 DS-10																									
HL 7/1 D-10	HL 7/4 D-10																									
HL 7/1 DL-10	HO 7/8 DL-10																									
<p><b>T15295</b></p> 	<p><b>Description:</b> SPACER (36,2X25,5X4)</p> <p><b>OEM No :</b> 395 353 0551</p> <p><b>EX / CROSS :</b></p>	<p><b>Packaging Unit:</b> 5</p> <p><b>Model:</b></p> <table border="0"> <tr> <td>AL 7/1 D-7</td> <td>HD 7/5 DG-10</td> </tr> <tr> <td>AL 7/1 DS-7</td> <td>HL 7/1 D-10</td> </tr> <tr> <td>AL 7/5 D-7</td> <td>HL 7/1 DL-10</td> </tr> <tr> <td>HD 7/11 DG-9</td> <td>HL 7/1 L-10</td> </tr> <tr> <td>HD 7/19 DG-13</td> <td>HL 7/1 S-10</td> </tr> <tr> <td>HD 7/19 DG-13 TURKEY</td> <td>HL 7/1-10</td> </tr> <tr> <td>HD 7/19 DGS-13</td> <td>HL 7/10 D-9</td> </tr> <tr> <td>HD 7/19 DGS-13 TURKEY</td> <td>HL 7/18 D-13</td> </tr> <tr> <td>HD 7/19 DSG-13</td> <td>HL 7/18 D-13 TURKEY</td> </tr> <tr> <td>HD 7/2 DG-10</td> <td>HL 7/18 DS-13</td> </tr> <tr> <td>HD 7/2 DLG-10</td> <td>HL 7/18 DS-13 TURKEY</td> </tr> <tr> <td>HD 7/2 DSG-10</td> <td>HL 7/24 DS-9</td> </tr> </table>	AL 7/1 D-7	HD 7/5 DG-10	AL 7/1 DS-7	HL 7/1 D-10	AL 7/5 D-7	HL 7/1 DL-10	HD 7/11 DG-9	HL 7/1 L-10	HD 7/19 DG-13	HL 7/1 S-10	HD 7/19 DG-13 TURKEY	HL 7/1-10	HD 7/19 DGS-13	HL 7/10 D-9	HD 7/19 DGS-13 TURKEY	HL 7/18 D-13	HD 7/19 DSG-13	HL 7/18 D-13 TURKEY	HD 7/2 DG-10	HL 7/18 DS-13	HD 7/2 DLG-10	HL 7/18 DS-13 TURKEY	HD 7/2 DSG-10	HL 7/24 DS-9
AL 7/1 D-7	HD 7/5 DG-10																									
AL 7/1 DS-7	HL 7/1 D-10																									
AL 7/5 D-7	HL 7/1 DL-10																									
HD 7/11 DG-9	HL 7/1 L-10																									
HD 7/19 DG-13	HL 7/1 S-10																									
HD 7/19 DG-13 TURKEY	HL 7/1-10																									
HD 7/19 DGS-13	HL 7/10 D-9																									
HD 7/19 DGS-13 TURKEY	HL 7/18 D-13																									
HD 7/19 DSG-13	HL 7/18 D-13 TURKEY																									
HD 7/2 DG-10	HL 7/18 DS-13																									
HD 7/2 DLG-10	HL 7/18 DS-13 TURKEY																									
HD 7/2 DSG-10	HL 7/24 DS-9																									
<p><b>T19070</b></p> 	<p><b>Description:</b> SPACER (T.0,10)</p> <p><b>OEM No :</b> 389 262 5952</p> <p><b>EX / CROSS :</b> 389 262 5852</p>	<p><b>Packaging Unit:</b> 1</p> <p><b>Model:</b></p> <p>G155-16/11,9 G155-16/14,0 G155-9/15,9 G180-16/11,9 G180-16/14,0 G200-16/11,9 G210-16/14,2-0,83 G240-16/11,72-0,69 GO210-6/6,53-0,80 GO210-8/11,8</p>																								
<p><b>T19635</b></p> 	<p><b>Description:</b> SPACER (T.0,30)</p> <p><b>OEM No :</b> 389 262 7954</p> <p><b>EX / CROSS :</b></p>	<p><b>Packaging Unit:</b> 1</p> <p><b>Model:</b></p> <p>G155-16/11,9 G155-16/14,0 G155-9/15,9 G180-16/11,9 G180-16/14,0 G200-16/11,9 G240-16/11,72-0,69 GO210-8/11,8</p>																								



<p><b>T19633</b></p> 	<p><b>Description:</b> SPACER (T.0,40)</p> <p><b>OEM No :</b> 389 262 4452</p> <p><b>EX / CROSS :</b></p> <p><b>Model:</b> G125-16/14,0 G135-16/11,9 G155-16/11,9 G155-16/14,0 G155-9/15,9 G180-16/11,9 G180-16/14,0 G200-16/11,9 GO210-8/11,8 GO4/160-6/8,2</p>	<p><b>Packaging Unit:</b> 1</p>
<p><b>T19632</b></p> 	<p><b>Description:</b> SPACER (T.0,50)</p> <p><b>OEM No :</b> 389 262 2054</p> <p><b>EX / CROSS :</b> 389 262 1954 389 262 1454</p> <p><b>Model:</b> G125-16/14,0 G135-16/11,9 G155-16/11,9 G155-16/14,0 G155-9/15,9 G180-16/11,9 G180-16/14,0 G200-16/11,9 GO210-8/11,8 GO4/160-6/8,2</p>	<p><b>Packaging Unit:</b> 1</p>
<p><b>T20225</b></p> 	<p><b>Description:</b> SPACER (T.0,50)</p> <p><b>OEM No :</b> 389 262 5752</p> <p><b>EX / CROSS :</b></p> <p><b>Model:</b> G155-16/11,9 G155-16/14,0 G155-9/15,9 G180-16/11,9 G180-16/14,0 G200-16/11,9 G210-16/14,2-0,83 G240-16/11,72-0,69 GO210-8/11,8</p>	<p><b>Packaging Unit:</b> 1</p>
<p><b>T15304</b></p> 	<p><b>Description:</b> SPACER (T.1,00)</p> <p><b>OEM No :</b> 659 353 0051</p> <p><b>EX / CROSS :</b> 659 353 0151</p> <p><b>Model:</b> HD 7/014 DG-16 HD 7/014 DGS-16 HD 7/014 DGS-16 TURKEY HD 7/016 DG-13 HD 7/016 DSG-13 HD 7/09 DG-10</p>	<p><b>Packaging Unit:</b> 4</p>
<p><b>T19634</b></p> 	<p><b>Description:</b> SPACER (T.1,20)</p> <p><b>OEM No :</b> 389 262 5552</p> <p><b>EX / CROSS :</b></p> <p><b>Model:</b> G155-16/11,9 G155-16/14,0 G155-9/15,9 G180-16/11,9 G180-16/14,0 G200-16/11,9 G210-16/14,2-0,83 G240-16/11,72-0,69 GO210-8/11,8</p>	<p><b>Packaging Unit:</b> 1</p>

<p><b>T20224</b></p> 	<p><b>Description:</b> SPACER (T.1,73)</p> <p><b>OEM No :</b> 389 262 2155</p> <p><b>EX / CROSS :</b> 389 262 9655</p>	<p><b>Packaging Unit:</b> 1</p> <p><b>Model:</b> G155-16/11,9 G155-16/14,0 G180-16/11,9 G180-16/14,0 G200-16/11,9 G210-16/14,2-0,83 G211-12 Klauen G211-16/17,03-1,0 G230-12 Klauen G230-16/14,2-0,83 G231-16/17,03-1,0 G240-16/11,72-0,69</p> <p>G241-16 Klauen G260-16/9,75-0,57 G280-16 Klauen G281-12 Klauen G330-12/11,64-0,78 GQ240-8/6,57-0,63 GQ250-8/6,57-0,63</p>
<p><b>T19630</b></p> 	<p><b>Description:</b> SPACER (T.1,80)</p> <p><b>OEM No :</b> 389 262 0851</p> <p><b>EX / CROSS :</b></p>	<p><b>Packaging Unit:</b> 1</p> <p><b>Model:</b> G125-16/14,0 G135-16/11,9 G155-16/11,9 G155-16/14,0 G180-16/11,9 G180-16/14,0 G200-16/11,9 G210-16/14,2-0,83</p>
<p><b>T50020</b></p> 	<p><b>Description:</b> SPACER (T.18,00)</p> <p><b>OEM No :</b> 389 262 3754</p> <p><b>EX / CROSS :</b> 945 262 0152 945 262 0052</p>	<p><b>Packaging Unit:</b> 1</p> <p><b>Model:</b> G155-16/11,9 G155-16/14,0 G155-9/15,9 G180-16/11,9 G180-16/14,0 G200-16/11,9 G210-16/14,2-0,83 G211-16/17,03-1,0 G221-9/10,19-1,00 G231-16/17,03-1,0 G240-16/11,72-0,69 G260-16/9,75-0,57</p> <p>GO210-8/11,8</p>
<p><b>T15519</b></p> 	<p><b>Description:</b> SPACER (T.4,00)</p> <p><b>OEM No :</b> 389 262 1854</p> <p><b>EX / CROSS :</b></p>	<p><b>Packaging Unit:</b> 1</p> <p><b>Model:</b> G125-16/14,0 G135-16/11,9 G155-16/11,9 G155-16/14,0 G180-16/11,9 G180-16/14,0 G200-16/11,9 G210-16/14,2-0,83 G240-16/11,72-0,69</p>
<p><b>T14489</b></p> 	<p><b>Description:</b> SPRING</p> <p><b>OEM No :</b> 387 262 1093</p> <p><b>EX / CROSS :</b> 387 262 0993 387 262 0693</p>	<p><b>Packaging Unit:</b> 10</p> <p><b>Model:</b> G100-12 G125-16/14,0 G131-9 G135-16/11,9 G141-9 G155-16/11,9 G155-16/14,0 G155-9/15,9 G180-16/11,9 G180-16/14,0 G181-9 G200-16/11,9</p> <p>G210-16/14,2-0,83 G211-12 Klauen G211-16/17,03-1,0 G221-9/10,19-1,00 G230-12 Klauen G230-16/14,2-0,83 G231-16/17,03-1,0 G240-16/11,72-0,69 G260-16/9,75-0,57 G4/110-6/9,0 G4/65-6/9,0 G4/65-7/11,0</p>



<p><b>T14493</b></p> 	<p><b>Description:</b> SPRING</p> <p><b>OEM No :</b> 389 262 0293</p> <p><b>EX / CROSS :</b></p>	<p><b>Packaging Unit:</b> 10</p> <p><b>Model:</b> G125-16/14,0 G131-9 G135-16/11,9 G141-9 G155-16/11,9 G155-16/14,0 G155-9/15,9 G180-16/11,9 G180-16/14,0 G181-9 G200-16/11,9 G210-16/14,2-0,83</p> <p>G211-12 Klauen G211-16/17,03-1,0 G221-9/10,19-1,00 G230-12 Klauen G230-16/14,2-0,83 G231-16/17,03-1,0 G240-16/11,72-0,69 G241-16 Klauen G260-16/9,75-0,57 G280-16 Klauen G281-12 Klauen G330-12/11,64-0,78</p>
<p><b>T45210</b></p> 	<p><b>Description:</b> SPRING</p> <p><b>OEM No :</b> 970 993 6401</p> <p><b>EX / CROSS :</b> 970 993 4601 970 993 1801 970 993 3501</p>	<p><b>Packaging Unit:</b> 3</p> <p><b>Model:</b> G56-6 G60-6/9,20-1,00 G70-6 G71-6 G85-6/6,70-0,83 G90-6 GO110-6/6,1-0,747 UG100-8/9,57-0,7 GPA UNIMOG</p>
<p><b>T14487</b></p> 	<p><b>Description:</b> SPRING</p> <p><b>OEM No :</b> 387 262 0893</p> <p><b>EX / CROSS :</b> 387 262 0793 960 262 0793</p>	<p><b>Packaging Unit:</b> 10</p> <p><b>Model:</b> G100-12 G125-16/14,0 G135-16/11,9 G140-8 G155-16/11,9 G155-16/14,0 G155-9/15,9 G180-16/11,9 G180-16/14,0 G181-9 G200-16/11,9 G210-16/14,2-0,83</p> <p>G211-16/17,03-1,0 G221-9/10,19-1,00 G230-16/14,2-0,83 G231-16/17,03-1,0 G240-16/11,72-0,69 G241-16 Klauen G260-16/9,75-0,57 G280-16 Klauen G281-12 Klauen G330-12/11,64-0,78 G4/110-6/9,0 G4/65-6/9,0</p>
<p><b>T68238</b></p> 	<p><b>Description:</b> SPRING</p> <p><b>OEM No :</b> 387 993 2101</p> <p><b>EX / CROSS :</b></p>	<p><b>Packaging Unit:</b> 1</p> <p><b>Model:</b> MPS KIT</p>
<p><b>T68241</b></p> 	<p><b>Description:</b> SPRING</p> <p><b>OEM No :</b> 387 993 2201</p> <p><b>EX / CROSS :</b></p>	<p><b>Packaging Unit:</b> 1</p> <p><b>Model:</b> MPS KIT</p>



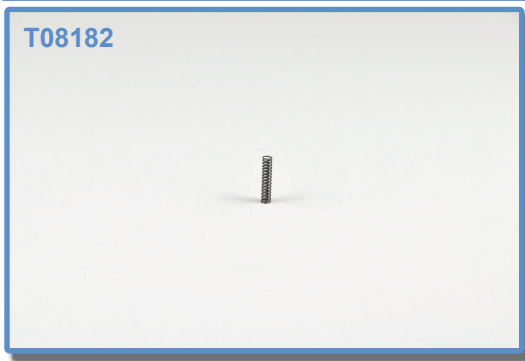

**Description:**  
SPRING

**Packaging Unit:** 3

**OEM No :**  
321 993 0701

**Model:**  
G3/36-5/8,98  
G3/40-5/7,5  
G3/40-5/7,5 Indonesian  
G3/60-5/6,1 Brazil  
G3/70-4/4,24

**EX / CROSS :**



**Description:**  
STEERING KIT FOR DB LS8 ACTROS

**Packaging Unit:** 100

**OEM No :**  
TAS93819

**Model:**

**EX / CROSS :**



**Description:**  
STRG. GEAR SHAFT AND MAIN NUT ASSEMBLY (LESS ROLLER BEARINGS)

**Packaging Unit:** 1

**OEM No :**  
327 460 2308

**Model:**

**EX / CROSS :**



**Description:**  
STRG. GEAR SHAFT AND MAIN NUT ASSEMBLY (LESS ROLLER BEARINGS)

**Packaging Unit:** 1

**OEM No :**  
327 460 2208

**Model:**

**EX / CROSS :**







**Description:**  
SUN GEAR (19T.-34SPL.)

**Packaging Unit:** 1





**OEM No :**  
355 354 0317

**Model:**  
AL 7/1 D-7  
AL 7/1 DS-7  
AL 7/5 D-7  
AL 7/8 D-8  
HD 7/11 DG-9  
HD 7/19 DG-13  
HD 7/19 DG-13 TURKEY  
HD 7/19 DGS-13 TURKEY  
HD 7/19 DSG-13  
HD 7/2 DG-10  
HD 7/2 DLG-10  
HD 7/2 DSG-10  
HD 7/5 DG-10  
HL 7/1 D-10  
HL 7/1 DL-10  
HL 7/1 L-10  
HL 7/1 S-10  
HL 7/1-10  
HL 7/10 D-9  
HL 7/18 D-13  
HL 7/18 D-13 TURKEY  
HL 7/18 DS-13  
HL 7/18 DS-13 TURKEY  
HL 7/24 DS-9

**EX / CROSS :**

<p><b>T09674</b></p> 	<p><b>Description:</b> SUN GEAR (19T.-40SPL.)</p> <p><b>OEM No :</b> 346 354 0517</p> <p><b>EX / CROSS :</b></p>	<p><b>Packaging Unit:</b> 1</p> <p><b>Model:</b> HD 7/014 DG-16 HD 7/014 DGS-16 TURKEY HD 7/016 DG-13 HL 7/013 D-16 HL 7/013 DS-16 TURKEY HL 7/015 D-13 HL 7/021 D-10 HL 7/024 D-12,3 HL 7/024 DL-12,3</p>
<p><b>T18877</b></p> 	<p><b>Description:</b> SUN GEAR (22T.-40SPL.)</p> <p><b>OEM No :</b> 346 354 0917</p> <p><b>EX / CROSS :</b></p>	<p><b>Packaging Unit:</b> 1</p> <p><b>Model:</b> HL 7/015 D-13 HL 7/015 DL-13 HL 7/07 D-10 HL 7/07 DL-10 HL 7/07 DL-11,5</p>
<p><b>T18719</b></p> 	<p><b>Description:</b> SUN GEAR (23T.-34SPL.)</p> <p><b>OEM No :</b> 355 354 0417</p> <p><b>EX / CROSS :</b></p>	<p><b>Packaging Unit:</b> 1</p> <p><b>Model:</b> AL 7/1 D-7 AL 7/5 D-7 HD 7/19 DG-13 HD 7/2 DG-10 HD 7/5 DG-10 HL 7/1 DL-10 HL 7/18 D-13 HL 7/3 D-10</p>
<p><b>T08993</b></p> 	<p><b>Description:</b> SUN GEAR (23T.-40SPL.)</p> <p><b>OEM No :</b> 346 354 0417</p> <p><b>EX / CROSS :</b></p>	<p><b>Packaging Unit:</b> 1</p> <p><b>Model:</b> HD 7/016 DG-13 HD 7/016 DSG-13 HD 7/09 DG-10 HL 7/013 D-16 HL 7/015 D-13 HL 7/015 D-13 TURKEY HL 7/015 DL-13 HL 7/015 DS-13 HL 7/02 DL-10 HL 7/021 D-10 HL 7/021 DL-10 HL 7/024 D-12,3 HL 7/024 DL-12,3 HL 7/07 D-10 HL 7/07 D-11,5 HL 7/07 DL-10 HL 7/07 DL-11,5 HL 7/07 DS-10 HO 7/01 DLS-10 HO 7/02 DLM-10</p>
<p><b>T15411</b></p> 	<p><b>Description:</b> SUN GEAR (25-28T.)</p> <p><b>OEM No :</b> 945 262 0909</p> <p><b>EX / CROSS :</b> 389 262 0909 389 262 0809</p>	<p><b>Packaging Unit:</b> 1</p> <p><b>Model:</b></p>

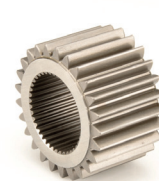

<p><b>T16903</b></p> 	<p><b>Description:</b> SUN GEAR (25T.)</p> <p><b>OEM No :</b> 389 262 0309</p> <p><b>EX / CROSS :</b></p>	<p><b>Packaging Unit:</b> 1</p> <p><b>Model:</b> G125-16/14,0 G135-16/11,9</p>
<p><b>T11790</b></p> 	<p><b>Description:</b> SUN GEAR (25T.)</p> <p><b>OEM No :</b> 389 262 0209</p> <p><b>EX / CROSS :</b></p>	<p><b>Packaging Unit:</b> 1</p> <p><b>Model:</b> G155-16/11,9 G155-16/14,0 G155-9/15,9 G180-16/11,9 G180-16/14,0 G200-16/11,9 GO210-8/11,8</p>
<p><b>T39260</b></p> 	<p><b>Description:</b> SUN GEAR (25T.)</p> <p><b>OEM No :</b> 346 354 2517</p> <p><b>EX / CROSS :</b></p>	<p><b>Packaging Unit:</b> 1</p> <p><b>Model:</b> HD 7/014 DG-16 HD 7/014 DGS-16 TURKEY HD 7/016 DG-13 HD 7/055 DCGS-13 HD 7/056 DGS-13 HD 7/056 DGS-16 HL 7/013 D-16 HL 7/013 DS-16 TURKEY HL 7/015 D-13 HL 7/021 D-10 HL 7/021 DS-10 HL 7/024 D-12,3 HL 7/024 DL-12,3 HL 7/050 DCS-11,5 HL 7/050 DCS-13 HO 7/01 DL-10</p>
<p><b>T15410</b></p> 	<p><b>Description:</b> SUN GEAR (25T.)</p> <p><b>OEM No :</b> 389 262 0409</p> <p><b>EX / CROSS :</b></p>	<p><b>Packaging Unit:</b> 1</p> <p><b>Model:</b> G155-16/11,9 G155-16/14,0 G155-9/15,9 G180-16/11,9 G180-16/14,0 GO210-8/11,8</p>
<p><b>T68270</b></p> 	<p><b>Description:</b> SUN GEAR (25T.)</p> <p><b>OEM No :</b> 947 262 1609</p> <p><b>EX / CROSS :</b> 947 262 1309 947 262 1209 947 262 1109 947 262 1009</p>	<p><b>Packaging Unit:</b> 1</p> <p><b>Model:</b> G211-12 Klauen G230-12 Klauen</p>



T70807



**Description:**  
SUN GEAR (25T.)

**Packaging Unit:** 1

**OEM No :**  
960 262 0009

**Model:**  
G281-12 Klauen  
G330-12/11,64-0,78

**EX / CROSS :**  
948 262 0209

T15270



**Description:**  
SUN GEAR (29T.)

**Packaging Unit:** 1

**OEM No :**  
385 262 0109

**Model:**  
G3/65-8/9,29  
G3/65-9/13,36  
G3/90-8/9,29

**EX / CROSS :**

T60920



**Description:**  
SUN GEAR (29T.)

**Packaging Unit:** 1

**OEM No :**  
346 354 1917

**Model:**  
HD 7/014 DG-16  
HD 7/014 DGS-16 TURKEY  
HD 7/016 DG-13  
HL 7/013 D-16  
HL 7/013 DS-16 TURKEY  
HL 7/015 D-13  
HL 7/021 D-10  
HL 7/024 D-12,3  
HL 7/024 DL-12,3

**EX / CROSS :**

T50151



**Description:**  
SUN GEAR (30T.-40SPL.)

**Packaging Unit:** 1

**OEM No :**  
346 354 3017

**Model:**  
HD 7/055 DCGS-13  
HD 7/056 DGS-13  
HL 7/015 D-13  
HL 7/015 DL-13  
HL 7/024 DL-12,3  
HL 7/07 D-10  
HL 7/07 DL-10  
HL 7/07 DL-11,5  
HO 7/02 DLM-10

**EX / CROSS :**

T50803



**Description:**  
SUN GEAR (30T.)

**Packaging Unit:** 1

**OEM No :**  
945 262 0109

**Model:**  
G221-9/10,19-1,00

**EX / CROSS :**  
945 262 0209



<p><b>T56954</b></p> 	<p><b>Description:</b> SUN GEAR (30T.)</p> <p><b>OEM No :</b> 947 262 0709</p> <p><b>EX / CROSS :</b> 947 262 0809</p>	<p><b>Packaging Unit:</b> 1</p> <p><b>Model:</b> G131-9 G141-9</p>
<p><b>T18740</b></p> 	<p><b>Description:</b> SUN GEAR (35T.-40SPL.)</p> <p><b>OEM No :</b> 346 354 2417</p> <p><b>EX / CROSS :</b></p>	<p><b>Packaging Unit:</b> 1</p> <p><b>Model:</b> HD 7/016 DG-13 HD 7/016 DSG-13 HD 7/055 DCGS-13 HD 7/056 DGS-13 HD 7/056 DGS-16 HD 7/09 DG-10 HL 7/013 D-16 HL 7/015 D-13 HL 7/015 D-13 TURKEY HL 7/015 DL-13 HL 7/015 DS-13 HL 7/02 DL-10 HL 7/021 D-10 HL 7/021 DL-10 HL 7/024 D-12,3 HL 7/024 DL-12,3 HL 7/021 D-10 HL 7/021 DL-10 HL 7/024 D-12,3 HL 7/024 DL-12,3 HL 7/021 D-10 HL 7/07 D-11,5 HL 7/07 DL-10 HL 7/07 DL-11,5 HL 7/07 DS-10</p>
<p><b>T19076</b></p> 	<p><b>Description:</b> SUN GEAR (36T.-40SPL.)</p> <p><b>OEM No :</b> 346 354 1717</p> <p><b>EX / CROSS :</b></p>	<p><b>Packaging Unit:</b> 1</p> <p><b>Model:</b> HD 7/016 DG-13 HD 7/016 DSG-13 HD 7/09 DG-10 HL 7/013 D-16 HL 7/015 D-13 HL 7/015 DL-13 HL 7/015 DS-13 HL 7/02 DL-10 HL 7/021 D-10 HL 7/021 DL-10 HL 7/024 D-12,3 HL 7/024 DL-12,3 HL 7/07 D-10 HL 7/07 D-11,5 HL 7/07 DL-10 HL 7/07 DL-11,5 HL 7/07 DS-10</p>
<p><b>T38645</b></p> 	<p><b>Description:</b> SUN GEAR HYBRID (25T.)</p> <p><b>OEM No :</b> T38645</p> <p><b>EX / CROSS :</b></p>	<p><b>Packaging Unit:</b> 1</p> <p><b>Model:</b></p>
<p><b>T73714</b></p> 	<p><b>Description:</b> SWITCHING DEVICE</p> <p><b>OEM No :</b> 943 260 1509</p> <p><b>EX / CROSS :</b> 943 260 0509</p>	<p><b>Packaging Unit:</b> 1</p> <p><b>Model:</b> G210-16/14,2-0,83 G230-16/14,2-0,83 G240-16/11,72-0,69</p>

**T73704**



**Description:**  
SWITCHING DEVICE

**Packaging Unit:** 1

**OEM No :**  
943 260 1209

**Model:**  
G210-16/14,2-0,83  
G211-12 Klauen  
G211-16/17,03-1,0  
G231-16/17,03-1,0  
G240-16/11,72-0,69  
G241-16 Klauen  
G280-16 Klauen  
G281-12 Klauen  
G330-12/11,64-0,78

**EX / CROSS :**  
943 260 0809  
943 260 0209

**T74722**



**Description:**  
SWITCHING DEVICE

**Packaging Unit:** 1

**OEM No :**  
000 260 3298

**Model:**  
G210-16/14,2-0,83  
G211-12 Klauen  
G211-16/17,03-1,0  
G221-9/10,19-1,00  
G240-16/11,72-0,69  
G281-12 Klauen

**EX / CROSS :**

**T68341**



**Description:**  
SYNCHRO CONE

**Packaging Unit:** 1

**OEM No :**  
945 262 5734

**Model:**  
G131-9  
G141-9

**EX / CROSS :**

**T94331**



**Description:**  
SYNCHRO CONE

**Packaging Unit:** 1

**OEM No :**  
656 262 1334

**Model:**  
GO240-8/6,57-0,63  
GO250-8/6,57-0,63

**EX / CROSS :**  
656 262 0734

**T53256**



**Description:**  
SYNCHRO CONE

**Packaging Unit:** 1

**OEM No :**  
947 262 0634

**Model:**  
G211-12 Klauen  
G230-12 Klauen

**EX / CROSS :**



T44051



**Description:**  
SYNCHRO CONE

**Packaging Unit:** 1

**OEM No :**  
389 262 1134

**Model:**  
G100-12  
GO4/160-6/8,2

**EX / CROSS :**

T56952



**Description:**  
SYNCHRO CONE

**Packaging Unit:** 1

**OEM No :**  
947 262 0334

**Model:**  
G131-9  
G141-9

**EX / CROSS :**

T41469



**Description:**  
SYNCHRO CONE

**Packaging Unit:**

**OEM No :**  
960 262 0934

**Model:**  
G140-8  
GO240-8/6,57-0,63  
GO250-8/6,57-0,63

**EX / CROSS :**

T66797



**Description:**  
SYNCHRO CONE

**Packaging Unit:** 1

**OEM No :**  
976 262 3434

**Model:**  
G71-6  
G90-6  
UG100-8/9,57-0,7 GPA  
UNIMOG

**EX / CROSS :**

T51707







**Description:**  
SYNCHRO CONE (36-51T.)

**Packaging Unit:** 1

**OEM No :**  
945 262 6134

**Model:**  
GO170-6/8,2-1,0  
GO190-6/8,2-1,0  
GO210-6/6,53-0,80  
GO230-6/6,5-0,8

**EX / CROSS :**

<p><b>T38834</b></p> 	<p><b>Description:</b> SYNCHRO CONE (36-58T.)</p> <p><b>OEM No :</b> 930 262 0234</p> <p><b>EX / CROSS :</b> 930 262 0034</p>	<p><b>Packaging Unit:</b> 1</p> <p><b>Model:</b> G241-16 Klauen G280-16 Klauen G281-12 Klauen</p>
<p><b>T12284</b></p> 	<p><b>Description:</b> SYNCHRO CONE (42-44T.)</p> <p><b>OEM No :</b> 945 262 0534</p> <p><b>EX / CROSS :</b> 389 262 5034</p>	<p><b>Packaging Unit:</b> 1</p> <p><b>Model:</b></p>
<p><b>T20990</b></p> 	<p><b>Description:</b> SYNCHRO CONE (42-44T.)</p> <p><b>OEM No :</b> 945 262 8234</p> <p><b>EX / CROSS :</b> 945 262 5434</p>	<p><b>Packaging Unit:</b> 1</p> <p><b>Model:</b></p>
<p><b>T51686</b></p> 	<p><b>Description:</b> SYNCHRO CONE (42-51T.)</p> <p><b>OEM No :</b> 945 262 5034</p> <p><b>EX / CROSS :</b> 389 262 9934 389 262 5734</p>	<p><b>Packaging Unit:</b> 1</p> <p><b>Model:</b> GO170-6/8,2-1,0 GO190-6/8,2-1,0 GO210-6/6,53-0,80 GO230-6/6,5-0,8 GO4/160-6/8,2</p>
<p><b>T08306</b></p> 	<p><b>Description:</b> SYNCHRO CONE (42T.)</p> <p><b>OEM No :</b> 314 262 1434</p> <p><b>EX / CROSS :</b> 314 262 0734</p>	<p><b>Packaging Unit:</b> 1</p> <p><b>Model:</b> G2/24-5/6,71</p>





T08308



**Description:**  
SYNCHRO CONE (42T.)

**Packaging Unit:** 1

**OEM No :**  
314 262 1534

**Model:**  
G2/24-5/7,31

**EX / CROSS :**  
314 262 0834

T08331



**Description:**  
SYNCHRO CONE (45-24T.)

**Packaging Unit:** 1

**OEM No :**  
337 262 1234

**Model:**  
G3/60-5/6,1 Brazil

**EX / CROSS :**  
337 262 1034

T08568



**Description:**  
SYNCHRO CONE (45T.)

**Packaging Unit:** 1

**OEM No :**  
340 262 0134

**Model:**  
G3/40-5/7,5 Indonesian

**EX / CROSS :**  
340 262 0034

T08190



**Description:**  
SYNCHRO CONE (45T.)

**Packaging Unit:** 1

**OEM No :**  
322 262 0434

**Model:**  
G3/36-5/8,98  
G3/40-5/7,5

**EX / CROSS :**  
322 262 0034

T15276



**Description:**  
SYNCHRO CONE (48-28T.)

**Packaging Unit:** 1

**OEM No :**  
385 262 1534

**Model:**  
G3/65-8/9,29  
G3/65-9/13,36  
G3/90-8/9,29

**EX / CROSS :**

<p><b>T15580</b></p> 	<p><b>Description:</b> SYNCHRO CONE (48T.)</p> <p><b>OEM No :</b> 385 262 0434</p> <p><b>EX / CROSS :</b></p>	<p><b>Packaging Unit:</b> 1</p> <p><b>Model:</b> G3/65-8/9,29 G3/65-9/13,36 GO3/60-4/4,43</p>
<p><b>T08345</b></p> 	<p><b>Description:</b> SYNCHRO CONE (48T.)</p> <p><b>OEM No :</b> 383 262 0134</p> <p><b>EX / CROSS :</b></p>	<p><b>Packaging Unit:</b> 1</p> <p><b>Model:</b> G3/50-5/8,5 G3/50-5/8,5 Brazil G3/60-5/6,1 G3/60-5/7,5 G3/60-5/7,5 Brazil G3/61-5/6,1 G3/61-5/6,1 Brazil</p>
<p><b>T15268</b></p> 	<p><b>Description:</b> SYNCHRO CONE (48T.)</p> <p><b>OEM No :</b> 385 260 3245</p> <p><b>EX / CROSS :</b> 385 260 1345</p>	<p><b>Packaging Unit:</b> 1</p> <p><b>Model:</b> G3/65-8/9,29 G3/65-9/13,36 G3/90-8/9,29</p>
<p><b>T15522</b></p> 	<p><b>Description:</b> SYNCHRO CONE (51-48T.)</p> <p><b>OEM No :</b> 945 262 0334</p> <p><b>EX / CROSS :</b> 945 262 0134 389 262 5434</p>	<p><b>Packaging Unit:</b> 1</p> <p><b>Model:</b> G100-12 G131-9 G210-16/14,2-0,83 G211-12 Klauen G211-16/17,03-1,0 G230-12 Klauen G230-16/14,2-0,83 G231-16/17,03-1,0 GO230-6/6,5-0,8 GO4/160-6/8,2</p>
<p><b>T38536</b></p> 	<p><b>Description:</b> SYNCHRO CONE (51-48T.)</p> <p><b>OEM No :</b> 945 262 7734</p> <p><b>EX / CROSS :</b> 945 262 3634 945 262 7834</p>	<p><b>Packaging Unit:</b> 1</p> <p><b>Model:</b> G131-9 G141-9 G181-9 G210-16/14,2-0,83 G211-12 Klauen G211-16/17,03-1,0 G230-12 Klauen G230-16/14,2-0,83 G231-16/17,03-1,0 GO230-6/6,5-0,8</p>

**T15552**



**Description:**  
SYNCHRO CONE (54-44T.)

**Packaging Unit:** 1

**OEM No :**  
945 262 0434

**Model:**

G100-12  
G125-16/14,0  
G135-16/11,9  
G155-16/11,9  
G155-16/14,0  
G155-9/15,9  
G180-16/11,9  
G180-16/14,0  
G200-16/11,9  
G210-16/14,2-0,83  
G211-16/17,03-1,0  
G221-9/10,19-1,00

G230-16/14,2-0,83  
G231-16/17,03-1,0  
G240-16/11,72-0,69  
G260-16/9,75-0,57  
GQ210-8/11,8  
GO4/160-6/8,2

**EX / CROSS :**  
389 262 0034

**T20991**



**Description:**  
SYNCHRO CONE (54-44T.)

**Packaging Unit:** 1

**OEM No :**  
945 262 5534

**Model:**

G181-9  
G210-16/14,2-0,83  
G211-16/17,03-1,0  
G221-9/10,19-1,00  
G230-16/14,2-0,83  
G231-16/17,03-1,0  
G240-16/11,72-0,69  
G260-16/9,75-0,57

**EX / CROSS :**

**T15526**



**Description:**  
SYNCHRO CONE (56-43T.)

**Packaging Unit:** 1

**OEM No :**  
389 262 9234

**Model:**

G181-9  
G210-16/14,2-0,83  
G211-16/17,03-1,0  
G221-9/10,19-1,00  
G230-16/14,2-0,83  
G231-16/17,03-1,0  
G240-16/11,72-0,69  
G241-16 Klauen  
G260-16/9,75-0,57  
G280-16 Klauen

**EX / CROSS :**  
945 262 1234

**T18365**



**Description:**  
SYNCHRO CONE (56-43T.)

**Packaging Unit:** 1

**OEM No :**  
389 262 4434

**Model:**

G210-16/14,2-0,83  
G240-16/11,72-0,69

**EX / CROSS :**

**T18880**



**Description:**  
SYNCHRO CONE (56-43T.)

**Packaging Unit:** 1





**OEM No :**  
945 262 3834

**Model:**

G181-9  
G210-16/14,2-0,83  
G211-16/17,03-1,0  
G221-9/10,19-1,00  
G230-16/14,2-0,83  
G231-16/17,03-1,0  
G240-16/11,72-0,69  
G241-16 Klauen  
G260-16/9,75-0,57  
G280-16 Klauen  
G281-12 Klauen  
G330-12/11,64-0,78

**EX / CROSS :**

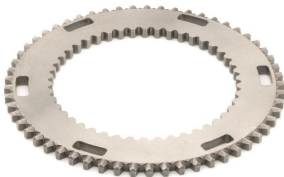

<p><b>T61910</b></p> 	<p><b>Description:</b> SYNCHRO CONE (57-44T.)</p> <p><b>OEM No :</b> 945 262 4934</p> <p><b>EX / CROSS :</b> 389 262 8334</p>	<p><b>Packaging Unit:</b> 1</p> <p><b>Model:</b> GO170-6/8,2-1,0 GO190-6/8,2-1,0 GO210-6/6,53-0,80 GO230-6/6,5-0,8 GO4/160-6/8,2</p>
<p><b>T61913</b></p> 	<p><b>Description:</b> SYNCHRO CONE (57-44T.)</p> <p><b>OEM No :</b> 945 262 4834</p> <p><b>EX / CROSS :</b> 389 262 8234</p>	<p><b>Packaging Unit:</b> 1</p> <p><b>Model:</b> GO170-6/8,2-1,0 GO190-6/8,2-1,0 GO210-6/6,53-0,80 GO230-6/6,5-0,8 GO4/160-6/8,2</p>
<p><b>T51705</b></p> 	<p><b>Description:</b> SYNCHRO CONE (57-44T.)</p> <p><b>OEM No :</b> 945 262 6034</p> <p><b>EX / CROSS :</b></p>	<p><b>Packaging Unit:</b> 1</p> <p><b>Model:</b> GO170-6/8,2-1,0 GO190-6/8,2-1,0 GO210-6/6,53-0,80 GO230-6/6,5-0,8</p>
<p><b>T51703</b></p> 	<p><b>Description:</b> SYNCHRO CONE (57-44T.)</p> <p><b>OEM No :</b> 945 262 5934</p> <p><b>EX / CROSS :</b></p>	<p><b>Packaging Unit:</b> 1</p> <p><b>Model:</b> GO170-6/8,2-1,0 GO190-6/8,2-1,0 GO210-6/6,53-0,80 GO230-6/6,5-0,8</p>
<p><b>T45609</b></p> 	<p><b>Description:</b> SYNCHRO CONE (57-46T.)</p> <p><b>OEM No :</b> 975 262 0334</p> <p><b>EX / CROSS :</b> 970 262 1734 694 262 0234</p>	<p><b>Packaging Unit:</b> 1</p> <p><b>Model:</b> G60-6/9,20-1,00 G71-6 G85-6/6,70-0,83 G90-6</p>





T45611

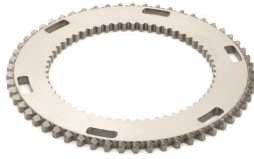

**Description:**  
SYNCHRO CONE (57-58T.)

**Packaging Unit:** 1

**OEM No :**  
975 262 0234

**Model:**  
G60-6/9,20-1,00  
G71-6  
G85-6/6,70-0,83  
G90-6  
GO110-6/6,1-0,747

**EX / CROSS :**  
970 262 2334  
694 262 0334

T45644



**Description:**  
SYNCHRO CONE (60-24T.)

**Packaging Unit:** 1

**OEM No :**  
976 262 1634

**Model:**  
G85-6/6,70-0,83

**EX / CROSS :**  
976 262 1734

T63701



**Description:**  
SYNCHRO CONE (60-32T.)

**Packaging Unit:** 1

**OEM No :**  
656 262 0434

**Model:**  
GO210-6/6,53-0,80

**EX / CROSS :**

T51709



**Description:**  
SYNCHRO CONE (60-35T.)

**Packaging Unit:** 1

**OEM No :**  
945 262 7134

**Model:**  
GO170-6/8,2-1,0  
GO190-6/8,2-1,0  
GO210-6/6,53-0,80  
GO230-6/6,5-0,8

**EX / CROSS :**

T60449



**Description:**  
SYNCHRO CONE (60-35T.)

**Packaging Unit:** 1

**OEM No :**  
389 262 9834

**Model:**  
GO170-6/8,2-1,0  
GO190-6/8,2-1,0  
GO210-6/6,53-0,80  
GO230-6/6,5-0,8

**EX / CROSS :**



T61896



**Description:**  
SYNCHRO CONE (60-38T.)

**Packaging Unit:** 1

**OEM No :**  
389 262 9734

**Model:**  
GO170-6/8,2-1,0  
GO190-6/8,2-1,0

**EX / CROSS :**

T54674

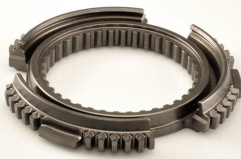

**Description:**  
SYNCHRO CONE (60-38T.)

**Packaging Unit:** 1

**OEM No :**  
945 262 7234

**Model:**  
GO170-6/8,2-1,0  
GO190-6/8,2-1,0

**EX / CROSS :**

T54700



**Description:**  
SYNCHRO CONE (60-42T.)

**Packaging Unit:** 1

**OEM No :**  
694 262 0034

**Model:**  
G60-6/9,20-1,00

**EX / CROSS :**

T19671



**Description:**  
SYNCHRO CONE (60-44T.)

**Packaging Unit:** 1

**OEM No :**  
976 262 2834

**Model:**  
G100-12

**EX / CROSS :**

976 262 0534

T45196



**Description:**  
SYNCHRO CONE (60-46T.)

**Packaging Unit:** 1

**OEM No :**  
970 262 1534



**Model:**  
G60-6/9,20-1,00  
G85-6/6,70-0,83  
GO110-6/6,1-0,747





**EX / CROSS :**

975 262 0134

694 262 0134

693 262 0534

<p><b>T45590</b></p> 	<p><b>Description:</b> SYNCHRO CONE (60-48T.)</p> <p><b>OEM No :</b> 695 262 0034</p> <p><b>EX / CROSS :</b> 975 262 0034</p>	<p><b>Packaging Unit:</b> 1</p> <p><b>Model:</b> G85-6/6,70-0,83 GO110-6/6,1-0,747</p>
<p><b>T15470</b></p> 	<p><b>Description:</b> SYNCHRO CONE (60T.)</p> <p><b>OEM No :</b> 387 262 4834</p> <p><b>EX / CROSS :</b></p>	<p><b>Packaging Unit:</b> 1</p> <p><b>Model:</b> G4/110-6/9,0 G4/65-7/11,0 G4/95-6/9,0 G4/95-7/11,0 GO4/105-6/7,18 GO4/110-5/5,1 GO4/120-6/7,18 GO4/130-6/7,18 GO4/160-6/7,18 GO4/95-5/5,1 GV4/110-6/9,0 GV4/95-6/9,0</p>
<p><b>T12228</b></p> 	<p><b>Description:</b> SYNCHRO CONE (60T.)</p> <p><b>OEM No :</b> 389 262 5634</p> <p><b>EX / CROSS :</b> 389 262 3934 389 262 2434 389 262 1534 389 262 1234</p>	<p><b>Packaging Unit:</b> 1</p> <p><b>Model:</b> G125-16/14,0 G135-16/11,9 G155-16/11,9 G155-16/14,0 G155-9/15,9 G180-16/11,9 G180-16/14,0 G200-16/11,9 G4/110-6/9,0 G4/65-6/9,0 G4/95-6/9,0 GO210-8/11,8 GO4/105-6/7,18 GO4/110-5/5,1 GO4/120-6/7,18 GO4/130-6/7,18 GO4/160-6/7,18 GO4/95-5/5,1 GV4/110-6/9,0 GV4/65-6/9,0 GV4/95-6/9,0</p>
<p><b>T15473</b></p> 	<p><b>Description:</b> SYNCHRO CONE (60T.)</p> <p><b>OEM No :</b> 387 262 5134</p> <p><b>EX / CROSS :</b> 387 262 3134</p>	<p><b>Packaging Unit:</b> 1</p> <p><b>Model:</b> GO4/105-6/7,18 GO4/120-6/7,18 GO4/130-6/7,18 GO4/160-6/7,18</p>
<p><b>T15467</b></p> 	<p><b>Description:</b> SYNCHRO CONE (60T.)</p> <p><b>OEM No :</b> 387 262 4534</p> <p><b>EX / CROSS :</b> 387 262 4134 387 262 4131 387 262 2734</p>	<p><b>Packaging Unit:</b> 1</p> <p><b>Model:</b> G4/110-6/9,0 G4/65-7/11,0 G4/95-6/9,0 G4/95-7/11,0 GO4/105-6/7,18 GO4/110-5/5,1 GO4/120-6/7,18 GO4/130-6/7,18 GO4/160-6/7,18 GO4/95-5/5,1 GV4/110-6/9,0 GV4/95-6/9,0</p>

<p><b>T15471</b></p> 	<p><b>Description:</b> SYNCHRO CONE (60T.)</p> <p><b>OEM No :</b> 387 262 5034</p> <p><b>EX / CROSS :</b> 387 262 0734</p> <p><b>Model:</b> G4/110-6/9,0 G4/65-6/9,0 G4/95-6/9,0 GO4/110-5/5,1 GO4/95-5/5,1 GV4/110-6/9,0 GV4/95-6/9,0</p>	<p><b>Packaging Unit:</b> 1</p>
<p><b>T15546</b></p> 	<p><b>Description:</b> SYNCHRO CONE (60T.)</p> <p><b>OEM No :</b> 945 262 4034</p> <p><b>EX / CROSS :</b></p> <p><b>Model:</b></p>	<p><b>Packaging Unit:</b> 1</p>
<p><b>T16895</b></p> 	<p><b>Description:</b> SYNCHRO CONE (60T.)</p> <p><b>OEM No :</b> 387 262 3234</p> <p><b>EX / CROSS :</b></p> <p><b>Model:</b> GV4/110-6/9,0 GV4/95-6/9,0</p>	<p><b>Packaging Unit:</b> 1</p>
<p><b>T16896</b></p> 	<p><b>Description:</b> SYNCHRO CONE (60T.)</p> <p><b>OEM No :</b> 387 262 3634</p> <p><b>EX / CROSS :</b> 387 262 3534</p> <p><b>Model:</b> GV4/110-6/9,0 GV4/95-6/9,0</p>	<p><b>Packaging Unit:</b> 1</p>
<p><b>T15655</b></p> 	<p><b>Description:</b> SYNCHRO CONE (66-44T.)</p> <p><b>OEM No :</b> 389 262 0534</p> <p><b>EX / CROSS :</b></p> <p><b>Model:</b> G155-9/15,9 GO210-8/11,8</p>	<p><b>Packaging Unit:</b> 1</p>



<p><b>T19035</b></p> 	<p><b>Description:</b> SYNCHRO CONE (66-44T.)</p> <p><b>OEM No :</b> 970 262 2534</p> <p><b>EX / CROSS :</b> 974 262 0034 971 262 1562</p>	<p><b>Packaging Unit:</b> 1</p> <p><b>Model:</b> G56-6 G60-6/9,20-1,00 G85-6/6,70-0,83 GO110-6/6,1-0,747 UG100-8/9,57-0,7 GPA UNIMOG</p>
<p><b>T19033</b></p> 	<p><b>Description:</b> SYNCHRO CONE (66-54T.)</p> <p><b>OEM No :</b> 970 262 2434</p> <p><b>EX / CROSS :</b> 973 262 0134 971 262 0562</p>	<p><b>Packaging Unit:</b> 1</p> <p><b>Model:</b> G60-6/9,20-1,00 G85-6/6,70-0,83 GO110-6/6,1-0,747 UG100-8/9,57-0,7 GPA UNIMOG</p>
<p><b>T17268</b></p> 	<p><b>Description:</b> SYNCHRO CONE (72-44T.)</p> <p><b>OEM No :</b> 389 262 2334</p> <p><b>EX / CROSS :</b> 389 262 0934 389 262 1934</p>	<p><b>Packaging Unit:</b> 1</p> <p><b>Model:</b> G125-16/14,0 G135-16/11,9 G155-16/11,9 G155-16/14,0 G155-9/15,9 G180-16/11,9 G180-16/14,0 GO210-8/11,8</p>
<p><b>T14496</b></p> 	<p><b>Description:</b> SYNCHRO CONE (73-44T.)</p> <p><b>OEM No :</b> 389 262 4034</p> <p><b>EX / CROSS :</b></p>	<p><b>Packaging Unit:</b> 1</p> <p><b>Model:</b> G125-16/14,0 G135-16/11,9 G155-16/11,9 G155-16/14,0 G155-9/15,9 G180-16/11,9 G180-16/14,0 G200-16/11,9 GO210-8/11,8</p>
<p><b>T12232</b></p> 	<p><b>Description:</b> SYNCHRO CONE (73-44T.)</p> <p><b>OEM No :</b> 389 262 9134</p> <p><b>EX / CROSS :</b></p>	<p><b>Packaging Unit:</b> 1</p> <p><b>Model:</b> G125-16/14,0 G135-16/11,9 G155-16/11,9 G155-16/14,0 G155-9/15,9 G180-16/11,9 G180-16/14,0 G200-16/11,9 GO210-8/11,8</p>

**T53250**



**Description:**  
SYNCHRO CONE W/FLANGE

**Packaging Unit:** 1

**OEM No :**  
947 260 0736

**Model:**  
G131-9  
G141-9  
G211-12 Klauen  
G230-12 Klauen

**EX / CROSS :**

**T20995**



**Description:**  
SYNCHRO CONE W/FLANGE (56T.)

**Packaging Unit:** 1

**OEM No :**  
947 260 3036

**Model:**  
G181-9  
G210-16/14,2-0,83  
G211-16/17,03-1,0  
G221-9/10,19-1,00  
G230-16/14,2-0,83  
G231-16/17,03-1,0  
G240-16/11,72-0,69  
G241-16 Klauen  
G260-16/9,75-0,57  
G280-16 Klauen  
G281-12 Klauen  
G330-12/11,64-0,78

**EX / CROSS :**  
947 260 0836

**T14492**



**Description:**  
SYNCHRO CONE W/FLANGE (56T.)

**Packaging Unit:** 1

**OEM No :**  
389 260 2036

**Model:**  
G125-16/14,0  
G135-16/11,9  
G155-16/11,9  
G155-16/14,0  
G155-9/15,9  
G180-16/11,9  
G180-16/14,0  
G200-16/11,9  
G210-16/14,2-0,83  
G211-16/17,03-1,0  
G221-9/10,19-1,00  
G230-16/14,2-0,83  
G231-16/17,03-1,0  
G240-16/11,72-0,69  
G241-16 Klauen  
G260-16/9,75-0,57  
G280-16 Klauen  
GO210-8/11,8

**EX / CROSS :**

**T17262**



**Description:**  
SYNCHRO CONE W/FLANGE (72T.)

**Packaging Unit:** 1

**OEM No :**  
389 260 0936

**Model:**  
G125-16/14,0  
G135-16/11,9  
G155-16/11,9  
G155-16/14,0  
G155-9/15,9  
G180-16/11,9  
G180-16/14,0  
GO210-8/11,8

**EX / CROSS :**

**T68498**



**Description:**  
SYNCHRO HUB

**Packaging Unit:** 1

**OEM No :**  
947 262 0735

**Model:**  
G131-9  
G141-9

**EX / CROSS :**  
947 262 0835



T94350



**Description:**  
SYNCHRO HUB

**Packaging Unit:** 1

**OEM No :**  
656 262 1035

**Model:**  
GO240-8/6,57-0,63

**EX / CROSS :**  
656 262 0735

T94367



**Description:**  
SYNCHRO HUB

**Packaging Unit:** 1

**OEM No :**  
656 262 0235

**Model:**  
G140-8  
GO240-8/6,57-0,63  
GO250-8/6,57-0,63

**EX / CROSS :**

T51970



**Description:**  
SYNCHRO HUB

**Packaging Unit:** 1

**OEM No :**  
694 262 0135

**Model:**  
G60-6/9,20-1,00

**EX / CROSS :**

T68471



**Description:**  
SYNCHRO HUB

**Packaging Unit:** 1

**OEM No :**  
389 262 1135

**Model:**  
G100-12  
GO4/160-6/8,2

**EX / CROSS :**

T68478







**Description:**  
SYNCHRO HUB

**Packaging Unit:** 1

**OEM No :**  
389 262 2735



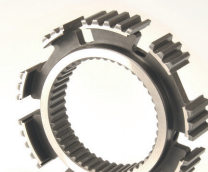

**Model:**  
G100-12  
GO4/160-6/8,2

**EX / CROSS :**

<p><b>T07947</b></p> 	<p><b>Description:</b> SYNCHRO HUB</p> <p><b>OEM No :</b> 322 262 0635</p> <p><b>EX / CROSS :</b> 322 262 0435</p>	<p><b>Packaging Unit:</b> 1</p> <p><b>Model:</b> G3/36-5/8,98 G3/40-5/7,5 G3/40-5/7,5 Indonesian</p>
<p><b>T07949</b></p> 	<p><b>Description:</b> SYNCHRO HUB</p> <p><b>OEM No :</b> 322 262 0735</p> <p><b>EX / CROSS :</b> 322 260 1835 321 262 1835</p>	<p><b>Packaging Unit:</b> 1</p> <p><b>Model:</b> G3/36-5/8,98 G3/40-5/7,5 G3/40-5/7,5 Indonesian</p>
<p><b>T15408</b></p> 	<p><b>Description:</b> SYNCHRO HUB</p> <p><b>OEM No :</b> 385 262 1035</p> <p><b>EX / CROSS :</b></p>	<p><b>Packaging Unit:</b> 1</p> <p><b>Model:</b> G3/65-8/9,29 G3/65-9/13,36 G3/90-8/9,29 UG100-8/9,57-0,7 GPA UNIMO UG3/40-8/13,01 UNIMO UG3/65-8/13,01 UNIMO</p>
<p><b>T75565</b></p> 	<p><b>Description:</b> SYNCHRO HUB</p> <p><b>OEM No :</b> 972 262 0135</p> <p><b>EX / CROSS :</b> 971 262 0635</p>	<p><b>Packaging Unit:</b> 1</p> <p><b>Model:</b> G56-6 G70-6</p>
<p><b>T75582</b></p> 	<p><b>Description:</b> SYNCHRO HUB</p> <p><b>OEM No :</b> 972 262 0735</p> <p><b>EX / CROSS :</b> 973 262 0335</p>	<p><b>Packaging Unit:</b> 1</p> <p><b>Model:</b> G56-6 G70-6</p>





<p><b>T81936</b></p> 	<p><b>Description:</b> SYNCHRO HUB</p> <p><b>OEM No :</b> 947 262 2635</p> <p><b>EX / CROSS :</b> 947 262 1435 947 262 1335</p>	<p><b>Packaging Unit:</b> 1</p> <p><b>Model:</b> G211-12 Klauen G230-12 Klauen</p>
<p><b>T38831</b></p> 	<p><b>Description:</b> SYNCHRO HUB (30-32T.)</p> <p><b>OEM No :</b> 945 262 3635</p> <p><b>EX / CROSS :</b> 930 262 0835 960 262 2235 960 262 3135</p>	<p><b>Packaging Unit:</b> 1</p> <p><b>Model:</b></p>
<p><b>T39044</b></p> 	<p><b>Description:</b> SYNCHRO HUB (37-28T.)</p> <p><b>OEM No :</b> 945 262 3835</p> <p><b>EX / CROSS :</b></p>	<p><b>Packaging Unit:</b> 1</p> <p><b>Model:</b> G210-16/14,2-0,83 G211-16/17,03-1,0 G230-16/14,2-0,83 G231-16/17,03-1,0 G240-16/11,72-0,69 G241-16 Klauen G260-16/9,75-0,57 G280-16 Klauen</p>
<p><b>T12340</b></p> 	<p><b>Description:</b> SYNCHRO HUB (37-28T.)</p> <p><b>OEM No :</b> 389 262 0135</p> <p><b>EX / CROSS :</b></p>	<p><b>Packaging Unit:</b> 1</p> <p><b>Model:</b> G125-16/14,0 G135-16/11,9 G155-16/11,9 G155-16/14,0 G180-16/11,9 G180-16/14,0 G200-16/11,9 G210-16/14,2-0,83 G211-16/17,03-1,0 G230-16/14,2-0,83 G231-16/17,03-1,0 G240-16/11,72-0,69</p> <p>G260-16/9,75-0,57</p>
<p><b>T61921</b></p> 	<p><b>Description:</b> SYNCHRO HUB (37-30T.)</p> <p><b>OEM No :</b> 389 262 4235</p> <p><b>EX / CROSS :</b></p>	<p><b>Packaging Unit:</b> 1</p> <p><b>Model:</b> GO190-6/8,2-1,0 GO210-6/6,53-0,80 GO230-6/6,5-0,8 GO240-8/6,57-0,63 GO4/160-6/8,2</p>



T56715

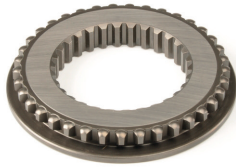

**Description:**  
SYNCHRO HUB (37-30T.)

**Packaging Unit:** 1

**OEM No :**  
389 262 7035

**Model:**  
GO190-6/8,2-1,0  
GO4/160-6/8,2

**EX / CROSS :**  
389 262 4135

T63237



**Description:**  
SYNCHRO HUB (37-32T.)

**Packaging Unit:** 1

**OEM No :**  
945 262 2035

**Model:**  
G181-9  
G221-9/10,19-1,00

**EX / CROSS :**  
945 262 2135

T61825



**Description:**  
SYNCHRO HUB (37T.)

**Packaging Unit:** 1

**OEM No :**  
945 262 3935

**Model:**  
G211-16/17,03-1,0  
G230-16/14,2-0,83  
G241-16 Klauen  
G260-16/9,75-0,57  
G280-16 Klauen

**EX / CROSS :**

T17263



**Description:**  
SYNCHRO HUB (37T.)

**Packaging Unit:** 1

**OEM No :**  
389 262 0040

**Model:**  
G155-9/15,9

**EX / CROSS :**

T17264







**Description:**  
SYNCHRO HUB (37T.)

**Packaging Unit:** 1

**OEM No :**  
389 262 0435

**Model:**  
G155-9/15,9

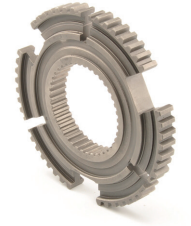
**EX / CROSS :**

<p><b>T08327</b></p> 	<p><b>Description:</b> SYNCHRO HUB (45-8T.)</p> <p><b>OEM No :</b> 337 262 0635</p> <p><b>EX / CROSS :</b> 337 262 0035</p>	<p><b>Packaging Unit:</b> 1</p> <p><b>Model:</b> G3/60-5/6,1 Brazil</p>
<p><b>T08330</b></p> 	<p><b>Description:</b> SYNCHRO HUB (45-8T.)</p> <p><b>OEM No :</b> 337 262 0735</p> <p><b>EX / CROSS :</b> 337 262 0335</p>	<p><b>Packaging Unit:</b> 1</p> <p><b>Model:</b> G3/60-5/6,1 Brazil</p>
<p><b>T45218</b></p> 	<p><b>Description:</b> SYNCHRO HUB (48-40T.)</p> <p><b>OEM No :</b> 970 262 2435</p> <p><b>EX / CROSS :</b> 694 262 0235 693 262 0035</p>	<p><b>Packaging Unit:</b> 1</p> <p><b>Model:</b> G60-6/9,20-1,00 G85-6/6,70-0,83 GO110-6/6,1-0,747</p>
<p><b>T08342</b></p> 	<p><b>Description:</b> SYNCHRO HUB (48-8T.)</p> <p><b>OEM No :</b> 381 262 0135</p> <p><b>EX / CROSS :</b></p>	<p><b>Packaging Unit:</b> 1</p> <p><b>Model:</b> G3/50-5/8,5 G3/60-5/6,1 G3/60-5/7,5 G3/61-5/6,1 G3/65-8/9,29 G3/65-9/13,36 G3/90-8/9,29 GO3/60-5/5,4 GO3/60-5/5,4 Turkey</p>
<p><b>T08346</b></p> 	<p><b>Description:</b> SYNCHRO HUB (48-8T.)</p> <p><b>OEM No :</b> 383 262 0235</p> <p><b>EX / CROSS :</b></p>	<p><b>Packaging Unit:</b> 1</p> <p><b>Model:</b> G3/50-5/8,5 G3/60-5/6,1 G3/60-5/7,5 G3/61-5/6,1 GO3/60-5/5,4 GO3/60-5/5,4 Turkey</p>



T08280



**Description:**  
SYNCHRO HUB (48-8T.)

**Packaging Unit:** 1

**OEM No :**  
302 262 0535

**Model:**  
G3/60-5/6,1  
G3/61-5/6,1  
GO3/60-5/5,4  
GO3/60-5/5,4 Turkey

**EX / CROSS :**

T45593



**Description:**  
SYNCHRO HUB (54-24T.)

**Packaging Unit:** 1

**OEM No :**  
695 262 0035

**Model:**  
G85-6/6,70-0,83  
GO110-6/6,1-0,747

**EX / CROSS :**

T45633



**Description:**  
SYNCHRO HUB (54-24T.)

**Packaging Unit:** 1

**OEM No :**  
976 262 0835

**Model:**  
G85-6/6,70-0,83

**EX / CROSS :**  
976 262 0935

T45183

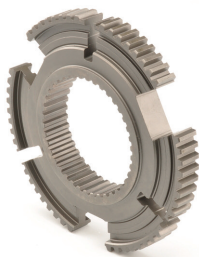

**Description:**  
SYNCHRO HUB (54-40T.)

**Packaging Unit:** 1

**OEM No :**  
970 262 2535

**Model:**  
G56-6  
G60-6/9,20-1,00  
G70-6  
G71-6  
G85-6/6,70-0,83  
G90-6  
GO110-6/6,1-0,747

**EX / CROSS :**  
974 262 0035  
694 262 0335

T68495



**Description:**  
SYNCHRO HUB (60-22T.)

**Packaging Unit:** 1

**OEM No :**  
947 262 0435

**Model:**  
G131-9  
G141-9

**EX / CROSS :**





T63705



**Description:**  
SYNCHRO HUB (60-22T.)

**Packaging Unit:** 1

**OEM No :**  
656 262 0335

**Model:**  
GO210-6/6,53-0,80

**EX / CROSS :**

T54698



**Description:**  
SYNCHRO HUB (60-22T.)

**Packaging Unit:** 1

**OEM No :**  
389 262 5335

**Model:**  
GO170-6/8,2-1,0  
GO190-6/8,2-1,0  
GO210-6/6,53-0,80  
GO230-6/6,5-0,8

**EX / CROSS :**

T69735



**Description:**  
SYNCHRO HUB (60-22T.)

**Packaging Unit:** 1

**OEM No :**  
656 262 0435

**Model:**  
GO210-6/6,53-0,80

**EX / CROSS :**

T58358



**Description:**  
SYNCHRO HUB (60-24T.)

**Packaging Unit:** 1

**OEM No :**  
945 262 3735

**Model:**  
G181-9  
G221-9/10,19-1,00

**EX / CROSS :**

945 262 1835-OLD

T68492







**Description:**  
SYNCHRO HUB (60-28T.)

**Packaging Unit:** 1

**OEM No :**  
947 262 0135

**Model:**  
G131-9  
G141-9

**EX / CROSS :**

<p><b>T14495</b></p> 	<p><b>Description:</b> SYNCHRO HUB (60-28T.)</p> <p><b>OEM No :</b> 389 262 0635</p> <p><b>EX / CROSS :</b></p> <p><b>Model:</b> G125-16/14,0 G135-16/11,9 G155-16/11,9 G155-16/14,0 G155-9/15,9 G180-16/11,9 G180-16/14,0 GO210-8/11,8</p>	<p><b>Packaging Unit:</b> 1</p>
<p><b>T51901</b></p> 	<p><b>Description:</b> SYNCHRO HUB (60-28T.)</p> <p><b>OEM No :</b> 970 262 1535</p> <p><b>EX / CROSS :</b> 970 262 1235</p>	<p><b>Packaging Unit:</b> 1</p> <p><b>Model:</b> G60-6/9,20-1,00</p>
<p><b>T17378</b></p> 	<p><b>Description:</b> SYNCHRO HUB (60-32T.)</p> <p><b>OEM No :</b> 389 262 2835</p> <p><b>EX / CROSS :</b></p>	<p><b>Packaging Unit:</b> 1</p> <p><b>Model:</b> G210-16/14,2-0,83 G240-16/11,72-0,69</p>
<p><b>T12342</b></p> 	<p><b>Description:</b> SYNCHRO HUB (66-28T.)</p> <p><b>OEM No :</b> 389 262 1535</p> <p><b>EX / CROSS :</b></p>	<p><b>Packaging Unit:</b> 1</p> <p><b>Model:</b> G155-16/11,9 G155-16/14,0 G180-16/11,9 G180-16/14,0 G200-16/11,9</p>
<p><b>T12281</b></p> 	<p><b>Description:</b> SYNCHRO HUB (66-32T.)</p> <p><b>OEM No :</b> 389 262 0035</p> <p><b>EX / CROSS :</b> 387 262 1735</p>	<p><b>Packaging Unit:</b> 1</p> <p><b>Model:</b> G125-16/14,0 G135-16/11,9 G155-16/11,9 G155-16/14,0 G155-9/15,9 G180-16/11,9 G180-16/14,0 G200-16/11,9 G4/65-7/11,0 GO210-8/11,8</p>

<p><b>T15543</b></p> 	<p><b>Description:</b> SYNCHRO HUB (66-32T.)</p> <p><b>OEM No :</b> 389 262 2535</p> <p><b>EX / CROSS :</b> 945 262 0135</p>	<p><b>Packaging Unit:</b> 1</p> <p><b>Model:</b> G181-9 G210-16/14,2-0,83 G211-16/17,03-1,0 G221-9/10,19-1,00 G230-16/14,2-0,83 G231-16/17,03-1,0 G240-16/11,72-0,69 G260-16/9,75-0,57</p>
<p><b>T15521</b></p> 	<p><b>Description:</b> SYNCHRO HUB (66-32T.)</p> <p><b>OEM No :</b> 389 262 4735</p> <p><b>EX / CROSS :</b> 389 262 4635</p>	<p><b>Packaging Unit:</b> 1</p> <p><b>Model:</b> G210-16/14,2-0,83 G211-16/17,03-1,0 G230-16/14,2-0,83 G231-16/17,03-1,0 G240-16/11,72-0,69 G260-16/9,75-0,57</p>
<p><b>T51697</b></p> 	<p><b>Description:</b> SYNCHRO HUB (72-34T.)</p> <p><b>OEM No :</b> 389 262 4435</p> <p><b>EX / CROSS :</b></p>	<p><b>Packaging Unit:</b> 1</p> <p><b>Model:</b> GO170-6/8,2-1,0 GO190-6/8,2-1,0 GO210-6/6,53-0,80 GO230-6/6,5-0,8 GO4/160-6/8,2</p>
<p><b>T18364</b></p> 	<p><b>Description:</b> SYNCHRO HUB (72-50T.)</p> <p><b>OEM No :</b> 389 262 0535</p> <p><b>EX / CROSS :</b></p>	<p><b>Packaging Unit:</b> 1</p> <p><b>Model:</b> G125-16/14,0 G135-16/11,9 G155-16/11,9 G155-16/14,0 G155-9/15,9 G180-16/11,9 G180-16/14,0 GO210-8/11,8</p>
<p><b>T12224</b></p> 	<p><b>Description:</b> SYNCHRO HUB (73-50T.)</p> <p><b>OEM No :</b> 389 262 4935</p> <p><b>EX / CROSS :</b> 389 262 2035</p>	<p><b>Packaging Unit:</b> 1</p> <p><b>Model:</b> G125-16/14,0 G131-9 G135-16/11,9 G141-9 G155-16/11,9 G155-16/14,0 G155-9/15,9 G180-16/11,9 G180-16/14,0 G181-9 G200-16/11,9 G210-16/14,2-0,83 G211-12 Klauen G211-16/17,03-1,0 G230-12 Klauen G230-16/14,2-0,83 G231-16/17,03-1,0 G241-16 Klauen G260-16/9,75-0,57 G280-16 Klauen G281-12 Klauen GO210-8/11,8</p>



**T56717**

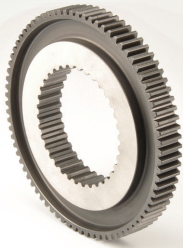

**Description:**  
SYNCHRO HUB (78-35T.)

**Packaging Unit:** 1

**OEM No :**  
389 262 5635

**Model:**  
GO170-6/8,2-1,0  
GO190-6/8,2-1,0  
GO210-6/6,53-0,80  
GO230-6/6,5-0,8  
GO4/160-6/8,2

**EX / CROSS :**  
389 262 3335

**T45595**



**Description:**  
SYNCHRO KIT 1ST-2ND SPEED

**Packaging Unit:** 1

**OEM No :**  
970 260 2844

**Model:**  
G60-6/9,20-1,00  
G85-6/6,70-0,83  
GO110-6/6,1-0,747

**EX / CROSS :**

**T67081**



**Description:**  
SYNCHRO KIT 1ST-2ND SPEED - MB G85

**Packaging Unit:** 1

**OEM No :**  
TAS67081

**Model:**  
G60-6/9,20-1,00  
G71-6  
G85-6/6,70-0,83  
G90-6  
GO110-6/6,1-0,747

**EX / CROSS :**

**T93522**



**Description:**  
SYNCHRO KIT 1ST-2ND SPEED GO210-6

**Packaging Unit:** 1

**OEM No :**  
TAS93522

**Model:**  
GO210-6/6,53-0,80

**EX / CROSS :**

**T45597**

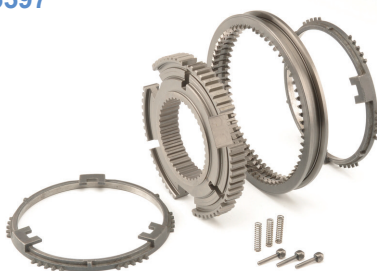

**Description:**  
SYNCHRO KIT 3RD-4TH SPEED

**Packaging Unit:** 1

**OEM No :**  
970 260 2944

**Model:**  
G60-6/9,20-1,00  
G71-6  
G85-6/6,70-0,83  
G90-6  
GO110-6/6,1-0,747

**EX / CROSS :**





T82730



**Description:**  
SYNCHRO KIT 3RD-4TH SPEED

**Packaging Unit:** 1

**OEM No :**  
TAS82730

**Model:**  
G155-16/11,9  
G155-16/14,0  
G180-16/11,9  
G180-16/14,0

**EX / CROSS :**

T67079



**Description:**  
SYNCHRO KIT 3RD-4TH SPEED - MB G85

**Packaging Unit:** 1

**OEM No :**  
TAS67079

**Model:**  
G56-6  
G60-6/9,20-1,00  
G70-6  
G71-6  
G85-6/6,70-0,83  
G90-6  
GO110-6/6,1-0,747  
UG100-8/9,57-0,7 GPA  
UNIMOG

**EX / CROSS :**

T93523



**Description:**  
SYNCHRO KIT 3RD-4TH SPEED GO210-6

**Packaging Unit:** 1

**OEM No :**  
TAS93523

**Model:**  
GO210-6/6,53-0,80

**EX / CROSS :**

T93524



**Description:**  
SYNCHRO KIT 5TH-6TH SPEED (1ST GEN) GO210-6

**Packaging Unit:** 1

**OEM No :**  
TAS93524

**Model:**  
GO210-6/6,53-0,80

**EX / CROSS :**

T93525



**Description:**  
SYNCHRO KIT 5TH-6TH SPEED (2ND GEN) GO210-6

**Packaging Unit:** 1

**OEM No :**  
TAS93525

**Model:**  
GO210-6/6,53-0,80

**EX / CROSS :**



**T93900**



**Description:**

SYNCHRO KIT 5TH-6TH SPEED GO190-6

**Packaging Unit:** 1

**OEM No :**

TAS93900

**Model:**

**EX / CROSS :**

**T93901**



**Description:**

SYNCHRO KIT 5TH-6TH SPEED GO190-6

**Packaging Unit:** 1

**OEM No :**

TAS93901

**Model:**

**EX / CROSS :**

**T69431**



**Description:**

SYNCHRO REPAIR KIT G210/G240

**Packaging Unit:** 1

**OEM No :**

TAS69431

**Model:**

G210-16/14,2-0,83  
G210-16/14,2-0,83 ESP  
G240-16/11,72-0,69  
G240-16/11,72-0,69 ESP

**EX / CROSS :**

**T45170**



**Description:**

SYNCHRO RING

**Packaging Unit:** 1

**OEM No :**

970 262 3034

**Model:**

G60-6/9,20-1,00  
G71-6  
G85-6/6,70-0,83  
G90-6  
GO110-6/6,1-0,747

**EX / CROSS :**

970 262 2834

970 262 0134

**T45181**



**Description:**

SYNCHRO RING

**Packaging Unit:** 1

**OEM No :**

970 262 3134

**Model:**

G56-6  
G60-6/9,20-1,00  
G70-6  
G71-6  
G85-6/6,70-0,83  
G90-6  
GO110-6/6,1-0,747  
UG100-8/9,57-0,7 GPA  
UNIMOG

**EX / CROSS :**





970 262 2934

970 262 1234



<p><b>T19036</b></p> 	<p><b>Description:</b> SYNCHRO RING</p> <p><b>OEM No :</b> 970 262 3537</p> <p><b>EX / CROSS :</b> 970 262 1937</p>	<p><b>Packaging Unit:</b> 1</p> <p><b>Model:</b> G56-6 G60-6/9,20-1,00 G70-6 G71-6 G85-6/6,70-0,83 G90-6 GO110-6/6,1-0,747 UG100-8/9,57-0,7 GPA UNIMOG</p>
<p><b>T68563</b></p> 	<p><b>Description:</b> SYNCHRO RING</p> <p><b>OEM No :</b> 675 262 0137</p> <p><b>EX / CROSS :</b></p>	<p><b>Packaging Unit:</b> 1</p> <p><b>Model:</b> G3/45-6/8,5 G3/50-5/8,5 G3/50-5/8,5 Brazil G3/55-6/8,5 G3/60-5/5,4 G3/60-5/7,5 G3/60-5/7,5 Brazil GO3/60-5/5,4 UG3/65-8/13,01 UNIMOG</p>
<p><b>T15581</b></p> 	<p><b>Description:</b> SYNCHRO RING</p> <p><b>OEM No :</b> 425 262 0137</p> <p><b>EX / CROSS :</b> 385 262 1537 385 262 0137</p>	<p><b>Packaging Unit:</b> 1</p> <p><b>Model:</b> G3/65-8/9,29 G3/65-9/13,36 G3/90-8/9,29 GO3/60-5/5,4 GO3/60-5/5,4 Turkey GO3/80-4/4,43 UG3/40-8/13,01 UNIMOG</p>
<p><b>T45178</b></p> 	<p><b>Description:</b> SYNCHRO RING</p> <p><b>OEM No :</b> 970 262 3437</p> <p><b>EX / CROSS :</b> 970 262 0237</p>	<p><b>Packaging Unit:</b> 1</p> <p><b>Model:</b> G60-6/9,20-1,00 G71-6 G85-6/6,70-0,83 G90-6 GO110-6/6,1-0,747</p>
<p><b>T51796</b></p> 	<p><b>Description:</b> SYNCHRO RING</p> <p><b>OEM No :</b> 972 262 0089</p> <p><b>EX / CROSS :</b> 972 262 0189 972 262 0289</p>	<p><b>Packaging Unit:</b> 1</p> <p><b>Model:</b> G56-6 G70-6 UG100-8/9,57-0,7 GPA UNIMOG</p>



<p><b>T08595</b></p> 	<p><b>Description:</b> SYNCHRO RING</p> <p><b>OEM No :</b> 381 262 0037</p> <p><b>EX / CROSS :</b> 302 262 0537</p>	<p><b>Packaging Unit:</b> 1</p> <p><b>Model:</b> G3/50-5/8,5 G3/50-5/8,5 Brazil G3/60-5/6,1 G3/60-5/7,5 G3/60-5/7,5 Brazil G3/61-5/6,1 G3/61-5/6,1 Brazil G03/60-5/5,4</p>
<p><b>T75667</b></p> 	<p><b>Description:</b> SYNCHRO RING</p> <p><b>OEM No :</b> 976 262 3234</p> <p><b>EX / CROSS :</b> 976 262 3034</p>	<p><b>Packaging Unit:</b> 1</p> <p><b>Model:</b> G70-6 G71-6 G90-6 UG100-8/9,57-0,7 GPA UNIMOG</p>
<p><b>T01157</b></p> 	<p><b>Description:</b> SYNCHRO RING (45T.)</p> <p><b>OEM No :</b> 322 262 0137</p> <p><b>EX / CROSS :</b></p>	<p><b>Packaging Unit:</b> 1</p> <p><b>Model:</b> G3/36-5/8,98 G3/40-5/7,5 G3/40-5/7,5 Indonesian G3/60-5/6,1 Brazil G3/70-4/4,24</p>
<p><b>T07561</b></p> 	<p><b>Description:</b> SYNCHRO RING (45T.)</p> <p><b>OEM No :</b> 322 262 0237</p> <p><b>EX / CROSS :</b></p>	<p><b>Packaging Unit:</b> 1</p> <p><b>Model:</b> G3/60-5/6,1 Brazil</p>
<p><b>T15274</b></p> 	<p><b>Description:</b> SYNCHRO RING (48T.)</p> <p><b>OEM No :</b> 385 262 1437</p> <p><b>EX / CROSS :</b> 385 262 0637</p>	<p><b>Packaging Unit:</b> 1</p> <p><b>Model:</b> G3/65-8/9,29 G3/65-9/13,36 G3/90-8/9,29 UG100-8/9,57-0,7 GPA UNIMOG UG3/40-8/13,01 UNIMOG UG3/65-8/13,01 UNIMOG</p>





<p><b>T45192</b></p>	<p><b>Description:</b> SYNCHRO RING (48T.)</p> <p><b>OEM No :</b> 970 262 3037</p> <p><b>EX / CROSS :</b> 970 262 1537 970 262 1437</p>	<p><b>Packaging Unit:</b> 1</p> <p><b>Model:</b> G56-6 G60-6/9,20-1,00 G70-6 G71-6 G85-6/6,70-0,83 G90-6 GO110-6/6,1-0,747 UG100-8/9,57-0,7 GPA UNIMOG</p>
<p><b>T19039</b></p>	<p><b>Description:</b> SYNCHRO RING (66T.)</p> <p><b>OEM No :</b> 970 262 3937</p> <p><b>EX / CROSS :</b> 970 262 3237 970 262 5937</p>	<p><b>Packaging Unit:</b> 1</p> <p><b>Model:</b> G56-6 G60-6/9,20-1,00 G70-6 G71-6 G85-6/6,70-0,83 G90-6 GO110-6/6,1-0,747 UG100-8/9,57-0,7 GPA UNIMOG</p>
<p><b>T19038</b></p>	<p><b>Description:</b> SYNCHRO RING (72T.)</p> <p><b>OEM No :</b> 970 262 3837</p> <p><b>EX / CROSS :</b> 970 262 6037</p>	<p><b>Packaging Unit:</b> 1</p> <p><b>Model:</b> G60-6/9,20-1,00 G71-6 G85-6/6,70-0,83 G90-6 GO110-6/6,1-0,747</p>
<p><b>T75553</b></p>	<p><b>Description:</b> SYNCHRO RING (CARBON FIBER)</p> <p><b>OEM No :</b> 972 262 0089 CB</p> <p><b>EX / CROSS :</b></p>	<p><b>Packaging Unit:</b> 1</p> <p><b>Model:</b> G56-6 G70-6</p>
<p><b>T75470</b></p>	<p><b>Description:</b> SYNCHRO RING (CARBON FIBER)</p> <p><b>OEM No :</b> 970 262 3034 CB</p> <p><b>EX / CROSS :</b></p>	<p><b>Packaging Unit:</b> 1</p> <p><b>Model:</b> G60-6/9,20-1,00 G85-6/6,70-0,83 G90-6 GO110-6/6,1-0,747</p>



T75458



**Description:**

SYNCHRO RING (CARBON FIBER)

**Packaging Unit:** 1

**OEM No :**

970 262 3134 CB

**Model:**

G56-6  
G60-6/9,20-1,00  
G70-6  
G85-6/6,70-0,83  
G90-6  
GO110-6/6,1-0,747

**EX / CROSS :**

T66545



**Description:**

SYNCHRO RING (CARBON FIBER)

**Packaging Unit:**

**OEM No :**

947 260 3045/RING

**Model:**

**EX / CROSS :**

T66552



**Description:**

SYNCHRO RING (CARBON FIBER)

**Packaging Unit:**

**OEM No :**

947 260 2845/RING

**Model:**

**EX / CROSS :**

T11712



**Description:**

SYNCHRO RING (MOLYBDENUM)

**Packaging Unit:** 1

**OEM No :**

389 262 0737/RING

**Model:**

**EX / CROSS :**

945 262 0137/RING  
387 262 1137/RING  
945 260 0650 MO/RING

T12204



**Description:**

SYNCHRO RING (MOLYBDENUM)

**Packaging Unit:** 1

**OEM No :**

389 262 0537/RING

**Model:**

**EX / CROSS :**

389 262 0137/RING  
389 262 0037/RING  
945 260 0850 MO/RING



<p><b>T12209</b></p> 	<p><b>Description:</b> SYNCHRO RING (MOLYBDENUM)</p> <p><b>OEM No :</b> 389 262 0637/RING</p> <p><b>EX / CROSS :</b> 389 262 1337/RING 389 262 2537/RING 945 260 0450 MO/RING</p>	<p><b>Packaging Unit:</b> 1</p> <p><b>Model:</b></p>
<p><b>T20573</b></p> 	<p><b>Description:</b> SYNCHRO RING (MOLYBDENUM)</p> <p><b>OEM No :</b> 946 262 6337/RING</p> <p><b>EX / CROSS :</b> 947 260 2845 MO/RING 945 260 2245 MO/RING 947 260 0545 MO/RING</p>	<p><b>Packaging Unit:</b> 1</p> <p><b>Model:</b></p>
<p><b>T45660</b></p> 	<p><b>Description:</b> SYNCHRO RING (MOLYBDENUM)</p> <p><b>OEM No :</b> 947 260 0945 MO/RING</p> <p><b>EX / CROSS :</b> 947 260 3045 MO/RING</p>	<p><b>Packaging Unit:</b> 1</p> <p><b>Model:</b></p>
<p><b>T70729</b></p> 	<p><b>Description:</b> SYNCHRO RING (MOLYBDENUM)</p> <p><b>OEM No :</b> 946 262 6137/RING</p> <p><b>EX / CROSS :</b></p>	<p><b>Packaging Unit:</b> 1</p> <p><b>Model:</b></p>
<p><b>T20997</b></p> 	<p><b>Description:</b> SYNCHRO RING W/SPRING (CARBON FIBER)</p> <p><b>OEM No :</b> 947 260 3045</p> <p><b>EX / CROSS :</b> 947 260 0945</p>	<p><b>Packaging Unit:</b> 1</p> <p><b>Model:</b></p> <p>G125-16/14,0 G131-9 G135-16/11,9 G141-9 G155-16/11,9 G155-16/14,0 G155-9/15,9 G180-16/11,9 G180-16/14,0 G181-9 G200-16/11,9 G210-16/14,2-0,83</p> <p>G211-12 Klauen G211-16/17,03-1,0 G230-12 Klauen G230-16/14,2-0,83 G231-16/17,03-1,0 G241-16 Klauen G260-16/9,75-0,57 G280-16 Klauen G281-12 Klauen GO210-8/11,8</p>

**T57222**



**Description:**

SYNCHRO RING W/SPRING (CARBON FIBER)

**Packaging Unit:** 1

**OEM No :**

947 260 4645

**Model:**

G181-9  
G211-16/17,03-1,0  
G231-16/17,03-1,0  
G241-16 Klauen  
G260-16/9,75-0,57  
G280-16 Klauen  
G281-12 Klauen  
GO240-8/6,57-0,63  
GO250-8/6,57-0,63

**EX / CROSS :**

947 260 3545

947 260 2945

947 260 1945

947 260 0745

**T69103**



**Description:**

SYNCHRO RING W/SPRING (CARBON FIBER)

**Packaging Unit:** 1

**OEM No :**

947 260 2845

**Model:**

G210-16/14,2-0,83  
G211-12 Klauen  
G211-16/17,03-1,0  
G221-9/10,19-1,00  
G230-12 Klauen  
G230-16/14,2-0,83  
G231-16/17,03-1,0  
G240-16/11,72-0,69  
GO210-6/6,53-0,80

**EX / CROSS :**

947 260 0545

945 260 2245

**T88628**



**Description:**

SYNCHRO RING W/SPRING (MOLYBDENUM)

**Packaging Unit:** 1

**OEM No :**

389 262 0537

**Model:**

G125-16/14,0  
G131-9  
G135-16/11,9  
G155-16/11,9  
G155-16/14,0  
G155-9/15,9  
G180-16/11,9  
G180-16/14,0  
G181-9  
G200-16/11,9  
G210-16/14,2-0,83  
G211-16/17,03-1,0  
G221-9/10,19-1,00  
G230-16/14,2-0,83  
G231-16/17,03-1,0  
G240-16/11,72-0,69  
G241-16 Klauen  
G260-16/9,75-0,57  
G280-16 Klauen  
GO210-8/11,8

**EX / CROSS :**

389 262 0037

389 262 0137

945 260 0850 MO

**T88629**



**Description:**

SYNCHRO RING W/SPRING (MOLYBDENUM)

**Packaging Unit:** 1

**OEM No :**

947 260 3045 MO

**Model:**

G125-16/14,0  
G131-9  
G135-16/11,9  
G141-9  
G155-16/11,9  
G155-16/14,0  
G155-9/15,9  
G180-16/11,9  
G180-16/14,0  
G181-9  
G200-16/11,9  
G210-16/14,2-0,83  
G211-12 Klauen  
G211-16/17,03-1,0  
G230-12 Klauen  
G230-16/14,2-0,83  
G231-16/17,03-1,0  
G241-16 Klauen  
G260-16/9,75-0,57  
G280-16 Klauen  
G281-12 Klauen  
GO210-8/11,8

**EX / CROSS :**

947 260 0945 MO

**T70725**



**Description:**

SYNCHRO RING W/SPRING (MOLYBDENUM)

**Packaging Unit:** 1

**OEM No :**

946 262 6137

**Model:**

G221-9/10,19-1,00  
G240-16/11,72-0,69  
G330-12/11,64-0,78  
GO210-6/6,53-0,80

**EX / CROSS :**

947 260 2945 MO

947 260 0745 MO

947 260 1945 MO

947 260 3545 MO



**T84072**



**Description:**

SYNCHRO RING W/SPRING (MOLYBDENUM)

**Packaging Unit:** 1

**OEM No :**

947 260 0545 MO

**Model:**

**EX / CROSS :**

947 260 2845 MO

945 260 2245 MO

946 262 6337

**T88630**



**Description:**

SYNCHRO RING W/SPRING (MOLYBDENUM)

**Packaging Unit:** 1

**OEM No :**

389 262 0737

**Model:**

**EX / CROSS :**

389 262 1137

389 262 1437

389 262 2737

389 262 3237-OLD

**T88631**



**Description:**

SYNCHRO RING W/SPRING (MOLYBDENUM)

**Packaging Unit:** 1

**OEM No :**

389 262 0637

**Model:**

**EX / CROSS :**

389 262 2537

389 262 1337

389 262 2437

389 262 3137-OLD

**T68586**



**Description:**

SYNCHRO SLIDING SLEEVE

**Packaging Unit:** 1

**OEM No :**

381 262 0223

**Model:**

G3/45-6/8,5  
G3/50-5/8,5  
G3/50-5/8,5 Brazil  
G3/55-6/8,5  
G3/60-5/5,4  
G3/60-5/7,5  
G3/60-5/7,5 Brazil  
GO3/60-5/5,4  
UG3/65-8/13,01 UNIMOG

**EX / CROSS :**

381 262 0523

**T94344**



**Description:**

SYNCHRO SLIDING SLEEVE

**Packaging Unit:** 1

**OEM No :**





656 262 0023

**Model:**

GO240-8/6,57-0,63  
GO250-8/6,57-0,63

**EX / CROSS :**

656 262 1123

<p><b>T39257</b></p> 	<p><b>Description:</b> SYNCHRO SLIDING SLEEVE</p> <p><b>OEM No :</b> 389 264 0223</p> <p><b>EX / CROSS :</b></p>	<p><b>Packaging Unit:</b> 1</p> <p><b>Model:</b> G211-16/17,03-1,0 G231-16/17,03-1,0 G260-16/9,75-0,57</p>
<p><b>T50815</b></p> 	<p><b>Description:</b> SYNCHRO SLIDING SLEEVE</p> <p><b>OEM No :</b> 947 262 1123</p> <p><b>EX / CROSS :</b> 947 262 0423 947 262 1423 947 262 2223</p>	<p><b>Packaging Unit:</b> 1</p> <p><b>Model:</b> G140-8 G211-12 Klauen G230-12 Klauen</p>
<p><b>T94354</b></p> 	<p><b>Description:</b> SYNCHRO SLIDING SLEEVE</p> <p><b>OEM No :</b> 656 262 0823</p> <p><b>EX / CROSS :</b> 656 262 0523 656 262 0323</p>	<p><b>Packaging Unit:</b> 1</p> <p><b>Model:</b> GO240-8/6,57-0,63</p>
<p><b>T44646</b></p> 	<p><b>Description:</b> SYNCHRO SLIDING SLEEVE</p> <p><b>OEM No :</b> 945 262 0323/M</p> <p><b>EX / CROSS :</b></p>	<p><b>Packaging Unit:</b> 1</p> <p><b>Model:</b></p>
<p><b>T44645</b></p> 	<p><b>Description:</b> SYNCHRO SLIDING SLEEVE</p> <p><b>OEM No :</b> 389 262 2923/M</p> <p><b>EX / CROSS :</b></p>	<p><b>Packaging Unit:</b> 1</p> <p><b>Model:</b></p>



T44647



**Description:**  
SYNCHRO SLIDING SLEEVE

**Packaging Unit:** 1

**OEM No :**  
945 262 0423/M

**Model:**

**EX / CROSS :**

T55350



**Description:**  
SYNCHRO SLIDING SLEEVE

**Packaging Unit:** 1

**OEM No :**  
945 262 2123

**Model:**  
G221-9/10,19-1,00

**EX / CROSS :**

T75567



**Description:**  
SYNCHRO SLIDING SLEEVE

**Packaging Unit:** 1

**OEM No :**  
971 262 1323

**Model:**  
G56-6  
G70-6  
G71-6  
G90-6

**EX / CROSS :**  
971 262 0323  
972 262 0523

T50812



**Description:**  
SYNCHRO SLIDING SLEEVE (30T.)

**Packaging Unit:** 1

**OEM No :**  
930 262 0123

**Model:**  
G140-8  
G241-16 Klauen  
G280-16 Klauen  
G281-12 Klauen  
G330-12/11,64-0,78

**EX / CROSS :**  
945 262 5223  
930 262 0723  
960 262 1523

T12221







**Description:**  
SYNCHRO SLIDING SLEEVE (37T.)

**Packaging Unit:** 1

**OEM No :**  
389 262 0223

**Model:**  
G155-9/15,9

**EX / CROSS :**

<p><b>T15541</b></p> 	<p><b>Description:</b> SYNCHRO SLIDING SLEEVE (37T.)</p> <p><b>Packaging Unit:</b> 1</p> <p><b>OEM No :</b> 389 262 1823</p> <p><b>Model:</b> G125-16/14,0 G135-16/11,9 G155-16/11,9 G155-16/14,0 G180-16/11,9 G180-16/14,0 G200-16/11,9 G210-16/14,2-0,83 G211-16/17,03-1,0 G230-16/14,2-0,83 G231-16/17,03-1,0 G240-16/11,72-0,69</p> <p><b>EX / CROSS :</b> 389 262 0923</p> <p><b>Model:</b> G241-16 Klauen G260-16/9,75-0,57 G280-16 Klauen GO190-6/8,2-1,0 GO210-6/6,53-0,80 GO210-8/11,8 GO230-6/6,5-0,8 GO4/160-6/8,2</p>
<p><b>T12208</b></p> 	<p><b>Description:</b> SYNCHRO SLIDING SLEEVE (37T.)</p> <p><b>Packaging Unit:</b> 1</p> <p><b>OEM No :</b> 389 262 1723</p> <p><b>Model:</b> G100-12 G125-16/14,0 G135-16/11,9 G155-16/11,9 G155-16/14,0 G180-16/11,9 G180-16/14,0 G200-16/11,9 G210-16/14,2-0,83 G211-16/17,03-1,0 G230-16/14,2-0,83 G231-16/17,03-1,0</p> <p><b>EX / CROSS :</b> 389 262 0023</p> <p><b>Model:</b> G240-16/11,72-0,69 G260-16/9,75-0,57 GO170-6/8,2-1,0 GO190-6/8,2-1,0 GO210-6/6,53-0,80 GO230-6/6,5-0,8 GO4/160-6/8,2</p>
<p><b>T55333</b></p> 	<p><b>Description:</b> SYNCHRO SLIDING SLEEVE (37T.)</p> <p><b>Packaging Unit:</b> 1</p> <p><b>OEM No :</b> 945 262 2023</p> <p><b>Model:</b> G131-9 G141-9 G181-9 G221-9/10,19-1,00</p> <p><b>EX / CROSS :</b></p>
<p><b>T08305</b></p> 	<p><b>Description:</b> SYNCHRO SLIDING SLEEVE (42T.)</p> <p><b>Packaging Unit:</b> 1</p> <p><b>OEM No :</b> 314 262 1223</p> <p><b>Model:</b> G2/24-5/6,2 G2/24-5/6,71 G2/24-5/6,71 Brazil G2/24-5/7,31 G2/24-5/7,31 Brazil G2/27-5/6,17 G2/27-5/6,2 G2/27-5/7,36</p> <p><b>EX / CROSS :</b> 314 262 1123</p>
<p><b>T08323</b></p> 	<p><b>Description:</b> SYNCHRO SLIDING SLEEVE (45T.)</p> <p><b>Packaging Unit:</b> 1</p> <p><b>OEM No :</b> 337 262 0223</p> <p><b>Model:</b> G3/60-5/6,1 Brazil</p> <p><b>EX / CROSS :</b> 337 262 0023</p>





**Description:** SYNCHRO SLIDING SLEEVE (45T.) **Packaging Unit:** 1

**OEM No :** 321 262 1123 **Model:** G3/36-5/8,98  
G3/40-5/7,5  
G3/40-5/7,5 Indonesian  
G3/60-5/6,1 Brazil

**EX / CROSS :** 321 262 0723



**Description:** SYNCHRO SLIDING SLEEVE (45T.) **Packaging Unit:** 1

**OEM No :** 321 262 1223 **Model:** G3/36-5/8,98  
G3/40-5/7,5  
G3/40-5/7,5 Indonesian  
G3/60-5/6,1 Brazil  
G3/70-4/4,24

**EX / CROSS :** 321 262 0823



**Description:** SYNCHRO SLIDING SLEEVE (48T.) **Packaging Unit:** 1

**OEM No :** 385 262 0923 **Model:** G3/65-8/9,29  
G3/65-9/13,36  
G3/90-8/9,29  
UG100-8/9,57-0,7 GPA  
UNIMOG  
UG3/40-8/13,01 UNIMOG  
UG3/65-8/13,01 UNIMOG

**EX / CROSS :**



**Description:** SYNCHRO SLIDING SLEEVE (48T.) **Packaging Unit:** 1

**OEM No :** 383 262 0023 **Model:** G3/50-5/8,5  
G3/50-5/8,5 Brazil  
G3/60-5/6,1  
G3/60-5/7,5  
G3/60-5/7,5 Brazil  
G3/61-5/6,1  
G3/61-5/6,1 Brazil  
GO3/60-5/5,4  
GO3/60-5/5,4 Turkey





**EX / CROSS :**







**Description:** SYNCHRO SLIDING SLEEVE (48T.) **Packaging Unit:** 1





**OEM No :** 381 262 0023 **Model:** G3/50-5/8,5  
G3/50-5/8,5 Brazil  
G3/60-5/6,1  
G3/60-5/7,5  
G3/60-5/7,5 Brazil  
G3/61-5/6,1  
G3/61-5/6,1 Brazil  
G3/65-8/9,29  
G3/65-9/13,36  
G3/90-8/9,29  
GO3/60-5/5,4  
GO3/60-5/5,4 Turkey

**EX / CROSS :** 307 262 0023 **Model:** GO3/80-4/4,43  
UG3/40-8/13,01 UNIMOG





<p><b>T45174</b></p> 	<p><b>Description:</b> SYNCHRO SLIDING SLEEVE (57T.)</p> <p><b>Packaging Unit:</b> 1</p> <p><b>OEM No :</b> 970 262 3323</p> <p><b>EX / CROSS :</b> 975 262 0223</p> <p>970 262 3723 694 262 0023</p> <p><b>Model:</b> G60-6/9,20-1,00 G71-6 G85-6/6,70-0,83 G90-6 GO110-6/6,1-0,747</p>
<p><b>T19309</b></p> 	<p><b>Description:</b> SYNCHRO SLIDING SLEEVE (60T.)</p> <p><b>Packaging Unit:</b> 1</p> <p><b>OEM No :</b> 945 262 6823</p> <p><b>EX / CROSS :</b> 945 262 6423</p> <p><b>Model:</b> G131-9 G141-9 G181-9 G210-16/14,2-0,83 G211-12 Klauen G211-16/17,03-1,0 G221-9/10,19-1,00 G230-12 Klauen G230-16/14,2-0,83 G231-16/17,03-1,0 G240-16/11,72-0,69 G260-16/9,75-0,57</p> <p>GO170-6/8,2-1,0 GO190-6/8,2-1,0 GO210-6/6,53-0,80 GO230-6/6,5-0,8</p>
<p><b>T45200</b></p> 	<p><b>Description:</b> SYNCHRO SLIDING SLEEVE (60T.)</p> <p><b>Packaging Unit:</b> 1</p> <p><b>OEM No :</b> 970 262 2923</p> <p><b>EX / CROSS :</b> 975 262 0123 970 262 2023 972 262 2023 970 262 2123</p> <p><b>Model:</b> G60-6/9,20-1,00 G85-6/6,70-0,83 GO110-6/6,1-0,747</p>
<p><b>T12220</b></p> 	<p><b>Description:</b> SYNCHRO SLIDING SLEEVE (60T.)</p> <p><b>Packaging Unit:</b> 1</p> <p><b>OEM No :</b> 389 262 3023</p> <p><b>EX / CROSS :</b> 389 262 2223 389 262 0623</p> <p><b>Model:</b> G125-16/14,0 G135-16/11,9 G155-16/11,9 G155-16/14,0 G155-9/15,9 G180-16/11,9 G180-16/14,0 G200-16/11,9 GO210-8/11,8</p>
<p><b>T12201</b></p> 	<p><b>Description:</b> SYNCHRO SLIDING SLEEVE (60T.)</p> <p><b>Packaging Unit:</b> 1</p> <p><b>OEM No :</b> 387 262 1523</p> <p><b>EX / CROSS :</b> 387 262 0523 387 262 0223</p> <p><b>Model:</b> G155-16/11,9 G155-16/14,0 G180-16/11,9 G180-16/14,0 G4/110-6/9,0 G4/65-6/9,0 G4/65-7/11,0 G4/95-6/9,0 G4/95-7/11,0 GO4/105-6/7,18 GO4/110-5/5,1 GO4/120-6/7,18</p> <p>GO4/130-6/7,18 GO4/160-6/7,18 GO4/95-5/5,1 GV4/110-6/9,0 GV4/65-6/9,0 GV4/95-6/9,0</p>

<p><b>T15317</b></p> 	<p><b>Description:</b> SYNCHRO SLIDING SLEEVE (60T.)</p> <p><b>OEM No :</b> 945 262 0323</p> <p><b>EX / CROSS :</b> 945 262 2823 389 262 1323 389 262 2723 389 262 4123</p>	<p><b>Packaging Unit:</b> 1</p> <p><b>Model:</b></p>
<p><b>T12218</b></p> 	<p><b>Description:</b> SYNCHRO SLIDING SLEEVE (66T.)</p> <p><b>OEM No :</b> 389 262 2923</p> <p><b>EX / CROSS :</b> 389 262 0723</p>	<p><b>Packaging Unit:</b> 1</p> <p><b>Model:</b> G125-16/14,0 G135-16/11,9 G155-16/11,9 G155-16/14,0 G155-9/15,9 G180-16/11,9 G180-16/14,0 G200-16/11,9 GO210-8/11,8</p>
<p><b>T18882</b></p> 	<p><b>Description:</b> SYNCHRO SLIDING SLEEVE (66T.)</p> <p><b>OEM No :</b> 945 262 6523</p> <p><b>EX / CROSS :</b> 930 262 0523</p>	<p><b>Packaging Unit:</b> 1</p> <p><b>Model:</b> G140-8 G181-9 G210-16/14,2-0,83 G211-16/17,03-1,0 G221-9/10,19-1,00 G230-16/14,2-0,83 G231-16/17,03-1,0 G240-16/11,72-0,69 G241-16 Klauen G260-16/9,75-0,57 G280-16 Klauen G281-12 Klauen G330-12/11,64-0,78 GO240-8/6,57-0,63 GO250-8/6,57-0,63</p>
<p><b>T15654</b></p> 	<p><b>Description:</b> SYNCHRO SLIDING SLEEVE (66T.)</p> <p><b>OEM No :</b> 387 262 0623</p> <p><b>EX / CROSS :</b></p>	<p><b>Packaging Unit:</b> 1</p> <p><b>Model:</b> G125-16/14,0 G135-16/11,9 G155-16/11,9 G155-16/14,0 G180-16/11,9 G180-16/14,0 G4/110-6/9,0 G4/65-6/9,0 G4/65-7/11,0 G4/95-6/9,0 G4/95-7/11,0 GO4/105-6/7,18 GO4/110-5/5,1 GO4/120-6/7,18 GO4/130-6/7,18 GO4/160-6/7,18 GO4/95-5/5,1 GV4/110-6/9,0 GV4/65-6/9,0 GV4/95-6/9,0</p>
<p><b>T12310</b></p> 	<p><b>Description:</b> SYNCHRO SLIDING SLEEVE (66T.)</p> <p><b>OEM No :</b> 945 262 2723</p> <p><b>EX / CROSS :</b> 945 262 0423 389 262 1223 389 262 2623</p>	<p><b>Packaging Unit:</b> 1</p> <p><b>Model:</b></p>



<p><b>T45187</b></p> 	<p><b>Description:</b> SYNCHRO SLIDING SLEEVE (66T.)</p> <p><b>Packaging Unit:</b> 1</p> <p><b>OEM No :</b> 970 262 3423</p> <p><b>EX / CROSS :</b> 975 262 0023 694 262 0123 970 262 3023 970 262 2944</p> <p><b>Model:</b> G60-6/9,20-1,00 G71-6 G85-6/6,70-0,83 G90-6 GO110-6/6,1-0,747</p>
<p><b>T17600</b></p> 	<p><b>Description:</b> SYNCHRO SLIDING SLEEVE (72T.)</p> <p><b>Packaging Unit:</b> 1</p> <p><b>OEM No :</b> 389 262 1523</p> <p><b>EX / CROSS :</b> 389 262 0123</p> <p><b>Model:</b> G125-16/14,0 G135-16/11,9 G155-16/11,9 G155-16/14,0 G155-9/15,9 G180-16/11,9 G180-16/14,0 GO210-8/11,8</p>
<p><b>T44040</b></p> 	<p><b>Description:</b> SYNCHRO SLIDING SLEEVE (72T.)</p> <p><b>Packaging Unit:</b> 1</p> <p><b>OEM No :</b> 389 262 2023</p> <p><b>EX / CROSS :</b></p> <p><b>Model:</b> GO170-6/8,2-1,0 GO190-6/8,2-1,0 GO210-6/6,53-0,80 GO230-6/6,5-0,8 GO4/160-6/8,2</p>
<p><b>T51701</b></p> 	<p><b>Description:</b> SYNCHRO SLIDING SLEEVE (72T.)</p> <p><b>Packaging Unit:</b> 1</p> <p><b>OEM No :</b> 945 262 5723</p> <p><b>EX / CROSS :</b></p> <p><b>Model:</b> GO170-6/8,2-1,0 GO190-6/8,2-1,0 GO210-6/6,53-0,80 GO230-6/6,5-0,8</p>
<p><b>T12237</b></p> 	<p><b>Description:</b> SYNCHRO SLIDING SLEEVE (73T.)</p> <p><b>Packaging Unit:</b> 1</p> <p><b>OEM No :</b> 945 262 6623</p> <p><b>EX / CROSS :</b> 945 262 0823 945 262 2623</p> <p><b>Model:</b></p>

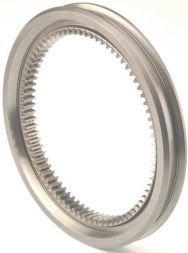

<p><b>T18883</b></p> 	<p><b>Description:</b> SYNCHRO SLIDING SLEEVE (73T.)</p> <p><b>OEM No :</b> 945 262 6923</p> <p><b>EX / CROSS :</b> 930 262 0623</p> <p><b>Model:</b> G125-16/14,0 G131-9 G135-16/11,9 G141-9 G155-16/11,9 G155-16/14,0 G155-9/15,9 G180-16/11,9 G180-16/14,0 G181-9 G200-16/11,9 G210-16/14,2-0,83</p>	<p><b>Packaging Unit:</b> 1</p> <p>G211-12 Klauen G211-16/17,03-1,0 G221-9/10,19-1,00 G230-12 Klauen G230-16/14,2-0,83 G231-16/17,03-1,0 G240-16/11,72-0,69 G241-16 Klauen G260-16/9,75-0,57 G280-16 Klauen G281-12 Klauen G330-12/11,64-0,78</p>
<p><b>T51699</b></p> 	<p><b>Description:</b> SYNCHRO SLIDING SLEEVE (78T.)</p> <p><b>OEM No :</b> 945 262 5623</p> <p><b>EX / CROSS :</b></p> <p><b>Model:</b> GO170-6/8,2-1,0 GO190-6/8,2-1,0 GO210-6/6,53-0,80 GO230-6/6,5-0,8</p>	<p><b>Packaging Unit:</b> 1</p>
<p><b>T44038</b></p> 	<p><b>Description:</b> SYNCHRO SLIDING SLEEVE (78T.)</p> <p><b>OEM No :</b> 389 262 2123</p> <p><b>EX / CROSS :</b></p> <p><b>Model:</b> GO170-6/8,2-1,0 GO190-6/8,2-1,0 GO210-6/6,53-0,80 GO230-6/6,5-0,8 GO4/160-6/8,2</p>	<p><b>Packaging Unit:</b> 1</p>
<p><b>T20574</b></p> 	<p><b>Description:</b> T/M CLUTCH SHAFT (10 SPLINES)</p> <p><b>OEM No :</b> 387 252 0208</p> <p><b>EX / CROSS :</b></p> <p><b>Model:</b></p>	<p><b>Packaging Unit:</b> 1</p>
<p><b>T12306</b></p> 	<p><b>Description:</b> T/M PLANETARY REDUCTION GEAR (26T.)</p> <p><b>OEM No :</b> 389 262 0806</p> <p><b>EX / CROSS :</b></p> <p><b>Model:</b></p>	<p><b>Packaging Unit:</b> 1</p>



**T70694**

**Description:**

TAPERED ROLLER BEARING

**Packaging Unit:** 1

**OEM No :**  
016 981 1505

**Model:**

**EX / CROSS :**  
016 981 0705  
016 981 0605  
016 981 0505  
016 981 0405



**T56291**

**Description:**

TAPERED ROLLER BEARING (100X150X32)

**Packaging Unit:** 1

**OEM No :**  
001 981 7205

**Model:**

**EX / CROSS :**  
017 981 7905  
006 981 5505  
006 981 0405  
004 981 7405



**T81544**

**Description:**

TAPERED ROLLER BEARING (100X150X39)

**Packaging Unit:** 1

**OEM No :**  
005 981 8505

**Model:**

**EX / CROSS :**  
386 981 0105  
014 981 3205  
006 981 0105  
005 981 8405

HD 4/02 DG-10  
HD 4/02 DG-10 BRAZIL  
HD 4/02 GD-10  
HD 4/03 D-10  
HD 4/03 D-10 BRAZIL  
HH 4/04 D-12  
HH 4/05 D-10 BRAZIL  
HH 4/07 DL-10 BRAZIL  
HL 4/01 - 10  
HL 4/01 D-10  
HL 4/01 D-10 BRAZIL  
HL 4/01 DL-10  
HL 4/01 DL-11,5  
HL 4/01 L-10  
HL 4/01-10  
HL 4/035 D-10,6  
HL 4/038 D-10  
HL 4/038 D-12  
HL 4/038 D-9,4  
HL 4/039 D-10  
HL 4/039 D-12  
HL 4/039 DL-12  
HL 4/06 D-12  
HL 4/06 DL-12



**T54147**

**Description:**

TAPERED ROLLER BEARING (100X180X37)

**Packaging Unit:** 1

**OEM No :**  
004 981 2105

**Model:**

**EX / CROSS :**  
004 981 4905  
007 981 0005

HD 7/016 DG-13  
HD 7/016 DSG-13  
HD 7/19 DG-13  
HD 7/19 DG-13 TURKEY  
HD 7/19 DGS-13  
HD 7/19 DGS-13 TURKEY  
HD 7/19 DSG-13  
HL 7/015 D-13  
HL 7/015 D-13 TURKEY  
HL 7/015 DL-13  
HL 7/015 DS-13  
HL 7/07 DL-10  
HL 7/18 D-13  
HL 7/18 DS-13  
HL 7/18 DS-13 TURKEY



**T56273**

**Description:**

TAPERED ROLLER BEARING (105X160X43)

**Packaging Unit:** 1

**OEM No :**  
005 981 4905

**Model:**

**EX / CROSS :**  
003 981 2805  
003 981 2605  
000 980 9702  
000 352 0114

HD 7/09 DG-10  
HD 7/2 DG-10  
HD 7/2 DLG-10  
HD 7/2 DSG-10  
HD 7/5 DG-10  
HL 7/015 D-13  
HL 7/02 DL-10  
HL 7/021 D-10  
HL 7/021 DL-10  
HL 7/021 DS-10  
HL 7/024 D-12,3  
HL 7/024 DL-12,3  
HL 7/050 DCS-11,5  
HL 7/07 D-10  
HL 7/07 D-11,5  
HL 7/07 DL-10  
HL 7/07 DL-11,5  
HL 7/07 DS-10  
HL 7/1 D-10  
HL 7/1 DL-10  
HL 7/1 L-10  
HL 7/1 S-10  
HL 7/1-10  
HL 7/10 D-9

T94111



**Description:**

**Packaging Unit:** 1

TAPERED ROLLER BEARING (105X170X38)

**OEM No :**  
007 981 0305

**Model:**  
NG-MK-SK BUS O300-O400

**EX / CROSS :**  
004 981 0605  
003 981 6805

T37944



**Description:**

**Packaging Unit:** 1

TAPERED ROLLER BEARING (109,5X76,2X19,05)

**OEM No :**  
015 981 2605

**Model:**

**EX / CROSS :**

T54160



**Description:**

**Packaging Unit:** 1

TAPERED ROLLER BEARING (110X170X47)

**OEM No :**  
004 981 0905

**Model:**  
HD 7/014 DG-16  
HD 7/014 DGS-16  
HD 7/014 DGS-16 TURKEY  
HD 7/016 DG-13  
HD 7/016 DSG-13  
HD 7/055 DCGS-13  
HD 7/056 DGS-13  
HD 7/056 DGS-16  
HD 7/19 DG-13  
HD 7/19 DG-13 TURKEY  
HD 7/19 DGS-13  
HD 7/19 DGS-13 TURKEY

HD 7/19 DSG-13  
HD 7/55 DCGS-13  
HD 7/56 DGS-13  
HL 6/1 DC(L,S)-13  
(REINFORCED)  
HL 6/1 DC(LC)-13 (OLD  
VERSION)  
HL 6/1 DC(LC)-13  
(REINFORCED)  
HL 6/3 DC(L,S)-13 (OLD  
VERSION)  
HL 7/013 D-16  
HL 7/013 DS-16 TURKEY

**EX / CROSS :**

T84240



**Description:**

**Packaging Unit:** 1

TAPERED ROLLER BEARING (30,16X68,26X22,23)

**OEM No :**  
007 981 5305

**Model:**

**EX / CROSS :**

T75625



**Description:**

**Packaging Unit:** 1

TAPERED ROLLER BEARING (35X80X22,75)

**OEM No :**  
016 981 7305

**Model:**  
G56-6  
G70-6

**EX / CROSS :**  
016 981 3005  
016 981 3105



**T37921**



**Description:**

TAPERED ROLLER BEARING (38,10X65,08X18,03)

**Packaging Unit:** 1

**OEM No :**

002 980 4802

**Model:**

**EX / CROSS :**

**T38385**



**Description:**

TAPERED ROLLER BEARING (38,1X29,77)

**Packaging Unit:** 1

**OEM No :**

013 981 0305

**Model:**

G100-12

**EX / CROSS :**

**T52217**



**Description:**

TAPERED ROLLER BEARING (39,69X40,39)

**Packaging Unit:** 1

**OEM No :**

017 981 1305

**Model:**

G181-9  
G211-12 Klauen  
G211-16/17,03-1,0  
G221-9/10,19-1,00  
G230-12 Klauen  
G231-16/17,03-1,0  
G241-16 Klauen  
G280-16 Klauen  
G281-12 Klauen  
G330-12/11,64-0,78

**EX / CROSS :**

EC43994S01

**T55470**



**Description:**

TAPERED ROLLER BEARING (39,69X43,05)

**Packaging Unit:** 1

**OEM No :**

015 981 1705

**Model:**

G221-9/10,19-1,00  
GO240-8/6,57-0,63  
GO250-8/6,57-0,63

**EX / CROSS :**

014 981 8805

021 981 2205

**T22645**



**Description:**

TAPERED ROLLER BEARING (39,7X40,4)

**Packaging Unit:** 1

**OEM No :**

015 981 1605

**Model:**

G210-16/14,2-0,83  
G221-9/10,19-1,00  
G230-16/14,2-0,83  
G231-16/17,03-1,0  
G240-16/11,72-0,69  
G260-16/9,75-0,57  
GO170-6/8,2-1,0  
GO190-6/8,2-1,0  
GO210-6/6,53-0,80  
GO230-6/6,5-0,8  
GO4/160-6/8,2

**EX / CROSS :**

013 981 1105

013 981 0505

012 981 8205

012 981 8105





**T39607**



**Description:**

TAPERED ROLLER BEARING (39,98X90,97X32)

**Packaging Unit: 1**

**OEM No :**

008 981 2805

**Model:**

**EX / CROSS :**

**T75632**



**Description:**

TAPERED ROLLER BEARING (40X80X24,75)

**Packaging Unit: 1**

**OEM No :**

016 981 7205

**Model:**

**EX / CROSS :**

015 981 3405

015 981 3805

015 981 5605

**T84239**



**Description:**

TAPERED ROLLER BEARING (41,28X88,90X30,16)

**Packaging Unit: 1**

**OEM No :**

001 980 6902

**Model:**

HL O/01 C-3,2  
HL O/14 C-1,7  
HL O/15 C-2,2  
HL O/2-2,2  
HL O/3-3,3

**EX / CROSS :**

001 981 0005

005 981 2405

005 981 2505

000 981 6005

**T38395**



**Description:**

TAPERED ROLLER BEARING (45,98X18)

**Packaging Unit: 1**

**OEM No :**

013 981 0405

**Model:**

G100-12

**EX / CROSS :**

**T55902**



**Description:**

TAPERED ROLLER BEARING (45X100X27,25)

**Packaging Unit: 1**

**OEM No :**

010 981 6305

**Model:**

G125-16/14,0  
G135-16/11,9  
G4/65-6/9,0  
G4/65-7/11,0  
G4/95-7/11,0  
GV4/65-6/9,0

**EX / CROSS :**

010 981 5905

009 981 0305

006 981 5405

006 981 4205

**T52390**



**Description:**

TAPERED ROLLER BEARING (45X110X29)

**Packaging Unit:** 1

**OEM No :**

012 981 3605

**Model:**

GO170-6/8,2-1,0  
GO190-6/8,2-1,0  
GO210-6/6,53-0,80  
GO230-6/6,5-0,8  
GO240-8/6,57-0,63  
GO250-8/6,57-0,63  
GO4/160-6/8,2

**EX / CROSS :**

JXC25690 C/JXC25690

**T38391**



**Description:**

TAPERED ROLLER BEARING (45X30,04)

**Packaging Unit:** 1

**OEM No :**

002 981 4681

**Model:**

G100-12

**EX / CROSS :**

NP 057427

**T70139**



**Description:**

TAPERED ROLLER BEARING (45X95X29)

**Packaging Unit:** 1

**OEM No :**

016 981 5605

**Model:**

**EX / CROSS :**

**T37813**



**Description:**

TAPERED ROLLER BEARING (50,8X100X34,95)

**Packaging Unit:** 1

**OEM No :**

015 981 9005

**Model:**

G221-9/10,19-1,00  
G240-16/11,72-0,69  
G330-12/11,64-0,78  
GO210-6/6,53-0,80

**EX / CROSS :**

014 981 1405

013 981 0605

012 981 7405

012 981 7205

**T38690**



**Description:**

TAPERED ROLLER BEARING (50X41)

**Packaging Unit:** 1

**OEM No :**

015 981 7605

**Model:**

G210-16/14,2-0,83  
G211-12 Klauen  
G211-16/17,03-1,0  
G230-12 Klauen  
G230-16/14,2-0,83  
G231-16/17,03-1,0  
GO240-8/6,57-0,63  
GO250-8/6,57-0,63

**EX / CROSS :**

015 981 2005

014 981 3005

014 981 1505

014 981 0705

**T22624**



**Description:**

TAPERED ROLLER BEARING (50X90X32)

**Packaging Unit: 1**

**OEM No :**

002 981 7905

**Model:**

G155-16/11,9  
G155-16/14,0  
G180-16/11,9  
G180-16/14,0  
G200-16/11,9  
G210-16/14,2-0,83

**EX / CROSS :**

011 981 7605

SET 1110

**T58400**



**Description:**

TAPERED ROLLER BEARING (54,49X104,77X36,51)

**Packaging Unit: 1**

**OEM No :**

005 981 4605

**Model:**

AL 7/1 D-7  
AL 7/1 DS-7  
AL 7/5 D-7  
AL 7/8 D-8  
HL 7/1 D-10  
HL 7/1 DL-10  
HL 7/1 L-10  
HL 7/1 S-10  
HL 7/1-10  
HL 7/10 D-9  
HL 7/18 D-13  
HL 7/18 D-13 TURKEY  
HL 7/18 DS-13  
HL 7/18 DS-13 TURKEY  
HL 7/233  
HL 7/24 DS-9  
HL 7/26 D-11,5  
HL 7/26 D-12,3  
HL 7/26 DL-12,3  
HL 7/3 D-10  
HL 7/3 DL-10  
HL 7/3 DS-10  
HL 7/4 D-10  
HL 7/55 DCS-13

**EX / CROSS :**

003 981 9005

003 981 8905

003 981 8805

**T63534**



**Description:**

TAPERED ROLLER BEARING (55X117X38)

**Packaging Unit: 1**

**OEM No :**

016 981 4405

**Model:**

G211-12 Klauen

**EX / CROSS :**

016 981 7881

002 981 7981

**T61866**



**Description:**

TAPERED ROLLER BEARING (55X130X27,25)

**Packaging Unit: 1**

**OEM No :**

016 981 0105

**Model:**

G131-9  
G141-9

**EX / CROSS :**

016 981 0205

016 981 0305

016 981 1605

016 981 0005

**T58515**



**Description:**

TAPERED ROLLER BEARING (55X140X45)

**Packaging Unit: 1**





**OEM No :**

014 981 7905

**Model:**

HH 4/08 D-10,5  
HH 4/08 D-11  
HH 4/08 DL-11  
HL 4/063 D-11  
HL 4/063 DS-11

**EX / CROSS :**

<p><b>T37781</b></p> 	<p><b>Description:</b> TAPERED ROLLER BEARING (55X29,8)</p> <p><b>Packaging Unit:</b> 1</p> <p><b>OEM No :</b> 015 981 6205</p> <p><b>Model:</b> G240-16/11,72-0,69 G241-16 Klauen G260-16/9,75-0,57 G280-16 Klauen</p> <p><b>EX / CROSS :</b> 017 981 2205 011 981 1905 ETA-C1R-1104</p>
<p><b>T38268</b></p> 	<p><b>Description:</b> TAPERED ROLLER BEARING (55X29,8)</p> <p><b>Packaging Unit:</b> 1</p> <p><b>OEM No :</b> 017 981 7105</p> <p><b>Model:</b> G281-12 Klauen G330-12/11,64-0,78</p> <p><b>EX / CROSS :</b></p>
<p><b>T39606</b></p> 	<p><b>Description:</b> TAPERED ROLLER BEARING (55X90X23)</p> <p><b>Packaging Unit:</b> 1</p> <p><b>OEM No :</b> 017 981 5705</p> <p><b>Model:</b></p> <p><b>EX / CROSS :</b> 015 981 7705 VKHB 2060 SET 1041 014 981 3105</p>
<p><b>T45155</b></p> 	<p><b>Description:</b> TAPERED ROLLER BEARING (56X140X36)</p> <p><b>Packaging Unit:</b> 1</p> <p><b>OEM No :</b> 009 981 9805</p> <p><b>Model:</b></p> <p><b>EX / CROSS :</b> 009 981 9005 009 981 8905 009 981 8305 000720 030313</p>
<p><b>T38378</b></p> 	<p><b>Description:</b> TAPERED ROLLER BEARING (57,16X140X28)</p> <p><b>Packaging Unit:</b> 1</p> <p><b>OEM No :</b> 014 981 3905</p> <p><b>Model:</b> G100-12</p> <p><b>EX / CROSS :</b> 014 981 1005 014 981 0905 013 981 9905 013 981 8505</p>



**T60952**



**Description:**

TAPERED ROLLER BEARING (59,98X134,98X33,44)

**Packaging Unit:** 1

**OEM No :**  
002 981 1105

**Model:**

HD 4/021 GS-10 BRAZIL	HH 4/19 D-10
HD 4/21 DG-10	HL 4/1-7,6
HD 4/21 G-10	HL 4/12 D-10 BRAZIL
HD 4/21 G-10 BRAZIL	HL 4/14 - 8,8
HD 4/22 D-10	HL 4/16 L-7,7
HD 4/22 DG-10	HL 4/16-7,7
HD 4/22-10	HL 4/17 - 9,2
HD 4/22-10 BRAZIL	HL 4/17 D-9,2
HH 4/12 - 10	HL 4/17 L-9,2
HH 4/12 D-10	HL 4/17 S-9,2
HH 4/12 D-10 BRAZIL	HL 4/23 - 7,7
HH 4/12-10	HL 4/23 L-7,7

**EX / CROSS :**

**T81537**



**Description:**

TAPERED ROLLER BEARING (60X110X34)

**Packaging Unit:** 1

**OEM No :**  
019 981 6105

**Model:**

G211-12 Klauen  
G230-12 Klauen

**EX / CROSS :**

002 981 7781  
002 981 5280

**T22617**



**Description:**

TAPERED ROLLER BEARING (60X130X33,25)

**Packaging Unit:** 1

**OEM No :**  
014 981 6105

**Model:**

G155-16/11,9	G241-16 Klauen
G155-16/14,0	G260-16/9,75-0,57
G155-9/15,9	G280-16 Klauen
G180-16/11,9	G330-12/11,64-0,78
G180-16/14,0	GO210-8/11,8
G200-16/11,9	
G210-16/14,2-0,83	
G211-16/17,03-1,0	
G221-9/10,19-1,00	
G230-16/14,2-0,83	
G231-16/17,03-1,0	
G240-16/11,72-0,69	

**EX / CROSS :**

805046/801464

**T22649**



**Description:**

TAPERED ROLLER BEARING (60X130X33,5)

**Packaging Unit:** 1

**OEM No :**  
016 981 1205

**Model:**

G155-16/11,9	G240-16/11,72-0,69
G155-16/14,0	G241-16 Klauen
G155-9/15,9	G260-16/9,75-0,57
G180-16/11,9	G280-16 Klauen
G180-16/14,0	G281-12 Klauen
G181-9	GO210-8/11,8
G200-16/11,9	
G210-16/14,2-0,83	
G211-16/17,03-1,0	
G221-9/10,19-1,00	
G230-16/14,2-0,83	
G231-16/17,03-1,0	

**EX / CROSS :**

013 981 7305  
012 981 9405  
012 981 9205  
012 981 7505

**T85628**



**Description:**

TAPERED ROLLER BEARING (60X130X51)

**Packaging Unit:** 1

**OEM No :**  
018 981 6805

**Model:**

G281-12 Klauen  
G330-12/11,64-0,78

**EX / CROSS :**

**T58518**



**Description:**

TAPERED ROLLER BEARING (60X150X51)

**Packaging Unit:** 1

**OEM No :**

014 981 7805

**Model:**

HH 4/08 D-10,5  
HH 4/08 D-11  
HH 4/08 DL-11  
HL 4/063 D-11  
HL 4/063 DS-11

**EX / CROSS :**

**T61826**



**Description:**

TAPERED ROLLER BEARING (60X51)

**Packaging Unit:** 1

**OEM No :**

002 981 8181

**Model:**

G181-9  
G221-9/10,19-1,00  
G240-16/11,72-0,69  
G241-16 Klauen  
G260-16/9,75-0,57  
G280-16 Klauen  
G281-12 Klauen  
G330-12/11,64-0,78

**EX / CROSS :**

F-563007.RTR1

**T60975**



**Description:**

TAPERED ROLLER BEARING (65X110X34)

**Packaging Unit:** 1

**OEM No :**

008 981 8305

**Model:**

AL 7/1 D-7  
AL 7/1 DS-7  
AL 7/5 D-7  
AL 7/8 D-8  
HD 7/11 DG-9  
HD 7/19 DG-13  
HD 7/19 DG-13 TURKEY  
HD 7/19 DGS-13  
HD 7/19 DGS-13 TURKEY  
HD 7/19 DSG-13  
HD 7/2 DG-10  
HD 7/2 DLG-10

HD 7/2 DSG-10  
HD 7/5 DG-10  
HL 7/1 D-10  
HL 7/1 DL-10  
HL 7/1 L-10  
HL 7/1 S-10  
HL 7/1-10  
HL 7/10 D-9  
HL 7/18 D-13  
HL 7/18 D-13 TURKEY  
HL 7/18 DS-13  
HL 7/18 DS-13 TURKEY

**EX / CROSS :**

006 981 8805

005 981 4705

003 981 8205

003 981 4105

**T52395**



**Description:**

TAPERED ROLLER BEARING (65X140X33)

**Packaging Unit:** 1

**OEM No :**

012 981 3705

**Model:**

GO170-6/8,2-1,0  
GO190-6/8,2-1,0  
GO210-6/6,53-0,80  
GO230-6/6,5-0,8  
GO240-8/6,57-0,63  
GO4/160-6/8,2

**EX / CROSS :**

015 981 4005

**T38068**



**Description:**

TAPERED ROLLER BEARING (65X145X36)

**Packaging Unit:** 1

**OEM No :**

001 981 9905

**Model:**

HL 5/02 D-10 BRAZIL  
HL 5/02-10 BRAZIL  
HL 5/1 S-10  
HL 5/1 Z-10  
HL 5/2 DZ-10 BRAZIL  
HL 5/2 S-10  
HL 5/2 S-6,5  
HL 5/2 Z(S)-10 BRAZIL  
HL 5/2 Z-10  
HL 5/2 ZL-10  
HL 5/2 ZS-10  
HL 5/2-10

HL 5/60 DZ-10  
HO 5/4 Z-10  
HO 5/8 DL-10  
HO 5/8 DZ-10  
HO 5/8 L-10

**EX / CROSS :**

000 981 7705

000 981 6505

**T56481**



**Description:**

TAPERED ROLLER BEARING (65X145X39,5)

**Packaging Unit:** 1

**OEM No :**

003 981 1205

**Model:**

HL 5/02 D-10 BRAZIL  
HL 5/02-10 BRAZIL  
HL 5/1 S-10  
HL 5/1 Z-10  
HL 5/2 DZ-10 BRAZIL  
HL 5/2 S-10  
HL 5/2 S-6,5  
HL 5/2 Z(S)-10 BRAZIL  
HL 5/2 Z-10  
HL 5/2 ZL-10  
HL 5/2 ZS-10  
HL 5/2-10  
HL 5/60 DZ-10  
HO 5/4 Z-10  
HO 5/8 DL-10  
HO 5/8 DZ-10  
HO 5/8 L-10

**EX / CROSS :**

003 981 1905

386 981 7105

386 981 7405

**T63139**



**Description:**

TAPERED ROLLER BEARING (65X152X48)

**Packaging Unit:** 1

**OEM No :**

014 981 2105

**Model:**

HL 6/1 DC(L,S)-13  
(REINFORCED)  
HL 6/1 DC(LC)-13 (OLD  
VERSION)  
HL 6/1 DC(LC)-13  
(REINFORCED)  
HL 6/3 DC(L,S)-13 (OLD  
VERSION)  
HL 8/1 DCS-13  
HO 6/1 DCL(S)-13  
HO 6/2 DCL(S)-13  
HO 6/4 DCL(S)-13  
HO 6/5 DCL(S)-13

**EX / CROSS :**

014 981 2005

**T58371**



**Description:**

TAPERED ROLLER BEARING (65X165X36)

**Packaging Unit:** 1

**OEM No :**

011 981 0705

**Model:**

HD 4/02 DG-10  
HD 4/02 DG-10 BRAZIL  
HD 4/02 GD-10  
HD 4/03 D-10  
HD 4/03 D-10 BRAZIL  
HH 4/04 D-12  
HH 4/05 D-10 BRAZIL  
HH 4/07 DL-10 BRAZIL  
HL 4/01 - 10  
HL 4/01 D-10  
HL 4/01 D-10 BRAZIL  
HL 4/01 DL-10  
HL 4/01 DL-11,5  
HL 4/01 L-10  
HL 4/01-10  
HL 4/05 D-9,2  
HL 4/06 D-12  
HL 4/06 DL-12  
HL 4/07 D-9,4  
HL 4/08 D-10,6  
HL 4/09 D-9,2  
HO 4/01 D-10 BRAZIL  
HO 4/01 D-10 TURKEY  
HO 4/01 DL-10

**EX / CROSS :**

006 981 1905

006 981 1705

**T58375**



**Description:**

TAPERED ROLLER BEARING (65X165X40)

**Packaging Unit:** 1

**OEM No :**

006 981 3505

**Model:**

HD 4/02 DG-10  
HD 4/02 DG-10 BRAZIL  
HD 4/02 GD-10  
HD 4/03 D-10  
HD 4/03 D-10 BRAZIL  
HH 4/04 D-12  
HH 4/05 D-10 BRAZIL  
HH 4/07 DL-10 BRAZIL  
HL 4/01 - 10  
HL 4/01 D-10  
HL 4/01 D-10 BRAZIL  
HL 4/01 DL-10  
HL 4/01 L-10  
HL 4/01-10  
HL 4/035 D-10,6  
HL 4/035 D-9,2  
HL 4/038 D-10  
HL 4/038 D-12  
HL 4/038 D-9,4  
HL 4/039 D-10  
HL 4/039 D-12  
HL 4/039 DL-12  
HL 4/05 D-9,2  
HL 4/06 D-12

**EX / CROSS :**

009 981 6905

006 981 3405

**T38393**



**Description:**

TAPERED ROLLER BEARING (65X31)

**Packaging Unit:** 1

**OEM No :**

002 981 4581

**Model:**

G100-12

**EX / CROSS :**

**T65012**



**Description:**

TAPERED ROLLER BEARING (69,85X120,00X32,55)

**Packaging Unit:** 1

**OEM No :**

002 981 2605

**Model:**

**EX / CROSS :**

002 981 1605

**T75384**



**Description:**

TAPERED ROLLER BEARING (70X110X31)

**Packaging Unit:** 1

**OEM No :**

006 981 7605

**Model:**

AL 3/2-5  
AL 3/4-4,3  
AL 3/5-3,5  
AL 3/5-5,5  
AL 3/7 D-4,3  
AL 3/7-4,3  
AL 3/8 D-4,7  
HD 7/055 DCGS-13  
HD 7/056 DGS-13  
HD 7/056 DGS-16  
HD 7/55 DCGS-13  
HD 7/56 DGS-13

HL 7/233  
HL 7/55 DCS-13  
HL 7/56 DS-13

**EX / CROSS :**

005 981 6905

005 981 5505

**T60460**



**Description:**

TAPERED ROLLER BEARING (70X150X54)

**Packaging Unit:** 1

**OEM No :**

003 981 2905

**Model:**

HD 7/014 DG-16  
HD 7/014 DGS-16  
HD 7/016 DG-13  
HD 7/016 DSG-13  
HD 7/055 DCGS-13  
HD 7/056 DGS-13  
HD 7/056 DGS-16  
HD 7/09 DG-10  
HL 7/013 D-16  
HL 7/013 DS-16 TURKEY  
HL 7/015 D-13  
HL 7/015 D-13 TURKEY

HL 7/015 DL-13  
HL 7/015 DS-13  
HL 7/02 DL-10  
HL 7/021 D-10  
HL 7/021 DL-10  
HL 7/021 DS-10  
HL 7/024 D-12,3  
HL 7/024 DL-12,3  
HL 7/050 DCS-11,5  
HL 7/050 DCS-13  
HL 7/052 DS-13  
HL 7/055 DCS-13

**EX / CROSS :**

**T60469**



**Description:**

TAPERED ROLLER BEARING (75X125X37)

**Packaging Unit:** 1

**OEM No :**

003 981 3205

**Model:**

**EX / CROSS :**

000 981 4218

003 981 3005

008 981 0305

**T61957**



**Description:**

TAPERED ROLLER BEARING (75X130X33,25)

**Packaging Unit:** 1

**OEM No :**

942 981 0205

**Model:**

HD 7/055 DCGS-13  
HD 7/056 DGS-13  
HD 7/056 DGS-16

**EX / CROSS :**

327 981 0305

001 981 4805

000 981 8405

000 981 7405



<p><b>T22631</b></p> 	<p><b>Description:</b> TAPERED ROLLER BEARING (75X140X34,25)</p> <p><b>Packaging Unit:</b> 1</p> <p><b>OEM No :</b> 011 981 1305</p> <p><b>EX / CROSS :</b> 580616 TR1</p> <p><b>Model:</b> G155-16/11,9 G155-16/14,0 G155-9/15,9 G180-16/11,9 G180-16/14,0 G181-9 G200-16/11,9 G210-16/14,2-0,83 G211-12 Klauen G211-16/17,03-1,0 G221-9/10,19-1,00 G230-12 Klauen</p> <p>G230-16/14,2-0,83 G231-16/17,03-1,0 G240-16/11,72-0,69 G241-16 Klauen G260-16/9,75-0,57 G280-16 Klauen G281-12 Klauen G330-12/11,64-0,78 GO170-6/8,2-1,0 GO190-6/8,2-1,0 GO210-6/6,53-0,80 GO210-8/11,8</p>
<p><b>T55915</b></p> 	<p><b>Description:</b> TAPERED ROLLER BEARING (80X140X28,25)</p> <p><b>Packaging Unit:</b> 1</p> <p><b>OEM No :</b> 009 981 6205</p> <p><b>EX / CROSS :</b> 009 981 4705 009 981 1005 009 981 0605 001 981 8505</p> <p><b>Model:</b> G125-16/14,0 G135-16/11,9</p>
<p><b>T56241</b></p> 	<p><b>Description:</b> TAPERED ROLLER BEARING (80X165X57)</p> <p><b>Packaging Unit:</b> 1</p> <p><b>OEM No :</b> 014 981 2205</p> <p><b>EX / CROSS :</b> 012 981 8405</p> <p><b>Model:</b> HL 8/1 DCS-13 HO 8/1 DCL(S)-13</p>
<p><b>T81546</b></p> 	<p><b>Description:</b> TAPERED ROLLER BEARING (85X140X41)</p> <p><b>Packaging Unit:</b> 1</p> <p><b>OEM No :</b> 005 981 9905</p> <p><b>EX / CROSS :</b> 386 981 0005 005 981 8605 005 981 8305 001 980 6702</p> <p><b>Model:</b> HD 4/02 DG-10 HD 4/02 DG-10 BRAZIL HD 4/02 GD-10 HD 4/03 D-10 HD 4/03 D-10 BRAZIL HH 4/04 D-12 HH 4/05 D-10 BRAZIL HH 4/07 DL-10 BRAZIL HL 4/01 - 10 HL 4/01 D-10 HL 4/01 D-10 BRAZIL HL 4/01 DL-10</p> <p>HL 4/01 DL-11,5 HL 4/01 L-10 HL 4/01-10 HL 4/035 D-10,6 HL 4/038 D-10 HL 4/038 D-12 HL 4/038 D-9,4 HL 4/039 D-10 HL 4/039 D-12 HL 4/039 DL-12 HL 4/06 D-12 HL 4/06 DL-12</p>
<p><b>T73116</b></p> 	<p><b>Description:</b> TAPERED ROLLER BEARING (99,98X156,98X42)</p> <p><b>Packaging Unit:</b> 1</p> <p><b>OEM No :</b> 009 981 4305</p> <p><b>EX / CROSS :</b> 011 981 2305 011 981 3605</p> <p><b>Model:</b> HD 7/055 DCGS-13 HD 7/056 DGS-13 HD 7/55 DCGS-13 HD 7/56 DGS-13 HL 6/1 DC(L,S)-13 (REINFORCED) HL 6/1 DC(LC)-13 (OLD VERSION) HL 6/1 DC(LC)-13 (REINFORCED) HL 6/3 DC(L,S)-13 (OLD VERSION) HL 7/015 DL-13</p> <p>HL 7/56 DS-13 HL 8/1 DCS-13 HO 6/1 DCL(S)-13 HO 6/2 DCL(S)-13 HO 6/4 DCL(S)-13 HO 6/5 DCL(S)-13 HO 6/6 DCL(S)-13 HO 6/DCL-13 HO 8/1 DCL(S)-13</p>



**T37799**



**Description:**

TAPERED ROLLER BEARING CONE (50X41,2)

**Packaging Unit: 1**

**OEM No :**

017 981 5105

**Model:**

G210-16/14,2-0,83  
G240-16/11,72-0,69  
G241-16 Klauen  
G260-16/9,75-0,57  
G280-16 Klauen  
G281-12 Klauen  
G330-12/11,64-0,78

**EX / CROSS :**

017 981 2305  
015 981 9505  
015 981 6105  
014 981 2605

**T76135**



**Description:**

TEMPERATURE SENSOR FOR VOITH RETARDER

**Packaging Unit: 1**

**OEM No :**

001 540 5217

**Model:**

**EX / CROSS :**

000 821 0081

**T15277**



**Description:**

THREADED PIN (M6X12)

**Packaging Unit: 5**

**OEM No :**

357 990 0079

**Model:**

**EX / CROSS :**

385 990 0179

**T15169**



**Description:**

THREADED PIN (M6X14)

**Packaging Unit: 5**

**OEM No :**

000914 006109

**Model:**

G125-16/14,0  
G131-9  
G135-16/11,9  
G141-9  
G155-16/11,9  
G155-16/14,0  
G155-9/15,9  
G180-16/11,9  
G180-16/14,0  
G181-9  
G200-16/11,9  
G210-16/14,2-0,83  
G211-12 Klauen  
G211-16/17,03-1,0  
G221-9/10,19-1,00  
G230-12 Klauen  
G230-16/14,2-0,83  
G231-16/17,03-1,0  
G240-16/11,72-0,69  
G241-16 Klauen  
G260-16/9,75-0,57  
G280-16 Klauen  
G281-12 Klauen  
G330-12/11,64-0,78

**EX / CROSS :**

**T08970**



**Description:**

THRUST WASHER

**Packaging Unit: 4**

**OEM No :**





346 353 0124

**Model:**

HD 7/014 DG-16  
HD 7/014 DGS-16  
HD 7/014 DGS-16 TURKEY  
HD 7/016 DG-13  
HD 7/016 DSG-13  
HD 7/09 DG-10  
HL 7/013 D-16  
HL 7/013 DS-16 TURKEY  
HL 7/015 D-13  
HL 7/015 D-13 TURKEY  
HL 7/015 DL-13  
HL 7/015 DS-13  
HL 7/02 DL-10  
HL 7/021 D-10  
HL 7/021 DL-10  
HL 7/021 DS-10  
HL 7/024 D-12,3  
HL 7/024 DL-12,3  
HL 7/050 DCS-11,5  
HL 7/050 DCS-13  
HL 7/052 DS-13  
HL 7/07 D-10  
HL 7/07 D-11,5  
HL 7/07 DL-10

**EX / CROSS :**







<p><b>T15316</b></p> 	<p><b>Description:</b> THRUST WASHER</p> <p><b>OEM No :</b> 389 263 0062</p> <p><b>EX / CROSS :</b></p>	<p><b>Packaging Unit:</b> 1</p> <p><b>Model:</b> G125-16/14,0 G135-16/11,9 G155-16/11,9 G155-16/14,0 G155-9/15,9 G180-16/11,9 G180-16/14,0 G200-16/11,9 GO210-8/11,8</p>
<p><b>T11113</b></p> 	<p><b>Description:</b> THRUST WASHER</p> <p><b>OEM No :</b> 346 354 1362</p> <p><b>EX / CROSS :</b> 355 354 0462</p>	<p><b>Packaging Unit:</b> 10</p> <p><b>Model:</b> AL 7/1 D-7 AL 7/1 DS-7 AL 7/5 D-7 AL 7/8 D-8 HD 7/014 DG-16 HD 7/014 DGS-16 HD 7/014 DGS-16 TURKEY HD 7/016 DG-13 HD 7/016 DSG-13 HD 7/055 DCGS-13 HD 7/056 DGS-13 HD 7/056 DGS-16</p> <p>HD 7/09 DG-10 HD 7/11 DG-9 HD 7/19 DG-13 HD 7/19 DG-13 TURKEY HD 7/19 DGS-13 HD 7/19 DGS-13 TURKEY HD 7/2 DG-10 HD 7/2 DLG-10 HD 7/2 DSG-10 HD 7/5 DG-10 HD 7/55 DCGS-13</p>
<p><b>T08972</b></p> 	<p><b>Description:</b> THRUST WASHER</p> <p><b>OEM No :</b> 346 353 0224</p> <p><b>EX / CROSS :</b></p>	<p><b>Packaging Unit:</b> 4</p> <p><b>Model:</b> HD 7/014 DG-16 HD 7/014 DGS-16 HD 7/014 DGS-16 TURKEY HD 7/016 DG-13 HD 7/016 DSG-13 HD 7/09 DG-10</p>
<p><b>T11717</b></p> 	<p><b>Description:</b> THRUST WASHER</p> <p><b>OEM No :</b> 615 353 0162</p> <p><b>EX / CROSS :</b></p>	<p><b>Packaging Unit:</b> 4</p> <p><b>Model:</b> HD 4/02 DG-10 HD 4/02 GD-10 HH 4/07 DL-10 BRAZIL HL 4/01 D-10 BRAZIL HO 4/01 D-10 BRAZIL HO 4/01 DL-10 BRAZIL</p>
<p><b>T70990</b></p> 	<p><b>Description:</b> THRUST WASHER</p> <p><b>OEM No :</b> 948 353 0024</p> <p><b>EX / CROSS :</b></p>	<p><b>Packaging Unit:</b> 4</p> <p><b>Model:</b> HL 6/1 DC(L,S)-13 (REINFORCED) HL 6/1 DC(LC)-13 (OLD VERSION) HL 6/1 DC(LC)-13 (REINFORCED) HL 6/3 DC(L,S)-13 (OLD VERSION) HO 6/1 DCL(S)-13 HO 6/2 DCL(S)-13 HO 6/4 DCL(S)-13 HO 6/5 DCL(S)-13 HO 6/6 DCL(S)-13</p>







<p><b>T08984</b></p> 	<p><b>Description:</b> THRUST WASHER</p> <p><b>Packaging Unit:</b> 2</p> <p><b>OEM No :</b> 346 353 0562</p> <p><b>Model:</b></p> <p><b>EX / CROSS :</b></p>
<p><b>T09020</b></p> 	<p><b>Description:</b> THRUST WASHER</p> <p><b>Packaging Unit:</b> 2</p> <p><b>OEM No :</b> 355 353 0562</p> <p><b>Model:</b></p> <p><b>EX / CROSS :</b></p>
<p><b>T01159</b></p> 	<p><b>Description:</b> THRUST WASHER</p> <p><b>Packaging Unit:</b> 2</p> <p><b>OEM No :</b> 674 353 0362</p> <p><b>Model:</b></p> <p><b>EX / CROSS :</b> 322 353 0162</p>
<p><b>T19020</b></p> 	<p><b>Description:</b> THRUST WASHER</p> <p><b>Packaging Unit:</b> 4</p> <p><b>OEM No :</b> 346 353 0524</p> <p><b>Model:</b> HD 7/055 DCGS-13 HD 7/056 DGS-13 HD 7/056 DGS-16 HL 7/055 DCS-13</p> <p><b>EX / CROSS :</b></p>
<p><b>T19883</b></p> 	<p><b>Description:</b> THRUST WASHER</p> <p><b>Packaging Unit:</b> 1</p> <p><b>OEM No :</b> 346 356 1415</p> <p><b>Model:</b> HD 7/19 DG-13 HD 7/19 DGS-13</p> <p><b>EX / CROSS :</b> 346 356 0315</p>









<p><b>T09012</b></p> 	<p><b>Description:</b> THRUST WASHER</p> <p><b>OEM No :</b> 355 353 0176</p> <p><b>EX / CROSS :</b></p>	<p><b>Packaging Unit:</b> 4</p> <p><b>Model:</b> HD 4/02 DG-10 HD 4/02 DG-10 BRAZIL HD 4/02 GD-10 HD 4/021 GS-10 BRAZIL HD 4/21 DG-10 HD 4/21 G-10 HD 4/21 G-10 BRAZIL HD 4/22-10 HD 7/11 DG-9 HD 7/19 DG-13 HD 7/19 DG-13 TURKEY HD 7/19 DGS-13</p> <p>HD 7/19 DGS-13 TURKEY HD 7/19 DSG-13 HD 7/2 DG-10 HD 7/2 DLG-10 HD 7/2 DSG-10 HD 7/5 DG-10</p>
<p><b>T01147</b></p> 	<p><b>Description:</b> THRUST WASHER</p> <p><b>OEM No :</b> 352 353 0024</p> <p><b>EX / CROSS :</b> 312 353 1224</p>	<p><b>Packaging Unit:</b> 4</p> <p><b>Model:</b> AL 3/2-5 AL 3/4-4,3 AL 3/5-3,5 AL 3/5-5,5 AL 3/6 D-6 AL 3/6-6 AL 3/7 D-4,3 AL 3/7-4,3 AL 3/8 D-4,7 AL 3/8 DS-4,7 AL 3/9 D-6,8 HD 4/021 GS-10 BRAZIL</p> <p>HD 4/21 DG-10 HD 4/21 G-10 HD 4/21 G-10 BRAZIL HD 4/22 D-10 HD 4/22 DG-10 HD 4/22-10 HD 4/22-10 BRAZIL HH 4/12 - 10 HH 4/12 D-10 HH 4/12 D-10 BRAZIL HH 4/12-10 HH 4/19 D-10</p>
<p><b>T70980</b></p> 	<p><b>Description:</b> THRUST WASHER</p> <p><b>OEM No :</b> 948 353 0062</p> <p><b>EX / CROSS :</b></p>	<p><b>Packaging Unit:</b> 2</p> <p><b>Model:</b> HL 6/1 DC(L,S)-13 (REINFORCED) HL 6/1 DC(LC)-13 (OLD VERSION) HL 6/1 DC(LC)-13 (REINFORCED) HL 6/3 DC(L,S)-13 (OLD VERSION) HO 6/1 DCL(S)-13 HO 6/2 DCL(S)-13 HO 6/4 DCL(S)-13 HO 6/5 DCL(S)-13 HO 6/6 DCL(S)-13</p>
<p><b>T17846</b></p> 	<p><b>Description:</b> THRUST WASHER</p> <p><b>OEM No :</b> 304 353 0162</p> <p><b>EX / CROSS :</b></p>	<p><b>Packaging Unit:</b> 4</p> <p><b>Model:</b> AL 6/2 D-6 HD 6/3 D-10 HD 6/3 DG-10 HL 7/015 D-13 HL 7/07 D-10</p>
<p><b>T15372</b></p> 	<p><b>Description:</b> THRUST WASHER</p> <p><b>OEM No :</b> 346 336 0062</p> <p><b>EX / CROSS :</b></p>	<p><b>Packaging Unit:</b> 1</p> <p><b>Model:</b> AL 7/1 D-7 AL 7/1 DS-7 AL 7/5 D-7 AL 7/8 D-8 HD 7/014 DG-16 HD 7/014 DGS-16 TURKEY HD 7/016 DG-13 HD 7/016 DSG-13 HD 7/056 DGS-13 HD 7/056 DGS-16 HD 7/09 DG-10 HD 7/11 DG-9</p> <p>HD 7/19 DG-13 HD 7/19 DG-13 TURKEY HD 7/19 DGS-13 TURKEY HD 7/19 DSG-13 HD 7/2 DG-10 HD 7/2 DLG-10 HD 7/2 DSG-10 HD 7/5 DG-10 HL 7/013 D-16 HL 7/013 DS-16 TURKEY HL 7/015 D-13 HL 7/015 D-13 TURKEY</p>



<p><b>T75752</b></p> 	<p><b>Description:</b> THRUST WASHER</p>	<p><b>Packaging Unit:</b> 4</p>
	<p><b>OEM No :</b> 694 353 0062</p>	<p><b>Model:</b> HL 5/60 DZ-10</p>
	<p><b>EX / CROSS :</b></p>	
<p><b>T18703</b></p> 	<p><b>Description:</b> THRUST WASHER</p>	<p><b>Packaging Unit:</b> 2</p>
	<p><b>OEM No :</b> 002 353 9177</p>	<p><b>Model:</b> HD 7/055 DCGS-13 HD 7/056 DGS-13 HD 7/056 DGS-16 HD 7/55 DCGS-13 HD 7/56 DGS-13</p>
	<p><b>EX / CROSS :</b></p>	
<p><b>T12324</b></p> 	<p><b>Description:</b> THRUST WASHER</p>	<p><b>Packaging Unit:</b> 4</p>
	<p><b>OEM No :</b> 395 353 0277</p>	<p><b>Model:</b> AL 7/1 D-7 AL 7/1 DS-7 AL 7/5 D-7 HD 7/11 DG-9 HD 7/19 DG-13 HD 7/19 DG-13 TURKEY HD 7/19 DGS-13 HD 7/19 DGS-13 TURKEY HD 7/19 DSG-13 HD 7/2 DG-10 HD 7/2 DLG-10 HD 7/2 DSG-10 HD 7/5 DG-10 HD 7/55 DCGS-13 HD 7/56 DGS-13 HL 7/1 D-10 HL 7/1 DL-10 HL 7/1 L-10 HL 7/1 S-10 HL 7/1-10 HL 7/10 D-9 HL 7/18 D-13 HL 7/18 D-13 TURKEY HL 7/18 DS-13</p>
	<p><b>EX / CROSS :</b></p>	
<p><b>T14460</b></p> 	<p><b>Description:</b> THRUST WASHER</p>	<p><b>Packaging Unit:</b> 4</p>
	<p><b>OEM No :</b> 385 353 1262</p>	<p><b>Model:</b> HD 4/02 DG-10 HD 4/02 GD-10 HD 4/03 D-10 HD 4/03 D-10 BRAZIL HH 4/04 D-12 HL 4/01 - 10 HL 4/01 D-10 HL 4/01 D-10 BRAZIL HL 4/01 DL-10 HL 4/01 L-10 HL 4/05 D-9,2 HL 4/06 D-12 HL 4/06 DL-12 HL 4/07 D-9,4 HL 4/08 D-10,6 HL 4/09 D-9,2 HL 5/02 D-10 BRAZIL HL 5/02-10 BRAZIL HL 5/1 S-10 HL 5/1 Z-10 HL 5/2 DZ-10 BRAZIL HL 5/2 S-10 HL 5/2 S-6,5 HL 5/2 Z(S)-10 BRAZIL</p>
	<p><b>EX / CROSS :</b></p>	
<p><b>T08025</b></p> 	<p><b>Description:</b> THRUST WASHER</p>	<p><b>Packaging Unit:</b> 4</p>
	<p><b>OEM No :</b> 327 353 4762</p>	<p><b>Model:</b></p>
	<p><b>EX / CROSS :</b> 327 353 4662 327 353 0162</p>	



<p><b>T17847</b></p> 	<p><b>Description:</b> THRUST WASHER</p> <p><b>OEM No :</b> 304 353 0362</p> <p><b>EX / CROSS :</b></p>	<p><b>Packaging Unit:</b> 2</p> <p><b>Model:</b> AL 6/2 D-6 HD 6/3 D-10 HD 6/3 DG-10 HL 7/015 D-13 HL 7/07 D-10</p>
<p><b>T09035</b></p> 	<p><b>Description:</b> THRUST WASHER</p> <p><b>OEM No :</b> 494 335 0075</p> <p><b>EX / CROSS :</b></p>	<p><b>Packaging Unit:</b> 4</p> <p><b>Model:</b> AL 7/1 D-7 AL 7/5 D-7 HD 7/11 DG-9 HD 7/19 DG-13 HD 7/19 DGS-13 HD 7/19 DSG-13 HD 7/2 DG-10 HD 7/2 DLG-10 HD 7/2 DSG-10 HD 7/5 DG-10 HL 7/1 D-10 HL 7/1 DL-10 HL 7/1 L-10 HL 7/1 S-10 HL 7/1-10 HL 7/10 D-9 HL 7/18 D-13 HL 7/18 DS-13 HL 7/24 DS-9 HL 7/3 D-10 HL 7/3 DL-10 HL 7/3 DS-10 HL 7/4 D-10 HO 7/10 DL-11,5</p>
<p><b>T63127</b></p> 	<p><b>Description:</b> THRUST WASHER</p> <p><b>OEM No :</b> 942 353 0062</p> <p><b>EX / CROSS :</b></p>	<p><b>Packaging Unit:</b> 1</p> <p><b>Model:</b> HD 7/055 DCGS-13 HD 7/056 DGS-13 HD 7/056 DGS-16 HD 7/55 DCGS-13 HD 7/56 DGS-13</p>
<p><b>T18717</b></p> 	<p><b>Description:</b> THRUST WASHER</p> <p><b>OEM No :</b> (942 350 2223/W)</p> <p><b>EX / CROSS :</b></p>	<p><b>Packaging Unit:</b> 1</p> <p><b>Model:</b></p>
<p><b>T91057</b></p> 	<p><b>Description:</b> THRUST WASHER (STEEL)</p> <p><b>OEM No :</b> 346 353 2262</p> <p><b>EX / CROSS :</b></p>	<p><b>Packaging Unit:</b> 2</p> <p><b>Model:</b> HD 7/014 DG-16 HD 7/014 DGS-16 HD 7/014 DGS-16 TURKEY HD 7/016 DG-13 HD 7/016 DSG-13 HD 7/055 DCGS-13 HD 7/056 DGS-13 HD 7/056 DGS-16 HD 7/09 DG-10 HL 7/013 D-16 HL 7/013 DS-16 TURKEY HL 7/015 D-13 HL 7/015 D-13 TURKEY HL 7/015 DL-13 HL 7/015 DS-13 HL 7/02 DL-10 HL 7/021 D-10 HL 7/021 DL-10 HL 7/021 DS-10 HL 7/024 D-12,3 HL 7/024 DL-12,3 HL 7/050 DCS-11,5 HL 7/050 DCS-13 HL 7/052 DS-13</p>



<p><b>T11711</b></p> 	<p><b>Description:</b> THRUST WASHER (T.1,50)</p> <p><b>OEM No :</b> 615 353 0462</p> <p><b>EX / CROSS :</b> 385 353 4062 385 353 3062 385 353 2362</p>	<p><b>Packaging Unit:</b> 2</p> <p><b>Model:</b></p>
<p><b>T08023</b></p> 	<p><b>Description:</b> THRUST WASHER (T.1,50)</p> <p><b>OEM No :</b> 327 353 4962</p> <p><b>EX / CROSS :</b> 327 353 3962 327 353 3262 327 353 0062</p>	<p><b>Packaging Unit:</b> 2</p> <p><b>Model:</b> HL 5/02 D-10 BRAZIL HL 5/02-10 BRAZIL HL 5/1 S-10 HL 5/1 Z-10 HL 5/2 DZ-10 BRAZIL HL 5/2 S-6,5 HL 5/2 Z(S)-10 BRAZIL HL 5/2 Z-10 HL 5/2 ZL-10 HL 5/2 ZS-10 HL 5/2-10 HL 5/60 DZ-10 HO 5/4 Z-10 HO 5/8 DL-10 HO 5/8 DZ-10 HO 5/8 L-10</p>
<p><b>T14980</b></p> 	<p><b>Description:</b> THRUST WASHER (T.2,35)</p> <p><b>OEM No :</b> 346 353 2462</p> <p><b>EX / CROSS :</b> 346 353 0762</p>	<p><b>Packaging Unit:</b> 1</p> <p><b>Model:</b> HD 7/014 DG-16 HD 7/014 DGS-16 HD 7/014 DGS-16 TURKEY HD 7/016 DG-13 HD 7/016 DSG-13 HD 7/09 DG-10</p>
<p><b>T09507</b></p> 	<p><b>Description:</b> THRUST WASHER (T.2,35)</p> <p><b>OEM No :</b> 355 353 2262</p> <p><b>EX / CROSS :</b> 355 353 1062 355 353 0362</p>	<p><b>Packaging Unit:</b> 1</p> <p><b>Model:</b></p>
<p><b>T09509</b></p> 	<p><b>Description:</b> THRUST WASHER (T.2,60)</p> <p><b>OEM No :</b> 355 353 2362</p> <p><b>EX / CROSS :</b> 355 353 1162</p>	<p><b>Packaging Unit:</b> 1</p> <p><b>Model:</b> HD 4/02 DG-10 HD 4/02 DG-10 BRAZIL HD 4/02 GD-10 HD 4/021 GS-10 BRAZIL HD 4/21 DG-10 HD 4/21 G-10 HD 4/21 G-10 BRAZIL HD 4/22-10 HD 7/11 DG-9 HD 7/19 DG-13 HD 7/19 DG-13 TURKEY HD 7/19 DGS-13 HD 7/19 DGS-13 TURKEY HD 7/19 DSG-13 HD 7/2 DG-10 HD 7/2 DLG-10 HD 7/2 DSG-10 HD 7/5 DG-10 HD 7/19 DGS-13 TURKEY</p>





<p><b>T08989</b></p>	<p><b>Description:</b> THRUST WASHER (T.2,60)</p> <p><b>OEM No :</b> 346 353 2562</p> <p><b>EX / CROSS :</b> 346 353 0862</p>	<p><b>Packaging Unit:</b> 1</p> <p><b>Model:</b> HD 7/014 DG-16 HD 7/014 DGS-16 HD 7/016 DG-13 HD 7/016 DSG-13 HD 7/09 DG-10</p>
<p><b>T83195</b></p>	<p><b>Description:</b> THRUST WASHER (T.2,80)</p> <p><b>OEM No :</b> 355 353 2662</p> <p><b>EX / CROSS :</b></p>	<p><b>Packaging Unit:</b> 1</p> <p><b>Model:</b> HD 7/11 DG-9 HD 7/19 DG-13 HD 7/19 DGS-13 HD 7/19 DSG-13 HD 7/2 DG-10 HD 7/2 DLG-10 HD 7/2 DSG-10 HD 7/5 DG-10</p>
<p><b>T61084</b></p>	<p><b>Description:</b> THRUST WASHER (T.3,65)</p> <p><b>OEM No :</b> 355 353 2062</p> <p><b>EX / CROSS :</b> 355 353 0862</p>	<p><b>Packaging Unit:</b> 1</p> <p><b>Model:</b> HD 4/02 DG-10 HD 4/02 DG-10 BRAZIL HD 4/02 GD-10 HD 4/021 GS-10 BRAZIL HD 4/21 DG-10 HD 4/21 G-10 HD 4/21 G-10 BRAZIL HD 4/22-10 HD 7/11 DG-9 HD 7/19 DG-13 HD 7/19 DG-13 TURKEY HD 7/19 DGS-13 HD 7/19 DSG-13 HD 7/2 DG-10 HD 7/2 DLG-10 HD 7/2 DSG-10 HD 7/5 DG-10</p>
<p><b>T09160</b></p>	<p><b>Description:</b> THRUST WASHER (T.4,00)</p> <p><b>OEM No :</b> 355 353 1862</p> <p><b>EX / CROSS :</b> 355 353 0462</p>	<p><b>Packaging Unit:</b> 1</p> <p><b>Model:</b> HD 4/02 DG-10 HD 4/02 DG-10 BRAZIL HD 4/02 GD-10 HD 4/021 GS-10 BRAZIL HD 4/21 DG-10 HD 4/21 G-10 HD 4/21 G-10 BRAZIL HD 4/22-10 HD 7/11 DG-9 HD 7/19 DG-13 HD 7/19 DG-13 TURKEY HD 7/19 DGS-13 HD 7/19 DSG-13 HD 7/2 DG-10 HD 7/2 DLG-10 HD 7/2 DSG-10 HD 7/5 DG-10</p>
<p><b>T08976</b></p>	<p><b>Description:</b> THRUST WASHER (T.4,00)</p> <p><b>OEM No :</b> 346 353 1762</p> <p><b>EX / CROSS :</b> 346 353 0362</p>	<p><b>Packaging Unit:</b> 1</p> <p><b>Model:</b></p>



<p><b>T78237</b></p> 	<p><b>Description:</b> THRUST WASHER KIT</p> <p><b>OEM No :</b> TAS78237</p> <p><b>EX / CROSS :</b></p>	<p><b>Packaging Unit:</b> 1</p> <p><b>Model:</b></p>
<p><b>T70074</b></p> 	<p><b>Description:</b> TRANSDUCER</p> <p><b>OEM No :</b> 012 542 5617</p> <p><b>EX / CROSS :</b> 012 542 7117</p>	<p><b>Packaging Unit:</b> 1</p> <p><b>Model:</b> G210-16/14,2-0,83 G211-12 Klauen G211-16/17,03-1,0 G231-16/17,03-1,0 G240-16/11,72-0,69 G241-16 Klauen G280-16 Klauen G281-12 Klauen G330-12/11,64-0,78</p>
<p><b>T73952</b></p> 	<p><b>Description:</b> TRANSDUCER</p> <p><b>OEM No :</b> 004 542 5018</p> <p><b>EX / CROSS :</b></p>	<p><b>Packaging Unit:</b> 1</p> <p><b>Model:</b> G211-12 Klauen</p>
<p><b>T74891</b></p> 	<p><b>Description:</b> U-JOINT</p> <p><b>OEM No :</b> 654 411 0511</p> <p><b>EX / CROSS :</b> 389 411 0411</p>	<p><b>Packaging Unit:</b> 1</p> <p><b>Model:</b></p>
<p><b>T45491</b></p> 	<p><b>Description:</b> VALVE</p> <p><b>OEM No :</b> 001 260 8457</p> <p><b>EX / CROSS :</b> 001 260 4757 001 260 3557 000 260 5457</p>	<p><b>Packaging Unit:</b> 1</p> <p><b>Model:</b> MPS KIT</p>



T65037



**Description:**  
VALVE

**Packaging Unit:** 1

**OEM No :**  
930 430 0087

**Model:**  
VR 115 HV

**EX / CROSS :**

T55946

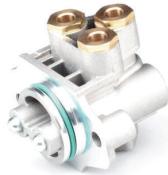

**Description:**  
VALVE

**Packaging Unit:** 1

**OEM No :**  
002 260 6257

**Model:**  
G210-16/14,2-0,83  
G221-9/10,19-1,00  
G231-16/17,03-1,0  
G240-16/11,72-0,69  
G260-16/9,75-0,57

**EX / CROSS :**

T84486



**Description:**  
VALVE

**Packaging Unit:** 1

**OEM No :**  
002 260 6157

**Model:**  
G210-16/14,2-0,83  
G211-16/17,03-1,0  
G240-16/11,72-0,69

**EX / CROSS :**

T68093



**Description:**  
VALVE

**Packaging Unit:**

**OEM No :**  
945 260 1957

**Model:**  
G131-9

**EX / CROSS :**  
405 264 0389

T84061



**Description:**  
VALVE REPAIR KIT





**Packaging Unit:** 1

**OEM No :**  
002 540 3997

**Model:**  
G181-9  
G230-16/14,2-0,83

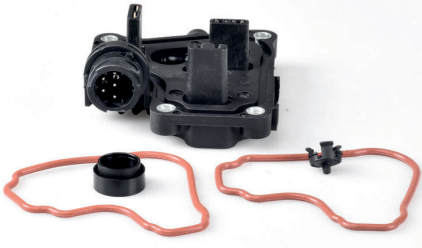



**EX / CROSS :**



<p><b>T84060</b></p> 	<p><b>Description:</b> VALVE REPAIR KIT</p> <p><b>OEM No :</b> 004 540 7481</p> <p><b>EX / CROSS :</b></p>	<p><b>Packaging Unit:</b> 1</p> <p><b>Model:</b> G211-12 Klauen G281-12 Klauen</p>
<p><b>T15159</b></p> 	<p><b>Description:</b> WASHER</p> <p><b>OEM No :</b> 389 262 1162</p> <p><b>EX / CROSS :</b> 945 262 0162 389 262 1462 389 262 1362</p>	<p><b>Packaging Unit:</b> 10</p> <p><b>Model:</b> G221-9/10,19-1,00 G240-16/11,72-0,69 G330-12/11,64-0,78</p>
<p><b>T15158</b></p> 	<p><b>Description:</b> WASHER</p> <p><b>OEM No :</b> 389 262 0262</p> <p><b>EX / CROSS :</b></p>	<p><b>Packaging Unit:</b> 10</p> <p><b>Model:</b> G125-16/14,0 G135-16/11,9 G155-16/11,9 G155-16/14,0 G155-9/15,9 G180-16/11,9 G180-16/14,0 G200-16/11,9 GO210-8/11,8</p>
<p><b>T75830</b></p> 	<p><b>Description:</b> WASHER</p> <p><b>OEM No :</b> 912006 010001</p> <p><b>EX / CROSS :</b></p>	<p><b>Packaging Unit:</b> 1</p> <p><b>Model:</b> HL 5/2 DZ-10 BRAZIL HL 5/2 Z(S)-10 BRAZIL HL 5/60 DZ-10</p>
<p><b>T15535</b></p> 	<p><b>Description:</b> WASHER</p> <p><b>OEM No :</b> 389 262 0062</p> <p><b>EX / CROSS :</b></p>	<p><b>Packaging Unit:</b> 1</p> <p><b>Model:</b> G155-16/11,9 G155-16/14,0 G180-16/11,9 G180-16/14,0 G200-16/11,9 GO4/160-6/8,2</p>





<p><b>T49308</b></p> 	<p><b>Description:</b> WASHER</p> <p><b>OEM No :</b> 007603 024105</p> <p><b>EX / CROSS :</b></p>	<p><b>Packaging Unit:</b> 10</p> <p><b>Model:</b> G100-12 G125-16/14,0 G135-16/11,9 G141-9 G155-16/11,9 G155-16/14,0 G155-9/15,9 G180-16/11,9 G180-16/14,0 G181-9 G200-16/11,9 G210-16/14,2-0,83 G211-12 Klauen G221-9/10,19-1,00 G230-16/14,2-0,83 G231-16/17,03-1,0 G240-16/11,72-0,69 G241-16 Klauen G260-16/9,75-0,57 G280-16 Klauen G330-12/11,64-0,78 G56-6 G60-6/9,20-1,00 G70-6</p>
<p><b>T12327</b></p> 	<p><b>Description:</b> WASHER</p> <p><b>OEM No :</b> 395 353 0451</p> <p><b>EX / CROSS :</b></p>	<p><b>Packaging Unit:</b> 4</p> <p><b>Model:</b></p>
<p><b>T15273</b></p> 	<p><b>Description:</b> WASHER</p> <p><b>OEM No :</b> 385 262 1152</p> <p><b>EX / CROSS :</b> 004 262 0062</p>	<p><b>Packaging Unit:</b> 10</p> <p><b>Model:</b> G3/65-8/9,29 G3/65-9/13,36 G3/90-8/9,29 UG3/40-8/13,01 UNIMOG UG3/65-8/13,01 UNIMOG</p>
<p><b>T45231</b></p> 	<p><b>Description:</b> WASHER</p> <p><b>OEM No :</b> 976 262 0462</p> <p><b>EX / CROSS :</b> 695 262 0062</p>	<p><b>Packaging Unit:</b> 1</p> <p><b>Model:</b> G85-6/6,70-0,83 GO110-6/6,1-0,747</p>
<p><b>T19644</b></p> 	<p><b>Description:</b> WASHER</p> <p><b>OEM No :</b> 912004 010102</p> <p><b>EX / CROSS :</b></p>	<p><b>Packaging Unit:</b> 1</p> <p><b>Model:</b> GV4/65-6/9,0 HD 6/3 D-10 HD 6/3 DG-10 HL 5/1 S-10 HL 5/1 Z-10 HL 5/2 S-10 HL 5/2 S-6,5 HL 5/2 Z-10 HL 5/2 ZL-10 HL 5/2 ZS-10 HL 5/2-10</p>



<p><b>T49296</b></p> 	<p><b>Description:</b> WASHER</p> <p><b>OEM No :</b> 976 262 0062</p> <p><b>EX / CROSS :</b></p>	<p><b>Packaging Unit:</b> 1</p> <p><b>Model:</b></p>
<p><b>T49324</b></p> 	<p><b>Description:</b> WASHER</p> <p><b>OEM No :</b> 970 262 0362</p> <p><b>EX / CROSS :</b> 383 282 0262</p>	<p><b>Packaging Unit:</b> 1</p> <p><b>Model:</b> G3/45-6/8,5 G3/50-5/8,5 G3/55-6/8,5 G3/60-5/5,4 G3/60-5/7,5 G4/65-6/9,0 G4/65-7/11,0 G56-6 G70-6 G71-6 G90-6 GO110-6/6,1-0,747</p> <p>G03/60-5/5,4 GV4/65-6/9,0 UG100-8/9,57-0,7 GPA UNIMOG</p>
<p><b>T94207</b></p> 	<p><b>Description:</b> WASHER</p> <p><b>OEM No :</b> 912009 035100</p> <p><b>EX / CROSS :</b></p>	<p><b>Packaging Unit:</b> 1</p> <p><b>Model:</b></p>
<p><b>T50090</b></p> 	<p><b>Description:</b> WASHER (20X93)</p> <p><b>OEM No :</b> 945 262 0762</p> <p><b>EX / CROSS :</b></p>	<p><b>Packaging Unit:</b> 1</p> <p><b>Model:</b> G181-9 G210-16/14,2-0,83 G211-12 Klauen G211-16/17,03-1,0 G221-9/10,19-1,00 G230-12 Klauen G230-16/14,2-0,83 G231-16/17,03-1,0 G240-16/11,72-0,69 G241-16 Klauen G260-16/9,75-0,57 G280-16 Klauen</p> <p>G281-12 Klauen G330-12/11,64-0,78</p>
<p><b>T39369</b></p> 	<p><b>Description:</b> WASHER (24X93)</p> <p><b>OEM No :</b> 389 262 0362</p> <p><b>EX / CROSS :</b> 945 262 0062</p>	<p><b>Packaging Unit:</b> 1</p> <p><b>Model:</b> G125-16/14,0 G135-16/11,9 G155-16/11,9 G155-16/14,0 G155-9/15,9 G180-16/11,9 G180-16/14,0 G181-9 G200-16/11,9 G210-16/14,2-0,83 G211-16/17,03-1,0 G221-9/10,19-1,00</p> <p>G230-16/14,2-0,83 G231-16/17,03-1,0 G240-16/11,72-0,69 G241-16 Klauen G260-16/9,75-0,57 G280-16 Klauen GO210-8/11,8</p>



<p><b>T50019</b></p> 	<p><b>Description:</b> WASHER (T.0,10)</p> <p><b>OEM No :</b> 389 262 3552</p> <p><b>EX / CROSS :</b></p>	<p><b>Packaging Unit:</b> 1</p> <p><b>Model:</b> G125-16/14,0 G135-16/11,9 G155-16/11,9 G155-16/14,0 G155-9/15,9 G180-16/11,9 G180-16/14,0 G200-16/11,9 G210-16/14,2-0,83 G240-16/11,72-0,69 GO210-8/11,8</p>
<p><b>T49292</b></p> 	<p><b>Description:</b> WASHER (T.3,90)</p> <p><b>OEM No :</b> 970 262 1152</p> <p><b>EX / CROSS :</b></p>	<p><b>Packaging Unit:</b> 1</p> <p><b>Model:</b> G60-6/9,20-1,00 G85-6/6,70-0,83 GO110-6/6,1-0,747</p>
<p><b>T49291</b></p> 	<p><b>Description:</b> WASHER (T.4,00)</p> <p><b>OEM No :</b> 970 262 1252</p> <p><b>EX / CROSS :</b></p>	<p><b>Packaging Unit:</b> 1</p> <p><b>Model:</b> G60-6/9,20-1,00 G85-6/6,70-0,83 GO110-6/6,1-0,747</p>
<p><b>T49290</b></p> 	<p><b>Description:</b> WASHER (T.4,10)</p> <p><b>OEM No :</b> 970 262 1352</p> <p><b>EX / CROSS :</b></p>	<p><b>Packaging Unit:</b> 1</p> <p><b>Model:</b> G60-6/9,20-1,00 G85-6/6,70-0,83 GO110-6/6,1-0,747</p>
<p><b>T49289</b></p> 	<p><b>Description:</b> WASHER (T.4,20)</p> <p><b>OEM No :</b> 970 262 1452</p> <p><b>EX / CROSS :</b></p>	<p><b>Packaging Unit:</b> 1</p> <p><b>Model:</b> G60-6/9,20-1,00 G85-6/6,70-0,83 GO110-6/6,1-0,747</p>



<p><b>T49288</b></p> 	<p><b>Description:</b> WASHER (T.4,30)</p> <p><b>OEM No :</b> 970 262 1552</p> <p><b>EX / CROSS :</b></p> <p><b>Model:</b> G60-6/9,20-1,00 G85-6/6,70-0,83 GO110-6/6,1-0,747</p> <p><b>Packaging Unit:</b> 1</p>
<p><b>T49287</b></p> 	<p><b>Description:</b> WASHER (T.4,40)</p> <p><b>OEM No :</b> 970 262 1652</p> <p><b>EX / CROSS :</b></p> <p><b>Model:</b> G60-6/9,20-1,00 G85-6/6,70-0,83 GO110-6/6,1-0,747</p> <p><b>Packaging Unit:</b> 1</p>
<p><b>T49286</b></p> 	<p><b>Description:</b> WASHER (T.4,50)</p> <p><b>OEM No :</b> 970 262 1752</p> <p><b>EX / CROSS :</b></p> <p><b>Model:</b> G60-6/9,20-1,00 G85-6/6,70-0,83 GO110-6/6,1-0,747</p> <p><b>Packaging Unit:</b> 1</p>
<p><b>T49285</b></p> 	<p><b>Description:</b> WASHER (T.4,60)</p> <p><b>OEM No :</b> 970 262 1852</p> <p><b>EX / CROSS :</b></p> <p><b>Model:</b> G60-6/9,20-1,00 G85-6/6,70-0,83 GO110-6/6,1-0,747</p> <p><b>Packaging Unit:</b> 1</p>
<p><b>T49284</b></p> 	<p><b>Description:</b> WASHER (T.4,70)</p> <p><b>OEM No :</b> 970 262 1952</p> <p><b>EX / CROSS :</b></p> <p><b>Model:</b> G60-6/9,20-1,00 G85-6/6,70-0,83 GO110-6/6,1-0,747</p> <p><b>Packaging Unit:</b> 1</p>





<p><b>T49283</b></p> 	<p><b>Description:</b> WASHER (T.4,80)</p> <p><b>OEM No :</b> 970 262 2052</p> <p><b>EX / CROSS :</b></p>	<p><b>Packaging Unit:</b> 1</p> <p><b>Model:</b> G60-6/9,20-1,00 G85-6/6,70-0,83 GO110-6/6,1-0,747</p>
<p><b>T69163</b></p> 	<p><b>Description:</b> WASHER (T.4,90)</p> <p><b>OEM No :</b> 970 262 2152</p> <p><b>EX / CROSS :</b></p>	<p><b>Packaging Unit:</b> 1</p> <p><b>Model:</b> G60-6/9,20-1,00 G85-6/6,70-0,83 GO110-6/6,1-0,747</p>
<p><b>T69162</b></p> 	<p><b>Description:</b> WASHER (T.5,00)</p> <p><b>OEM No :</b> 970 262 2252</p> <p><b>EX / CROSS :</b></p>	<p><b>Packaging Unit:</b> 1</p> <p><b>Model:</b> G60-6/9,20-1,00 G85-6/6,70-0,83 GO110-6/6,1-0,747</p>
<p><b>T84363</b></p> 	<p><b>Description:</b> WHEEL SENSOR</p> <p><b>OEM No :</b> 942 356 0715</p> <p><b>EX / CROSS :</b> 942 356 0315</p>	<p><b>Packaging Unit:</b> 1</p> <p><b>Model:</b> GO240-8/6,57-0,63 HL 6/1 DC(L,S)-13 (REINFORCED) HL 6/1 DC(LC)-13 (OLD VERSION) HL 6/1 DC(LC)-13 (REINFORCED) HL 6/3 DC(L,S)-13 (OLD VERSION) HL 7/050 DCS-11,5 HL 7/050 DCS-13 HL 7/055 DCS-13 HL 8/1 DCS-13</p> <p>HO 6/5 DCL(S)-13 HO 6/6 DCL(S)-13 HO 6/DCL-13 HO 8/1 DCL(S)-13</p>



OEM no.	TAS no. Pag.	OEM no.	TAS no. Pag.	OEM no.	TAS no. Pag.
000 077 0325	T08822 176	000 981 7987	T09033 149	001 981 5005	T65714 35
000 077 0425	T08822 176	000 981 8387	T15266 151	001 981 5087	T19647 149
000 254 0017	T73069 190	000 981 8405	T61957 265	001 981 7205	T56291 255
(000 260 0397/G)	T08826 174	000 981 8487	T15266 151	001 981 8505	T55915 266
(000 260 1197/G)	T08832 174	000 981 9701	T70993 58	001 981 9905	T38068 263
(000 260 1497/G)	T16711 174	000 990 6704	T19171 192	001 990 0103	T60941 191
000 260 3298	T74722 215	000 990 8904	T19207 192	001 990 2759	T41468 193
000 260 5457	T45491 275	000 994 9841	T57220 194	001 990 5000	T45742 192
000 262 8662	T22829 159	000 996 6645	T68315 34	001 991 7860	T39706 110
000 262 8762	T22833 159	000 996 6745	T68311 34	001 997 6848	T64126 152
000 262 9062	T22829 159	000 996 9345	T68315 34	001481 006011	T39706 110
000 262 9162	T22833 159	000 996 9445	T68311 34	002 260 6157	T84486 276
000 264 1960	T63263 194	000 996 9645	T68320 34	002 260 6257	T55946 276
000 264 5351	T61930 195	000000 005536	T49325 193	002 260 9563	T67825 57
000 267 0197	T22837 157	000000 005728	T50091 193	002 295 0706	T73716 40
000 267 0397	T22837 157	000000 006750	T50091 193	002 353 9177	T18703 271
000 350 0054	T51400 93	000471 120000	T50081 197	002 460 0880	T93584 125
000 350 0413	T64873 179	000472 060000	T50075 195	002 460 3980	T93584 125
000 350 1145	T19725 118	000472 100000	T60798 196	002 540 3997	T84061 276
000 350 4403	T51368 179	000472 130000	T50078 197	002 980 4802	T37921 257
000 350 7123	T40136 66	000625 036211	T58394 32	002 980 9502	T84758 178
000 350 8023	T38926 66	000625 036212	T58413 33	002 981 1105	T60952 262
(000 350 8023/SP)	T45741 97	000625 036214	T58390 33	002 981 1605	T65012 265
000 350 8123	T18701 93	000720 030313	T45155 261	002 981 2605	T65012 265
000 352 0114	T56273 255	000914 006109	T15169 267	002 981 4581	T38393 264
000 353 1450	T18705 36	000933 010145	T19642 190	002 981 4681	T38391 259
000 353 1550	T18705 36	000960 012147	T19173 192	002 981 5280	T81537 262
000 353 1585	T59781 86	000988 036100	T94208 203	002 981 5912	T45205 141
000 353 1685	T18851 86	001 260 3557	T45491 275	002 981 6012	T45205 141
000 353 1785	T61853 85	001 260 4757	T45491 275	002 981 6112	T49245 145
000 353 1885	T61849 85	001 260 4963	T69388 56	002 981 6312	T45205 141
000 423 0230	T93840 107	001 260 8457	T45491 275	002 981 7512	T49258 58
000 430 3568	T94241 180	001 260 8463	T67825 57	002 981 7781	T81537 262
000 430 3895	T77457 156	001 295 6707	T93709 57	002 981 7905	T22624 260
000 430 5495	T77457 156	001 540 5217	T76135 267	002 981 7981	T63534 260
000 435 0413	T41629 113	001 980 6702	T81546 266	002 981 8125	T58394 32
000 586 1235	T64873 179	001 980 6902	T84239 258	002 981 8181	T61826 263
000 821 0081	T76135 267	001 981 0001	T70993 58	002 981 8925	T93476 32
000 980 9702	T56273 255	001 981 0005	T84239 258	002 981 9501	T38061 57
000 981 1787	T51406 149	001 981 1701	T38065 58	002 992 1501	T93577 37
000 981 4186	T15153 150	001 981 2287	T11445 150	002 997 4248	T64126 152
000 981 4218	T60469 265	(001 981 2287/R)	T15759 149	002460 088080	T93584 125
000 981 4386	T15153 150	001 981 2787	T12303 150	003 260 3963	T67825 57
000 981 5111	T85440 142	001 981 3087	T16893 150	003 420 5120	T93840 107
000 981 6005	T84239 258	001 981 3105	T65714 35	003 460 1980	T93584 125
000 981 6505	T38068 263	001 981 3187	T16893 150	003 460 5080	T93584 125
000 981 7405	T61957 265	001 981 3287	T16893 150	003 981 1205	T56481 264
000 981 7705	T38068 263	001 981 4805	T61957 265	003 981 1701	T70993 58



OEM no.	TAS no. Pag.	OEM no.	TAS no. Pag.	OEM no.	TAS no. Pag.
003 981 1905	T56481 264	005 981 8405	T81544 255	007993 050200	T49964 110
003 981 2605	T56273 255	005 981 8505	T81544 255	008 542 7118	T73946 198
003 981 2805	T56273 255	005 981 8605	T81546 266	008 981 0305	T60469 265
003 981 2905	T60460 265	005 981 9905	T81546 266	008 981 1325	T47537 34
003 981 3005	T60469 265	005 990 5304	T19207 192	008 981 2805	T39607 258
003 981 3205	T60469 265	005 997 6736	T68387 204	008 981 3025	T47545 33
003 981 4105	T60975 263	005 997 6747	T56480 161	008 981 3425	T57249 32
003 981 4525	T58390 33	005 997 6947	T56480 161	008 981 5201	T65728 35
003 981 4925	T58390 33	005 997 7647	T56480 161	008 981 5425	T57249 32
003 981 6805	T94111 256	006 542 5218	T73946 198	008 981 8305	T60975 263
003 981 8205	T60975 263	006 981 0105	T81544 255	008 981 8310	T46634 145
003 981 8805	T58400 260	006 981 0405	T56291 255	008 981 8510	T56487 147
003 981 8905	T58400 260	006 981 1705	T58371 264	008 981 9210	T55466 145
003 981 9001	T65001 57	006 981 1901	T70993 58	008 981 9310	T46626 146
003 981 9005	T58400 260	006 981 1905	T58371 264	008 981 9410	T67089 146
004 262 0062	T15273 278	006 981 2801	T65728 35	008 981 9501	T38077 58
004 420 4420	T93840 107	006 981 3405	T58375 264	008 981 9525	T65695 35
004 540 7481	T84060 277	006 981 3505	T58375 264	008 981 9810	T56487 147
004 542 5018	T73952 275	006 981 4205	T55902 258	008 997 0347	T56493 162
004 981 0605	T94111 256	006 981 4305	T65714 35	008 997 7545	T64126 152
004 981 0905	T54160 256	006 981 5305	T65714 35	009 981 0010	T46634 145
004 981 2105	T54147 255	006 981 5405	T55902 258	009 981 0305	T55902 258
004 981 2125	T93476 32	006 981 5505	T56291 255	009 981 0325	T65697 35
004 981 3101	T65728 35	006 981 7605	T75384 265	009 981 0510	T65699 34
004 981 3301	T65728 35	006 981 8805	T60975 263	009 981 0605	T55915 266
004 981 4905	T54147 255	006 994 9941	T50021 195	009 981 1005	T55915 266
004 981 7405	T56291 255	006 997 6447	T22839 157	009 981 1510	T46626 146
004 981 8525	T22628 33	006888 003011	T85476 134	009 981 1610	T67089 146
004 981 8925	T22628 33	007 542 2418	T73946 198	009 981 1910	T58362 144
004 981 9325	T22628 33	007 542 7418	T75152 198	009 981 3325	T65734 33
004 997 2248	T57208 164	007 981 0005	T54147 255	009 981 3425	T65734 33
005 420 0720	T93831 107	007 981 0201	T65132 58	009 981 3525	T65734 33
005 420 4320	T93831 107	007 981 0305	T94111 256	009 981 3625	T65734 33
005 420 4920	T93831 107	007 981 0525	T49218 32	009 981 4305	T73116 266
005 420 5120	T93831 107	007 981 4210	T46634 145	009 981 4510	T58362 144
005 420 7920	T93840 107	007 981 5305	T84240 256	009 981 4705	T55915 266
005 420 8120	T93831 107	007 981 5701	T65728 35	009 981 5525	T49218 32
005 420 9320	T93840 107	007 981 7801	T65001 57	009 981 6205	T55915 266
005 981 2405	T84239 258	007 981 7901	T65001 57	009 981 6905	T58375 264
005 981 2505	T84239 258	007 994 0041	T50005 196	009 981 8305	T45155 261
005 981 4605	T58400 260	007 994 1841	T50021 195	009 981 8905	T45155 261
005 981 4705	T60975 263	007 997 3847	T56493 162	009 981 9005	T45155 261
005 981 4905	T56273 255	007 997 3947	T38573 162	009 981 9805	T45155 261
005 981 5505	T75384 265	007 997 5047	T38573 162	009 997 0446	T38573 162
005 981 5925	T58413 33	007 997 5147	T38346 159	009 997 0646	T56493 162
005 981 6025	T58413 33	007 997 8446	T56494 160	009 997 1446	T38346 159
005 981 6905	T75384 265	007603 024105	T49308 278	009 997 9146	T38574 158
005 981 8305	T81546 266	007603 042101	T57280 194	010 981 4901	T49258 58



OEM no.	TAS no. Pag.	OEM no.	TAS no. Pag.	OEM no.	TAS no. Pag.
010 981 5310	T46615 147	013 981 8505	T38378 261	015 981 7605	T38690 259
010 981 5905	T55902 258	013 981 9905	T38378 261	015 981 7705	T39606 261
010 981 6305	T55902 258	013 997 0048	T61944 166	015 981 9005	T37813 259
010 981 6410	T46615 147	013 997 0148	T57257 165	015 981 9505	T37799 267
010 981 8401	T49258 58	013 997 2646	T45221 158	015 981 9810	T46608 148
010 981 8425	T57249 32	013 997 4947	T83369 158	015 997 2748	T57261 165
010 981 9025	T57249 32	013 997 5547	T22842 162	015 997 2848	T49901 165
010 997 3746	T83369 158	013 997 5647	T22845 163	015 997 4048	T55299 166
010 997 5346	T83369 158	013 997 6547	T82143 157	015 997 4247	T22845 163
010 997 6046	T77180 156	013 997 7247	T22842 162	015 997 4747	T18586 161
010 997 6246	T77183 156	013 997 7347	T22845 163	015 997 6947	T22716 162
011 981 0705	T58371 264	013 997 7548	T50074 166	015 997 7746	T67200 161
011 981 1305	T22631 266	013 997 9347	T82143 157	015 997 7846	T43835 163
011 981 1905	T37781 261	013 997 9447	T82143 157	016 981 0005	T61866 260
011 981 2305	T73116 266	014 981 0705	T38690 259	016 981 0010	T46608 148
011 981 3605	T73116 266	014 981 0905	T38378 261	016 981 0105	T61866 260
011 981 7605	T22624 260	014 981 1005	T38378 261	016 981 0205	T61866 260
011 997 3746	T65126 157	014 981 1405	T37813 259	016 981 0305	T61866 260
011 997 6847	T83369 158	014 981 1505	T38690 259	016 981 0405	T70694 255
011 997 7047	T38574 158	014 981 2005	T63139 264	016 981 0505	T70694 255
012 542 5617	T70074 275	014 981 2105	T63139 264	016 981 0605	T70694 255
012 542 7117	T70074 275	014 981 2205	T56241 266	016 981 0705	T70694 255
012 981 3605	T52390 259	014 981 2605	T37799 267	016 981 1205	T22649 262
012 981 3705	T52395 263	014 981 3005	T38690 259	016 981 1505	T70694 255
012 981 7205	T37813 259	014 981 3105	T39606 261	016 981 1605	T61866 260
012 981 7405	T37813 259	014 981 3205	T81544 255	016 981 3005	T75625 256
012 981 7505	T22649 262	014 981 3905	T38378 261	016 981 3105	T75625 256
012 981 8105	T22645 257	014 981 6105	T22617 262	016 981 4405	T63534 260
012 981 8205	T22645 257	014 981 6310	T85440 142	016 981 5605	T70139 259
012 981 8405	T56241 266	014 981 7805	T58518 263	016 981 7205	T75632 258
012 981 8910	T46630 142	014 981 7905	T58515 260	016 981 7305	T75625 256
012 981 9010	T46630 142	014 981 8805	T55470 257	016 981 7881	T63534 260
012 981 9110	T46626 146	014 997 1246	T19718 160	016 997 4048	T64126 152
012 981 9205	T22649 262	014 997 1947	T22842 162	016 997 6647	T56480 161
012 981 9310	T46615 147	014 997 3647	T22848 160	016 997 6747	T58426 161
012 981 9405	T22649 262	014 997 4346	T38346 159	017 981 1305	T52217 257
012 981 9410	T67089 146	014 997 5148	T50089 165	017 981 2205	T37781 261
012 997 3347	T22839 157	015 981 1605	T22645 257	017 981 2305	T37799 267
013 981 0210	T46630 142	015 981 1705	T55470 257	017 981 3510	T51992 144
013 981 0305	T38385 257	015 981 2005	T38690 259	017 981 3610	T51994 144
013 981 0405	T38395 258	015 981 2605	T37944 256	017 981 3710	T51996 142
013 981 0505	T22645 257	015 981 3405	T75632 258	017 981 3810	T51998 143
013 981 0605	T37813 259	015 981 3805	T75632 258	017 981 5010	T49245 145
013 981 1105	T22645 257	015 981 4005	T52395 263	017 981 5105	T37799 267
013 981 1710	T60990 145	015 981 4110	T56498 142	017 981 5110	T49245 145
013 981 1810	T60990 145	015 981 5605	T75632 258	017 981 5210	T49303 143
013 981 2610	T60990 145	015 981 6105	T37799 267	017 981 5310	T49303 143
013 981 7305	T22649 262	015 981 6205	T37781 261	017 981 5610	T49233 144





OEM no.	TAS no. Pag.	OEM no.	TAS no. Pag.	OEM no.	TAS no. Pag.
017 981 5705	T39606 261	019 981 4410	T46634 145	022 981 7910	T57217 146
017 981 5710	T49233 144	019 981 5310	T49252 143	022 981 8510	T57225 147
017 981 6010	T45570 141	019 981 5710	T49252 143	022 997 4248	T50027 166
017 981 6110	T45570 141	019 981 5810	T52402 143	022 997 7748	T76483 152
017 981 7105	T38268 261	019 981 6010	T52402 143	023 981 1210	T56551 141
017 981 7810	T46626 146	019 981 6105	T81537 262	023 981 2910	T49252 143
017 981 7905	T56291 255	019 981 6210	T56487 147	023 981 3810	T49240 147
017 981 7910	T54685 148	019 981 9010	T58423 141	023 981 5110	T56551 141
017 981 8305	T67028 190	019 981 9110	T58362 144	023 981 5210	T57225 147
017 997 1847	T49953 157	019 981 9210	T56551 141	023 981 8210	T49233 144
017 997 2647	T38572 162	019 981 9810	T58422 148	023 981 8510	T49252 143
017 997 2747	T38573 162	019 981 9910	T58422 148	023 997 1048	T76483 152
017 997 2847	T82146 160	019 997 0347	T22850 158	023 997 1647	T43835 163
017 997 3047	T19636 159	019 997 0547	T22850 158	023 997 5548	T61923 194
017 997 3147	T38346 159	019 997 2147	T22833 159	023 997 6048	T61923 194
017 997 5710	T49233 144	019 997 7248	T49931 152	023 997 7748	T76483 152
017 997 8147	T38346 159	019 997 8348	T63561 165	023 997 7847	T22850 158
017 997 9947	T52380 159	020 981 0010	T58423 141	023 997 8547	T56494 160
018 981 0110	T49227 142	020 981 0110	T56551 141	023 997 8847	T56494 160
018 981 0410	T54685 148	020 997 0647	T38574 158	024 981 2410	T57231 147
018 981 3010	T49227 142	020 997 3947	T82143 157	024 997 2747	T45225 158
018 981 3610	T49227 142	020 997 6447	T56494 160	024 997 3247	T45225 158
018 981 5310	T49245 145	020 997 6647	T22839 157	024 997 8347	T22848 160
018 981 5610	T49303 143	020 997 6747	T22848 160	027 997 2248	T64126 152
018 981 5710	T45570 141	020 997 7247	T45225 158	027 997 3048	T61923 194
018 981 5810	T49240 147	020 997 7848	T49932 166	028 997 2248	T49931 152
018 981 6410	T57122 146	020 997 8548	T49901 165	028 997 2348	T57208 164
018 981 6610	T46615 147	020 997 8648	T50089 165	029 997 5748	T50112 164
018 981 6805	T85628 262	020 997 8948	T50074 166	06 02191 0523	T19023 191
018 981 7410	T54685 148	020 997 9947	T56493 162	070852 055000	T15375 123
018 981 7510	T46626 146	021 981 1710	T58422 148	070852 060000	T16989 121
018 981 7610	T55466 145	021 981 2205	T55470 257	070952 060102	T70569 134
018 981 7910	T54685 148	021 981 5210	T67005 144	115 997 0032	T49313 176
018 981 8110	T55466 145	021 981 9410	T56487 147	124 997 0132	T49309 176
018 981 8610	T46608 148	021 997 0047	T56493 162	1324 302 016	T85487 128
018 981 8710	T46608 148	021 997 1747	T45221 158	1530 0027 510	T41629 113
018 981 9510	T49233 144	021 997 2547	T45221 158	1530 0420 610	T77457 156
018 981 9610	T49240 147	022 981 2010	T67085 146	1530.01834	T73650 198
018 997 4947	T52380 159	022 981 2110	T67085 146	210 997 0032	T49309 176
018 997 5147	T56480 161	022 981 2210	T67044 143	210 997 0132	T49313 176
018 997 7147	T63630 160	022 981 2310	T67044 143	300 350 0039	T54693 74
018 997 7347	T52380 159	022 981 5310	T57217 146	301 350 0539	T63113 81
019 981 0510	T56498 142	022 981 5410	T57225 147	301 350 0727	T51411 59
019 981 0610	T56487 147	022 981 5510	T57231 147	301 350 1339	T63113 81
019 981 0810	T67089 146	022 981 5610	T57279 145	301 350 2339	T70053 74
019 981 1310	T46630 142	022 981 5810	T57225 147	301 350 2439	T15463 74
019 981 2310	T55466 145	022 981 5910	T57231 147	301 353 0020	T46657 104
019 981 3410	T54685 148	022 981 6010	T57279 145	301 353 0115	T51937 101



OEM no.	TAS no. Pag.	OEM no.	TAS no. Pag.	OEM no.	TAS no. Pag.
302 260 1644	T08534 18	314 262 0902	T08301 126	322 262 0434	T08190 218
302 262 0312	T08278 13	314 262 1123	T08305 249	322 262 0435	T07947 229
302 262 0535	T08280 233	314 262 1223	T08305 249	322 262 0505	T01158 136
302 262 0537	T08595 241	314 262 1434	T08306 217	322 262 0511	T08192 9
302 262 1502	T08281 127	314 262 1534	T08308 218	322 262 0635	T07947 229
302 263 0410	T08537 48	314 263 0210	T08310 48	322 262 0705	T01158 136
302 350 1139	T63113 81	314 263 0514	T08316 28	322 262 0735	T07949 229
302 350 2023	T08028 64	314 263 0610	T08310 48	322 262 0802	T01155 125
302 353 0014	T01143 89	314 263 0614	T08316 28	322 262 1150	T08194 39
302 353 0015	T01144 100	314 263 0710	T08310 48	322 262 4050	T08196 39
304 353 0020	T17844 102	314 263 1002	T08313 51	322 262 5650	T08194 39
304 353 0162	T17846 270	314 263 1214	T08316 28	322 262 6550	T08196 39
304 353 0362	T17847 272	314 263 1414	T08316 28	322 263 0010	T08205 48
305 350 0139	T17545 80	315 353 0045	T15505 114	322 263 0013	T08203 16
305 350 0339	T14814 79	315 354 0510	T08944 70	322 263 0114	T07565 28
305 350 0539	T09007 75	315 354 0610	T08944 70	322 263 0202	T08198 50
305 350 0639	T11045 78	318 350 1439	T53556 73	322 263 0302	T08198 50
305 350 1639	T17545 80	320 357 0053	T15506 54	322 263 0313	T08203 16
307 260 1644	T08322 24	321 262 0212	T08188 13	322 263 0314	T07565 28
307 260 3544	T08322 24	321 262 0674	T08176 177	322 263 0333	T08201 186
307 260 4244	T08322 24	321 262 0723	T01149 250	322 263 0433	T08201 186
307 262 0023	T08341 250	321 262 0774	T08177 177	322 263 0513	T08203 16
307 263 0110	T08284 47	321 262 0823	T01151 250	322 263 0514	T07565 28
307 263 0413	T08285 15	321 262 0940	T08178 200	322 263 0610	T08205 48
307 263 0513	T08285 15	321 262 1040	T08179 200	322 263 0614	T07565 28
307 263 0614	T08540 27	321 262 1123	T01149 250	322 350 1839	T08942 81
308 262 7002	T08301 126	321 262 1223	T01151 250	322 353 0015	T05823 100
308 353 0020	T09144 104	321 262 1835	T07949 229	322 353 0115	T05823 100
308676 012022	T19173 192	321 263 0502	T08198 50	322 353 0120	T01170 103
308748 006003	T72773 110	321 353 0115	T05823 100	322 353 0162	T01159 269
309 350 0239	T00093 73	321 993 0701	T08182 210	322 353 0615	T01166 100
309 350 0839	T00093 73	322 260 0325	T01153 184	322 353 0715	T05823 100
309 350 1139	T00093 73	322 260 0725	T01153 184	326 253 0314	T17848 90
309 350 1439	T00093 73	322 260 0825	T01153 184	326 353 0314	T17848 90
309 353 0115	T75990 99	322 260 1744	T01154 23	326 353 0414	T17848 90
(312 350 1739/PINION)	T05826 70	322 260 1835	T07949 229	326 354 0512	T15507 71
312 353 1224	T01147 270	322 260 1944	T08185 16	326 354 0612	T08945 72
314 260 0425	T08287 185	322 260 2044	T01154 23	326 354 0910	T15508 70
314 260 0725	T08287 185	322 260 2444	T08185 16	326 354 1012	T15507 71
314 260 2444	T08289 23	322 262 0005	T01158 136	326 354 1112	T08945 72
314 260 3644	T08293 17	322 262 0034	T08190 218	326 354 1410	T15508 70
314 262 0202	T08301 126	322 262 0045	T12469 114	327 353 0062	T08023 273
314 262 0302	T08301 126	322 262 0102	T01155 125	327 353 0162	T08025 271
314 262 0402	T08299 126	322 262 0112	T08188 13	327 353 0172	T15465 152
314 262 0502	T08301 126	322 262 0137	T01157 241	327 353 0586	T08029 59
314 262 0734	T08306 217	322 262 0211	T08192 9	327 353 2162	T08021 201
314 262 0802	T08299 126	322 262 0237	T07561 241	327 353 2462	T08022 200
314 262 0834	T08308 218	322 262 0412	T08188 13	327 353 3262	T08023 273



OEM no.	TAS no. Pag.	OEM no.	TAS no. Pag.	OEM no.	TAS no. Pag.
327 353 3962	T08023 273	340 263 0110	T07574 47	346 350 2739	T15373 77
327 353 4662	T08025 271	341 350 0739	T08942 81	346 350 2839	T18285 75
327 353 4762	T08025 271	343 254 0016	T82414 56	346 350 2939	T14290 78
327 353 4962	T08023 273	343 254 0216	T82414 56	346 350 3039	T09673 73
327 460 2208	T01160 210	343 281 1314	T16984 55	346 350 3539	T08965 79
327 460 2308	T01161 210	343 282 0545	T15510 114	346 350 3639	T14500 79
327 981 0305	T61957 265	343 283 1306	T15511 199	346 350 3739	T08965 79
327 990 0012	T75812 191	343 350 0039	T08954 82	346 350 3839	T75409 80
327 991 0060	T75814 167	343 350 0723	T15296 87	346 350 3939	T09526 75
335 353 0015	T17850 99	343 350 0923	T15784 93	346 350 4039	T09187 76
335 357 0001	T15509 109	343 350 1023	T15296 87	346 350 4139	T08963 77
335 357 0002	T15509 109	343 352 0016	T16986 113	346 350 4239	T09672 73
335 357 0101	T15509 109	343 353 0335	T15512 86	346 350 4339	T18023 75
335 357 0102	T15509 109	343 586 0135	T17862 92	346 350 4439	T16624 78
337 260 0525	T01162 184	344 350 0239	T63113 81	346 350 4639	T75409 80
337 260 1425	T01162 184	345 200 7724	T09001 113	346 350 4839	T15373 77
337 260 1625	T01162 184	345 350 0054	T51922 92	346 350 5639	T09526 75
337 260 2744	T08320 23	345 350 1323	T08028 64	346 350 5739	T09526 75
337 260 3044	T08320 23	345 353 7020	T01170 103	346 350 5939	T18023 75
337 260 3144	T08322 24	345 353 7120	T01170 103	346 350 6039	T18023 75
337 262 0023	T08323 249	345 981 7401	T38065 58	346 350 6139	T18285 75
337 262 0035	T08327 232	345 981 7501	T70993 58	346 350 6239	T09672 73
337 262 0140	T19426 200	345 981 8101	T38065 58	346 350 7433A	T85315 64
337 262 0223	T08323 249	346 336 0062	T15372 270	346 350 7639	T16624 78
337 262 0313	T08328 17	346 350 0128	T08957 105	346 350 7839	T75409 80
337 262 0335	T08330 232	346 350 0427	T12311 67	346 350 8039	T08965 79
337 262 0505	T08325 136	346 350 0443	T14764 123	346 350 8123	T12314 65
337 262 0635	T08327 232	346 350 0445	T14766 115	346 350 8139	T14500 79
337 262 0713	T08328 17	346 350 0454	T88695 61	(346 350 8223/CASE)	T19211 68
337 262 0735	T08330 232	346 350 0527	T15307 69	346 350 9523	T15296 87
337 262 1034	T08331 218	346 350 0545	T11848 116	346 350 9928	T11865 92
337 262 1234	T08331 218	346 350 0554	T09795 61	346 353 0072	T11231 152
337 263 0314	T07569 27	346 350 0645	T15651 115	346 353 0085	T08969 72
337 263 0513	T08335 16	346 350 0654	T88695 61	346 353 0114	T08981 91
337 263 0602	T08333 50	(346 350 0654/S)	T08962 168	346 353 0124	T08970 267
337 263 0610	T08337 47	346 350 1324	T15300 86	346 353 0126	T08971 122
337 263 0702	T08333 50	346 350 1445	T15154 116	346 353 0185	T15300 86
337 263 0713	T08335 16	346 350 1639	T09526 75	346 353 0224	T08972 268
337 263 0810	T08337 47	346 350 1739	T09187 76	346 353 0315	T08973 99
337 263 0814	T07569 27	346 350 1839	T09672 73	346 353 0326	T15297 122
337 283 5006	T15511 199	346 350 1939	T08963 77	346 353 0335	T15298 87
337 283 5150	T16979 35	346 350 2039	T18023 75	346 353 0362	T08976 274
340 262 0034	T08568 218	346 350 2139	T12312 76	346 353 0385	T15300 86
340 262 0134	T08568 218	346 350 2239	T15373 77	346 353 0420	T08979 103
340 262 0202	T07571 126	346 350 2327	T15307 69	346 353 0435	T14502 109
340 262 0402	T07571 126	346 350 2339	T18285 75	346 353 0450	T14768 39
340 262 0502	T07571 126	346 350 2439	T14290 78	346 353 0514	T08981 91
340 263 0010	T07574 47	346 350 2639	T12312 76	346 353 0515	T15299 100



OEM no.	TAS no. Pag.	OEM no.	TAS no. Pag.	OEM no.	TAS no. Pag.
346 353 0524	T19020 269	346 354 3017	T50151 213	355 350 1827	T14937 69
346 353 0562	T08984 269	346 354 3109	T19213 63	355 350 2939	T14814 79
346 353 0614	T08985 91	346 354 3212	T51401 96	355 350 3039	T11045 78
346 353 0625	T14773 123	346 354 3712	T63411 95	355 350 3239	T09007 75
346 353 0635	T19079 109	346 354 4209	T19214 64	355 350 3639	T09077 78
346 353 0650	T14770 38	346 354 5709	T19882 64	355 350 3739	T09006 76
346 353 0735	T15298 87	346 354 9709	T39259 63	355 350 3839	T09189 75
346 353 0736	T08987 102	346 356 0315	T19883 269	355 350 3939	T09189 75
346 353 0762	T14980 273	346 356 1415	T19883 269	355 350 4039	T09006 76
346 353 0815	T08973 99	346 357 0601	T20034 108	355 350 4139	T09077 78
346 353 0825	T14813 121	346 357 1801	T20034 108	355 350 4639	T09007 75
346 353 0836	T08987 102	(346 586 0035/G)	T09797 59	355 350 4739	T09009 76
346 353 0862	T08989 274	346 586 0134	T88695 61	355 350 4839	T14905 79
346 353 0925	T14449 122	346 586 0135	T08996 61	355 350 4939	T15652 80
346 353 0950	T08990 36	(346 586 0135/G)	T08998 59	355 350 5139	T11045 78
346 353 1014	T08985 91	346 990 2501	T19171 192	355 350 5239	T14814 79
346 353 1050	T14770 38	350 350 0223	T08028 64	355 350 7623	T12318 65
346 353 1115	T15299 100	352 353 0024	T01147 270	355 353 0014	T09013 89
346 353 1136	T08987 102	354 350 0123	T08028 64	355 353 0026	T09011 121
346 353 1451	T82166 201	354 350 0823	T08028 64	355 353 0085	T12316 71
346 353 1585	T15300 86	354 353 0014	T01164 90	355 353 0125	T11132 122
346 353 1762	T08976 274	354 353 0015	T01165 100	355 353 0126	T14931 124
346 353 1785	T15300 86	354 353 0074	T08030 169	355 353 0135	T14907 108
346 353 1914	T08985 91	354 353 0086	T08029 59	355 353 0150	T11446 38
346 353 2251	T82165 201	354 353 0174	T08030 169	355 353 0176	T09012 270
346 353 2262	T91057 272	355 030 2203	T08999 112	355 353 0214	T09013 89
346 353 2462	T14980 273	355 030 2703	T08999 112	355 353 0215	T09015 98
346 353 2551	T08991 204	355 132 0215	T09000 32	355 353 0225	T11991 123
346 353 2562	T08989 274	355 200 1124	T09001 113	355 353 0234	T14909 70
346 353 3251	T08991 204	355 350 0040	T15329 93	355 353 0235	T14933 87
346 353 9850	T20182 106	355 350 0054	T18449 60	355 353 0250	T09017 38
346 354 0412	T08992 95	355 350 0126	T09015 98	355 353 0315	T09019 99
346 354 0417	T08993 211	355 350 0128	T09004 105	355 353 0325	T11133 122
346 354 0512	T11227 95	355 350 0227	T09075 69	355 353 0362	T09507 273
346 354 0517	T09674 211	355 350 0254	T18449 60	355 353 0462	T09160 274
346 354 0909	T09241 63	(355 350 0254/G)	T18450 59	355 353 0562	T09020 269
346 354 0917	T18877 211	355 350 0324	T15407 85	355 353 0615	T12317 98
346 354 1109	T08995 63	355 350 0327	T14937 69	355 353 0620	T09021 102
346 354 1362	T11113 268	355 350 0354	T15768 61	355 353 0735	T19215 109
346 354 1412	T20183 95	(355 350 0354/G)	T15769 60	355 353 0736	T14935 101
346 354 1717	T19076 214	(355 350 0354/S)	T15770 169	355 353 0750	T09024 37
346 354 1917	T60920 213	355 350 0454	T51370 61	355 353 0835	T20616 108
346 354 2409	T19077 62	(355 350 0454/G)	T51377 60	355 353 0862	T61084 274
346 354 2417	T18740 214	(355 350 0454/S)	T19658 169	355 353 0935	T14933 87
346 354 2517	T39260 212	355 350 0624	T15407 85	355 353 0950	T09017 38
346 354 2612	T19078 96	355 350 0645	T15533 115	355 353 1036	T14935 101
346 354 3009	T16987 63	355 350 0745	T14903 115	355 353 1050	T11446 38
346 354 3012	T20184 96	355 350 1415	T14930 85	355 353 1062	T09507 273





OEM no.	TAS no. Pag.	OEM no.	TAS no. Pag.	OEM no.	TAS no. Pag.
355 353 1115	T14936 98	383 262 0033	T08344 186	385 353 1262	T14460 271
355 353 1162	T09509 273	383 262 0134	T08345 219	385 353 2362	T11711 273
355 353 1236	T14935 101	383 262 0235	T08346 232	385 353 3062	T11711 273
355 353 1862	T09160 274	383 262 0802	T08601 126	385 353 4062	T11711 273
355 353 2062	T61084 274	383 263 0031	T08603 183	385 990 0179	T15277 267
355 353 2262	T09507 273	383 263 0202	T08347 51	386 350 0040	T09031 83
355 353 2362	T09509 273	383 282 0262	T49324 279	386 350 7823	T51389 64
355 353 2662	T83195 274	383 350 0039	T08942 81	386 981 0005	T81546 266
355 353 6051	T09027 206	383 350 0639	T63113 81	386 981 0105	T81544 255
355 353 9850	T20189 106	383 353 0120	T01170 103	386 981 7105	T56481 264
355 354 0162	T09028 204	384 350 0039	T56709 81	386 981 7405	T56481 264
355 354 0317	T18451 210	385 260 0390	T11134 154	386 990 0201	T75828 191
355 354 0417	T18719 211	385 260 0861	T15515 170	386 990 0301	T75829 192
355 354 0462	T11113 268	385 260 1345	T15268 219	387 252 0208	T20574 254
355 354 0709	T11229 62	385 260 1444	T15513 13	387 260 2873	T44595 39
355 354 1312	T11227 95	385 260 1544	T15514 17	387 260 2873/M	T44012 140
355 354 1809	T11229 62	385 260 1761	T15515 170	387 262 0223	T12201 251
355 354 3012	T39258 96	385 260 3061	T15515 170	387 262 0473	T67705 195
355 356 0126	T14911 124	385 260 3245	T15268 219	387 262 0523	T12201 251
355 356 0915	T54592 206	385 262 0008	T19888 189	387 262 0623	T15654 252
355 356 1215	T54592 206	385 262 0109	T15270 213	387 262 0693	T14489 208
355 981 0187	T51406 149	385 262 0137	T15581 240	387 262 0734	T15471 225
357 350 0039	T09526 75	385 262 0145	T44025 115	387 262 0793	T14487 209
357 350 0139	T17545 80	385 262 0152	T15271 204	387 262 0893	T14487 209
357 350 0539	T09007 75	385 262 0208	T19888 189	387 262 0993	T14489 208
357 350 0639	T14814 79	385 262 0407	T15278 173	387 262 1093	T14489 208
357 350 0739	T17545 80	385 262 0434	T15580 219	387 262 1137/RING	T11712 243
357 350 1639	T17545 80	385 262 0637	T15274 241	387 262 1301	T66679 125
357 990 0079	T15277 267	385 262 0645	T44025 115	387 262 1523	T12201 251
358 353 0015	T01166 100	385 262 0674	T55853 177	387 262 1735	T12281 235
360 353 0020	T01167 104	385 262 0923	T15272 250	387 262 1813	T16894 12
363 411 0111	T16993 178	385 262 1035	T15408 229	387 262 2073	T50005 196
364 350 0239	T08942 81	385 262 1152	T15273 278	387 262 2114	T16898 24
366 354 2512	T17787 72	385 262 1437	T15274 241	387 262 2173	T50006 195
366 354 2610	T17788 71	385 262 1534	T15276 218	387 262 2273	T50005 196
366 354 3510	T17788 71	385 262 1537	T15581 240	387 262 2734	T15467 224
371 353 0025	T11132 122	385 262 2502	T15618 128	387 262 3134	T15473 224
378 350 0039	T53556 73	385 262 2602	T15516 128	387 262 3234	T16895 225
380 353 0014	T11992 90	385 350 0040	T14457 84	387 262 3534	T16896 225
381 262 0023	T08341 250	385 350 3639	T14458 81	387 262 3634	T16896 225
381 262 0037	T08595 241	385 350 4339	T56709 81	387 262 3814	T16898 24
381 262 0102	T08597 126	385 351 0072	T15465 152	387 262 4131	T15467 224
381 262 0135	T08342 232	385 351 0172	T15465 152	387 262 4134	T15467 224
381 262 0223	T68586 246	385 351 0572	T11231 152	387 262 4534	T15467 224
381 262 0523	T68586 246	385 353 0085	T19067 86	387 262 4834	T15470 224
381 981 0087	T15266 151	385 353 0114	T46660 91	387 262 5034	T15471 225
(381 981 0087/R)	T15267 149	385 353 0115	T19068 98	387 262 5134	T15473 224
383 262 0023	T08343 250	385 353 0835	T20616 108	387 262 8673	T49961 197



OEM no.	TAS no. Pag.	OEM no.	TAS no. Pag.	OEM no.	TAS no. Pag.
387 262 8773	T49960 197	389 262 0034	T15552 220	389 262 0737/RING	T11712 243
387 264 0105	T20290 199	389 262 0035	T12281 235	389 262 0773	T39049 134
387 264 0405	T20290 199	389 262 0037	T88628 245	389 262 0806	T12306 254
387 265 0049	T14815 202	389 262 0037/RING	T12204 243	389 262 0808	T17255 189
387 267 0250	T15517 36	389 262 0040	T17263 231	389 262 0809	T15411 211
387 267 0618	T50029 168	389 262 0050	T17369 37	389 262 0813	T12206 18
387 267 0650	T15517 36	389 262 0062	T15535 277	389 262 0814	T44042 25
387 267 0918	T50029 168	389 262 0116	T53139 30	389 262 0816	T53139 30
387 268 0773	T19629 196	389 262 0123	T17600 253	389 262 0851	T19630 208
387 268 2374	T39627 167	389 262 0135	T12340 230	389 262 0909	T15411 211
387 350 0040	T09031 83	389 262 0137	T88628 245	389 262 0913	T12206 18
387 350 1323	T12318 65	389 262 0137/RING	T12204 243	389 262 0914	T44042 25
387 350 1523	T12320 65	389 262 0150	T61840 36	389 262 0923	T15541 249
387 350 5923	T12320 65	389 262 0162	T15157 204	389 262 0934	T17268 226
(387 350 5923/CASE)	T14256 69	389 262 0208	T12341 189	389 262 0945	T49978 117
387 350 9423	T15409 88	389 262 0209	T11790 212	389 262 0973	T39045 110
387 350 9823	T14928 87	389 262 0210	T13517 27	389 262 1013	T17265 17
387 586 0035	T09031 83	389 262 0223	T12221 248	389 262 1033	T18840 185
387 981 0187	T14424 150	389 262 0251	T39050 205	389 262 1110	T13517 27
387 993 2101	T68238 209	389 262 0262	T15158 277	389 262 1112	T16905 12
387 993 2201	T68241 209	389 262 0293	T14493 209	389 262 1114	T44042 25
389 260 0150	T20414 179	389 262 0309	T16903 212	389 262 1134	T44051 216
389 260 0297	T12300 175	389 262 0312	T12282 12	389 262 1135	T68471 228
389 260 0397	T16900 175	389 262 0313	T15536 18	389 262 1137	T88630 246
(389 260 0397/SHAFT)	T16901 168	389 262 0333	T15538 185	389 262 1162	T15159 277
389 260 0490	T11135 154	389 262 0362	T39369 279	389 262 1205	T12207 137
389 260 0497	T15155 176	389 262 0407	T15166 168	389 262 1210	T18902 42
(389 260 0497/G)	T15156 173	389 262 0409	T15410 212	389 262 1212	T12205 12
389 260 0590	T11135 154	389 262 0411	T17598 9	389 262 1223	T12310 252
389 260 0661	T17261 170	389 262 0416	T53139 30	389 262 1234	T12228 224
389 260 0690	T11135 154	389 262 0435	T17264 231	389 262 1302	T17380 52
389 260 0790	T39053 155	389 262 0445	T14494 116	389 262 1305	T17266 138
389 260 0936	T17262 227	389 262 0534	T15655 225	389 262 1312	T12205 12
389 260 2036	T14492 227	389 262 0535	T18364 236	389 262 1313	T12206 18
389 260 5719	T15534 24	389 262 0537	T88628 245	389 262 1323	T15317 252
389 260 8961	T12339 170	389 262 0537/RING	T12204 243	389 262 1337	T88631 246
389 261 0420	T18838 55	389 262 0545	T63242 116	389 262 1337/RING	T12209 244
389 261 0520	T18838 55	389 262 0562	T15157 204	389 262 1362	T15159 277
389 261 0665	T49970 154	389 262 0606	T16902 173	389 262 1412	T17267 13
389 261 0765	T49970 154	389 262 0623	T12220 251	389 262 1413	T12206 18
389 261 1920	T18838 55	389 262 0635	T14495 235	389 262 1425	T39048 171
389 261 3318	T18839 55	389 262 0637	T88631 246	389 262 1437	T88630 246
389 261 4518	T18901 55	389 262 0637/RING	T12209 244	389 262 1454	T19632 207
389 262 0003	T49962 132	389 262 0645	T50088 117	389 262 1462	T15159 277
389 262 0012	T12282 12	389 262 0713	T16904 18	389 262 1505	T12207 137
389 262 0013	T15536 18	389 262 0716	T53139 30	389 262 1510	T16906 26
389 262 0023	T12208 249	389 262 0723	T12218 252	389 262 1511	T15539 9
389 262 0033	T15538 185	389 262 0737	T88630 246	389 262 1523	T17600 253



OEM no.	TAS no. Pag.	OEM no.	TAS no. Pag.	OEM no.	TAS no. Pag.
389 262 1534	T12228 224	389 262 2737	T88630 246	389 262 5552	T19634 207
389 262 1535	T12342 235	389 262 2810	T15160 42	389 262 5601	T49962 132
389 262 1605	T19848 138	389 262 2835	T17378 235	389 262 5610	T12227 26
389 262 1610	T12222 26	389 262 2901	T12217 131	389 262 5634	T12228 224
389 262 1611	T15539 9	389 262 2910	T15544 43	389 262 5635	T56717 237
389 262 1615	T61898 28	389 262 2923	T12218 252	389 262 5734	T51686 217
389 262 1650	T17369 37	389 262 2923/M	T44645 247	389 262 5752	T20225 207
389 262 1710	T12222 26	389 262 3013	T18841 24	389 262 5852	T19070 206
389 262 1723	T12208 249	389 262 3023	T12220 251	389 262 5952	T19070 206
389 262 1733	T17371 187	389 262 3137-OLD	T88631 246	389 262 6201	T18845 132
389 262 1813	T15518 19	389 262 3205	T53120 137	389 262 6301	T17832 132
389 262 1823	T15541 249	389 262 3237-OLD	T88630 246	389 262 6462	T15157 204
389 262 1833	T19069 186	389 262 3311	T59115 10	389 262 6501	T15525 131
389 262 1854	T15519 208	389 262 3335	T56717 237	389 262 6502	T53130 130
389 262 1862	T56713 205	389 262 3411	T59115 10	389 262 6601	T15548 132
389 262 1934	T17268 226	389 262 3473	T62060 196	389 262 6602	T53130 130
389 262 1954	T19632 207	389 262 3552	T50019 280	389 262 7035	T56715 231
389 262 2011	T17375 10	389 262 3613	T53132 20	389 262 7601	T38535 133
389 262 2013	T15534 24	389 262 3701	T15547 131	389 262 7710	T12231 42
389 262 2023	T44040 253	389 262 3710	T12222 26	389 262 7802	T61890 130
389 262 2033	T15520 187	389 262 3713	T18841 24	389 262 7902	T61890 130
389 262 2035	T12224 236	389 262 3754	T50020 208	389 262 7910	T15162 25
389 262 2054	T19632 207	389 262 3810	T15161 25	389 262 7954	T19635 206
389 262 2113	T15542 17	389 262 3901	T12283 131	389 262 8002	T61893 130
389 262 2123	T44038 254	389 262 3910	T38569 45	389 262 8102	T61893 130
389 262 2133	T45301 187	389 262 3934	T12228 224	389 262 8201	T17831 132
389 262 2155	T20224 208	389 262 4005	T53120 137	389 262 8234	T61913 221
389 262 2210	T12308 42	389 262 4034	T14496 226	389 262 8301	T17832 132
389 262 2223	T12220 251	389 262 4123	T15317 252	389 262 8334	T61910 221
389 262 2233	T61918 188	389 262 4135	T56715 231	389 262 8610	T15163 27
389 262 2310	T12226 27	389 262 4235	T61921 230	389 262 9134	T12232 226
389 262 2334	T17268 226	389 262 4313	T53132 20	389 262 9234	T15526 220
389 262 2405	T18025 138	389 262 4410	T12227 26	389 262 9454	T49970 154
389 262 2434	T12228 224	389 262 4413	T53132 20	389 262 9655	T20224 208
389 262 2437	T88631 246	389 262 4434	T18365 220	389 262 9734	T61896 223
389 262 2511	T59115 10	389 262 4435	T51697 236	389 262 9834	T60449 222
389 262 2535	T15543 236	389 262 4452	T19633 207	389 262 9934	T51686 217
389 262 2537	T88631 246	389 262 4505	T53120 137	389 263 0062	T15316 268
389 262 2537/RING	T12209 244	389 262 4605	T53120 137	389 263 0116	T56722 31
389 262 2550	T17369 37	389 262 4635	T15521 236	389 263 0310	T18903 46
389 262 2623	T12310 252	389 262 4735	T15521 236	389 263 0410	T17602 45
389 262 2705	T17383 139	389 262 4935	T12224 236	389 263 0415	T61936 29
389 262 2710	T12231 42	389 262 5034	T12284 217	389 263 0610	T16908 46
389 262 2711	T17375 10	389 262 5101	T15525 131	389 263 0802	T15549 51
389 262 2712	T59106 15	389 262 5335	T54698 234	389 263 0815	T61936 29
389 262 2723	T15317 252	389 262 5410	T16906 26	389 263 0850	T17269 36
389 262 2733	T61918 188	389 262 5434	T15522 219	389 263 0902	T17270 51
389 262 2735	T68478 228	389 262 5510	T12226 27	389 263 0910	T18903 46



OEM no.	TAS no. Pag.	OEM no.	TAS no. Pag.	OEM no.	TAS no. Pag.
389 263 0913	T15550 21	389 269 0210	T17548 199	425 262 0137	T15581 240
389 263 0915	T61936 29	389 269 0310	T17548 199	440 260 0097	T15278 173
389 263 1013	T15550 21	389 269 0706	T39052 156	(440 260 0097/G)	T15279 172
389 263 1031	T17379 184	389 269 0810	T60251 156	(440 260 0097/SHAFT)	T15280 169
389 263 1110	T12234 46	389 269 1206	T39052 156	460 586 0135	T76723 84
389 263 1113	T17271 21	389 269 1210	T17548 199	463 280 0040	T76723 84
389 263 1210	T18850 46	389 269 1310	T60251 156	475 200 0024	T09001 113
389 263 1410	T15553 46	389 269 1406	T39053 155	494 335 0075	T09035 272
389 263 1413	T12233 21	389 269 1506	T39053 155	494 335 0214	T09036 89
389 263 1531	T20289 183	389 269 1606	T53154 155	541 030 0105	T47602 118
389 263 1631	T17272 183	389 269 1706	T53154 155	542 030 0205	T47602 118
389 263 1813	T17384 21	389 269 1901	T53149 155	580616 TR1	T22631 266
389 263 1910	T53143 49	389 269 2001	T53149 155	602 350 2539	T19677 81
389 263 1931	T61934 184	389 269 2101	T56724 155	615 350 0040	T11713 84
389 263 2110	T54702 49	389 269 2201	T56724 155	615 353 0014	T11714 91
389 263 2113	T44033 22	389 269 3801	T38524 154	615 353 0051	T11715 205
389 263 2402	T53124 51	389 269 4734	T50076 163	615 353 0114	T75750 90
389 263 2502	T17380 52	389 269 8534	T39690 164	615 353 0115	T11720 101
389 263 2510	T54702 49	389 325 2152	T63423 151	615 353 0120	T11716 102
389 263 2702	T53124 51	389 350 0423	T14928 87	615 353 0151	T11715 205
389 263 2710	T53143 49	389 410 0122	T64059 178	615 353 0162	T11717 268
389 263 2713	T53146 22	389 410 0222	T64059 178	615 353 0251	T11718 205
389 263 2910	T54702 49	389 411 0146	T16991 177	615 353 0462	T11711 273
389 263 3013	T53146 22	389 411 0411	T74891 275	615 981 0186	T11719 148
389 263 3102	T17380 52	389 990 0219	T39371 193	616 350 0139	T08942 81
389 263 3402	T53124 51	389 990 2019	T39371 193	617 350 0139	T56709 81
389 264 0205	T20290 199	389 990 5060	T63425 124	617 353 0014	T12824 90
389 264 0223	T39257 247	389 994 0041	T49996 196	617 353 0020	T13668 103
389 264 0730	T20664 182	393 586 0035	T09034 83	617 353 0114	T12824 90
389 264 0830	T45151 182	(393 586 0035/M)	T15327 83	617 353 0120	T13668 103
389 265 0049	T52102 203	395 350 0040	T12322 83	620 410 0010	T64055 178
389 265 0201	T50069 118	395 353 0114	T12323 89	620 410 0022	T64059 178
389 265 0901	T50069 118	395 353 0277	T12324 271	6213/C3	T65697 35
389 265 1049	T15527 202	395 353 0320	T12325 103	629 269 0001	T53152 154
389 265 1249	T14815 202	395 353 0351	T12326 200	652 350 0054	T19656 62
389 265 1349	T15527 202	395 353 0451	T12327 278	652 350 0054/1	T81023 62
389 265 1449	T18588 202	395 353 0551	T15295 206	(652 350 0054/G)	T19657 60
389 265 2349	T12235 201	395 410 0022	T64055 178	(652 350 0054/S)	T19658 169
389 265 2449	T14815 202	395 410 0030	T16991 177	652 350 0239	T54693 74
389 265 2749	T18588 202	395 410 0622	T64055 178	652 350 0339	T15463 74
389 267 1319	T19072 56	395 411 0211	T16993 178	652 350 0739	T56709 81
389 267 1419	T19072 56	395 411 0811	T16993 178	652 353 0025	T14773 123
389 267 1519	T45486 56	395 981 0287	T18693 151	653 350 0054	T20412 62
389 267 2719	T45486 56	(395 981 0287/R)	T12328 148	(653 350 0054/G)	T20413 60
389 267 2819	T45486 56	402 200 0126	T64052 113	653 353 0014	T14938 89
389 267 2919	T19072 56	403 200 0926	T64052 113	653 353 0020	T14940 103
389 267 4219	T19072 56	404 200 0226	T64064 113	653 353 0050	T14193 38
389 269 0134	T67217 164	405 264 0389	T68093 276	653 353 0051	T14942 205





OEM no.	TAS no. Pag.	OEM no.	TAS no. Pag.	OEM no.	TAS no. Pag.
653 353 9750	T65121 180	658 350 0023	T15413 88	695 262 0002	T45640 127
654 410 0022	T64059 178	658 350 0223	T15329 93	695 262 0011	T45580 11
654 410 0222	T64059 178	658 350 0323	T15414 93	695 262 0014	T45604 25
654 411 0511	T74891 275	658 357 0701	T20034 108	695 262 0034	T45590 224
655 254 0206	T73032 40	658 357 0901	T83054 108	695 262 0035	T45593 233
655 254 0206/PIVOT	T94209 169	659 353 0014	T15301 91	695 262 0062	T45231 278
655 260 0197	T15164 176	659 353 0020	T15302 104	695 262 0112	T45584 15
655 410 0022	T64055 178	659 353 0050	T15303 37	695 262 0133	T49304 188
656 262 0013	T53132 20	659 353 0051	T15304 207	695 262 0233	T49304 188
656 262 0016	T63703 30	659 353 0151	T15304 207	695 263 0010	T45654 49
656 262 0023	T94344 246	668 350 0026	T76723 84	695 263 0016	T45649 31
656 262 0111	T94352 11	668 350 0139	T59285 73	695 350 0140	T75746 84
656 262 0116	T69315 30	668 350 0439	T59285 73	696 350 0040	T09031 83
656 262 0117	T94346 16	668 350 0739	T59285 73	696 357 0101	T57629 179
656 262 0211	T69317 10	670 330 0219	T40118 134	800574 A	T49218 32
656 262 0212	T94349 14	674 350 0339	T53556 73	805046/801464	T22617 262
656 262 0235	T94367 228	674 353 0362	T01159 269	900055 060300	T61930 195
656 262 0323	T94354 247	674 356 0226	T16989 121	904 350 0039	T19677 81
656 262 0335	T63705 234	675 262 0137	T68563 240	906 350 1523	T93886 82
656 262 0434	T63701 222	675 330 0019	T40118 134	906 350 2323	T93887 82
656 262 0435	T69735 234	675 353 0215	T71057 99	910105 012026	T94210 191
656 262 0523	T94354 247	682 353 7015	T57626 101	910105 016005	T49325 193
656 262 0705	T94348 135	682 353 7020	T57627 104	910105 020025	T50091 193
656 262 0734	T94331 215	688 350 0039	T53556 73	912004 010102	T19644 278
656 262 0735	T94350 228	688 350 0239	T53556 73	912006 010001	T75830 277
656 262 0805	T53120 137	693 262 0035	T45218 232	912009 035100	T94207 279
656 262 0823	T94354 247	693 262 0135	T45600 118	914112 012303	T11722 190
656 262 0910	T94336 24	693 262 0534	T45196 223	914112 014312	T19171 192
656 262 0917	T94346 16	693 263 0010	T45654 49	914112 014313	T19207 192
656 262 1010	T94330 45	694 262 0013	T45574 20	930 260 0124	T39792 54
656 262 1035	T94350 228	694 262 0023	T45174 251	930 260 0263	T65199 121
656 262 1123	T94344 246	694 262 0034	T54700 223	930 260 0424	T39792 54
656 262 1334	T94331 215	694 262 0035	T45600 118	930 260 0605	T58207 135
656 262 2882	T54743 130	694 262 0115	T54378 28	930 260 1824	T39792 54
656 262 3282	T53130 130	694 262 0123	T45187 253	930 260 2124	T66141 53
656 262 4413	T53132 20	694 262 0134	T45196 223	930 262 0003	T66813 133
656 262 6082	T53130 130	694 262 0135	T51970 228	930 262 0013	T65419 18
656 262 6102	T53130 130	694 262 0234	T45609 221	930 262 0033	T38832 188
656 262 7982	T94334 133	694 262 0235	T45218 232	930 262 0034	T38834 217
656 262 8082	T69290 130	694 262 0334	T45611 222	930 262 0112	T38824 14
656 262 9802	T54743 130	694 262 0335	T45183 233	930 262 0113	T65419 18
656 263 0013	T53146 22	694 263 0002	T45618 53	930 262 0117	T65948 43
656 263 0016	T63707 31	694 263 0010	T51908 50	930 262 0123	T50812 248
656 263 0410	T94360 22	694 263 0013	T45239 22	930 262 0125	T39048 171
656 263 0610	T94358 49	694 263 0015	T54380 29	930 262 0133	T38833 188
656 263 0810	T94358 49	694 263 0031	T45613 184	930 262 0145	T44023 117
656 269 0001	T53152 154	694 263 0131	T45613 184	930 262 0205	T57229 140
656 411 0012	T64065 178	694 353 0062	T75752 271	930 262 0213	T65419 18



OEM no.	TAS no. Pag.	OEM no.	TAS no. Pag.	OEM no.	TAS no. Pag.
930 262 0217	T65948 43	930 263 2610	T65989 47	942 356 0315	T84363 282
930 262 0233	T58295 186	930 264 0320	T38830 182	942 356 0715	T84363 282
930 262 0234	T38834 217	930 264 0420	T39051 181	942 981 0205	T61957 265
930 262 0305	T58207 135	930 267 0618	T57269 168	942 990 1704	T19173 192
930 262 0312	T58214 15	930 430 0087	T65037 276	943 260 0209	T73704 215
930 262 0333	T69368 185	930 438 0510	T73648 198	943 260 0509	T73714 214
930 262 0403	T38825 133	930 438 0610	T73650 198	943 260 0809	T73704 215
930 262 0413	T58210 19	942 350 0045	T15154 116	943 260 1209	T73704 215
930 262 0417	T65956 44	942 350 0064	T38926 66	943 260 1509	T73714 214
930 262 0511	T38826 10	942 350 0139	T14290 78	944 350 0243	T58398 123
930 262 0513	T65419 18	942 350 1339	T51363 80	944 350 0439	T14814 79
930 262 0517	T65956 44	942 350 1439	T51363 80	944 350 0523	T58335 66
930 262 0523	T18882 252	942 350 1539	T20618 78	944 350 0623	T85345 65
930 262 0605	T58207 135	942 350 2123	T19021 65	944 350 0623/CASE	T60943 67
930 262 0612	T38824 14	942 350 2139	T51363 80	944 350 0639	T09077 78
930 262 0613	T58210 19	(942 350 2223/CASE)	T18707 67	944 350 0739	T09077 78
930 262 0623	T18883 254	(942 350 2223/PG)	T18709 92	944 350 1839	T11045 78
930 262 0717	T65930 41	(942 350 2223/R)	T18711 69	944 350 2739	T76851 77
930 262 0723	T50812 248	(942 350 2223/SG)	T18713 101	944 350 3439	T76831 76
930 262 0805	T38827 140	(942 350 2223/SP)	T18715 102	944 350 3839	T76831 76
930 262 0811	T38826 10	(942 350 2223/W)	T18717 272	944 353 0085	T61862 71
930 262 0835	T38831 230	942 350 2239	T20618 78	944 353 0185	T61853 85
930 262 1003	T66813 133	942 350 2439	T64575 80	944 353 0225	T58398 123
930 262 1005	T94579 139	942 350 2539	T51361 79	944 353 0285	T61849 85
930 262 1205	T57313 139	942 350 2739	T20685 77	944 353 0325	T58398 123
930 262 1305	T53285 136	942 350 2839	T39261 77	944 353 0328	T60937 153
930 262 1517	T65963 44	942 350 3039	T51363 80	944 353 0385	T61859 71
930 262 1717	T38828 45	942 353 0062	T63127 272	945 260 0073	T84214 40
930 262 2105	T53285 136	942 353 0134	T53218 70	945 260 0097	T15164 176
930 262 2205	T38827 140	942 353 0135	T19079 109	945 260 0197	T93813 175
930 262 2217	T58296 41	942 353 0159	T64524 161	945 260 0261	T21059 171
930 262 2405-OLD	T57313 139	942 353 0180	T64583 119	945 260 0303	T17832 132
930 262 2417	T65963 44	942 353 0185	T59781 86	945 260 0450 MO/RING	T12209 244
930 262 3117	T65948 43	942 353 0215	T60232 72	945 260 0650 MO/RING	T11712 243
930 262 3217	T65956 44	942 353 0235	T60230 109	945 260 0850 MO	T88628 245
930 262 3617	T38829 43	942 353 0315	T20687 72	945 260 0850 MO/RING	T12204 243
930 263 0031	T57247 185	942 353 0401	T45738 67	945 260 1957	T68093 276
930 263 0110	T66000 48	942 353 0428	T45739 153	945 260 2245	T69103 245
930 263 0112/GEAR	T57277 12	942 353 0435	T18767 87	945 260 2245 MO	T84072 246
930 263 0202	T66114 52	942 353 0625	T19723 124	945 260 2245 MO/RING	T20573 244
930 263 0210	T66000 48	942 353 0645	T19725 118	945 260 3761	T21059 171
930 263 0402	T70814 52	942 353 0745	T49974 117	945 260 4461	T19491 171
930 263 0410	T65989 47	942 353 0825	T19723 124	945 260 4561	T19491 171
930 263 0510	T65989 47	942 353 0845	T49974 117	945 260 4661	T21059 171
930 263 0602	T66117 52	942 353 0925	T19723 124	945 260 7224	T62265 54
930 263 1310	T82758 16	942 353 1045	T19725 118	945 261 0080	T49905 119
930 263 1910	T57275 120	942 353 1245	T49974 117	945 261 0118	T38823 55
930 263 2510	T66000 48	942 356 0026	T14911 124	945 261 0580	T49905 119



OEM no.	TAS no. Pag.	OEM no.	TAS no. Pag.	OEM no.	TAS no. Pag.
945 261 0818	T38823 55	945 262 1617	T51534 19	945 262 4034	T15546 225
945 261 1033	T49404 54	945 262 1702	T38794 129	945 262 4082	T53156 129
945 261 1118	T38823 55	945 262 1712	T17372 14	945 262 4110	T15168 44
945 262 0006	T15165 173	945 262 1801	T38535 133	945 262 4133	T62434 186
945 262 0045	T38800 117	945 262 1802	T38794 129	945 262 4182	T76030 129
945 262 0052	T50020 208	945 262 1813	T18854 19	945 262 4202	T63273 129
945 262 0062	T39369 279	945 262 1835-OLD	T58358 234	945 262 4282	T76030 129
945 262 0108	T17255 189	945 262 1905	T17383 139	945 262 4403	T49962 132
945 262 0109	T50803 213	945 262 1913	T51534 19	945 262 4410	T39679 43
945 262 0134	T15522 219	945 262 2023	T55333 249	945 262 4433	T39046 187
945 262 0135	T15543 236	945 262 2035	T63237 231	945 262 4505	T17863 139
945 262 0137/RING	T11712 243	945 262 2123	T55350 248	945 262 4710	T38569 45
945 262 0145	T63242 116	945 262 2135	T63237 231	945 262 4717	T65963 44
945 262 0152	T50020 208	945 262 2310	T15167 26	945 262 4810	T38569 45
945 262 0162	T15159 277	945 262 2311	T63230 10	945 262 4817	T65963 44
945 262 0206	T69373 173	945 262 2510	T38569 45	945 262 4834	T61913 221
945 262 0208	T39047 189	945 262 2610	T15167 26	945 262 4934	T61910 221
945 262 0209	T50803 213	945 262 2623	T12237 253	945 262 5034	T51686 217
945 262 0210	T38569 45	945 262 2711	T63230 10	945 262 5223	T50812 248
945 262 0303	T17832 132	945 262 2723	T12310 252	945 262 5417	T20993 44
945 262 0323	T15317 252	945 262 2810	T15162 25	945 262 5434	T20990 217
945 262 0323/M	T44646 247	945 262 2823	T15317 252	945 262 5512	T58214 15
945 262 0334	T15522 219	945 262 2902	T38796 128	945 262 5534	T20991 220
945 262 0345	T49978 117	945 262 2911	T63230 10	945 262 5612	T58214 15
945 262 0412	T55325 13	945 262 3002	T38796 128	945 262 5617	T20992 26
945 262 0423	T12310 252	945 262 3017	T58296 41	945 262 5623	T51699 254
945 262 0423/M	T44647 248	945 262 3102	T38796 128	945 262 5723	T51701 253
945 262 0434	T15552 220	945 262 3111	T17375 10	945 262 5734	T68341 215
945 262 0510	T15167 26	945 262 3112	T17372 14	945 262 5912	T55325 13
945 262 0528	T20414 179	945 262 3117	T58296 41	945 262 5917	T38571 45
945 262 0534	T12284 217	945 262 3201	T38535 133	945 262 5934	T51703 221
945 262 0633	T62434 186	945 262 3202	T38796 128	945 262 6034	T51705 221
945 262 0703	T49962 132	945 262 3233	T15520 187	945 262 6112	T55325 13
945 262 0712	T17372 14	945 262 3333	T45301 187	945 262 6134	T51707 216
945 262 0762	T50090 279	945 262 3505	T17863 139	945 262 6417	T53137 20
945 262 0808	T39047 189	945 262 3513	T18854 19	945 262 6423	T19309 251
945 262 0812	T17372 14	945 262 3533	T62434 186	945 262 6523	T18882 252
945 262 0823	T12237 253	945 262 3605	T17383 139	945 262 6623	T12237 253
945 262 0909	T15411 211	945 262 3617	T58296 41	945 262 6702	T38794 129
945 262 1001	T49962 132	945 262 3634	T38536 219	945 262 6812	T58214 15
945 262 1203	T38535 133	945 262 3635	T38831 230	945 262 6823	T19309 251
945 262 1205	T55331 138	945 262 3735	T58358 234	945 262 6923	T18883 254
945 262 1234	T15526 220	945 262 3810	T15168 44	945 262 7134	T51709 222
945 262 1313	T51534 19	945 262 3834	T18880 220	945 262 7234	T54674 223
945 262 1502	T38794 129	945 262 3835	T39044 230	945 262 7502	T38796 128
945 262 1602	T38794 129	945 262 3910	T15168 44	945 262 7517	T20993 44
945 262 1610	T15168 44	945 262 3913	T18841 24	945 262 7617	T20993 44
945 262 1612	T17372 14	945 262 3935	T61825 231	945 262 7734	T38536 219



OEM no.	TAS no. Pag.	OEM no.	TAS no. Pag.	OEM no.	TAS no. Pag.
945 262 7811	T55335 134	945 265 1974	T61994 167	947 260 0545 MO/RING	T20573 244
945 262 7834	T38536 219	945 265 2774	T61994 167	947 260 0718	T66628 194
945 262 7911	T55335 134	945 265 2974	T61994 167	947 260 0736	T53250 227
945 262 8111	T55335 134	945 267 0019	T49544 56	947 260 0745	T57222 245
945 262 8211	T55335 134	945 267 0119	T49544 56	947 260 0745 MO	T70725 245
945 262 8234	T20990 217	945 267 0218	T50029 168	947 260 0836	T20995 227
945 262 8311	T55335 134	945 267 0719	T49544 56	947 260 0945	T20997 244
945 262 8810	T15167 26	945 267 0819	T49544 56	947 260 0945 MO	T88629 245
945 262 8910	T15167 26	945 267 1119	T19072 56	947 260 0945 MO/RING	T45660 244
945 262 9517	T20992 26	945 267 1319	T49125 57	947 260 1945	T57222 245
945 262 9613	T58210 19	945 267 1619	T49125 57	947 260 1945 MO	T70725 245
945 262 9713	T58210 19	945 268 0474	T39627 167	947 260 1961	T63435 171
945 262 9817	T20993 44	945 268 0746	T84214 40	947 260 2845	T69103 245
945 263 0013	T17384 21	945 268 0746/1	T84213 40	947 260 2845 MO	T84072 246
945 263 0030	T17385 170	945 268 0746/KIT	T79635 180	947 260 2845 MO/RING	T20573 244
945 263 0210	T38534 48	945 268 1210	T50100 199	947 260 2845/RING	T66552 243
945 263 0231	T63244 183	945 269 0101	T38525 155	947 260 2945	T57222 245
945 263 0302	T55344 53	945 269 0201	T38525 155	947 260 2945 MO	T70725 245
945 263 0331	T63244 183	945 269 0834	T50076 163	947 260 3036	T20995 227
945 263 0402	T55344 53	945 269 1010	T50100 199	947 260 3045	T20997 244
945 263 0431	T63244 183	945 269 1110	T50099 199	947 260 3045 MO	T88629 245
945 263 0710	T15553 46	945 981 0010	T55466 145	947 260 3045 MO/RING	T45660 244
945 263 0810	T15553 46	945 990 0019	T39371 193	947 260 3045/RING	T66545 243
945 263 0902	T17380 52	945 990 0050	T49965 151	947 260 3545	T57222 245
945 263 1110	T38534 48	945 990 0100	T51667 193	947 260 3545 MO	T70725 245
945 263 1213	T55339 20	945 990 0150	T49965 151	947 260 4036	T53260 107
945 263 1713	T17384 21	945 990 0250	T49965 151	947 260 4561	T63435 171
945 263 1813	T55339 20	945 990 0600	T51667 193	947 260 4645	T57222 245
945 263 1913	T55339 20	946 260 0097	T15164 176	947 260 6361	T53254 170
945 263 2202	T55344 53	946 260 3561	T19491 171	947 260 9361	T63435 171
945 263 2302	T55344 53	946 260 3661	T19491 171	947 262 0117	T65960 44
945 263 2902	T17380 52	946 260 4061	T38798 171	947 262 0135	T68492 234
945 263 2913	T18859 22	946 260 4161	T38798 171	947 262 0210	T65951 43
945 263 3213	T17384 21	946 262 6137	T70725 245	947 262 0305	T66947 135
945 263 5413	T66531 120	946 262 6137/RING	T70729 244	947 262 0310	T65951 43
945 263 5513	T66531 120	946 262 6337	T84072 246	947 262 0334	T56952 216
945 263 5613	T66531 120	946 262 6337/RING	T20573 244	947 262 0345	T20944 114
945 263 5713	T66533 120	946 350 0145	T82129 116	947 262 0412	T65325 14
945 263 5813	T66533 120	946 351 0072	T11231 152	947 262 0413	T65433 19
945 263 7313	T66533 120	946 353 0014	T60247 88	947 262 0423	T50815 247
945 264 0008	T81944 107	946 353 0015	T60243 97	947 262 0435	T68495 233
945 264 0009	T81950 108	946 356 0015	T54591 188	947 262 0612	T65325 14
945 264 0130	T20664 182	947 260 0097	T56957 175	947 262 0613	T65433 19
945 264 0220	T50093 181	947 260 0197	T53264 175	947 262 0634	T53256 215
945 264 0420	T50093 181	947 260 0297	T53264 175	947 262 0705	T53261 136
945 264 0520	T50092 181	947 260 0397	T41498 174	947 262 0709	T56954 214
945 264 0620	T50094 181	947 260 0545	T69103 245	947 262 0735	T68498 227
945 265 0149	T15527 202	947 260 0545 MO	T84072 246	947 262 0809	T56954 214





OEM no.	TAS no. Pag.	OEM no.	TAS no. Pag.	OEM no.	TAS no. Pag.
947 262 0812	T65335 14	947 263 0512	T40155 11	948 353 0024	T70990 268
947 262 0835	T68498 227	947 263 0513	T65479 21	948 353 0062	T70980 270
947 262 0912	T65335 14	947 263 0702	T66111 52	948 353 0101	T70978 67
947 262 1009	T68270 212	947 263 0731	T67454 183	948 353 0121	T70986 97
947 262 1012	T65335 14	947 263 0910	T66536 121	9483531212+1710	T61191 82
947 262 1108	T56959 189	947 263 1031	T67447 182	960 260 0408	T41447 47
947 262 1109	T68270 212	947 263 1131	T67447 182	960 260 3318	T66628 194
947 262 1123	T50815 247	947 263 1231	T67447 182	960 262 0009	T70807 213
947 262 1208	T56959 189	947 263 1431	T67447 182	960 262 0091	T53260 107
947 262 1209	T68270 212	947 263 1613	T66531 120	960 262 0105	T70803 140
947 262 1302	T82756 129	947 263 1713	T66531 120	960 262 0191	T53260 107
947 262 1308	T56959 189	947 263 2402	T66073 50	960 262 0433	T91947 187
947 262 1309	T68270 212	947 263 2910	T66536 121	960 262 0517	T65930 41
947 262 1311	T66884 135	947 264 0420	T53252 181	960 262 0617	T65930 41
947 262 1335	T81936 230	947 265 0149	T67907 202	960 262 0793	T14487 209
947 262 1423	T50815 247	947 265 0249	T15527 202	960 262 0934	T41469 216
947 262 1433	T67445 182	947 265 0349	T18588 202	960 262 1523	T50812 248
947 262 1435	T81936 230	947 265 0449	T58300 203	960 262 2235	T38831 230
947 262 1505	T53261 136	947 265 0649	T67907 202	960 262 3135	T38831 230
947 262 1510	T65960 44	947 265 0801	T50069 118	960 262 3805	T70803 140
947 262 1533	T67445 182	947 265 0849	T49332 202	960 263 0002	T94584 50
947 262 1605	T53261 136	947 265 2601	T50069 118	960 263 0010	T94582 120
947 262 1609	T68270 212	947 265 2701	T50069 118	960 265 0574	T61994 167
947 262 1611	T65223 9	947 269 0501	T38524 154	960 265 0774	T61994 167
947 262 1633	T67445 182	947 269 1001	T38524 154	960 267 0118	T57269 168
947 262 1705	T53261 136	947 269 1010	T50100 199	960 269 0434	T39691 164
947 262 1811	T66884 135	947 269 1110	T50099 199	967 260 0124	T66843 53
947 262 1911	T65223 9	948 262 0011	T38826 10	967 262 0114	T66794 120
947 262 1933	T67445 182	948 262 0202	T38825 133	967 265 0149	T49332 202
947 262 2012	T65335 14	948 262 0205	T70803 140	967 981 0012	T65899 141
947 262 2110	T65951 43	948 262 0209	T70807 213	970 260 0344	T55055 11
947 262 2210	T65951 43	948 262 0212	T38824 14	970 260 0754	T49331 167
947 262 2223	T50815 247	948 262 0233	T38833 188	970 260 0914	T61106 25
947 262 2412	T65335 14	948 262 0610	T65192 9	970 260 1554	T49331 167
947 262 2508	T67592 190	948 262 1010	T38828 45	970 260 1944	T94032 29
947 262 2533	T67445 182	948 262 1210	T38829 43	970 260 2054	T41444 167
947 262 2635	T81936 230	948 262 2210	T65930 41	970 260 2244	T61097 15
947 262 2745	T20944 114	948 262 2310	T65930 41	970 260 2344	T61106 25
947 262 2912	T65325 14	948 263 0231	T57247 185	970 260 2544	T61097 15
947 262 3510	T65933 41	948 350 0023	T71055 66	970 260 2844	T45595 237
947 262 4202	T82756 129	948 350 0023R	T91097 66	970 260 2944	T45597 237
947 262 5110	T65192 9	948 350 0103	T75766 125	970 260 3644	T55055 11
947 262 5210	T65951 43	948 350 0123R	T91098 84	970 260 5031	T69160 118
947 262 5310	T65192 9	948 350 0223	T91098 84	970 261 0233	T45215 54
947 263 0111	T65271 11	948 353 0001	T70978 67	970 261 0333	T45215 54
947 263 0112	T40155 11	948 353 0014	T70988 92	970 261 0633	T45215 54
947 263 0212	T40155 11	948 353 0015	T70982 98	970 262 0105	T61109 138
947 263 0413	T65479 21	948 353 0021	T70984 88	970 262 0134	T45170 239



OEM no.	TAS no. Pag.	OEM no.	TAS no. Pag.	OEM no.	TAS no. Pag.
970 262 0194	T49302 111	970 262 2152	T69163 282	970 993 1801	T45210 209
970 262 0205	T51905 139	970 262 2252	T69162 282	970 993 3501	T45210 209
970 262 0237	T45178 240	970 262 2334	T45611 222	970 993 4601	T45210 209
970 262 0274	T45168 177	970 262 2434	T19033 226	970 993 6401	T45210 209
970 262 0294	T49301 111	970 262 2435	T45218 232	970 994 1141	T49298 180
970 262 0311	T45580 11	970 262 2534	T19035 226	970 994 1941	T49269 203
970 262 0362	T49324 279	970 262 2535	T45183 233	970 994 3541	T60798 196
970 262 0394	T49300 111	970 262 2834	T45170 239	971 262 0323	T75567 248
970 262 0405	T51905 139	970 262 2923	T45200 251	971 262 0562	T19033 226
970 262 0433	T49304 188	970 262 2934	T45181 239	971 262 0635	T75565 229
970 262 0494	T49299 111	970 262 2944	T45187 253	971 262 1323	T75567 248
970 262 0502	T61112 128	970 262 3023	T45187 253	971 262 1562	T19035 226
970 262 0505	T66801 135	970 262 3034	T45170 239	972 262 0089	T51796 240
970 262 0511	T45580 11	970 262 3034 CB	T75470 242	972 262 0089 CB	T75553 242
970 262 0533	T49304 188	970 262 3037	T45192 242	972 262 0135	T75565 229
970 262 0602	T61112 128	970 262 3134	T45181 239	972 262 0189	T51796 240
970 262 0835	T45600 118	970 262 3134 CB	T75458 243	972 262 0289	T51796 240
970 262 1005	T51905 139	970 262 3237	T19039 242	972 262 0523	T75567 248
970 262 1012	T45584 15	970 262 3323	T45174 251	972 262 0735	T75582 229
970 262 1113	T45574 20	970 262 3423	T45187 253	972 262 2023	T45200 251
970 262 1114	T45604 25	970 262 3437	T45178 240	973 262 0134	T19033 226
970 262 1152	T49292 280	970 262 3537	T19036 240	973 262 0335	T75582 229
970 262 1213	T45574 20	970 262 3723	T45174 251	974 262 0034	T19035 226
970 262 1214	T45604 25	970 262 3837	T19038 242	974 262 0035	T45183 233
970 262 1234	T45181 239	970 262 3937	T19039 242	974 262 1302	T82756 129
970 262 1235	T51901 235	970 262 5937	T19039 242	975 262 0005	T45646 137
970 262 1252	T49291 280	970 262 6037	T19038 242	975 262 0023	T45187 253
970 262 1312	T45584 15	970 263 0016	T45649 31	975 262 0034	T45590 224
970 262 1352	T49290 280	970 263 0031	T45613 184	975 262 0102	T45640 127
970 262 1437	T45192 242	970 263 0093	T49268 203	975 262 0111	T45580 11
970 262 1452	T49289 280	970 263 0231	T45613 184	975 262 0112	T45584 15
970 262 1514	T66794 120	970 263 0302	T69151 53	975 262 0113	T45574 20
970 262 1534	T45196 223	970 263 0331	T45613 184	975 262 0114	T45604 25
970 262 1535	T51901 235	970 263 0402	T69151 53	975 262 0123	T45200 251
970 262 1537	T45192 242	970 263 0410	T51908 50	975 262 0133	T49304 188
970 262 1552	T49288 281	970 263 0510	T51908 50	975 262 0134	T45196 223
970 262 1612	T45584 15	970 263 0515	T54380 29	975 262 0135	T45600 118
970 262 1652	T49287 281	970 263 0602	T69151 53	975 262 0223	T45174 251
970 262 1734	T45609 221	970 263 0610	T51908 50	975 262 0234	T45611 222
970 262 1752	T49286 281	970 263 0613	T45239 22	975 262 0334	T45609 221
970 262 1852	T49285 281	970 263 0615	T54380 29	975 263 0102	T45618 53
970 262 1902	T45232 131	970 263 0702	T45618 53	975 263 0110	T45654 49
970 262 1937	T19036 240	970 263 0713	T45239 22	975 263 0113	T45239 22
970 262 1952	T49284 281	970 263 0802	T45618 53	975 263 0116	T45649 31
970 262 2002	T45232 131	970 265 0449	T69145 201	976 262 0015	T51119 28
970 262 2023	T45200 251	970 350 0240	T76992 83	976 262 0045	T20944 114
970 262 2052	T49283 282	970 353 0025	T63438 124	976 262 0062	T49296 279
970 262 2123	T45200 251	970 981 0081	T45623 38	976 262 0113	T19666 20



OEM no.	TAS no. Pag.	OEM no.	TAS no. Pag.	OEM no.	TAS no. Pag.
976 262 0116	T45627 29	976 262 1802	T45236 127	T38645	T38645 214
976 262 0145	T20944 114	976 262 2005	T19669 137	TAS14256	T14256 69
976 262 0202	T45625 127	976 262 2105	T19669 137	TAS20182/S	T91058 106
976 262 0210	T20909 42	976 262 2210	T20909 42	TAS40155	T40155 11
976 262 0214	T44042 25	976 262 2302	T49282 127	TAS40156	T40156 198
976 262 0216	T45627 29	976 262 2401	T17833 133	TAS41496	T41496 172
976 262 0345	T20944 114	976 262 2402	T49282 127	TAS41504	T41504 82
976 262 0462	T45231 278	976 262 2501	T17833 133	TAS45740	T45740 105
976 262 0502	T45625 127	976 262 2834	T19671 223	TAS45741	T45741 97
976 262 0516	T45627 29	976 262 2905	T45646 137	TAS45744	T45744 88
976 262 0534	T19671 223	976 262 3034	T75667 241	TAS49097	T49097 105
976 262 0694	T49293 112	976 262 3105	T40496 136	TAS49098	T49098 106
976 262 0705	T45638 137	976 262 3234	T75667 241	TAS51377	T51377 60
976 262 0713	T19666 20	976 262 3434	T66797 216	TAS51379	T19658 169
976 262 0814	T44042 25	976 262 4402	T40495 125	TAS52215	T73879 23
976 262 0816	T45627 29	976 263 0016	T45649 31	TAS52216	T73880 23
976 262 0835	T45633 233	976 263 0030	T17385 170	TAS53265	T53265 172
976 262 0894	T49295 112	976 263 0215	T65633 29	TAS56971	T56971 172
976 262 0913	T19666 20	976 263 0216	T45649 31	TAS60607	T73880 23
976 262 0914	T66794 120	976 263 0615	T65633 29	TAS60893	T60893 106
976 262 0915	T51119 28	976 263 0710	T22070 31	TAS60943	T60943 67
976 262 0916	T45627 29	976 263 0810	T19673 49	TAS61089	T61089 94
976 262 0935	T45633 233	976 263 1110	T45654 49	TAS61090	T61090 37
976 262 1013	T19666 20	976 263 1210	T45654 49	TAS61191	T61191 82
976 262 1016	T40499 30	976 265 0049	T49332 202	TAS61195	T61195 74
976 262 1094	T49293 112	976 269 0034	T39691 164	TAS61827	T61827 119
976 262 1105	T19669 137	976 981 0012	T45205 141	TAS63124	T63124 94
976 262 1113	T19666 20	976 990 0050	T67131 151	TAS63506	T63506 119
976 262 1194	T49294 112	976 990 0150	T67131 151	TAS63507	T63507 163
976 262 1205	T45638 137	EC43994S01	T52217 257	TAS63508	T63508 153
976 262 1294	T49295 112	ETA-C1R-1104	T37781 261	TAS63509	T63509 153
976 262 1305	T19669 137	F 224451.04	T45205 141	TAS63510	T63510 163
976 262 1402	T45640 127	F-207054	T46630 142	TAS64066	T64066 112
976 262 1405	T45646 137	F-219518	T46608 148	TAS64970	T64970 94
976 262 1411	T45580 11	F-221001	T47537 34	TAS64974	T08973 99
976 262 1502	T45640 127	F-224448.K-HLA	T45570 141	TAS65159	T65159 179
976 262 1505	T19669 137	F-225955	T49227 142	TAS65571	T65571 174
976 262 1510	T19667 30	F-563007.RTR1	T61826 263	TAS66844	T66844 140
976 262 1512	T59106 15	F-57368.01	T46634 145	TAS66847	T66847 119
976 262 1515	T51119 28	F-805045	T47545 33	TAS67079	T67079 238
976 262 1594	T69141 111	F-95451.02	T46615 147	TAS67081	T67081 237
976 262 1612	T59106 15	JXC25690 C/JXC25690 DC	T52390 259	TAS67824	T67824 41
976 262 1615	T51119 28	K55X60X20	T51998 143	TAS69431	T69431 239
976 262 1634	T45644 222	(MB-346)	T20182 106	TAS69742	T69742 31
976 262 1702	T45236 127	(MB-355)	T20189 106	TAS70124	T70124 172
976 262 1705	T45646 137	NP 057427	T38391 259	TAS70478	T70478 153
976 262 1734	T45644 222	SET 1041	T39606 261	TAS70982	T70982 98
976 262 1794	T69142 110	SET 1110	T22624 260	TAS70988	T70988 92



<b>OEM no.</b>	<b>TAS no. Pag.</b>	<b>OEM no.</b>	<b>TAS no. Pag.</b>	<b>OEM no.</b>	<b>TAS no. Pag.</b>
TAS73982	T73982 97				
TAS74627	T74627 94				
TAS74803	T74803 39				
TAS75817	T75817 68				
TAS75818	T75818 68				
TAS75819	T75822 114				
TAS75820	T75820 68				
TAS75821	T75821 68				
TAS76220	T76220 94				
TAS77792	T15759 149				
TAS78237	T78237 275				
TAS80902	T80902 197				
TAS81510	T81510 40				
TAS82728	T82728 180				
TAS82730	T82730 238				
TAS83439	T83439 85				
TAS86080	T86080 95				
TAS91093	T91093 97				
TAS91095	T91095 96				
TAS93518	T93518 74				
TAS93522	T93522 237				
TAS93523	T93523 238				
TAS93524	T93524 238				
TAS93525	T93525 238				
TAS93819	T93819 210				
TAS93880	T93880 105				
TAS93900	T93900 239				
TAS93901	T93901 239				
TAS94033	T94033 107				
TAS94237	T94237 41				
VKHB 2060	T39606 261				





TAS no.	OEM no.	Pag.	TAS no.	OEM no.	Pag.	TAS no.	OEM no.	Pag.
T00093	309 350 1439	73	T07565	322 263 0114	28	T08196	322 262 4050	39
T00093	309 350 1139	73	T07569	337 263 0814	27	T08198	322 263 0302	50
T00093	309 350 0839	73	T07569	337 263 0314	27	T08198	322 263 0202	50
T00093	309 350 0239	73	T07571	340 262 0502	126	T08198	321 263 0502	50
T01143	302 353 0014	89	T07571	340 262 0402	126	T08201	322 263 0433	186
T01144	302 353 0015	100	T07571	340 262 0202	126	T08201	322 263 0333	186
T01147	352 353 0024	270	T07574	340 263 0110	47	T08203	322 263 0513	16
T01147	312 353 1224	270	T07574	340 263 0010	47	T08203	322 263 0313	16
T01149	321 262 1123	250	T07947	322 262 0635	229	T08203	322 263 0013	16
T01149	321 262 0723	250	T07947	322 262 0435	229	T08205	322 263 0610	48
T01151	321 262 1223	250	T07949	322 262 0735	229	T08205	322 263 0010	48
T01151	321 262 0823	250	T07949	322 260 1835	229	T08278	302 262 0312	13
T01153	322 260 0825	184	T07949	321 262 1835	229	T08280	302 262 0535	233
T01153	322 260 0725	184	T08021	327 353 2162	201	T08281	302 262 1502	127
T01153	322 260 0325	184	T08022	327 353 2462	200	T08284	307 263 0110	47
T01154	322 260 2044	23	T08023	327 353 4962	273	T08285	307 263 0513	15
T01154	322 260 1744	23	T08023	327 353 3962	273	T08285	307 263 0413	15
T01155	322 262 0802	125	T08023	327 353 3262	273	T08287	314 260 0725	185
T01155	322 262 0102	125	T08023	327 353 0062	273	T08287	314 260 0425	185
T01157	322 262 0137	241	T08025	327 353 4762	271	T08289	314 260 2444	23
T01158	322 262 0705	136	T08025	327 353 4662	271	T08293	314 260 3644	17
T01158	322 262 0505	136	T08025	327 353 0162	271	T08299	314 262 0802	126
T01158	322 262 0005	136	T08028	354 350 0823	64	T08299	314 262 0402	126
T01159	674 353 0362	269	T08028	354 350 0123	64	T08301	314 262 0902	126
T01159	322 353 0162	269	T08028	350 350 0223	64	T08301	314 262 0502	126
T01160	327 460 2208	210	T08028	345 350 1323	64	T08301	314 262 0302	126
T01161	327 460 2308	210	T08028	302 350 2023	64	T08301	314 262 0202	126
T01162	337 260 1625	184	T08029	354 353 0086	59	T08301	308 262 7002	126
T01162	337 260 1425	184	T08029	327 353 0586	59	T08305	314 262 1223	249
T01162	337 260 0525	184	T08030	354 353 0174	169	T08305	314 262 1123	249
T01164	354 353 0014	90	T08030	354 353 0074	169	T08306	314 262 1434	217
T01165	354 353 0015	100	T08176	321 262 0674	177	T08306	314 262 0734	217
T01166	358 353 0015	100	T08177	321 262 0774	177	T08308	314 262 1534	218
T01166	322 353 0615	100	T08178	321 262 0940	200	T08308	314 262 0834	218
T01167	360 353 0020	104	T08179	321 262 1040	200	T08310	314 263 0710	48
T01170	383 353 0120	103	T08182	321 993 0701	210	T08310	314 263 0610	48
T01170	345 353 7120	103	T08185	322 260 2444	16	T08310	314 263 0210	48
T01170	345 353 7020	103	T08185	322 260 1944	16	T08313	314 263 1002	51
T01170	322 353 0120	103	T08188	322 262 0412	13	T08316	314 263 1414	28
T05823	322 353 0715	100	T08188	322 262 0112	13	T08316	314 263 1214	28
T05823	322 353 0115	100	T08188	321 262 0212	13	T08316	314 263 0614	28
T05823	322 353 0015	100	T08190	322 262 0434	218	T08316	314 263 0514	28
T05823	321 353 0115	100	T08190	322 262 0034	218	T08320	337 260 3044	23
T05826	(312 350 1739/PINION)	70	T08192	322 262 0511	9	T08320	337 260 2744	23
T07561	322 262 0237	241	T08192	322 262 0211	9	T08322	337 260 3144	24
T07565	322 263 0614	28	T08194	322 262 5650	39	T08322	307 260 4244	24
T07565	322 263 0514	28	T08194	322 262 1150	39	T08322	307 260 3544	24
T07565	322 263 0314	28	T08196	322 262 6550	39	T08322	307 260 1644	24



TAS no.	OEM no.	Pag.	TAS no.	OEM no.	Pag.	TAS no.	OEM no.	Pag.
T08323	337 262 0223	249	T08954	343 350 0039	82	T09007	355 350 3239	75
T08323	337 262 0023	249	T08957	346 350 0128	105	T09007	305 350 0539	75
T08325	337 262 0505	136	T08962	(346 350 0654/S)	168	T09009	355 350 4739	76
T08327	337 262 0635	232	T08963	346 350 1939	77	T09011	355 353 0026	121
T08327	337 262 0035	232	T08963	346 350 4139	77	T09012	355 353 0176	270
T08328	337 262 0713	17	T08965	346 350 8039	79	T09013	355 353 0214	89
T08328	337 262 0313	17	T08965	346 350 3739	79	T09013	355 353 0014	89
T08330	337 262 0735	232	T08965	346 350 3539	79	T09015	355 353 0215	98
T08330	337 262 0335	232	T08969	346 353 0085	72	T09015	355 350 0126	98
T08331	337 262 1234	218	T08970	346 353 0124	267	T09017	355 353 0950	38
T08331	337 262 1034	218	T08971	346 353 0126	122	T09017	355 353 0250	38
T08333	337 263 0702	50	T08972	346 353 0224	268	T09019	355 353 0315	99
T08333	337 263 0602	50	T08973	346 353 0815	99	T09020	355 353 0562	269
T08335	337 263 0713	16	T08973	346 353 0315	99	T09021	355 353 0620	102
T08335	337 263 0513	16	T08973	TAS64974	99	T09024	355 353 0750	37
T08337	337 263 0810	47	T08976	346 353 1762	274	T09027	355 353 6051	206
T08337	337 263 0610	47	T08976	346 353 0362	274	T09028	355 354 0162	204
T08341	381 262 0023	250	T08979	346 353 0420	103	T09031	387 350 0040	83
T08341	307 262 0023	250	T08981	346 353 0514	91	T09031	387 586 0035	83
T08342	381 262 0135	232	T08981	346 353 0114	91	T09031	696 350 0040	83
T08343	383 262 0023	250	T08984	346 353 0562	269	T09031	386 350 0040	83
T08344	383 262 0033	186	T08985	346 353 1014	91	T09033	000 981 7987	149
T08345	383 262 0134	219	T08985	346 353 0614	91	T09034	393 586 0035	83
T08346	383 262 0235	232	T08985	346 353 1914	91	T09035	494 335 0075	272
T08347	383 263 0202	51	T08987	346 353 1136	102	T09036	494 335 0214	89
T08534	302 260 1644	18	T08987	346 353 0836	102	T09075	355 350 0227	69
T08537	302 263 0410	48	T08987	346 353 0736	102	T09077	944 350 0739	78
T08540	307 263 0614	27	T08989	346 353 2562	274	T09077	944 350 0639	78
T08568	340 262 0134	218	T08989	346 353 0862	274	T09077	355 350 4139	78
T08568	340 262 0034	218	T08990	346 353 0950	36	T09077	355 350 3639	78
T08595	381 262 0037	241	T08991	346 353 3251	204	T09144	308 353 0020	104
T08595	302 262 0537	241	T08991	346 353 2551	204	T09160	355 353 1862	274
T08597	381 262 0102	126	T08992	346 354 0412	95	T09160	355 353 0462	274
T08601	383 262 0802	126	T08993	346 354 0417	211	T09187	346 350 1739	76
T08603	383 263 0031	183	T08995	346 354 1109	63	T09187	346 350 4039	76
T08822	000 077 0425	176	T08996	346 586 0135	61	T09189	355 350 3939	75
T08822	000 077 0325	176	T08998	(346 586 0135/G)	59	T09189	355 350 3839	75
T08826	(000 260 0397/G)	174	T08999	355 030 2703	112	T09241	346 354 0909	63
T08832	(000 260 1197/G)	174	T08999	355 030 2203	112	T09507	355 353 2262	273
T08942	616 350 0139	81	T09000	355 132 0215	32	T09507	355 353 1062	273
T08942	383 350 0039	81	T09001	475 200 0024	113	T09507	355 353 0362	273
T08942	364 350 0239	81	T09001	355 200 1124	113	T09509	355 353 2362	273
T08942	341 350 0739	81	T09001	345 200 7724	113	T09509	355 353 1162	273
T08942	322 350 1839	81	T09004	355 350 0128	105	T09526	357 350 0039	75
T08944	315 354 0610	70	T09006	355 350 4039	76	T09526	346 350 5739	75
T08944	315 354 0510	70	T09006	355 350 3739	76	T09526	346 350 5639	75
T08945	326 354 1112	72	T09007	357 350 0539	75	T09526	346 350 3939	75
T08945	326 354 0612	72	T09007	355 350 4639	75	T09526	346 350 1639	75



TAS no.	OEM no.	Pag.	TAS no.	OEM no.	Pag.	TAS no.	OEM no.	Pag.
T09672	346 350 6239	73	T11790	389 262 0209	212	T12231	389 262 2710	42
T09672	346 350 4239	73	T11848	346 350 0545	116	T12232	389 262 9134	226
T09672	346 350 1839	73	T11865	346 350 9928	92	T12233	389 263 1413	21
T09673	346 350 3039	73	T11991	355 353 0225	123	T12234	389 263 1110	46
T09674	346 354 0517	211	T11992	380 353 0014	90	T12235	389 265 2349	201
T09795	346 350 0554	61	T12201	387 262 1523	251	T12237	945 262 6623	253
T09797	(346 586 0035/G)	59	T12201	387 262 0523	251	T12237	945 262 0823	253
T11045	944 350 1839	78	T12201	387 262 0223	251	T12237	945 262 2623	253
T11045	355 350 5139	78	T12204	389 262 0537/RING	243	T12281	389 262 0035	235
T11045	355 350 3039	78	T12204	389 262 0137/RING	243	T12281	387 262 1735	235
T11045	305 350 0639	78	T12204	389 262 0037/RING	243	T12282	389 262 0312	12
T11113	346 354 1362	268	T12204	945 260 0850 MO/RING	243	T12282	389 262 0012	12
T11113	355 354 0462	268	T12205	389 262 1312	12	T12283	389 262 3901	131
T11132	371 353 0025	122	T12205	389 262 1212	12	T12284	945 262 0534	217
T11132	355 353 0125	122	T12206	389 262 1413	18	T12284	389 262 5034	217
T11133	355 353 0325	122	T12206	389 262 1313	18	T12300	389 260 0297	175
T11134	385 260 0390	154	T12206	389 262 0913	18	T12303	001 981 2787	150
T11135	389 260 0690	154	T12206	389 262 0813	18	T12306	389 262 0806	254
T11135	389 260 0590	154	T12207	389 262 1505	137	T12308	389 262 2210	42
T11135	389 260 0490	154	T12207	389 262 1205	137	T12310	945 262 2723	252
T11227	355 354 1312	95	T12208	389 262 1723	249	T12310	945 262 0423	252
T11227	346 354 0512	95	T12208	389 262 0023	249	T12310	389 262 1223	252
T11229	355 354 1809	62	T12209	389 262 0637/RING	244	T12310	389 262 2623	252
T11229	355 354 0709	62	T12209	389 262 1337/RING	244	T12311	346 350 0427	67
T11231	946 351 0072	152	T12209	389 262 2537/RING	244	T12312	346 350 2639	76
T11231	385 351 0572	152	T12209	945 260 0450 MO/RING	244	T12312	346 350 2139	76
T11231	346 353 0072	152	T12217	389 262 2901	131	T12314	346 350 8123	65
T11445	001 981 2287	150	T12218	389 262 2923	252	T12316	355 353 0085	71
T11446	355 353 1050	38	T12218	389 262 0723	252	T12317	355 353 0615	98
T11446	355 353 0150	38	T12220	389 262 3023	251	T12318	387 350 1323	65
T11711	615 353 0462	273	T12220	389 262 2223	251	T12318	355 350 7623	65
T11711	385 353 4062	273	T12220	389 262 0623	251	T12320	387 350 5923	65
T11711	385 353 3062	273	T12221	389 262 0223	248	T12320	387 350 1523	65
T11711	385 353 2362	273	T12222	389 262 3710	26	T12322	395 350 0040	83
T11712	389 262 0737/RING	243	T12222	389 262 1710	26	T12323	395 353 0114	89
T11712	945 262 0137/RING	243	T12222	389 262 1610	26	T12324	395 353 0277	271
T11712	387 262 1137/RING	243	T12224	389 262 4935	236	T12325	395 353 0320	103
T11712	945 260 0650 MO/RING	243	T12224	389 262 2035	236	T12326	395 353 0351	200
T11713	615 350 0040	84	T12226	389 262 5510	27	T12327	395 353 0451	278
T11714	615 353 0014	91	T12226	389 262 2310	27	T12328	(395 981 0287/R)	148
T11715	615 353 0051	205	T12227	389 262 5610	26	T12339	389 260 8961	170
T11715	615 353 0151	205	T12227	389 262 4410	26	T12340	389 262 0135	230
T11716	615 353 0120	102	T12228	389 262 5634	224	T12341	389 262 0208	189
T11717	615 353 0162	268	T12228	389 262 3934	224	T12342	389 262 1535	235
T11718	615 353 0251	205	T12228	389 262 2434	224	T12469	322 262 0045	114
T11719	615 981 0186	148	T12228	389 262 1534	224	T12824	617 353 0114	90
T11720	615 353 0115	101	T12228	389 262 1234	224	T12824	617 353 0014	90
T11722	914112 012303	190	T12231	389 262 7710	42	T13517	389 262 1110	27



TAS no.	OEM no.	Pag.	TAS no.	OEM no.	Pag.	TAS no.	OEM no.	Pag.
T13517	389 262 0210	27	T14911	942 356 0026	124	T15168	945 262 4110	44
T13668	617 353 0120	103	T14911	355 356 0126	124	T15168	945 262 1610	44
T13668	617 353 0020	103	T14928	387 350 9823	87	T15168	945 262 3810	44
T14193	653 353 0050	38	T14928	389 350 0423	87	T15168	945 262 3910	44
T14256	TAS14256	69	T14930	355 350 1415	85	T15169	000914 006109	267
T14256	(387 350 5923/CASE)	69	T14931	355 353 0126	124	T15266	381 981 0087	151
T14290	942 350 0139	78	T14933	355 353 0935	87	T15266	000 981 8387	151
T14290	346 350 2939	78	T14933	355 353 0235	87	T15266	000 981 8487	151
T14290	346 350 2439	78	T14935	355 353 1236	101	T15267	(381 981 0087/R)	149
T14424	387 981 0187	150	T14935	355 353 1036	101	T15268	385 260 3245	219
T14449	346 353 0925	122	T14935	355 353 0736	101	T15268	385 260 1345	219
T14457	385 350 0040	84	T14936	355 353 1115	98	T15270	385 262 0109	213
T14458	385 350 3639	81	T14937	355 350 1827	69	T15271	385 262 0152	204
T14460	385 353 1262	271	T14937	355 350 0327	69	T15272	385 262 0923	250
T14487	387 262 0893	209	T14938	653 353 0014	89	T15273	385 262 1152	278
T14487	387 262 0793	209	T14940	653 353 0020	103	T15273	004 262 0062	278
T14487	960 262 0793	209	T14942	653 353 0051	205	T15274	385 262 1437	241
T14489	387 262 1093	208	T14980	346 353 2462	273	T15274	385 262 0637	241
T14489	387 262 0993	208	T14980	346 353 0762	273	T15276	385 262 1534	218
T14489	387 262 0693	208	T15153	000 981 4186	150	T15277	357 990 0079	267
T14492	389 260 2036	227	T15153	000 981 4386	150	T15277	385 990 0179	267
T14493	389 262 0293	209	T15154	942 350 0045	116	T15278	440 260 0097	173
T14494	389 262 0445	116	T15154	346 350 1445	116	T15278	385 262 0407	173
T14495	389 262 0635	235	T15155	389 260 0497	176	T15279	(440 260 0097/G)	172
T14496	389 262 4034	226	T15156	(389 260 0497/G)	173	T15280	(440 260 0097/SHAFT)	169
T14500	346 350 8139	79	T15157	389 262 0162	204	T15295	395 353 0551	206
T14500	346 350 3639	79	T15157	389 262 6462	204	T15296	343 350 1023	87
T14502	346 353 0435	109	T15157	389 262 0562	204	T15296	343 350 0723	87
T14764	346 350 0443	123	T15158	389 262 0262	277	T15296	346 350 9523	87
T14766	346 350 0445	115	T15159	389 262 1162	277	T15297	346 353 0326	122
T14768	346 353 0450	39	T15159	945 262 0162	277	T15298	346 353 0735	87
T14770	346 353 0650	38	T15159	389 262 1462	277	T15298	346 353 0335	87
T14770	346 353 1050	38	T15159	389 262 1362	277	T15299	346 353 1115	100
T14773	652 353 0025	123	T15160	389 262 2810	42	T15299	346 353 0515	100
T14773	346 353 0625	123	T15161	389 262 3810	25	T15300	346 353 1785	86
T14813	346 353 0825	121	T15162	389 262 7910	25	T15300	346 353 1585	86
T14814	944 350 0439	79	T15162	945 262 2810	25	T15300	346 353 0385	86
T14814	357 350 0639	79	T15163	389 262 8610	27	T15300	346 353 0185	86
T14814	355 350 5239	79	T15164	946 260 0097	176	T15300	346 350 1324	86
T14814	355 350 2939	79	T15164	655 260 0197	176	T15301	659 353 0014	91
T14814	305 350 0339	79	T15164	945 260 0097	176	T15302	659 353 0020	104
T14815	389 265 2449	202	T15165	945 262 0006	173	T15303	659 353 0050	37
T14815	389 265 1249	202	T15166	389 262 0407	168	T15304	659 353 0051	207
T14815	387 265 0049	202	T15167	945 262 8810	26	T15304	659 353 0151	207
T14903	355 350 0745	115	T15167	945 262 0510	26	T15307	346 350 2327	69
T14905	355 350 4839	79	T15167	945 262 2610	26	T15307	346 350 0527	69
T14907	355 353 0135	108	T15167	945 262 2310	26	T15316	389 263 0062	268
T14909	355 353 0234	70	T15167	945 262 8910	26	T15317	945 262 0323	252





TAS no.	OEM no.	Pag.	TAS no.	OEM no.	Pag.	TAS no.	OEM no.	Pag.
T15317	945 262 2823	252	T15511	337 283 5006	199	T15550	389 263 0913	21
T15317	389 262 1323	252	T15512	343 353 0335	86	T15552	945 262 0434	220
T15317	389 262 2723	252	T15513	385 260 1444	13	T15552	389 262 0034	220
T15317	389 262 4123	252	T15514	385 260 1544	17	T15553	945 263 0810	46
T15327	(393 586 0035/M)	83	T15515	385 260 3061	170	T15553	945 263 0710	46
T15329	658 350 0223	93	T15515	385 260 1761	170	T15553	389 263 1410	46
T15329	355 350 0040	93	T15515	385 260 0861	170	T15580	385 262 0434	219
T15372	346 336 0062	270	T15516	385 262 2602	128	T15581	425 262 0137	240
T15373	346 350 4839	77	T15517	387 267 0650	36	T15581	385 262 1537	240
T15373	346 350 2739	77	T15517	387 267 0250	36	T15581	385 262 0137	240
T15373	346 350 2239	77	T15518	389 262 1813	19	T15618	385 262 2502	128
T15375	070852 055000	123	T15519	389 262 1854	208	T15651	346 350 0645	115
T15407	355 350 0624	85	T15520	945 262 3233	187	T15652	355 350 4939	80
T15407	355 350 0324	85	T15520	389 262 2033	187	T15654	387 262 0623	252
T15408	385 262 1035	229	T15521	389 262 4735	236	T15655	389 262 0534	225
T15409	387 350 9423	88	T15521	389 262 4635	236	T15759	TAS77792	149
T15410	389 262 0409	212	T15522	945 262 0334	219	T15759	(001 981 2287/R)	149
T15411	945 262 0909	211	T15522	945 262 0134	219	T15768	355 350 0354	61
T15411	389 262 0909	211	T15522	389 262 5434	219	T15769	(355 350 0354/G)	60
T15411	389 262 0809	211	T15525	389 262 6501	131	T15770	(355 350 0354/S)	169
T15413	658 350 0023	88	T15525	389 262 5101	131	T15784	343 350 0923	93
T15414	658 350 0323	93	T15526	389 262 9234	220	T16624	346 350 7639	78
T15463	652 350 0339	74	T15526	945 262 1234	220	T16624	346 350 4439	78
T15463	301 350 2439	74	T15527	947 265 0249	202	T16711	(000 260 1497/G)	174
T15465	385 351 0172	152	T15527	945 265 0149	202	T16893	001 981 3287	150
T15465	385 351 0072	152	T15527	389 265 1349	202	T16893	001 981 3187	150
T15465	327 353 0172	152	T15527	389 265 1049	202	T16893	001 981 3087	150
T15467	387 262 4534	224	T15533	355 350 0645	115	T16894	387 262 1813	12
T15467	387 262 4134	224	T15534	389 260 5719	24	T16895	387 262 3234	225
T15467	387 262 4131	224	T15534	389 262 2013	24	T16896	387 262 3634	225
T15467	387 262 2734	224	T15535	389 262 0062	277	T16896	387 262 3534	225
T15470	387 262 4834	224	T15536	389 262 0313	18	T16898	387 262 3814	24
T15471	387 262 5034	225	T15536	389 262 0013	18	T16898	387 262 2114	24
T15471	387 262 0734	225	T15538	389 262 0333	185	T16900	389 260 0397	175
T15473	387 262 5134	224	T15538	389 262 0033	185	T16901	(389 260 0397/SHAFT)	168
T15473	387 262 3134	224	T15539	389 262 1611	9	T16902	389 262 0606	173
T15505	315 353 0045	114	T15539	389 262 1511	9	T16903	389 262 0309	212
T15506	320 357 0053	54	T15541	389 262 1823	249	T16904	389 262 0713	18
T15507	326 354 1012	71	T15541	389 262 0923	249	T16905	389 262 1112	12
T15507	326 354 0512	71	T15542	389 262 2113	17	T16906	389 262 5410	26
T15508	326 354 1410	70	T15543	389 262 2535	236	T16906	389 262 1510	26
T15508	326 354 0910	70	T15543	945 262 0135	236	T16908	389 263 0610	46
T15509	335 357 0102	109	T15544	389 262 2910	43	T16979	337 283 5150	35
T15509	335 357 0101	109	T15546	945 262 4034	225	T16984	343 281 1314	55
T15509	335 357 0002	109	T15547	389 262 3701	131	T16986	343 352 0016	113
T15509	335 357 0001	109	T15548	389 262 6601	132	T16987	346 354 3009	63
T15510	343 282 0545	114	T15549	389 263 0802	51	T16989	674 356 0226	121
T15511	343 283 1306	199	T15550	389 263 1013	21	T16989	070852 060000	121



TAS no.	OEM no.	Pag.	TAS no.	OEM no.	Pag.	TAS no.	OEM no.	Pag.
T16991	395 410 0030	177	T17385	945 263 0030	170	T18588	947 265 0349	202
T16991	389 411 0146	177	T17545	357 350 1639	80	T18588	389 265 2749	202
T16993	395 411 0811	178	T17545	357 350 0739	80	T18588	389 265 1449	202
T16993	395 411 0211	178	T17545	357 350 0139	80	T18693	395 981 0287	151
T16993	363 411 0111	178	T17545	305 350 1639	80	T18701	000 350 8123	93
T17255	945 262 0108	189	T17545	305 350 0139	80	T18703	002 353 9177	271
T17255	389 262 0808	189	T17548	389 269 1210	199	T18705	000 353 1550	36
T17261	389 260 0661	170	T17548	389 269 0210	199	T18705	000 353 1450	36
T17262	389 260 0936	227	T17548	389 269 0310	199	T18707	(942 350 2223/CASE)	67
T17263	389 262 0040	231	T17598	389 262 0411	9	T18709	(942 350 2223/PG)	92
T17264	389 262 0435	231	T17600	389 262 1523	253	T18711	(942 350 2223/R)	69
T17265	389 262 1013	17	T17600	389 262 0123	253	T18713	(942 350 2223/SG)	101
T17266	389 262 1305	138	T17602	389 263 0410	45	T18715	(942 350 2223/SP)	102
T17267	389 262 1412	13	T17787	366 354 2512	72	T18717	(942 350 2223/W)	272
T17268	389 262 2334	226	T17788	366 354 3510	71	T18719	355 354 0417	211
T17268	389 262 0934	226	T17788	366 354 2610	71	T18740	346 354 2417	214
T17268	389 262 1934	226	T17831	389 262 8201	132	T18767	942 353 0435	87
T17269	389 263 0850	36	T17832	389 262 8301	132	T18838	389 261 1920	55
T17270	389 263 0902	51	T17832	945 262 0303	132	T18838	389 261 0520	55
T17271	389 263 1113	21	T17832	389 262 6301	132	T18838	389 261 0420	55
T17272	389 263 1631	183	T17832	945 260 0303	132	T18839	389 261 3318	55
T17369	389 262 2550	37	T17833	976 262 2501	133	T18840	389 262 1033	185
T17369	389 262 1650	37	T17833	976 262 2401	133	T18841	389 262 3713	24
T17369	389 262 0050	37	T17844	304 353 0020	102	T18841	945 262 3913	24
T17371	389 262 1733	187	T17846	304 353 0162	270	T18841	389 262 3013	24
T17372	945 262 3112	14	T17847	304 353 0362	272	T18845	389 262 6201	132
T17372	945 262 1712	14	T17848	326 353 0414	90	T18850	389 263 1210	46
T17372	945 262 1612	14	T17848	326 353 0314	90	T18851	000 353 1685	86
T17372	945 262 0812	14	T17848	326 253 0314	90	T18854	945 262 3513	19
T17372	945 262 0712	14	T17850	335 353 0015	99	T18854	945 262 1813	19
T17375	389 262 2711	10	T17862	343 586 0135	92	T18859	945 263 2913	22
T17375	945 262 3111	10	T17863	945 262 4505	139	T18877	346 354 0917	211
T17375	389 262 2011	10	T17863	945 262 3505	139	T18880	945 262 3834	220
T17378	389 262 2835	235	T18023	346 350 6039	75	T18882	945 262 6523	252
T17379	389 263 1031	184	T18023	346 350 5939	75	T18882	930 262 0523	252
T17380	945 263 2902	52	T18023	346 350 4339	75	T18883	945 262 6923	254
T17380	389 263 2502	52	T18023	346 350 2039	75	T18883	930 262 0623	254
T17380	389 263 3102	52	T18025	389 262 2405	138	T18901	389 261 4518	55
T17380	945 263 0902	52	T18285	346 350 6139	75	T18902	389 262 1210	42
T17380	389 262 1302	52	T18285	346 350 2839	75	T18903	389 263 0910	46
T17383	945 262 3605	139	T18285	346 350 2339	75	T18903	389 263 0310	46
T17383	945 262 1905	139	T18364	389 262 0535	236	T19020	346 353 0524	269
T17383	389 262 2705	139	T18365	389 262 4434	220	T19021	942 350 2123	65
T17384	945 263 3213	21	T18449	355 350 0254	60	T19023	06 02191 0523	191
T17384	945 263 0013	21	T18449	355 350 0054	60	T19033	970 262 2434	226
T17384	945 263 1713	21	T18450	(355 350 0254/G)	59	T19033	973 262 0134	226
T17384	389 263 1813	21	T18451	355 354 0317	210	T19033	971 262 0562	226
T17385	976 263 0030	170	T18586	015 997 4747	161	T19035	970 262 2534	226



TAS no.	OEM no.	Pag.	TAS no.	OEM no.	Pag.	TAS no.	OEM no.	Pag.
T19035	974 262 0034	226	T19632	389 262 1454	207	T20184	346 354 3012	96
T19035	971 262 1562	226	T19633	389 262 4452	207	T20189	355 353 9850	106
T19036	970 262 3537	240	T19634	389 262 5552	207	T20189	(MB-355)	106
T19036	970 262 1937	240	T19635	389 262 7954	206	T20224	389 262 2155	208
T19038	970 262 3837	242	T19636	017 997 3047	159	T20224	389 262 9655	208
T19038	970 262 6037	242	T19642	000933 010145	190	T20225	389 262 5752	207
T19039	970 262 3937	242	T19644	912004 010102	278	T20289	389 263 1531	183
T19039	970 262 3237	242	T19647	001 981 5087	149	T20290	389 264 0205	199
T19039	970 262 5937	242	T19656	652 350 0054	62	T20290	387 264 0105	199
T19067	385 353 0085	86	T19657	(652 350 0054/G)	60	T20290	387 264 0405	199
T19068	385 353 0115	98	T19658	TAS51379	169	T20412	653 350 0054	62
T19069	389 262 1833	186	T19658	(652 350 0054/S)	169	T20413	(653 350 0054/G)	60
T19070	389 262 5952	206	T19658	(355 350 0454/S)	169	T20414	945 262 0528	179
T19070	389 262 5852	206	T19666	976 262 1113	20	T20414	389 260 0150	179
T19072	945 267 1119	56	T19666	976 262 1013	20	T20573	946 262 6337/RING	244
T19072	389 267 4219	56	T19666	976 262 0913	20	T20573	947 260 2845 MO/RING	244
T19072	389 267 1319	56	T19666	976 262 0713	20	T20573	945 260 2245 MO/RING	244
T19072	389 267 2919	56	T19666	976 262 0113	20	T20573	947 260 0545 MO/RING	244
T19072	389 267 1419	56	T19667	976 262 1510	30	T20574	387 252 0208	254
T19076	346 354 1717	214	T19669	976 262 2105	137	T20616	385 353 0835	108
T19077	346 354 2409	62	T19669	976 262 2005	137	T20616	355 353 0835	108
T19078	346 354 2612	96	T19669	976 262 1505	137	T20618	942 350 2239	78
T19079	942 353 0135	109	T19669	976 262 1305	137	T20618	942 350 1539	78
T19079	346 353 0635	109	T19669	976 262 1105	137	T20664	389 264 0730	182
T19171	914112 014312	192	T19671	976 262 2834	223	T20664	945 264 0130	182
T19171	346 990 2501	192	T19671	976 262 0534	223	T20685	942 350 2739	77
T19171	000 990 6704	192	T19673	976 263 0810	49	T20687	942 353 0315	72
T19173	942 990 1704	192	T19677	904 350 0039	81	T20909	976 262 0210	42
T19173	308676 012022	192	T19677	602 350 2539	81	T20909	976 262 2210	42
T19173	000960 012147	192	T19718	014 997 1246	160	T20944	976 262 0345	114
T19207	914112 014313	192	T19723	942 353 0925	124	T20944	976 262 0145	114
T19207	005 990 5304	192	T19723	942 353 0825	124	T20944	976 262 0045	114
T19207	000 990 8904	192	T19723	942 353 0625	124	T20944	947 262 2745	114
T19211	(346 350 8223/CASE)	68	T19725	942 353 1045	118	T20944	947 262 0345	114
T19213	346 354 3109	63	T19725	942 353 0645	118	T20990	945 262 8234	217
T19214	346 354 4209	64	T19725	000 350 1145	118	T20990	945 262 5434	217
T19215	355 353 0735	109	T19848	389 262 1605	138	T20991	945 262 5534	220
T19309	945 262 6823	251	T19882	346 354 5709	64	T20992	945 262 9517	26
T19309	945 262 6423	251	T19883	346 356 1415	269	T20992	945 262 5617	26
T19426	337 262 0140	200	T19883	346 356 0315	269	T20993	945 262 9817	44
T19491	946 260 3661	171	T19888	385 262 0208	189	T20993	945 262 7517	44
T19491	946 260 3561	171	T19888	385 262 0008	189	T20993	945 262 5417	44
T19491	945 260 4561	171	T20034	658 357 0701	108	T20993	945 262 7617	44
T19491	945 260 4461	171	T20034	346 357 1801	108	T20995	947 260 3036	227
T19629	387 268 0773	196	T20034	346 357 0601	108	T20995	947 260 0836	227
T19630	389 262 0851	208	T20182	346 353 9850	106	T20997	947 260 3045	244
T19632	389 262 2054	207	T20182	(MB-346)	106	T20997	947 260 0945	244
T19632	389 262 1954	207	T20183	346 354 1412	95	T21059	945 260 4661	171



TAS no.	OEM no.	Pag.	TAS no.	OEM no.	Pag.	TAS no.	OEM no.	Pag.
T21059	945 260 3761	171	T37781	011 981 1905	261	T38535	945 262 1203	133
T21059	945 260 0261	171	T37781	ETA-C1R-1104	261	T38536	945 262 7734	219
T22070	976 263 0710	31	T37799	017 981 5105	267	T38536	945 262 3634	219
T22617	014 981 6105	262	T37799	017 981 2305	267	T38536	945 262 7834	219
T22617	805046/801464	262	T37799	015 981 9505	267	T38569	945 262 4710	45
T22624	002 981 7905	260	T37799	015 981 6105	267	T38569	945 262 4810	45
T22624	011 981 7605	260	T37799	014 981 2605	267	T38569	945 262 2510	45
T22624	SET 1110	260	T37813	015 981 9005	259	T38569	945 262 0210	45
T22628	004 981 9325	33	T37813	014 981 1405	259	T38569	389 262 3910	45
T22628	004 981 8925	33	T37813	013 981 0605	259	T38571	945 262 5917	45
T22628	004 981 8525	33	T37813	012 981 7405	259	T38572	017 997 2647	162
T22631	011 981 1305	266	T37813	012 981 7205	259	T38573	017 997 2747	162
T22631	580616 TR1	266	T37921	002 980 4802	257	T38573	009 997 0446	162
T22645	015 981 1605	257	T37944	015 981 2605	256	T38573	007 997 5047	162
T22645	013 981 1105	257	T38061	002 981 9501	57	T38573	007 997 3947	162
T22645	013 981 0505	257	T38065	345 981 8101	58	T38574	020 997 0647	158
T22645	012 981 8205	257	T38065	345 981 7401	58	T38574	011 997 7047	158
T22645	012 981 8105	257	T38065	001 981 1701	58	T38574	009 997 9146	158
T22649	016 981 1205	262	T38068	001 981 9905	263	T38645	T38645	214
T22649	013 981 7305	262	T38068	000 981 7705	263	T38690	015 981 7605	259
T22649	012 981 9405	262	T38068	000 981 6505	263	T38690	015 981 2005	259
T22649	012 981 9205	262	T38077	008 981 9501	58	T38690	014 981 3005	259
T22649	012 981 7505	262	T38268	017 981 7105	261	T38690	014 981 1505	259
T22716	015 997 6947	162	T38346	017 997 8147	159	T38690	014 981 0705	259
T22829	000 262 8662	159	T38346	017 997 3147	159	T38794	945 262 6702	129
T22829	000 262 9062	159	T38346	014 997 4346	159	T38794	945 262 1802	129
T22833	000 262 8762	159	T38346	009 997 1446	159	T38794	945 262 1702	129
T22833	019 997 2147	159	T38346	007 997 5147	159	T38794	945 262 1602	129
T22833	000 262 9162	159	T38378	014 981 3905	261	T38794	945 262 1502	129
T22837	000 267 0197	157	T38378	014 981 1005	261	T38796	945 262 7502	128
T22837	000 267 0397	157	T38378	014 981 0905	261	T38796	945 262 3202	128
T22839	006 997 6447	157	T38378	013 981 9905	261	T38796	945 262 3102	128
T22839	020 997 6647	157	T38378	013 981 8505	261	T38796	945 262 3002	128
T22839	012 997 3347	157	T38385	013 981 0305	257	T38796	945 262 2902	128
T22842	013 997 7247	162	T38391	002 981 4681	259	T38798	946 260 4161	171
T22842	014 997 1947	162	T38391	NP 057427	259	T38798	946 260 4061	171
T22842	013 997 5547	162	T38393	002 981 4581	264	T38800	945 262 0045	117
T22845	013 997 7347	163	T38395	013 981 0405	258	T38823	945 261 1118	55
T22845	015 997 4247	163	T38524	947 269 1001	154	T38823	945 261 0818	55
T22845	013 997 5647	163	T38524	947 269 0501	154	T38823	945 261 0118	55
T22848	024 997 8347	160	T38524	389 269 3801	154	T38824	930 262 0112	14
T22848	020 997 6747	160	T38525	945 269 0201	155	T38824	930 262 0612	14
T22848	014 997 3647	160	T38525	945 269 0101	155	T38824	948 262 0212	14
T22850	019 997 0547	158	T38534	945 263 1110	48	T38825	930 262 0403	133
T22850	023 997 7847	158	T38534	945 263 0210	48	T38825	948 262 0202	133
T22850	019 997 0347	158	T38535	389 262 7601	133	T38826	930 262 0511	10
T37781	015 981 6205	261	T38535	945 262 3201	133	T38826	930 262 0811	10
T37781	017 981 2205	261	T38535	945 262 1801	133	T38826	948 262 0011	10





TAS no.	OEM no.	Pag.	TAS no.	OEM no.	Pag.	TAS no.	OEM no.	Pag.
T38827	930 262 0805	140	T39607	008 981 2805	258	T44645	389 262 2923/M	247
T38827	930 262 2205	140	T39627	945 268 0474	167	T44646	945 262 0323/M	247
T38828	930 262 1717	45	T39627	387 268 2374	167	T44647	945 262 0423/M	248
T38828	948 262 1010	45	T39679	945 262 4410	43	T45151	389 264 0830	182
T38829	930 262 3617	43	T39690	389 269 8534	164	T45155	009 981 9805	261
T38829	948 262 1210	43	T39691	976 269 0034	164	T45155	009 981 9005	261
T38830	930 264 0320	182	T39691	960 269 0434	164	T45155	009 981 8905	261
T38831	945 262 3635	230	T39706	001 991 7860	110	T45155	009 981 8305	261
T38831	930 262 0835	230	T39706	001481 006011	110	T45155	000720 030313	261
T38831	960 262 2235	230	T39792	930 260 0124	54	T45168	970 262 0274	177
T38831	960 262 3135	230	T39792	930 260 1824	54	T45170	970 262 3034	239
T38832	930 262 0033	188	T39792	930 260 0424	54	T45170	970 262 2834	239
T38833	930 262 0133	188	T40118	675 330 0019	134	T45170	970 262 0134	239
T38833	948 262 0233	188	T40118	670 330 0219	134	T45174	970 262 3323	251
T38834	930 262 0234	217	T40136	000 350 7123	66	T45174	975 262 0223	251
T38834	930 262 0034	217	T40155	TAS40155	11	T45174	970 262 3723	251
T38926	000 350 8023	66	T40155	947 263 0112	11	T45174	694 262 0023	251
T38926	942 350 0064	66	T40155	947 263 0212	11	T45178	970 262 3437	240
T39044	945 262 3835	230	T40155	947 263 0512	11	T45178	970 262 0237	240
T39045	389 262 0973	110	T40156	TAS40156	198	T45181	970 262 3134	239
T39046	945 262 4433	187	T40495	976 262 4402	125	T45181	970 262 2934	239
T39047	945 262 0808	189	T40496	976 262 3105	136	T45181	970 262 1234	239
T39047	945 262 0208	189	T40499	976 262 1016	30	T45183	970 262 2535	233
T39048	930 262 0125	171	T41444	970 260 2054	167	T45183	974 262 0035	233
T39048	389 262 1425	171	T41447	960 260 0408	47	T45183	694 262 0335	233
T39049	389 262 0773	134	T41468	001 990 2759	193	T45187	970 262 3423	253
T39050	389 262 0251	205	T41469	960 262 0934	216	T45187	975 262 0023	253
T39051	930 264 0420	181	T41496	TAS41496	172	T45187	694 262 0123	253
T39052	389 269 1206	156	T41498	947 260 0397	174	T45187	970 262 3023	253
T39052	389 269 0706	156	T41504	TAS41504	82	T45187	970 262 2944	253
T39053	389 269 1506	155	T41629	1530 0027 510	113	T45192	970 262 3037	242
T39053	389 269 1406	155	T41629	000 435 0413	113	T45192	970 262 1537	242
T39053	389 260 0790	155	T43835	023 997 1647	163	T45192	970 262 1437	242
T39257	389 264 0223	247	T43835	015 997 7846	163	T45196	970 262 1534	223
T39258	355 354 3012	96	T44012	387 260 2873/M	140	T45196	975 262 0134	223
T39259	346 354 9709	63	T44023	930 262 0145	117	T45196	694 262 0134	223
T39260	346 354 2517	212	T44025	385 262 0645	115	T45196	693 262 0534	223
T39261	942 350 2839	77	T44025	385 262 0145	115	T45200	970 262 2923	251
T39369	389 262 0362	279	T44033	389 263 2113	22	T45200	975 262 0123	251
T39369	945 262 0062	279	T44038	389 262 2123	254	T45200	970 262 2023	251
T39371	389 990 2019	193	T44040	389 262 2023	253	T45200	972 262 2023	251
T39371	945 990 0019	193	T44042	976 262 0814	25	T45200	970 262 2123	251
T39371	389 990 0219	193	T44042	976 262 0214	25	T45205	976 981 0012	141
T39606	017 981 5705	261	T44042	389 262 1114	25	T45205	F 224451.04	141
T39606	015 981 7705	261	T44042	389 262 0914	25	T45205	002 981 6312	141
T39606	VKHB 2060	261	T44042	389 262 0814	25	T45205	002 981 6012	141
T39606	SET 1041	261	T44051	389 262 1134	216	T45205	002 981 5912	141
T39606	014 981 3105	261	T44595	387 260 2873	39	T45210	970 993 6401	209



TAS no.	OEM no.	Pag.	TAS no.	OEM no.	Pag.	TAS no.	OEM no.	Pag.
T45210	970 993 4601	209	T45584	970 262 1612	15	T45644	976 262 1634	222
T45210	970 993 1801	209	T45584	970 262 1312	15	T45644	976 262 1734	222
T45210	970 993 3501	209	T45584	970 262 1012	15	T45646	976 262 1705	137
T45215	970 261 0333	54	T45584	695 262 0112	15	T45646	976 262 1405	137
T45215	970 261 0233	54	T45590	695 262 0034	224	T45646	976 262 2905	137
T45215	970 261 0633	54	T45590	975 262 0034	224	T45646	975 262 0005	137
T45218	970 262 2435	232	T45593	695 262 0035	233	T45649	976 263 0216	31
T45218	694 262 0235	232	T45595	970 260 2844	237	T45649	976 263 0016	31
T45218	693 262 0035	232	T45597	970 260 2944	237	T45649	695 263 0016	31
T45221	013 997 2646	158	T45600	970 262 0835	118	T45649	975 263 0116	31
T45221	021 997 1747	158	T45600	975 262 0135	118	T45649	970 263 0016	31
T45221	021 997 2547	158	T45600	694 262 0035	118	T45654	976 263 1110	49
T45225	024 997 3247	158	T45600	693 262 0135	118	T45654	976 263 1210	49
T45225	024 997 2747	158	T45604	970 262 1114	25	T45654	695 263 0010	49
T45225	020 997 7247	158	T45604	975 262 0114	25	T45654	975 263 0110	49
T45231	976 262 0462	278	T45604	695 262 0014	25	T45654	693 263 0010	49
T45231	695 262 0062	278	T45604	970 262 1214	25	T45660	947 260 0945 MO/RING	244
T45232	970 262 1902	131	T45609	975 262 0334	221	T45660	947 260 3045 MO/RING	244
T45232	970 262 2002	131	T45609	970 262 1734	221	T45738	942 353 0401	67
T45236	976 262 1702	127	T45609	694 262 0234	221	T45739	942 353 0428	153
T45236	976 262 1802	127	T45611	975 262 0234	222	T45740	TAS45740	105
T45239	970 263 0713	22	T45611	970 262 2334	222	T45741	TAS45741	97
T45239	975 263 0113	22	T45611	694 262 0334	222	T45741	(000 350 8023/SP)	97
T45239	694 263 0013	22	T45613	970 263 0331	184	T45742	001 990 5000	192
T45239	970 263 0613	22	T45613	970 263 0231	184	T45744	TAS45744	88
T45301	945 262 3333	187	T45613	694 263 0031	184	T46608	016 981 0010	148
T45301	389 262 2133	187	T45613	694 263 0131	184	T46608	F-219518	148
T45486	389 267 2819	56	T45613	970 263 0031	184	T46608	015 981 9810	148
T45486	389 267 2719	56	T45618	970 263 0702	53	T46608	018 981 8610	148
T45486	389 267 1519	56	T45618	975 263 0102	53	T46608	018 981 8710	148
T45491	001 260 8457	275	T45618	694 263 0002	53	T46615	018 981 6610	147
T45491	001 260 4757	275	T45618	970 263 0802	53	T46615	F-95451.02	147
T45491	001 260 3557	275	T45623	970 981 0081	38	T46615	010 981 5310	147
T45491	000 260 5457	275	T45625	976 262 0502	127	T46615	010 981 6410	147
T45570	018 981 5710	141	T45625	976 262 0202	127	T46615	012 981 9310	147
T45570	017 981 6110	141	T45627	976 262 0816	29	T46626	009 981 1510	146
T45570	017 981 6010	141	T45627	976 262 0916	29	T46626	018 981 7510	146
T45570	F-224448.K-HLA	141	T45627	976 262 0216	29	T46626	008 981 9310	146
T45574	975 262 0113	20	T45627	976 262 0516	29	T46626	012 981 9110	146
T45574	970 262 1213	20	T45627	976 262 0116	29	T46626	017 981 7810	146
T45574	970 262 1113	20	T45633	976 262 0835	233	T46630	012 981 8910	142
T45574	694 262 0013	20	T45633	976 262 0935	233	T46630	F-207054	142
T45580	976 262 1411	11	T45638	976 262 1205	137	T46630	012 981 9010	142
T45580	975 262 0111	11	T45638	976 262 0705	137	T46630	013 981 0210	142
T45580	970 262 0511	11	T45640	976 262 1402	127	T46630	019 981 1310	142
T45580	970 262 0311	11	T45640	976 262 1502	127	T46634	019 981 4410	145
T45580	695 262 0011	11	T45640	975 262 0102	127	T46634	F-57368.01	145
T45584	975 262 0112	15	T45640	695 262 0002	127	T46634	007 981 4210	145



TAS no.	OEM no.	Pag.	TAS no.	OEM no.	Pag.	TAS no.	OEM no.	Pag.
T46634	008 981 8310	145	T49287	970 262 1652	281	T49931	028 997 2248	152
T46634	009 981 0010	145	T49288	970 262 1552	281	T49931	019 997 7248	152
T46657	301 353 0020	104	T49289	970 262 1452	280	T49932	020 997 7848	166
T46660	385 353 0114	91	T49290	970 262 1352	280	T49953	017 997 1847	157
T47537	008 981 1325	34	T49291	970 262 1252	280	T49960	387 262 8773	197
T47537	F-221001	34	T49292	970 262 1152	280	T49961	387 262 8673	197
T47545	008 981 3025	33	T49293	976 262 1094	112	T49962	945 262 4403	132
T47545	F-805045	33	T49293	976 262 0694	112	T49962	945 262 1001	132
T47602	542 030 0205	118	T49294	976 262 1194	112	T49962	389 262 0003	132
T47602	541 030 0105	118	T49295	976 262 1294	112	T49962	945 262 0703	132
T49097	TAS49097	105	T49295	976 262 0894	112	T49962	389 262 5601	132
T49098	TAS49098	106	T49296	976 262 0062	279	T49964	007993 050200	110
T49125	945 267 1319	57	T49298	970 994 1141	180	T49965	945 990 0250	151
T49125	945 267 1619	57	T49299	970 262 0494	111	T49965	945 990 0150	151
T49218	009 981 5525	32	T49300	970 262 0394	111	T49965	945 990 0050	151
T49218	800574 A	32	T49301	970 262 0294	111	T49970	389 261 0665	154
T49218	007 981 0525	32	T49302	970 262 0194	111	T49970	389 262 9454	154
T49227	018 981 3610	142	T49303	018 981 5610	143	T49970	389 261 0765	154
T49227	F-225955	142	T49303	017 981 5310	143	T49974	942 353 1245	117
T49227	018 981 0110	142	T49303	017 981 5210	143	T49974	942 353 0845	117
T49227	018 981 3010	142	T49304	970 262 0533	188	T49974	942 353 0745	117
T49233	023 981 8210	144	T49304	975 262 0133	188	T49978	389 262 0945	117
T49233	018 981 9510	144	T49304	695 262 0133	188	T49978	945 262 0345	117
T49233	017 997 5710	144	T49304	970 262 0433	188	T49996	389 994 0041	196
T49233	017 981 5710	144	T49304	695 262 0233	188	T50005	007 994 0041	196
T49233	017 981 5610	144	T49308	007603 024105	278	T50005	387 262 2273	196
T49240	023 981 3810	147	T49309	210 997 0032	176	T50005	387 262 2073	196
T49240	018 981 9610	147	T49309	124 997 0132	176	T50006	387 262 2173	195
T49240	018 981 5810	147	T49313	210 997 0132	176	T50019	389 262 3552	280
T49245	018 981 5310	145	T49313	115 997 0032	176	T50020	389 262 3754	208
T49245	017 981 5010	145	T49324	970 262 0362	279	T50020	945 262 0152	208
T49245	002 981 6112	145	T49324	383 282 0262	279	T50020	945 262 0052	208
T49245	017 981 5110	145	T49325	910105 016005	193	T50021	007 994 1841	195
T49252	023 981 8510	143	T49325	000000 005536	193	T50021	006 994 9941	195
T49252	023 981 2910	143	T49331	970 260 1554	167	T50027	022 997 4248	166
T49252	019 981 5710	143	T49331	970 260 0754	167	T50029	945 267 0218	168
T49252	019 981 5310	143	T49332	947 265 0849	202	T50029	387 267 0918	168
T49258	002 981 7512	58	T49332	976 265 0049	202	T50029	387 267 0618	168
T49258	010 981 4901	58	T49332	967 265 0149	202	T50069	947 265 2701	118
T49258	010 981 8401	58	T49404	945 261 1033	54	T50069	947 265 2601	118
T49268	970 263 0093	203	T49544	945 267 0819	56	T50069	947 265 0801	118
T49269	970 994 1941	203	T49544	945 267 0719	56	T50069	389 265 0901	118
T49282	976 262 2302	127	T49544	945 267 0119	56	T50069	389 265 0201	118
T49282	976 262 2402	127	T49544	945 267 0019	56	T50074	020 997 8948	166
T49283	970 262 2052	282	T49901	015 997 2848	165	T50074	013 997 7548	166
T49284	970 262 1952	281	T49901	020 997 8548	165	T50075	000472 060000	195
T49285	970 262 1852	281	T49905	945 261 0580	119	T50076	945 269 0834	163
T49286	970 262 1752	281	T49905	945 261 0080	119	T50076	389 269 4734	163



TAS no.	OEM no.	Pag.	TAS no.	OEM no.	Pag.	TAS no.	OEM no.	Pag.
T50078	000472 130000	197	T51411	301 350 0727	59	T53120	656 262 0805	137
T50081	000471 120000	197	T51534	945 262 1617	19	T53120	389 262 4505	137
T50088	389 262 0645	117	T51534	945 262 1913	19	T53120	389 262 4605	137
T50089	014 997 5148	165	T51534	945 262 1313	19	T53120	389 262 4005	137
T50089	020 997 8648	165	T51667	945 990 0600	193	T53120	389 262 3205	137
T50090	945 262 0762	279	T51667	945 990 0100	193	T53124	389 263 3402	51
T50091	910105 020025	193	T51686	945 262 5034	217	T53124	389 263 2702	51
T50091	000000 006750	193	T51686	389 262 9934	217	T53124	389 263 2402	51
T50091	000000 005728	193	T51686	389 262 5734	217	T53130	656 262 6102	130
T50092	945 264 0520	181	T51697	389 262 4435	236	T53130	656 262 6082	130
T50093	945 264 0420	181	T51699	945 262 5623	254	T53130	656 262 3282	130
T50093	945 264 0220	181	T51701	945 262 5723	253	T53130	389 262 6602	130
T50094	945 264 0620	181	T51703	945 262 5934	221	T53130	389 262 6502	130
T50099	947 269 1110	199	T51705	945 262 6034	221	T53132	656 262 4413	20
T50099	945 269 1110	199	T51707	945 262 6134	216	T53132	656 262 0013	20
T50100	947 269 1010	199	T51709	945 262 7134	222	T53132	389 262 4413	20
T50100	945 269 1010	199	T51796	972 262 0089	240	T53132	389 262 4313	20
T50100	945 268 1210	199	T51796	972 262 0189	240	T53132	389 262 3613	20
T50112	029 997 5748	164	T51796	972 262 0289	240	T53137	945 262 6417	20
T50151	346 354 3017	213	T51901	970 262 1535	235	T53139	389 262 0716	30
T50803	945 262 0109	213	T51901	970 262 1235	235	T53139	389 262 0816	30
T50803	945 262 0209	213	T51905	970 262 0405	139	T53139	389 262 0116	30
T50812	930 262 0123	248	T51905	970 262 1005	139	T53139	389 262 0416	30
T50812	945 262 5223	248	T51905	970 262 0205	139	T53143	389 263 1910	49
T50812	930 262 0723	248	T51908	970 263 0610	50	T53143	389 263 2710	49
T50812	960 262 1523	248	T51908	970 263 0510	50	T53146	656 263 0013	22
T50815	947 262 1123	247	T51908	970 263 0410	50	T53146	389 263 3013	22
T50815	947 262 0423	247	T51908	694 263 0010	50	T53146	389 263 2713	22
T50815	947 262 1423	247	T51922	345 350 0054	92	T53149	389 269 2001	155
T50815	947 262 2223	247	T51937	301 353 0115	101	T53149	389 269 1901	155
T51119	976 262 1515	28	T51970	694 262 0135	228	T53152	656 269 0001	154
T51119	976 262 0015	28	T51992	017 981 3510	144	T53152	629 269 0001	154
T51119	976 262 0915	28	T51994	017 981 3610	144	T53154	389 269 1606	155
T51119	976 262 1615	28	T51996	017 981 3710	142	T53154	389 269 1706	155
T51361	942 350 2539	79	T51998	017 981 3810	143	T53156	945 262 4082	129
T51363	942 350 3039	80	T51998	K55X60X20	143	T53218	942 353 0134	70
T51363	942 350 2139	80	T52102	389 265 0049	203	T53250	947 260 0736	227
T51363	942 350 1439	80	T52217	017 981 1305	257	T53252	947 264 0420	181
T51363	942 350 1339	80	T52217	EC43994S01	257	T53254	947 260 6361	170
T51368	000 350 4403	179	T52380	017 997 9947	159	T53256	947 262 0634	215
T51370	355 350 0454	61	T52380	018 997 4947	159	T53260	960 262 0191	107
T51377	TAS51377	60	T52380	018 997 7347	159	T53260	960 262 0091	107
T51377	(355 350 0454/G)	60	T52390	012 981 3605	259	T53260	947 260 4036	107
T51389	386 350 7823	64	T52390	JXC25690 C/JXC25690 DC	259	T53261	947 262 1705	136
T51400	000 350 0054	93	T52395	012 981 3705	263	T53261	947 262 1605	136
T51401	346 354 3212	96	T52395	015 981 4005	263	T53261	947 262 1505	136
T51406	355 981 0187	149	T52402	019 981 6010	143	T53261	947 262 0705	136
T51406	000 981 1787	149	T52402	019 981 5810	143	T53264	947 260 0297	175





TAS no.	OEM no.	Pag.	TAS no.	OEM no.	Pag.	TAS no.	OEM no.	Pag.
T53264	947 260 0197	175	T55339	945 263 1813	20	T56481	386 981 7405	264
T53265	TAS53265	172	T55339	945 263 1913	20	T56487	021 981 9410	147
T53285	930 262 2105	136	T55339	945 263 1213	20	T56487	019 981 0610	147
T53285	930 262 1305	136	T55344	945 263 2202	53	T56487	008 981 8510	147
T53556	674 350 0339	73	T55344	945 263 2302	53	T56487	019 981 6210	147
T53556	688 350 0039	73	T55344	945 263 0302	53	T56487	008 981 9810	147
T53556	688 350 0239	73	T55344	945 263 0402	53	T56493	020 997 9947	162
T53556	378 350 0039	73	T55350	945 262 2123	248	T56493	021 997 0047	162
T53556	318 350 1439	73	T55466	945 981 0010	145	T56493	007 997 3847	162
T54147	004 981 2105	255	T55466	008 981 9210	145	T56493	009 997 0646	162
T54147	004 981 4905	255	T55466	018 981 7610	145	T56493	008 997 0347	162
T54147	007 981 0005	255	T55466	018 981 8110	145	T56494	023 997 8847	160
T54160	004 981 0905	256	T55466	019 981 2310	145	T56494	023 997 8547	160
T54378	694 262 0115	28	T55470	015 981 1705	257	T56494	020 997 6447	160
T54380	970 263 0615	29	T55470	014 981 8805	257	T56494	007 997 8446	160
T54380	970 263 0515	29	T55470	021 981 2205	257	T56498	015 981 4110	142
T54380	694 263 0015	29	T55853	385 262 0674	177	T56498	019 981 0510	142
T54591	946 356 0015	188	T55902	010 981 6305	258	T56551	019 981 9210	141
T54592	355 356 1215	206	T55902	010 981 5905	258	T56551	020 981 0110	141
T54592	355 356 0915	206	T55902	009 981 0305	258	T56551	023 981 1210	141
T54674	945 262 7234	223	T55902	006 981 5405	258	T56551	023 981 5110	141
T54685	019 981 3410	148	T55902	006 981 4205	258	T56709	385 350 4339	81
T54685	018 981 7910	148	T55915	009 981 6205	266	T56709	652 350 0739	81
T54685	018 981 7410	148	T55915	009 981 4705	266	T56709	617 350 0139	81
T54685	018 981 0410	148	T55915	009 981 1005	266	T56709	384 350 0039	81
T54685	017 981 7910	148	T55915	009 981 0605	266	T56713	389 262 1862	205
T54693	300 350 0039	74	T55915	001 981 8505	266	T56715	389 262 7035	231
T54693	652 350 0239	74	T55946	002 260 6257	276	T56715	389 262 4135	231
T54698	389 262 5335	234	T56241	014 981 2205	266	T56717	389 262 5635	237
T54700	694 262 0034	223	T56241	012 981 8405	266	T56717	389 262 3335	237
T54702	389 263 2910	49	T56273	005 981 4905	255	T56722	389 263 0116	31
T54702	389 263 2510	49	T56273	003 981 2805	255	T56724	389 269 2101	155
T54702	389 263 2110	49	T56273	003 981 2605	255	T56724	389 269 2201	155
T54743	656 262 2882	130	T56273	000 980 9702	255	T56952	947 262 0334	216
T54743	656 262 9802	130	T56273	000 352 0114	255	T56954	947 262 0709	214
T55055	970 260 0344	11	T56291	001 981 7205	255	T56954	947 262 0809	214
T55055	970 260 3644	11	T56291	017 981 7905	255	T56957	947 260 0097	175
T55299	015 997 4048	166	T56291	006 981 5505	255	T56959	947 262 1208	189
T55325	945 262 5912	13	T56291	006 981 0405	255	T56959	947 262 1108	189
T55325	945 262 6112	13	T56291	004 981 7405	255	T56959	947 262 1308	189
T55325	945 262 0412	13	T56480	018 997 5147	161	T56971	TAS56971	172
T55331	945 262 1205	138	T56480	016 997 6647	161	T57122	018 981 6410	146
T55333	945 262 2023	249	T56480	005 997 7647	161	T57208	028 997 2348	164
T55335	945 262 8311	134	T56480	005 997 6947	161	T57208	004 997 2248	164
T55335	945 262 8211	134	T56480	005 997 6747	161	T57217	022 981 7910	146
T55335	945 262 8111	134	T56481	003 981 1205	264	T57217	022 981 5310	146
T55335	945 262 7911	134	T56481	003 981 1905	264	T57220	000 994 9841	194
T55335	945 262 7811	134	T56481	386 981 7105	264	T57222	947 260 4645	245



TAS no.	OEM no.	Pag.	TAS no.	OEM no.	Pag.	TAS no.	OEM no.	Pag.
T57222	947 260 3545	245	T58300	947 265 0449	203	T60232	942 353 0215	72
T57222	947 260 2945	245	T58335	944 350 0523	66	T60243	946 353 0015	97
T57222	947 260 1945	245	T58358	945 262 3735	234	T60247	946 353 0014	88
T57222	947 260 0745	245	T58358	945 262 1835-OLD	234	T60251	389 269 1310	156
T57225	023 981 5210	147	T58362	009 981 4510	144	T60251	389 269 0810	156
T57225	022 981 5410	147	T58362	019 981 9110	144	T60449	389 262 9834	222
T57225	022 981 5810	147	T58362	009 981 1910	144	T60460	003 981 2905	265
T57225	022 981 8510	147	T58371	011 981 0705	264	T60469	003 981 3205	265
T57229	930 262 0205	140	T58371	006 981 1905	264	T60469	000 981 4218	265
T57231	022 981 5510	147	T58371	006 981 1705	264	T60469	003 981 3005	265
T57231	022 981 5910	147	T58375	006 981 3505	264	T60469	008 981 0305	265
T57231	024 981 2410	147	T58375	009 981 6905	264	T60798	000472 100000	196
T57247	930 263 0031	185	T58375	006 981 3405	264	T60798	970 994 3541	196
T57247	948 263 0231	185	T58390	003 981 4925	33	T60893	TAS60893	106
T57249	010 981 9025	32	T58390	003 981 4525	33	T60920	346 354 1917	213
T57249	010 981 8425	32	T58390	000625 036214	33	T60937	944 353 0328	153
T57249	008 981 5425	32	T58394	002 981 8125	32	T60941	001 990 0103	191
T57249	008 981 3425	32	T58394	000625 036211	32	T60943	TAS60943	67
T57257	013 997 0148	165	T58398	944 350 0243	123	T60943	944 350 0623/CASE	67
T57261	015 997 2748	165	T58398	944 353 0225	123	T60952	002 981 1105	262
T57269	930 267 0618	168	T58398	944 353 0325	123	T60975	008 981 8305	263
T57269	960 267 0118	168	T58400	005 981 4605	260	T60975	006 981 8805	263
T57275	930 263 1910	120	T58400	003 981 9005	260	T60975	005 981 4705	263
T57277	930 263 0112/GEAR	12	T58400	003 981 8905	260	T60975	003 981 8205	263
T57279	022 981 6010	145	T58400	003 981 8805	260	T60975	003 981 4105	263
T57279	022 981 5610	145	T58413	005 981 5925	33	T60990	013 981 2610	145
T57280	007603 042101	194	T58413	005 981 6025	33	T60990	013 981 1810	145
T57313	930 262 1205	139	T58413	000625 036212	33	T60990	013 981 1710	145
T57313	930 262 2405-OLD	139	T58422	021 981 1710	148	T61084	355 353 2062	274
T57626	682 353 7015	101	T58422	019 981 9910	148	T61084	355 353 0862	274
T57627	682 353 7020	104	T58422	019 981 9810	148	T61089	TAS61089	94
T57629	696 357 0101	179	T58423	019 981 9010	141	T61090	TAS61090	37
T58207	930 262 0605	135	T58423	020 981 0010	141	T61097	970 260 2544	15
T58207	930 262 0305	135	T58426	016 997 6747	161	T61097	970 260 2244	15
T58207	930 260 0605	135	T58515	014 981 7905	260	T61106	970 260 2344	25
T58210	930 262 0613	19	T58518	014 981 7805	263	T61106	970 260 0914	25
T58210	930 262 0413	19	T59106	976 262 1612	15	T61109	970 262 0105	138
T58210	945 262 9713	19	T59106	976 262 1512	15	T61112	970 262 0502	128
T58210	945 262 9613	19	T59106	389 262 2712	15	T61112	970 262 0602	128
T58214	945 262 6812	15	T59115	389 262 3311	10	T61191	TAS61191	82
T58214	945 262 5612	15	T59115	389 262 3411	10	T61191	9483531212+1710	82
T58214	945 262 5512	15	T59115	389 262 2511	10	T61195	TAS61195	74
T58214	930 262 0312	15	T59285	668 350 0739	73	T61825	945 262 3935	231
T58295	930 262 0233	186	T59285	668 350 0439	73	T61826	002 981 8181	263
T58296	930 262 2217	41	T59285	668 350 0139	73	T61826	F-563007.RTR1	263
T58296	945 262 3017	41	T59781	000 353 1585	86	T61827	TAS61827	119
T58296	945 262 3117	41	T59781	942 353 0185	86	T61840	389 262 0150	36
T58296	945 262 3617	41	T60230	942 353 0235	109	T61849	000 353 1885	85



TAS no.	OEM no.	Pag.	TAS no.	OEM no.	Pag.	TAS no.	OEM no.	Pag.
T61849	944 353 0285	85	T63113	301 350 1339	81	T64059	654 410 0222	178
T61853	000 353 1785	85	T63113	302 350 1139	81	T64059	654 410 0022	178
T61853	944 353 0185	85	T63113	344 350 0239	81	T64059	620 410 0022	178
T61859	944 353 0385	71	T63113	383 350 0639	81	T64059	389 410 0222	178
T61862	944 353 0085	71	T63113	301 350 0539	81	T64059	389 410 0122	178
T61866	016 981 0105	260	T63124	TAS63124	94	T64064	404 200 0226	113
T61866	016 981 0205	260	T63127	942 353 0062	272	T64065	656 411 0012	178
T61866	016 981 0305	260	T63139	014 981 2105	264	T64066	TAS64066	112
T61866	016 981 1605	260	T63139	014 981 2005	264	T64126	027 997 2248	152
T61866	016 981 0005	260	T63230	945 262 2711	10	T64126	016 997 4048	152
T61890	389 262 7902	130	T63230	945 262 2911	10	T64126	008 997 7545	152
T61890	389 262 7802	130	T63230	945 262 2311	10	T64126	002 997 4248	152
T61893	389 262 8102	130	T63237	945 262 2035	231	T64126	001 997 6848	152
T61893	389 262 8002	130	T63237	945 262 2135	231	T64524	942 353 0159	161
T61896	389 262 9734	223	T63242	389 262 0545	116	T64575	942 350 2439	80
T61898	389 262 1615	28	T63242	945 262 0145	116	T64583	942 353 0180	119
T61910	945 262 4934	221	T63244	945 263 0231	183	T64873	000 350 0413	179
T61910	389 262 8334	221	T63244	945 263 0431	183	T64873	000 586 1235	179
T61913	945 262 4834	221	T63244	945 263 0331	183	T64970	TAS64970	94
T61913	389 262 8234	221	T63263	000 264 1960	194	T65001	007 981 7901	57
T61918	389 262 2233	188	T63273	945 262 4202	129	T65001	007 981 7801	57
T61918	389 262 2733	188	T63411	346 354 3712	95	T65001	003 981 9001	57
T61921	389 262 4235	230	T63423	389 325 2152	151	T65012	002 981 2605	265
T61923	027 997 3048	194	T63425	389 990 5060	124	T65012	002 981 1605	265
T61923	023 997 6048	194	T63435	947 260 1961	171	T65037	930 430 0087	276
T61923	023 997 5548	194	T63435	947 260 4561	171	T65121	653 353 9750	180
T61930	900055 060300	195	T63435	947 260 9361	171	T65126	011 997 3746	157
T61930	000 264 5351	195	T63438	970 353 0025	124	T65132	007 981 0201	58
T61934	389 263 1931	184	T63506	TAS63506	119	T65159	TAS65159	179
T61936	389 263 0915	29	T63507	TAS63507	163	T65192	947 262 5310	9
T61936	389 263 0815	29	T63508	TAS63508	153	T65192	947 262 5110	9
T61936	389 263 0415	29	T63509	TAS63509	153	T65192	948 262 0610	9
T61944	013 997 0048	166	T63510	TAS63510	163	T65199	930 260 0263	121
T61957	942 981 0205	265	T63534	016 981 4405	260	T65223	947 262 1911	9
T61957	327 981 0305	265	T63534	016 981 7881	260	T65223	947 262 1611	9
T61957	001 981 4805	265	T63534	002 981 7981	260	T65271	947 263 0111	11
T61957	000 981 8405	265	T63561	019 997 8348	165	T65325	947 262 0612	14
T61957	000 981 7405	265	T63630	018 997 7147	160	T65325	947 262 0412	14
T61994	960 265 0774	167	T63701	656 262 0434	222	T65325	947 262 2912	14
T61994	960 265 0574	167	T63703	656 262 0016	30	T65335	947 262 2012	14
T61994	945 265 2974	167	T63705	656 262 0335	234	T65335	947 262 1012	14
T61994	945 265 2774	167	T63707	656 263 0016	31	T65335	947 262 0912	14
T61994	945 265 1974	167	T64052	403 200 0926	113	T65335	947 262 0812	14
T62060	389 262 3473	196	T64052	402 200 0126	113	T65335	947 262 2412	14
T62265	945 260 7224	54	T64055	655 410 0022	178	T65419	930 262 0513	18
T62434	945 262 3533	186	T64055	620 410 0010	178	T65419	930 262 0213	18
T62434	945 262 4133	186	T64055	395 410 0622	178	T65419	930 262 0113	18
T62434	945 262 0633	186	T64055	395 410 0022	178	T65419	930 262 0013	18



TAS no.	OEM no.	Pag.	TAS no.	OEM no.	Pag.	TAS no.	OEM no.	Pag.
T65433	947 262 0613	19	T65989	930 263 2610	47	T67089	012 981 9410	146
T65433	947 262 0413	19	T65989	930 263 0510	47	T67089	009 981 1610	146
T65479	947 263 0413	21	T65989	930 263 0410	47	T67089	008 981 9410	146
T65479	947 263 0513	21	T66000	930 263 2510	48	T67131	976 990 0150	151
T65571	TAS65571	174	T66000	930 263 0210	48	T67131	976 990 0050	151
T65633	976 263 0215	29	T66000	930 263 0110	48	T67200	015 997 7746	161
T65633	976 263 0615	29	T66073	947 263 2402	50	T67217	389 269 0134	164
T65695	008 981 9525	35	T66111	947 263 0702	52	T67445	947 262 1933	182
T65697	009 981 0325	35	T66114	930 263 0202	52	T67445	947 262 1433	182
T65697	6213/C3	35	T66117	930 263 0602	52	T67445	947 262 1533	182
T65699	009 981 0510	34	T66141	930 260 2124	53	T67445	947 262 1633	182
T65714	001 981 3105	35	T66531	947 263 1713	120	T67445	947 262 2533	182
T65714	006 981 5305	35	T66531	947 263 1613	120	T67447	947 263 1231	182
T65714	001 981 5005	35	T66531	945 263 5613	120	T67447	947 263 1431	182
T65714	006 981 4305	35	T66531	945 263 5513	120	T67447	947 263 1131	182
T65728	008 981 5201	35	T66531	945 263 5413	120	T67447	947 263 1031	182
T65728	007 981 5701	35	T66533	945 263 7313	120	T67454	947 263 0731	183
T65728	006 981 2801	35	T66533	945 263 5813	120	T67592	947 262 2508	190
T65728	004 981 3301	35	T66533	945 263 5713	120	T67705	387 262 0473	195
T65728	004 981 3101	35	T66536	947 263 2910	121	T67824	TAS67824	41
T65734	009 981 3325	33	T66536	947 263 0910	121	T67825	002 260 9563	57
T65734	009 981 3625	33	T66545	947 260 3045/RING	243	T67825	001 260 8463	57
T65734	009 981 3525	33	T66552	947 260 2845/RING	243	T67825	003 260 3963	57
T65734	009 981 3425	33	T66628	960 260 3318	194	T67907	947 265 0649	202
T65899	967 981 0012	141	T66628	947 260 0718	194	T67907	947 265 0149	202
T65930	930 262 0717	41	T66679	387 262 1301	125	T68093	945 260 1957	276
T65930	960 262 0617	41	T66794	976 262 0914	120	T68093	405 264 0389	276
T65930	960 262 0517	41	T66794	970 262 1514	120	T68238	387 993 2101	209
T65930	948 262 2210	41	T66794	967 262 0114	120	T68241	387 993 2201	209
T65930	948 262 2310	41	T66797	976 262 3434	216	T68270	947 262 1609	212
T65933	947 262 3510	41	T66801	970 262 0505	135	T68270	947 262 1309	212
T65948	930 262 3117	43	T66813	930 262 1003	133	T68270	947 262 1209	212
T65948	930 262 0217	43	T66813	930 262 0003	133	T68270	947 262 1109	212
T65948	930 262 0117	43	T66843	967 260 0124	53	T68270	947 262 1009	212
T65951	947 262 5210	43	T66844	TAS66844	140	T68311	000 996 9445	34
T65951	947 262 0210	43	T66847	TAS66847	119	T68311	000 996 6745	34
T65951	947 262 0310	43	T66884	947 262 1811	135	T68315	000 996 9345	34
T65951	947 262 2110	43	T66884	947 262 1311	135	T68315	000 996 6645	34
T65951	947 262 2210	43	T66947	947 262 0305	135	T68320	000 996 9645	34
T65956	930 262 3217	44	T67005	021 981 5210	144	T68341	945 262 5734	215
T65956	930 262 0517	44	T67028	017 981 8305	190	T68387	005 997 6736	204
T65956	930 262 0417	44	T67044	022 981 2310	143	T68471	389 262 1135	228
T65960	947 262 0117	44	T67044	022 981 2210	143	T68478	389 262 2735	228
T65960	947 262 1510	44	T67079	TAS67079	238	T68492	947 262 0135	234
T65963	930 262 2417	44	T67081	TAS67081	237	T68495	947 262 0435	233
T65963	930 262 1517	44	T67085	022 981 2110	146	T68498	947 262 0735	227
T65963	945 262 4717	44	T67085	022 981 2010	146	T68498	947 262 0835	227
T65963	945 262 4817	44	T67089	019 981 0810	146	T68563	675 262 0137	240





TAS no.	OEM no.	Pag.	TAS no.	OEM no.	Pag.	TAS no.	OEM no.	Pag.
T68586	381 262 0223	246	T70978	948 353 0101	67	T75409	346 350 4639	80
T68586	381 262 0523	246	T70980	948 353 0062	270	T75409	346 350 3839	80
T69103	947 260 2845	245	T70982	948 353 0015	98	T75409	346 350 7839	80
T69103	947 260 0545	245	T70982	TAS70982	98	T75458	970 262 3134 CB	243
T69103	945 260 2245	245	T70984	948 353 0021	88	T75470	970 262 3034 CB	242
T69141	976 262 1594	111	T70986	948 353 0121	97	T75553	972 262 0089 CB	242
T69142	976 262 1794	110	T70988	948 353 0014	92	T75565	972 262 0135	229
T69145	970 265 0449	201	T70988	TAS70988	92	T75565	971 262 0635	229
T69151	970 263 0602	53	T70990	948 353 0024	268	T75567	971 262 1323	248
T69151	970 263 0402	53	T70993	345 981 7501	58	T75567	971 262 0323	248
T69151	970 263 0302	53	T70993	006 981 1901	58	T75567	972 262 0523	248
T69160	970 260 5031	118	T70993	003 981 1701	58	T75582	972 262 0735	229
T69162	970 262 2252	282	T70993	001 981 0001	58	T75582	973 262 0335	229
T69163	970 262 2152	282	T70993	000 981 9701	58	T75625	016 981 7305	256
T69290	656 262 8082	130	T71055	948 350 0023	66	T75625	016 981 3005	256
T69315	656 262 0116	30	T71057	675 353 0215	99	T75625	016 981 3105	256
T69317	656 262 0211	10	T72773	308748 006003	110	T75632	016 981 7205	258
T69368	930 262 0333	185	T73032	655 254 0206	40	T75632	015 981 3405	258
T69373	945 262 0206	173	T73069	000 254 0017	190	T75632	015 981 3805	258
T69388	001 260 4963	56	T73116	009 981 4305	266	T75632	015 981 5605	258
T69431	TAS69431	239	T73116	011 981 2305	266	T75667	976 262 3234	241
T69735	656 262 0435	234	T73116	011 981 3605	266	T75667	976 262 3034	241
T69742	TAS69742	31	T73648	930 438 0510	198	T75746	695 350 0140	84
T70053	301 350 2339	74	T73650	930 438 0610	198	T75750	615 353 0114	90
T70074	012 542 5617	275	T73650	1530.01834	198	T75752	694 353 0062	271
T70074	012 542 7117	275	T73704	943 260 1209	215	T75766	948 350 0103	125
T70124	TAS70124	172	T73704	943 260 0809	215	T75812	327 990 0012	191
T70139	016 981 5605	259	T73704	943 260 0209	215	T75814	327 991 0060	167
T70478	TAS70478	153	T73714	943 260 1509	214	T75817	TAS75817	68
T70569	070952 060102	134	T73714	943 260 0509	214	T75818	TAS75818	68
T70694	016 981 1505	255	T73716	002 295 0706	40	T75820	TAS75820	68
T70694	016 981 0705	255	T73879	TAS52215	23	T75821	TAS75821	68
T70694	016 981 0605	255	T73880	TAS52216	23	T75822	TAS75819	114
T70694	016 981 0505	255	T73880	TAS60607	23	T75828	386 990 0201	191
T70694	016 981 0405	255	T73946	007 542 2418	198	T75829	386 990 0301	192
T70725	946 262 6137	245	T73946	008 542 7118	198	T75830	912006 010001	277
T70725	947 260 2945 MO	245	T73946	006 542 5218	198	T75990	309 353 0115	99
T70725	947 260 0745 MO	245	T73952	004 542 5018	275	T76030	945 262 4282	129
T70725	947 260 1945 MO	245	T73982	TAS73982	97	T76030	945 262 4182	129
T70725	947 260 3545 MO	245	T74627	TAS74627	94	T76135	001 540 5217	267
T70729	946 262 6137/RING	244	T74722	000 260 3298	215	T76135	000 821 0081	267
T70803	960 262 0105	140	T74803	TAS74803	39	T76220	TAS76220	94
T70803	948 262 0205	140	T74891	654 411 0511	275	T76483	023 997 1048	152
T70803	960 262 3805	140	T74891	389 411 0411	275	T76483	023 997 7748	152
T70807	960 262 0009	213	T75152	007 542 7418	198	T76483	022 997 7748	152
T70807	948 262 0209	213	T75384	006 981 7605	265	T76723	668 350 0026	84
T70814	930 263 0402	52	T75384	005 981 6905	265	T76723	463 280 0040	84
T70978	948 353 0001	67	T75384	005 981 5505	265	T76723	460 586 0135	84



TAS no.	OEM no.	Pag.	TAS no.	OEM no.	Pag.	TAS no.	OEM no.	Pag.
T76831	944 350 3839	76	T83054	658 357 0901	108	T88631	389 262 2437	246
T76831	944 350 3439	76	T83195	355 353 2662	274	T88631	389 262 3137-OLD	246
T76851	944 350 2739	77	T83369	013 997 4947	158	T88695	346 350 0654	61
T76992	970 350 0240	83	T83369	011 997 6847	158	T88695	346 586 0134	61
T77180	010 997 6046	156	T83369	010 997 5346	158	T88695	346 350 0454	61
T77183	010 997 6246	156	T83369	010 997 3746	158	T91057	346 353 2262	272
T77457	1530 0420 610	156	T83439	TAS83439	85	T91058	TAS20182/S	106
T77457	000 430 3895	156	T84060	004 540 7481	277	T91093	TAS91093	97
T77457	000 430 5495	156	T84061	002 540 3997	276	T91095	TAS91095	96
T78237	TAS78237	275	T84072	947 260 0545 MO	246	T91097	948 350 0023R	66
T79635	945 268 0746/KIT	180	T84072	947 260 2845 MO	246	T91098	948 350 0123R	84
T80902	TAS80902	197	T84072	945 260 2245 MO	246	T91098	948 350 0223	84
T81023	652 350 0054/1	62	T84072	946 262 6337	246	T91947	960 262 0433	187
T81510	TAS81510	40	T84213	945 268 0746/1	40	T93476	004 981 2125	32
T81537	019 981 6105	262	T84214	945 268 0746	40	T93476	002 981 8925	32
T81537	002 981 7781	262	T84214	945 260 0073	40	T93518	TAS93518	74
T81537	002 981 5280	262	T84239	001 980 6902	258	T93522	TAS93522	237
T81544	005 981 8505	255	T84239	001 981 0005	258	T93523	TAS93523	238
T81544	386 981 0105	255	T84239	005 981 2405	258	T93524	TAS93524	238
T81544	014 981 3205	255	T84239	005 981 2505	258	T93525	TAS93525	238
T81544	006 981 0105	255	T84239	000 981 6005	258	T93577	002 992 1501	37
T81544	005 981 8405	255	T84240	007 981 5305	256	T93584	003 460 5080	125
T81546	005 981 9905	266	T84363	942 356 0715	282	T93584	002 460 0880	125
T81546	386 981 0005	266	T84363	942 356 0315	282	T93584	003 460 1980	125
T81546	005 981 8605	266	T84486	002 260 6157	276	T93584	002460 088080	125
T81546	005 981 8305	266	T84758	002 980 9502	178	T93584	002 460 3980	125
T81546	001 980 6702	266	T85315	346 350 7433A	64	T93709	001 295 6707	57
T81936	947 262 2635	230	T85345	944 350 0623	65	T93813	945 260 0197	175
T81936	947 262 1435	230	T85440	014 981 6310	142	T93819	TAS93819	210
T81936	947 262 1335	230	T85440	000 981 5111	142	T93831	005 420 0720	107
T81944	945 264 0008	107	T85476	006888 003011	134	T93831	005 420 4320	107
T81950	945 264 0009	108	T85487	1324 302 016	128	T93831	005 420 4920	107
T82129	946 350 0145	116	T85628	018 981 6805	262	T93831	005 420 5120	107
T82143	013 997 9447	157	T86080	TAS86080	95	T93831	005 420 8120	107
T82143	013 997 9347	157	T88628	389 262 0537	245	T93840	000 423 0230	107
T82143	013 997 6547	157	T88628	389 262 0037	245	T93840	003 420 5120	107
T82143	020 997 3947	157	T88628	389 262 0137	245	T93840	004 420 4420	107
T82146	017 997 2847	160	T88628	945 260 0850 MO	245	T93840	005 420 7920	107
T82165	346 353 2251	201	T88629	947 260 3045 MO	245	T93840	005 420 9320	107
T82166	346 353 1451	201	T88629	947 260 0945 MO	245	T93880	TAS93880	105
T82414	343 254 0216	56	T88630	389 262 0737	246	T93886	906 350 1523	82
T82414	343 254 0016	56	T88630	389 262 1137	246	T93887	906 350 2323	82
T82728	TAS82728	180	T88630	389 262 1437	246	T93900	TAS93900	239
T82730	TAS82730	238	T88630	389 262 2737	246	T93901	TAS93901	239
T82756	947 262 4202	129	T88630	389 262 3237-OLD	246	T94032	970 260 1944	29
T82756	974 262 1302	129	T88631	389 262 0637	246	T94033	TAS94033	107
T82756	947 262 1302	129	T88631	389 262 2537	246	T94111	007 981 0305	256
T82758	930 263 1310	16	T88631	389 262 1337	246	T94111	004 981 0605	256



<b>TAS no.</b>	<b>OEM no.</b>	<b>Pag.</b>	<b>TAS no.</b>	<b>OEM no.</b>	<b>Pag.</b>	<b>TAS no.</b>	<b>OEM no.</b>	<b>Pag.</b>
T94111	003 981 6805	256						
T94207	912009 035100	279						
T94208	000988 036100	203						
T94209	655 254 0206/PIVOT	169						
T94210	910105 012026	191						
T94237	TAS94237	41						
T94241	000 430 3568	180						
T94330	656 262 1010	45						
T94331	656 262 1334	215						
T94331	656 262 0734	215						
T94334	656 262 7982	133						
T94336	656 262 0910	24						
T94344	656 262 0023	246						
T94344	656 262 1123	246						
T94346	656 262 0117	16						
T94346	656 262 0917	16						
T94348	656 262 0705	135						
T94349	656 262 0212	14						
T94350	656 262 1035	228						
T94350	656 262 0735	228						
T94352	656 262 0111	11						
T94354	656 262 0823	247						
T94354	656 262 0523	247						
T94354	656 262 0323	247						
T94358	656 263 0810	49						
T94358	656 263 0610	49						
T94360	656 263 0410	22						
T94367	656 262 0235	228						
T94579	930 262 1005	139						
T94582	960 263 0010	120						
T94584	960 263 0002	50						



**GEARBOX AND DIFFERENTIAL**  
SPARE PARTS





**GEARBOX AND DIFFERENTIAL  
SPARE PARTS**

**Head Office**

Via Argine, 306  
80147 Napoli, Italy  
Tel.: +39 081 7520645  
Fax: +39 081 7529475

**Production unit**

Via dell'Industria, 1  
40050 Argelato (BO), Italy  
Tel.: +39 051 758154  
Fax: +39 051 732707

email: [web@tas-spa.com](mailto:web@tas-spa.com)



[www.tas-spa.com](http://www.tas-spa.com)

