



# GEARBOX AND DIFFERENTIAL SPARE PARTS



Gearbox and Differential  
spare parts suitable to:

# ZF

## IMAGE CATALOGUE





**GEARBOX AND DIFFERENTIAL**  
SPARE PARTS



## GEARBOX AND DIFFERENTIAL SPARE PARTS

T.A.S. is specialised in the manufacture and sale of **replacement spare parts** for the Automotive Aftermarket, such as bull gears, crown wheel and pinion sets (with straight and helical teeth), synchroniser assemblies with molybdenum or carbon coating, shafts, main drive gears and other components, suitable for **transmissions and differentials of light-duty vehicles, trucks, buses, agricultural tractors and earthmoving machinery.**

T.A.S. products are **totally interchangeable** with genuine parts from Mercedes, ZF, Renault Trucks, MAN, DAF, IVECO, Volvo, Dana, Scania, Meritor, Fuller Transmissions, Caterpillar, and many others, as they are made to the same high quality standards, thanks to modern technologies and to the continual specialisation of its staff.





Opening a TAS pack, you'll be astonished by its **explosive** content.

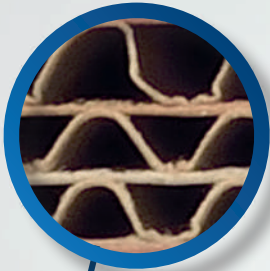

Tri-Wall corrugated cardboard box



Hardwood pallet compliant with IPPC ISPM 15





Our packaging is designed to ensure the **originality** and **integrity** of the product.



Tubular protective polyethylene nets

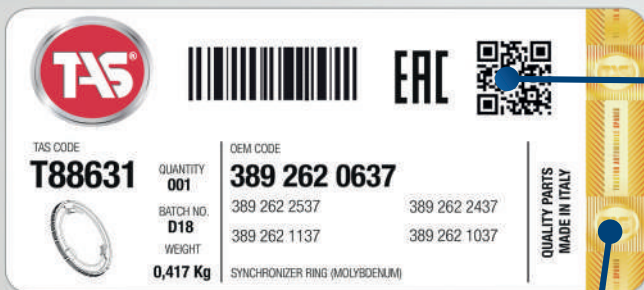

VCI Paper Sheets to prevent the onset of corrosion

**TAS**

TAS CODE: **T88631**

QUANTITY: **001**

BATCH NO.: **D18**

WEIGHT: **0,417 Kg**

OEM CODE: **389 262 0637**

389 262 2537      389 262 2437

389 262 1137      389 262 1037

ERAC

QUALITY PARTS  
MADE IN ITALY

SYNCHRONIZER RING (MOLYBDENUM)



Use your mobile phone to read the QR code that you find on the label.



You'll be directed to additional information on the TAS website.



SECURITY FOIL  
Moving DynaKey  
up and down  
"OK" is readable.



High-security OVD stripe for a reliable authentication of the product



Certifications

ZERTIFIKAT ♦ CERTIFICATE ♦ 認證證書 ♦ CERTIFICATO ♦ CERTIFICAT



## CERTIFICATO

Nr 50 100 12205 - Rev. 01  
Si attesta che / This is to certify that

IL SISTEMA QUALITÀ DI  
THE QUALITY SYSTEM OF



**T.A.S. (TRACTOR AUTOMOBILE SPARES) S.p.A.**

SEDE LEGALE E OPERATIVA:  
REGISTERED OFFICE AND OPERATIONAL SITE:  
**VIA ARGINE 306 I-80147 NAPOLI (NA)**

SEDE OPERATIVA:  
OPERATIONAL SITE:  
**VIA DELL'INDUSTRIA 1 I-40050 ARGELATO (BO)**

È CONFORME AI REQUISITI DELLA NORMA  
HAS BEEN FOUND TO COMPLY WITH THE REQUIREMENTS OF  
**UNI EN ISO 9001:2015**

QUESTO CERTIFICATO È VALIDO PER IL SEGUENTE CAMPO DI APPLICAZIONE  
THIS CERTIFICATE IS VALID FOR THE FOLLOWING SCOPE:

**Progettazione e fabbricazione di ingranaggi e organi di trasmissione per il settore automotive. Commercializzazione di componenti meccaniche nel settore automotive (IAF 18, 22, 29)**

**Design and manufacture of gears and transmission components for the automotive industry. Trade of mechanical components for the automotive industry (IAF 18, 22, 29)**

	Per l'Organismo di Certificazione For the Certification Body <b>TUV Italia S.r.l.</b>	Validità / Validity Del / From: <b>2016-11-10</b> Al / To: <b>2019-10-20</b>
	 <b>Andrea Cocca</b> <small>Chief Quality Management Officer</small>	Data emissione / Printing Date <b>2016-11-10</b>

**PRIMA CERTIFICAZIONE / FIRST CERTIFICATION: 2013-10-21**

\* LA VALIDITÀ DEL PRESENTE CERTIFICATO È SUBORDINATA A SUPERVISORIA PERIODICA A 12 MESI E IL RINNOVO COMPLETO DEL SISTEMA DI GESTIONE QUALITÀ CON PROCEDURA TRASCINATA.  
\* THE VALIDITY OF THE PRESENT CERTIFICATE DEPENDS ON THE ANNUAL SUPERVISORY VISITS AND ON THE COMPLETE REVIEW OF COMPANY'S MANAGEMENT SYSTEM AFTER TWELVE MONTHS.

TUV Italia S.r.l. • Gruppo TÜV SÜD • Via Carducci 125, Pal. 23 • 20089 Sesto San Giovanni (MI) • Italia • www.tuv.it



**ТАМОЖЕННЫЙ СОЮЗ**

**СЕРТИФИКАТ СООТВЕТСТВИЯ**

№ ТС **RU C-IT.A658.B.00936**  
Серия RU № **0478352**

**ОРГАН ПО СЕРТИФИКАЦИИ**  
Орган по сертификации продукции «И-ОНС»: Общество с ограниченной ответственностью «Агентство по экспертизе и испытаниям продукции», Адрес: 125187, РОССИЯ, город Москва, улица Вятковская, дом 16, строение 1, Флагманский адрес: 125319, РОССИЯ, город Москва, проспект Ленинградский, дом 84, строение 2, помещения № 501 на, 501 иб, 507 и, 510 на, 510 иб, 514 и, Телефон: +74957501658, Факс: +74957501658, E-mail: info@imfnd.org  
Аттестат аккредитации № RA.RU.11.A558 от 07.04.2016 года, выдан Федеральной службой по аккредитации.

**ЗАЯВИТЕЛЬ**  
Общество с ограниченной ответственностью «Центр испытаний и экспертиз продукции (представитель T.A.S. S.p.A. на основании договора на выполнение функций изготовителя), 41250, Россия, Московская область, город Ивантеевка, Сахаровский проезд, дом 1, СТФч. 1.08533603143, телефон: +74957644599, факс: +74957644599, e-mail: ciper@inbox.ru

**ИЗГОТОВИТЕЛЬ**  
T.A.S. S.p.A.  
Via Argine 306, 80147 Napoli, Италия (смотри приложение на бланке № 0301433)

**ПРОДУКЦИЯ**  
Уплотнительные головки блока цилиндров, коллекторы, газобаллонной аппаратуры, уплотнительные кольца (смотри приложение на бланке №№ 0301434, 0301435), продукция изготовлена в соответствии с ТР ТС 019/2011 "О безопасности колесных транспортных средств".  
Серийный выпуск



**КОД ТН ВЭД ТС**  
848420000, 848490000

**СООТВЕТСТВУЕТ ТРЕБОВАНИЯМ**  
ТР ТС 019/2011 "О безопасности колесных транспортных средств"

**СЕРТИФИКАТ ВЫДАН НА ОСНОВАНИИ**  
— протокола испытаний № 16/7940X от 11.07.2016 испытательной лаборатории "СМ-ТЕСТ" (аттестат аккредитации № РОСС RU.0001.21MP23, срок действия по 16.09.2016).

**ДОПОЛНИТЕЛЬНАЯ ИНФОРМАЦИЯ**  
сроки службы и условия хранения продукции согласно документации изготовителя

Срок действия с **21.12.2016** по **20.12.2020** **ВКЛЮЧИТЕЛЬНО**

 Изготовитель (уполномоченное лицо) органа по сертификации Эксперт (экспертиза-аудитор) (эксперты (эксперты-аудиторы))	 <b>А.М. Иванов</b> <small>(подпись, печать)</small>	 <b>В.В. Галевский</b> <small>(подпись, печать)</small>
---	---	--



**TAS available catalogues**  
for the following production line

**MERCEDES**

*Full parts catalogue*



**VOLVO**

*Full parts catalogue*



**SCANIA**

*Full parts catalogue*



**ZF**

*Full parts catalogue*



**U.S. LINES**

*Full parts catalogue*





**GEARBOX AND DIFFERENTIAL**  
SPARE PARTS





**Description:**  
1ST SPEED GEAR

**Packaging Unit:** 1

**OEM No :**  
1358 304 238

**Model:**  
12 TX 2420 TD (1358 001 042)  
12 TX 2420 TD (1358 001 043)  
12 TX 2420 TD (1358 001 046)  
12 TX 2420 TD (1358 001 047)  
12 TX 2420 TD (1358 001 048)  
12 TX 2421 TD IT (1358 040 038)  
12 TX 2421 TD IT (1358 040 057)  
12 TX 2421 TD IT (1358 040 058)  
12 TX 2421 TD IT (1358 040 060)  
12 TX 2620 TD IT (1358 001 041/057)  
12 TX 2620 TD IT (1358 001 055/096)  
12 TX 2620 TD IT (1358 001 056/070)  
12 TX 2620 TD IT (1358 001 066)  
12 TX 2620 TD IT (1358 001 068/155)  
12 TX 2620 TD IT (1358 001 071)  
12 TX 2620 TD IT (1358 001 770)

**EX / CROSS :**



**Description:**  
1ST SPEED GEAR

**Packaging Unit:** 1

**OEM No :**  
1329 304 007

**Model:**  
12AS 2140TD  
12AS 2340TD  
12AS 2341TD IT  
12AS 2540TD  
12AS 2540TO  
12AS 2541TD IT  
12AS 2541TO IT  
12AS 2740TO  
12AS 2741TO IT  
12AS 2940TO  
12AS 2941TO IT  
12AS 3000TD  
12AS 3000TO  
12AS 3000TO IT  
12AS 3001  
12AS 3001IT  
12AS 3140TO  
12AS 3141TO IT

**EX / CROSS :**



**Description:**  
1ST SPEED GEAR (33T.)

**Packaging Unit:** 1

**OEM No :**  
1324 304 030

**Model:**  
9S 1110TD  
9S 1110TO  
9S 1111TD IT  
9S 1111TO IT  
9S 1115TD  
9S 1115TO  
9S 1310TO  
9S 1311TO IT  
9S 1315TO

**EX / CROSS :**  
1324 304 001



**Description:**  
1ST SPEED GEAR (38T.)

**Packaging Unit:** 1

**OEM No :**  
1304 304 586

**Model:**  
8S 180  
8S 2100  
8S 2100BD  
8S 2101BD IT

**EX / CROSS :**



**Description:**  
1ST SPEED GEAR (39T.)

**Packaging Unit:** 1

**OEM No :**  
1290 304 572

**Model:**  
6S 700BO  
6S 700BO KAVZ  
6S 850  
6S 850 DAF  
6S 850 MAN  
6S 890

**EX / CROSS :**







<p><b>T11776</b></p> 	<p><b>Description:</b> 1ST SPEED GEAR (41-22T.)</p> <p><b>Packaging Unit:</b> 1</p> <p><b>OEM No :</b> 1292 304 045</p> <p><b>Model:</b></p> <p><b>EX / CROSS :</b> 1292 304 036</p>
<p><b>T14790</b></p> 	<p><b>Description:</b> 1ST SPEED GEAR (43-22T.)</p> <p><b>Packaging Unit:</b> 1</p> <p><b>OEM No :</b> 1272 304 079</p> <p><b>Model:</b></p> <p><b>EX / CROSS :</b> 1272 304 060</p>
<p><b>T19293</b></p> 	<p><b>Description:</b> 1ST SPEED GEAR (44-22T.)</p> <p><b>Packaging Unit:</b> 1</p> <p><b>OEM No :</b> 1297 304 151</p> <p><b>Model:</b> 16K 160</p> <p><b>EX / CROSS :</b></p>
<p><b>T20496</b></p> 	<p><b>Description:</b> 1ST SPEED GEAR (44-30T.)</p> <p><b>Packaging Unit:</b> 1</p> <p><b>OEM No :</b> 1316 304 013</p> <p><b>Model:</b> 16S 221 16S 221 DAF 16S 221 MB Ecosplit III</p> <p><b>EX / CROSS :</b></p>
<p><b>T15736</b></p> 	<p><b>Description:</b> 1ST SPEED GEAR (44-58T.)</p> <p><b>Packaging Unit:</b> 1</p> <p><b>OEM No :</b> 1297 304 270</p> <p><b>Model:</b></p> <p><b>EX / CROSS :</b> 1297 304 153</p>



<p><b>T18326</b></p> 	<p><b>Description:</b> 1ST SPEED GEAR (47-22T.)</p> <p><b>OEM No :</b> 1297 304 150</p> <p><b>EX / CROSS :</b></p>	<p><b>Packaging Unit:</b> 1</p> <p><b>Model:</b></p>																								
<p><b>T19401</b></p> 	<p><b>Description:</b> 1ST SPEED GEAR (47-30T.)</p> <p><b>OEM No :</b> 1316 304 010</p> <p><b>EX / CROSS :</b></p>	<p><b>Packaging Unit:</b> 1</p> <p><b>Model:</b></p> <table border="0"> <tr> <td>16S 1685</td> <td>16S 1930TD</td> </tr> <tr> <td>16S 181</td> <td>16S 1931TD IT</td> </tr> <tr> <td>16S 181 IVE</td> <td>16S 1933TD</td> </tr> <tr> <td>16S 181 MAN</td> <td>16S 1935TD</td> </tr> <tr> <td>16S 181 RVI</td> <td>16S 1937TD IT</td> </tr> <tr> <td>16S 181IT DAF</td> <td>16S 221</td> </tr> <tr> <td>16S 182</td> <td>16S 221 IVE</td> </tr> <tr> <td>16S 1920TD</td> <td>16S 221 MAN</td> </tr> <tr> <td>16S 1921TD IT</td> <td>16S 221 RVI</td> </tr> <tr> <td>16S 1922TD</td> <td>16S 221 VW</td> </tr> <tr> <td>16S 1923TD</td> <td>16S 221IT IVE</td> </tr> <tr> <td>16S 1925TD</td> <td>16S 221IT RVI</td> </tr> </table>	16S 1685	16S 1930TD	16S 181	16S 1931TD IT	16S 181 IVE	16S 1933TD	16S 181 MAN	16S 1935TD	16S 181 RVI	16S 1937TD IT	16S 181IT DAF	16S 221	16S 182	16S 221 IVE	16S 1920TD	16S 221 MAN	16S 1921TD IT	16S 221 RVI	16S 1922TD	16S 221 VW	16S 1923TD	16S 221IT IVE	16S 1925TD	16S 221IT RVI
16S 1685	16S 1930TD																									
16S 181	16S 1931TD IT																									
16S 181 IVE	16S 1933TD																									
16S 181 MAN	16S 1935TD																									
16S 181 RVI	16S 1937TD IT																									
16S 181IT DAF	16S 221																									
16S 182	16S 221 IVE																									
16S 1920TD	16S 221 MAN																									
16S 1921TD IT	16S 221 RVI																									
16S 1922TD	16S 221 VW																									
16S 1923TD	16S 221IT IVE																									
16S 1925TD	16S 221IT RVI																									
<p><b>T19536</b></p> 	<p><b>Description:</b> 1ST SPEED GEAR (47-30T.)</p> <p><b>OEM No :</b> 1315 304 004</p> <p><b>EX / CROSS :</b></p>	<p><b>Packaging Unit:</b> 1</p> <p><b>Model:</b></p> <table border="0"> <tr> <td>16S 151</td> <td>16S 1625TD</td> </tr> <tr> <td>16S 151 DAF</td> <td>16S 162TD IT</td> </tr> <tr> <td>16S 151 HYU</td> <td>16S 1630TD</td> </tr> <tr> <td>16S 151 IVE</td> <td>16S 1631TD IT</td> </tr> <tr> <td>16S 151 KMZ</td> <td>16S 1635TD</td> </tr> <tr> <td>16S 151 MAN</td> <td>16S 163TD IT</td> </tr> <tr> <td>16S 151 RVI</td> <td>16S 1820TO</td> </tr> <tr> <td>16S 151 SNVI</td> <td>16S 1820TO KMZ</td> </tr> <tr> <td>16S 151IT DAF</td> <td>16S 1820TO RVI</td> </tr> <tr> <td>16S 151PTO HIN</td> <td>16S 1821TO IT</td> </tr> <tr> <td>16S 1620TD</td> <td>16S 1822TO</td> </tr> <tr> <td>16S 1621TD IT</td> <td>16S 1823TO</td> </tr> </table>	16S 151	16S 1625TD	16S 151 DAF	16S 162TD IT	16S 151 HYU	16S 1630TD	16S 151 IVE	16S 1631TD IT	16S 151 KMZ	16S 1635TD	16S 151 MAN	16S 163TD IT	16S 151 RVI	16S 1820TO	16S 151 SNVI	16S 1820TO KMZ	16S 151IT DAF	16S 1820TO RVI	16S 151PTO HIN	16S 1821TO IT	16S 1620TD	16S 1822TO	16S 1621TD IT	16S 1823TO
16S 151	16S 1625TD																									
16S 151 DAF	16S 162TD IT																									
16S 151 HYU	16S 1630TD																									
16S 151 IVE	16S 1631TD IT																									
16S 151 KMZ	16S 1635TD																									
16S 151 MAN	16S 163TD IT																									
16S 151 RVI	16S 1820TO																									
16S 151 SNVI	16S 1820TO KMZ																									
16S 151IT DAF	16S 1820TO RVI																									
16S 151PTO HIN	16S 1821TO IT																									
16S 1620TD	16S 1822TO																									
16S 1621TD IT	16S 1823TO																									
<p><b>T23690</b></p> 	<p><b>Description:</b> 1ST SPEED GEAR (47-46T.)</p> <p><b>OEM No :</b> 1307 304 653</p> <p><b>EX / CROSS :</b> 1307 204 306 1307 204 270</p>	<p><b>Packaging Unit:</b> 1</p> <p><b>Model:</b></p> <table border="0"> <tr> <td>5S 600BO</td> </tr> <tr> <td>S5 42</td> </tr> <tr> <td>S5 42 KAVZ</td> </tr> </table>	5S 600BO	S5 42	S5 42 KAVZ																					
5S 600BO																										
S5 42																										
S5 42 KAVZ																										
<p><b>T15719</b></p> 	<p><b>Description:</b> 1ST SPEED GEAR (47-58T.)</p> <p><b>OEM No :</b> 1295 304 202</p> <p><b>EX / CROSS :</b></p>	<p><b>Packaging Unit:</b> 1</p> <p><b>Model:</b></p>																								



<p><b>T18889</b></p> 	<p><b>Description:</b> 1ST SPEED GEAR (47-58T.)</p> <p><b>Packaging Unit:</b> 1</p> <p><b>OEM No :</b> 1297 304 441</p> <p><b>Model:</b></p> <p><b>EX / CROSS :</b> 1297 304 152 1297 304 262</p>
<p><b>T44693</b></p> 	<p><b>Description:</b> 1ST SPEED GEAR (47T.)</p> <p><b>Packaging Unit:</b> 1</p> <p><b>OEM No :</b> 0091 304 297</p> <p><b>Model:</b> 16S 1650 16S 1650 MAZ</p> <p><b>EX / CROSS :</b> 0091 304 190</p>
<p><b>T23699</b></p> 	<p><b>Description:</b> 1ST SPEED GEAR (48T.)</p> <p><b>Packaging Unit:</b> 1</p> <p><b>OEM No :</b> 1307 304 652</p> <p><b>Model:</b> S5 42 S5 42 KMZ S5 42 MAZ S5 42 SNVI</p> <p><b>EX / CROSS :</b> 1307 204 274 1307 204 307</p>
<p><b>T08558</b></p> 	<p><b>Description:</b> 1ST SPEED GEAR (50-27T.)</p> <p><b>Packaging Unit:</b> 1</p> <p><b>OEM No :</b> 1250 304 240</p> <p><b>Model:</b></p> <p><b>EX / CROSS :</b> 1250 304 028 1250 304 503</p>
<p><b>T08494</b></p> 	<p><b>Description:</b> 1ST SPEED GEAR (51-27T.)</p> <p><b>Packaging Unit:</b> 1</p> <p><b>OEM No :</b> 1268 304 256</p> <p><b>Model:</b></p> <p><b>EX / CROSS :</b> 1268 304 001 1268 304 227</p>



**Description:** 1ST SPEED GEAR (51-27T.) **Packaging Unit:** 1

**OEM No :** 1268 304 213 **Model:**

**EX / CROSS :** 1268 204 003  
1268 204 006  
1268 204 018  
1268 304 159



**Description:** 1ST-2ND SPEED GEAR CNTRSHFT (18-23T.) **Packaging Unit:** 1

**OEM No :** 1324 303 017 **Model:** 9S 1110TD  
9S 1110TO  
9S 1111TD IT  
9S 1111TO IT  
9S 1115TD  
9S 1115TO  
9S 1310TO  
9S 1310TO KMZ  
9S 1311TO IT  
9S 1315TO

**EX / CROSS :** 1324 303 015



**Description:** 1ST-2ND SPEED GEAR CNTRSHFT (19-23T.) **Packaging Unit:** 1

**OEM No :** 1304 303 292 **Model:** 8S 180  
8S 2100  
8S 2100BO  
8S 2101BO IT

**EX / CROSS :**



**Description:** 1ST-2ND SPEED GEAR CNTRSHFT (19-23T.) **Packaging Unit:** 1

**OEM No :** 1272 303 026 **Model:**

**EX / CROSS :**



**Description:** 2ND SPEED GEAR **Packaging Unit:** 1

**OEM No :** 1358 304 222 **Model:** 12 TX 2420 TD (1358 001 042) 12 TX 2620 TD IT (1358 001 041/057)  
12 TX 2420 TD (1358 001 043) 12 TX 2620 TD IT (1358 001 055/096)  
12 TX 2420 TD (1358 001 046) 12 TX 2620 TD IT (1358 001 056/070)  
12 TX 2420 TD (1358 001 047) 12 TX 2620 TD IT (1358 001 066)  
12 TX 2420 TD (1358 001 048) 12 TX 2620 TD IT (1358 001 068/155)  
12 TX 2421 TD IT (1358 040 038) 12 TX 2620 TD IT (1358 001 071)  
12 TX 2421 TD IT (1358 040 057) 12 TX 2620 TD IT (1358 001 060)  
12 TX 2421 TD IT (1358 040 058) 12 TX 2620 TD IT (1358 001 071)  
12 TX 2421 TD IT (1358 040 060)

<p><b>T81644</b></p> 	<p><b>Description:</b> 2ND SPEED GEAR</p> <p><b>OEM No :</b> 1329 304 010</p> <p><b>EX / CROSS :</b></p>	<p><b>Packaging Unit:</b> 1</p> <p><b>Model:</b> 12AS 2140TD 12AS 2340TD 12AS 2341TD IT 12AS 2540TD 12AS 2540TO 12AS 2541TD IT 12AS 2541TO IT 12AS 2740TO 12AS 2741TO IT 12AS 2940TO 12AS 2941TO IT 12AS 3000TD 12AS 3000TO IT 12AS 3000TO IT 12AS 3001 12AS 3001IT 12AS 3140TO 12AS 3141TO IT</p>
<p><b>T77628</b></p> 	<p><b>Description:</b> 2ND SPEED GEAR (29T.)</p> <p><b>OEM No :</b> 1304 304 582</p> <p><b>EX / CROSS :</b></p>	<p><b>Packaging Unit:</b> 1</p> <p><b>Model:</b> 8S 180 8S 2100 8S 2100BO 8S 2101BO IT</p>
<p><b>T20717</b></p> 	<p><b>Description:</b> 2ND SPEED GEAR (30-48T.)</p> <p><b>OEM No :</b> 1324 304 015</p> <p><b>EX / CROSS :</b></p>	<p><b>Packaging Unit:</b> 1</p> <p><b>Model:</b> 9S 1110TD 9S 1110TO 9S 1111TD IT 9S 1111TO IT 9S 1115TD 9S 1115TO 9S 1310TO 9S 1310TO KMZ 9S 1311TO IT 9S 1315TO</p>
<p><b>T77095</b></p> 	<p><b>Description:</b> 2ND SPEED GEAR (34T.)</p> <p><b>OEM No :</b> 1346 304 054</p> <p><b>EX / CROSS :</b> 1346 304 011</p>	<p><b>Packaging Unit:</b> 1</p> <p><b>Model:</b> 6AS 1000TO 6AS 1005TO 6AS 1010 BO 6AS 1110BO 6S 1000TO 6S 1005TO 6S 1010BO AS Tronic</p>
<p><b>T08570</b></p> 	<p><b>Description:</b> 2ND SPEED GEAR (36-27T.)</p> <p><b>OEM No :</b> 1250 304 029</p> <p><b>EX / CROSS :</b> 1250 304 501</p>	<p><b>Packaging Unit:</b> 1</p> <p><b>Model:</b></p>



T19476



**Description:**  
2ND SPEED GEAR (37-22T.)

**Packaging Unit:** 1

**OEM No :**  
1297 304 113

**Model:**  
16K 160

**EX / CROSS :**

T20488



**Description:**  
2ND SPEED GEAR (37-30T.)

**Packaging Unit:** 1

**OEM No :**  
1316 304 003

**Model:**  
16S 221  
16S 221 DAF  
16S 221 MB  
Ecosplit III

**EX / CROSS :**

T15724



**Description:**  
2ND SPEED GEAR (37-58T.)

**Packaging Unit:** 1

**OEM No :**  
1297 304 269

**Model:**

**EX / CROSS :**  
1297 304 016

T23710



**Description:**  
2ND SPEED GEAR (37T.)

**Packaging Unit:** 1

**OEM No :**  
1307 304 632

**Model:**  
S5 42  
S5 42 KMZ  
S5 42 MAZ  
S5 42 SNVI

**EX / CROSS :**  
1307 204 273  
1307 204 304

T14780



**Description:**  
2ND SPEED GEAR (38-22T.)

**Packaging Unit:** 1

**OEM No :**  
1272 304 080

**Model:**

**EX / CROSS :**  
1272 304 070



<p><b>T09769</b></p> 	<p><b>Description:</b> 2ND SPEED GEAR (38-22T.)</p> <p><b>OEM No :</b> 1297 304 112</p> <p><b>EX / CROSS :</b></p>	<p><b>Packaging Unit:</b> 1</p> <p><b>Model:</b></p>																								
<p><b>T19160</b></p> 	<p><b>Description:</b> 2ND SPEED GEAR (38-30T.)</p> <p><b>OEM No :</b> 1316 304 002</p> <p><b>EX / CROSS :</b></p>	<p><b>Packaging Unit:</b> 1</p> <p><b>Model:</b></p> <table border="0"> <tr> <td>16S 1685</td> <td>16S 1930TD</td> </tr> <tr> <td>16S 181</td> <td>16S 1931TD IT</td> </tr> <tr> <td>16S 181 IVE</td> <td>16S 1933TD</td> </tr> <tr> <td>16S 181 MAN</td> <td>16S 1935TD</td> </tr> <tr> <td>16S 181 RVI</td> <td>16S 1937TD IT</td> </tr> <tr> <td>16S 181IT DAF</td> <td>16S 221</td> </tr> <tr> <td>16S 182</td> <td>16S 221 IVE</td> </tr> <tr> <td>16S 1920TD</td> <td>16S 221 MAN</td> </tr> <tr> <td>16S 1921TD IT</td> <td>16S 221 RVI</td> </tr> <tr> <td>16S 1922TD</td> <td>16S 221 VW</td> </tr> <tr> <td>16S 1923TD</td> <td>16S 221IT IVE</td> </tr> <tr> <td>16S 1925TD</td> <td>16S 221IT RVI</td> </tr> </table>	16S 1685	16S 1930TD	16S 181	16S 1931TD IT	16S 181 IVE	16S 1933TD	16S 181 MAN	16S 1935TD	16S 181 RVI	16S 1937TD IT	16S 181IT DAF	16S 221	16S 182	16S 221 IVE	16S 1920TD	16S 221 MAN	16S 1921TD IT	16S 221 RVI	16S 1922TD	16S 221 VW	16S 1923TD	16S 221IT IVE	16S 1925TD	16S 221IT RVI
16S 1685	16S 1930TD																									
16S 181	16S 1931TD IT																									
16S 181 IVE	16S 1933TD																									
16S 181 MAN	16S 1935TD																									
16S 181 RVI	16S 1937TD IT																									
16S 181IT DAF	16S 221																									
16S 182	16S 221 IVE																									
16S 1920TD	16S 221 MAN																									
16S 1921TD IT	16S 221 RVI																									
16S 1922TD	16S 221 VW																									
16S 1923TD	16S 221IT IVE																									
16S 1925TD	16S 221IT RVI																									
<p><b>T19184</b></p> 	<p><b>Description:</b> 2ND SPEED GEAR (38-30T.)</p> <p><b>OEM No :</b> 1315 304 025</p> <p><b>EX / CROSS :</b></p>	<p><b>Packaging Unit:</b> 1</p> <p><b>Model:</b></p> <table border="0"> <tr> <td>16S 151</td> <td>16S 1625TD</td> </tr> <tr> <td>16S 151 DAF</td> <td>16S 162TD IT</td> </tr> <tr> <td>16S 151 HYU</td> <td>16S 1630TD</td> </tr> <tr> <td>16S 151 IVE</td> <td>16S 1631TD IT</td> </tr> <tr> <td>16S 151 KMZ</td> <td>16S 1635TD</td> </tr> <tr> <td>16S 151 MAN</td> <td>16S 1637TD IT</td> </tr> <tr> <td>16S 151 RVI</td> <td>16S 1820TO</td> </tr> <tr> <td>16S 151 SNVI</td> <td>16S 1820TO KMZ</td> </tr> <tr> <td>16S 151IT DAF</td> <td>16S 1820TO RVI</td> </tr> <tr> <td>16S 151PTO HIN</td> <td>16S 1821TO IT</td> </tr> <tr> <td>16S 1620TD</td> <td>16S 1822TO</td> </tr> <tr> <td>16S 1621TD IT</td> <td>16S 1823TO</td> </tr> </table>	16S 151	16S 1625TD	16S 151 DAF	16S 162TD IT	16S 151 HYU	16S 1630TD	16S 151 IVE	16S 1631TD IT	16S 151 KMZ	16S 1635TD	16S 151 MAN	16S 1637TD IT	16S 151 RVI	16S 1820TO	16S 151 SNVI	16S 1820TO KMZ	16S 151IT DAF	16S 1820TO RVI	16S 151PTO HIN	16S 1821TO IT	16S 1620TD	16S 1822TO	16S 1621TD IT	16S 1823TO
16S 151	16S 1625TD																									
16S 151 DAF	16S 162TD IT																									
16S 151 HYU	16S 1630TD																									
16S 151 IVE	16S 1631TD IT																									
16S 151 KMZ	16S 1635TD																									
16S 151 MAN	16S 1637TD IT																									
16S 151 RVI	16S 1820TO																									
16S 151 SNVI	16S 1820TO KMZ																									
16S 151IT DAF	16S 1820TO RVI																									
16S 151PTO HIN	16S 1821TO IT																									
16S 1620TD	16S 1822TO																									
16S 1621TD IT	16S 1823TO																									
<p><b>T18313</b></p> 	<p><b>Description:</b> 2ND SPEED GEAR (38-58T.)</p> <p><b>OEM No :</b> 1297 304 442</p> <p><b>EX / CROSS :</b> 1297 304 017 1297 304 263</p>	<p><b>Packaging Unit:</b> 1</p> <p><b>Model:</b></p>																								
<p><b>T15708</b></p> 	<p><b>Description:</b> 2ND SPEED GEAR (38-58T.)</p> <p><b>OEM No :</b> 1295 304 121</p> <p><b>EX / CROSS :</b></p>	<p><b>Packaging Unit:</b> 1</p> <p><b>Model:</b></p>																								





T53401



**Description:**  
2ND SPEED GEAR (38T.)

**Packaging Unit:** 1

**OEM No :**  
0091 304 322

**Model:**  
16S 1650

**EX / CROSS :**  
0091 304 191  
0091 304 372  
0769 186 213

T08875



**Description:**  
2ND SPEED GEAR (42-22T.)

**Packaging Unit:** 1

**OEM No :**  
1269 304 132

**Model:**

**EX / CROSS :**  
1269 304 021

T08481



**Description:**  
2ND SPEED GEAR (42-27T.)

**Packaging Unit:** 1

**OEM No :**  
1268 304 204

**Model:**

**EX / CROSS :**  
1268 304 002  
1268 304 291

T23670



**Description:**  
2ND SPEED GEAR (42T.)

**Packaging Unit:** 1

**OEM No :**  
1307 304 633

**Model:**  
5S 600BO  
S5 42  
S5 42 KAVZ

**EX / CROSS :**  
1307 204 271  
1307 204 303

T08504



**Description:**  
2ND SPEED GEAR (43-22T.)

**Packaging Unit:** 1

**OEM No :**  
1272 304 132

**Model:**

**EX / CROSS :**



<p><b>T77053</b></p>	<p><b>Description:</b> 2ND SPEED GEAR (48T.)</p> <p><b>Packaging Unit:</b> 1</p> <p><b>OEM No :</b> 1327 304 024</p> <p><b>EX / CROSS :</b> 1327 304 002 1327 304 037</p> <p><b>Model:</b> 10AS 2010B IT 10AS 2300BO 10AS 2310B 10AS 2310B IT 10AS 2700BO 12AS 1601BO IT 12AS 1630TD 12AS 1631TD IT 12AS 1930TD 12AS 1930TO 12AS 1931TD IT 12AS 1931TO IT 12AS 1935TD 12AS 2000B IT 12AS 2000BO 12AS 2001BO IT 12AS 2130TD 12AS 2130TO 12AS 2131TD IT 12AS 2131TO IT 12AS 2300B IT 12AS 2300BO 12AS 2301 12AS 2301BO IT</p>
<p><b>T08898</b></p>	<p><b>Description:</b> 2ND-3RD SPEED GEAR CNTRSHFT (20-24T.)</p> <p><b>Packaging Unit:</b> 1</p> <p><b>OEM No :</b> 1269 303 006</p> <p><b>EX / CROSS :</b></p> <p><b>Model:</b></p>
<p><b>T08522</b></p>	<p><b>Description:</b> 2ND-3RD SPEED GEAR CNTRSHFT (20-26T.)</p> <p><b>Packaging Unit:</b> 1</p> <p><b>OEM No :</b> 1272 303 041</p> <p><b>EX / CROSS :</b></p> <p><b>Model:</b></p>
<p><b>T08909</b></p>	<p><b>Description:</b> 2ND-3RD SPEED GEAR CNTRSHFT (20-26T.)</p> <p><b>Packaging Unit:</b> 1</p> <p><b>OEM No :</b> 1292 303 006</p> <p><b>EX / CROSS :</b></p> <p><b>Model:</b></p>
<p><b>T53398</b></p>	<p><b>Description:</b> 3RD SPEED GEAR</p> <p><b>Packaging Unit:</b> 1</p> <p><b>OEM No :</b> 0091 304 317</p> <p><b>EX / CROSS :</b> 0091 304 192</p> <p><b>Model:</b> 16S 1650</p>



<p><b>T59004</b></p> 	<p><b>Description:</b> 3RD SPEED GEAR (24T.)</p> <p><b>OEM No :</b> 1304 304 637</p> <p><b>EX / CROSS :</b></p> <p><b>Model:</b> 8S 180 8S 2100 8S 2100BO 8S 2101BO IT</p>	<p><b>Packaging Unit:</b> 1</p>
<p><b>T23668</b></p> 	<p><b>Description:</b> 3RD SPEED GEAR (25-48T.)</p> <p><b>OEM No :</b> 1290 304 581</p> <p><b>EX / CROSS :</b> 1290 304 510 1290 304 477</p> <p><b>Model:</b> 6S 700BO 6S 850 6S 850 DAF 6S 890</p>	<p><b>Packaging Unit:</b> 1</p>
<p><b>T74498</b></p> 	<p><b>Description:</b> 3RD SPEED GEAR (27T.)</p> <p><b>OEM No :</b> 1324 304 009</p> <p><b>EX / CROSS :</b></p> <p><b>Model:</b> 9S 1110TD 9S 1111TD IT 9S 1115TD</p>	<p><b>Packaging Unit:</b> 1</p>
<p><b>T46573</b></p> 	<p><b>Description:</b> 3RD SPEED GEAR (28T.)</p> <p><b>OEM No :</b> 0091 303 106</p> <p><b>EX / CROSS :</b></p> <p><b>Model:</b> 16S 1650 16S 1650 IVE</p>	<p><b>Packaging Unit:</b> 1</p>
<p><b>T60218</b></p> 	<p><b>Description:</b> 3RD SPEED GEAR (29T.)</p> <p><b>OEM No :</b> 1346 304 136</p> <p><b>EX / CROSS :</b> 1346 304 102</p> <p><b>Model:</b> 6AS 1000TO 6AS 1005TO 6AS 1010 BO 6AS 1110BO 6S 1000TO 6S 1005TO 6S 1010BO AS Tronic</p>	<p><b>Packaging Unit:</b> 1</p>



T59019



**Description:**  
3RD SPEED GEAR (29T.)

**Packaging Unit:** 1

**OEM No :**  
1304 304 636

**Model:**  
8S 180  
8S 2100  
8S 2100BD  
8S 2101BD IT

**EX / CROSS :**

T15642



**Description:**  
3RD SPEED GEAR (30-68T.)

**Packaging Unit:** 1

**OEM No :**  
1308 304 064

**Model:**

**EX / CROSS :**

T23732



**Description:**  
3RD SPEED GEAR (30T.)

**Packaging Unit:** 1

**OEM No :**  
1307 304 638

**Model:**  
S5 42  
S5 42 KMZ  
S5 42 MAZ  
S5 42 SNVI

**EX / CROSS :**  
1307 204 316

T23721



**Description:**  
3RD SPEED GEAR (31-41T.)

**Packaging Unit:** 1

**OEM No :**  
1307 304 640

**Model:**  
5S 600BO  
S5 42  
S5 42 KAVZ

**EX / CROSS :**  
1307 204 343

T08575



**Description:**  
3RD SPEED GEAR (32-22T.)

**Packaging Unit:** 1

**OEM No :**  
1250 304 179

**Model:**

**EX / CROSS :**  
1250 304 008



<p><b>T18264</b></p> 	<p><b>Description:</b> 3RD SPEED GEAR (32-30T.)</p> <p><b>OEM No :</b> 1315 304 028</p> <p><b>EX / CROSS :</b></p>	<p><b>Packaging Unit:</b> 1</p> <p><b>Model:</b> 16S 151 16S 151 HIN Ecosplit III</p>
<p><b>T20492</b></p> 	<p><b>Description:</b> 3RD SPEED GEAR (32-30T.)</p> <p><b>OEM No :</b> 1316 304 009</p> <p><b>EX / CROSS :</b></p>	<p><b>Packaging Unit:</b> 1</p> <p><b>Model:</b> 16S 221 16S 221 DAF 16S 221 MB Ecosplit III</p>
<p><b>T15731</b></p> 	<p><b>Description:</b> 3RD SPEED GEAR (32-58T.)</p> <p><b>OEM No :</b> 1295 304 127</p> <p><b>EX / CROSS :</b></p>	<p><b>Packaging Unit:</b> 1</p> <p><b>Model:</b></p>
<p><b>T15727</b></p> 	<p><b>Description:</b> 3RD SPEED GEAR (32-58T.)</p> <p><b>OEM No :</b> 1297 304 266</p> <p><b>EX / CROSS :</b> 1297 304 019</p>	<p><b>Packaging Unit:</b> 1</p> <p><b>Model:</b></p>
<p><b>T08453</b></p> 	<p><b>Description:</b> 3RD SPEED GEAR (34-22T.)</p> <p><b>OEM No :</b> 1268 304 009</p> <p><b>EX / CROSS :</b> 1268 304 288</p>	<p><b>Packaging Unit:</b> 1</p> <p><b>Model:</b></p>

<p><b>T09775</b></p> 	<p><b>Description:</b> 3RD SPEED GEAR (34-23T.)</p> <p><b>OEM No :</b> 1297 304 115</p> <p><b>EX / CROSS :</b></p>	<p><b>Packaging Unit:</b> 1</p> <p><b>Model:</b></p>																								
<p><b>T18062</b></p> 	<p><b>Description:</b> 3RD SPEED GEAR (34-30T.)</p> <p><b>OEM No :</b> 1315 304 027</p> <p><b>EX / CROSS :</b></p>	<p><b>Packaging Unit:</b> 1</p> <p><b>Model:</b></p> <table border="0"> <tr> <td>16S 151</td> <td>16S 1625TD</td> </tr> <tr> <td>16S 151 DAF</td> <td>16S 162TD IT</td> </tr> <tr> <td>16S 151 HYU</td> <td>16S 1630TD</td> </tr> <tr> <td>16S 151 IVE</td> <td>16S 1631TD IT</td> </tr> <tr> <td>16S 151 KMZ</td> <td>16S 1635TD</td> </tr> <tr> <td>16S 151 MAN</td> <td>16S 163TD IT</td> </tr> <tr> <td>16S 151 RVI</td> <td>16S 1820TO</td> </tr> <tr> <td>16S 151 SNVI</td> <td>16S 1820TO KMZ</td> </tr> <tr> <td>16S 151IT DAF</td> <td>16S 1820TO RVI</td> </tr> <tr> <td>16S 151PTO HIN</td> <td>16S 1821TO IT</td> </tr> <tr> <td>16S 1620TD</td> <td>16S 1822TO</td> </tr> <tr> <td>16S 1621TD IT</td> <td>16S 1823TO</td> </tr> </table>	16S 151	16S 1625TD	16S 151 DAF	16S 162TD IT	16S 151 HYU	16S 1630TD	16S 151 IVE	16S 1631TD IT	16S 151 KMZ	16S 1635TD	16S 151 MAN	16S 163TD IT	16S 151 RVI	16S 1820TO	16S 151 SNVI	16S 1820TO KMZ	16S 151IT DAF	16S 1820TO RVI	16S 151PTO HIN	16S 1821TO IT	16S 1620TD	16S 1822TO	16S 1621TD IT	16S 1823TO
16S 151	16S 1625TD																									
16S 151 DAF	16S 162TD IT																									
16S 151 HYU	16S 1630TD																									
16S 151 IVE	16S 1631TD IT																									
16S 151 KMZ	16S 1635TD																									
16S 151 MAN	16S 163TD IT																									
16S 151 RVI	16S 1820TO																									
16S 151 SNVI	16S 1820TO KMZ																									
16S 151IT DAF	16S 1820TO RVI																									
16S 151PTO HIN	16S 1821TO IT																									
16S 1620TD	16S 1822TO																									
16S 1621TD IT	16S 1823TO																									
<p><b>T19166</b></p> 	<p><b>Description:</b> 3RD SPEED GEAR (34-30T.)</p> <p><b>OEM No :</b> 1316 304 094</p> <p><b>EX / CROSS :</b></p>	<p><b>Packaging Unit:</b> 1</p> <p><b>Model:</b></p> <table border="0"> <tr> <td>16S 1685</td> </tr> <tr> <td>16S 181</td> </tr> <tr> <td>16S 181 IVE</td> </tr> <tr> <td>16S 181 MAN</td> </tr> <tr> <td>16S 181 RVI</td> </tr> <tr> <td>16S 181IT DAF</td> </tr> <tr> <td>16S 182</td> </tr> <tr> <td>Ecosplit III</td> </tr> </table>	16S 1685	16S 181	16S 181 IVE	16S 181 MAN	16S 181 RVI	16S 181IT DAF	16S 182	Ecosplit III																
16S 1685																										
16S 181																										
16S 181 IVE																										
16S 181 MAN																										
16S 181 RVI																										
16S 181IT DAF																										
16S 182																										
Ecosplit III																										
<p><b>T19061</b></p> 	<p><b>Description:</b> 3RD SPEED GEAR (34-30T.)</p> <p><b>OEM No :</b> 1316 304 008</p> <p><b>EX / CROSS :</b></p>	<p><b>Packaging Unit:</b> 1</p> <p><b>Model:</b></p> <table border="0"> <tr> <td>16S 1920TD</td> <td>16S 221 MAN</td> </tr> <tr> <td>16S 1921TD IT</td> <td>16S 221 RVI</td> </tr> <tr> <td>16S 1922TD</td> <td>16S 221 VW</td> </tr> <tr> <td>16S 1923TD</td> <td>16S 221IT IVE</td> </tr> <tr> <td>16S 1925TD</td> <td>16S 221IT RVI</td> </tr> <tr> <td>16S 1930TD</td> <td>16S 2220TD</td> </tr> <tr> <td>16S 1931TD IT</td> <td>16S 2220TO</td> </tr> <tr> <td>16S 1933TD</td> <td>16S 2220TO IT</td> </tr> <tr> <td>16S 1935TD</td> <td>16S 2220TO IVE</td> </tr> <tr> <td>16S 193TD IT</td> <td>16S 2221TD IT</td> </tr> <tr> <td>16S 221</td> <td>16S 2221TO IT</td> </tr> <tr> <td>16S 221 IVE</td> <td>16S 2222TD</td> </tr> </table>	16S 1920TD	16S 221 MAN	16S 1921TD IT	16S 221 RVI	16S 1922TD	16S 221 VW	16S 1923TD	16S 221IT IVE	16S 1925TD	16S 221IT RVI	16S 1930TD	16S 2220TD	16S 1931TD IT	16S 2220TO	16S 1933TD	16S 2220TO IT	16S 1935TD	16S 2220TO IVE	16S 193TD IT	16S 2221TD IT	16S 221	16S 2221TO IT	16S 221 IVE	16S 2222TD
16S 1920TD	16S 221 MAN																									
16S 1921TD IT	16S 221 RVI																									
16S 1922TD	16S 221 VW																									
16S 1923TD	16S 221IT IVE																									
16S 1925TD	16S 221IT RVI																									
16S 1930TD	16S 2220TD																									
16S 1931TD IT	16S 2220TO																									
16S 1933TD	16S 2220TO IT																									
16S 1935TD	16S 2220TO IVE																									
16S 193TD IT	16S 2221TD IT																									
16S 221	16S 2221TO IT																									
16S 221 IVE	16S 2222TD																									
<p><b>T18328</b></p> 	<p><b>Description:</b> 3RD SPEED GEAR (34-58T.)</p> <p><b>OEM No :</b> 1297 304 261</p> <p><b>EX / CROSS :</b> 1297 304 020</p>	<p><b>Packaging Unit:</b> 1</p> <p><b>Model:</b></p>																								



T11156



**Description:**  
3RD SPEED GEAR (34-58T.)

**Packaging Unit:** 1

**OEM No :**  
1296 304 087

**Model:**

**EX / CROSS :**

T11158



**Description:**  
3RD SPEED GEAR (34-58T.)

**Packaging Unit:** 1

**OEM No :**  
1295 304 128

**Model:**

**EX / CROSS :**

T73149



**Description:**  
3RD SPEED GEAR (34T.)

**Packaging Unit:** 1

**OEM No :**  
1310 304 186

**Model:**  
6S 1350 BO  
6S 1700BO  
6S 1701BO IT  
6S 1900BO  
6S 1901BO IT

**EX / CROSS :**

T59014



**Description:**  
3RD SPEED GEAR (34T.)

**Packaging Unit:** 1

**OEM No :**  
1304 303 293

**Model:**  
8S 180  
8S 2100  
8S 2100BO  
8S 2101BO IT

**EX / CROSS :**

T09048



**Description:**  
3RD SPEED GEAR (35-22T.)

**Packaging Unit:** 1

**OEM No :**  
1268 304 252

**Model:**  
S6 90  
S6 90/1

**EX / CROSS :**



**T08454**



**Description:**  
3RD SPEED GEAR (35-22T.)

**Packaging Unit:** 1

**OEM No :**  
1268 304 003

**Model:**

**EX / CROSS :**  
1268 304 285

**T38458**



**Description:**  
3RD SPEED GEAR (35T.)

**Packaging Unit:** 1

**OEM No :**  
1310 304 112

**Model:**  
6S 1000BO  
6S 1200BO  
6S 1200BO IKA  
6S 1200BO KMZ  
6S 1200TO  
S6 85  
S6 85 LIAZ  
S6 85 MAN  
S6 85 NEFAZ

**EX / CROSS :**  
1310 304 085

**T41820**



**Description:**  
3RD SPEED GEAR (35T.)

**Packaging Unit:** 1

**OEM No :**  
0091 304 369

**Model:**  
16S 1650

**EX / CROSS :**

**T20359**



**Description:**  
3RD SPEED GEAR (36-18T.)

**Packaging Unit:** 1

**OEM No :**  
1269 304 130

**Model:**

**EX / CROSS :**  
1269 304 022

**T08894**



**Description:**  
3RD SPEED GEAR (37-19T.)

**Packaging Unit:** 1

**OEM No :**  
1272 304 134

**Model:**

**EX / CROSS :**





T08852



**Description:**  
3RD SPEED GEAR (37-22T.)

**Packaging Unit:** 1

**OEM No :**  
1269 304 131

**Model:**

**EX / CROSS :**  
1269 304 006

T08879



**Description:**  
3RD SPEED GEAR (38-22T.)

**Packaging Unit:** 1

**OEM No :**  
1292 304 046

**Model:**

**EX / CROSS :**

T08887



**Description:**  
3RD SPEED GEAR (40-22T.)

**Packaging Unit:** 1

**OEM No :**  
1272 304 131

**Model:**

**EX / CROSS :**

T74170



**Description:**  
3RD SPEED GEAR CNTRSHFT (20T.)

**Packaging Unit:** 1

**OEM No :**  
1290 303 213

**Model:**  
6S 850

**EX / CROSS :**

T22601



**Description:**  
3RD SPEED GEAR CNTRSHFT (22T.)

**Packaging Unit:** 1

**OEM No :**  
1290 303 197

**Model:**  
6S 700BO  
6S 700BO KAVZ  
6S 850  
6S 890

**EX / CROSS :**



**T77256**



**Description:**

3RD SPEED GEAR CNTRSHFT (24T.)

**Packaging Unit: 1**

**OEM No :**

1310 303 072

**Model:**

6S 1350 BO  
6S 1700BO  
6S 1701BO IT

**EX / CROSS :**

1310 303 065

1310 303 078

**T38983**



**Description:**

3RD SPEED GEAR CNTRSHFT (24T.)

**Packaging Unit: 1**

**OEM No :**

1310 303 031

**Model:**

6S 1000BO  
6S 1200BO  
6S 1200BO IKA  
6S 1200BO KMZ  
6S 1200TO  
S6 85  
S6 85 LIAZ  
S6 85 MAN  
S6 85 NEFAZ

**EX / CROSS :**

**T44688**



**Description:**

3RD SPEED GEAR CNTRSHFT (25T.)

**Packaging Unit: 1**

**OEM No :**

0091 303 137

**Model:**

16S 1650  
16S 1650 MAZ

**EX / CROSS :**

0091 303 093

**T09789**



**Description:**

3RD SPEED GEAR CNTRSHFT (25T.)

**Packaging Unit: 1**

**OEM No :**

1297 303 067

**Model:**

**EX / CROSS :**

1297 303 009

**T19288**



**Description:**

3RD SPEED GEAR CNTRSHFT (25T.)

**Packaging Unit: 1**

**OEM No :**

1297 303 077

**Model:**

16K 160  
16K 190

**EX / CROSS :**

1297 303 021

1297 303 022



**T09783**



**Description:**

3RD SPEED GEAR CNTRSHFT (25T.)

**Packaging Unit: 1**

**OEM No :**

1295 303 026

**Model:**

**EX / CROSS :**

1295 303 105

**T11163**



**Description:**

3RD SPEED GEAR CNTRSHFT (25T.)

**Packaging Unit: 1**

**OEM No :**

1296 303 009

**Model:**

**EX / CROSS :**

**T19041**



**Description:**

3RD SPEED GEAR CNTRSHFT (26T.)

**Packaging Unit: 1**

**OEM No :**

1316 303 040

**Model:**

16S 1920TD  
16S 1921TD IT  
16S 1922TD  
16S 1923TD  
16S 1925TD  
16S 1930TD  
16S 1931TD IT  
16S 1933TD  
16S 1935TD  
16S 193TD IT  
16S 221  
16S 221 IVE

16S 221 MAN  
16S 221 RVI  
16S 221 VW  
16S 221IT IVE  
16S 221IT RVI  
16S 2220TD  
16S 2220TO  
16S 2220TO IT  
16S 2220TO IVE  
16S 2221TD IT  
16S 2221TO IT  
16S 2222TD

**EX / CROSS :**

1316 303 005

**T19150**



**Description:**

3RD SPEED GEAR CNTRSHFT (26T.)

**Packaging Unit: 1**

**OEM No :**

1316 303 058

**Model:**

16S 1685  
16S 181  
16S 181 IVE  
16S 181 MAN  
16S 181 RVI  
16S 181IT DAF  
16S 182  
Ecosplit III

**EX / CROSS :**

**T19975**



**Description:**

3RD SPEED GEAR CNTRSHFT (26T.)

**Packaging Unit: 1**

**OEM No :**

1297 303 132



**Model:**

16S 160  
16S 160/1  
16S 160A  
16S 190  
16S 190/1  
16S 190A  
16S 190A/1

**EX / CROSS :**

1297 303 042

1297 303 085

<p><b>T19178</b></p> 	<p><b>Description:</b> 3RD SPEED GEAR CNTRSHFT (26T.)</p> <p><b>Packaging Unit:</b> 1</p> <p><b>OEM No :</b> 1315 303 004</p> <p><b>Model:</b> 16S 151 16S 151 DAF 16S 151 HYU 16S 151 IVE 16S 151 KMZ 16S 151 MAN 16S 151 RVI 16S 151 SNVI 16S 151IT DAF 16S 151PTO HIN 16S 1620TD 16S 1621TD IT</p> <p><b>EX / CROSS :</b></p> <p>16S 1625TD 16S 162TD IT 16S 1630TD 16S 1631TD IT 16S 1635TD 16S 163TD IT 16S 1820TO 16S 1820TO KMZ 16S 1820TO RVI 16S 1821TO IT 16S 1822TO 16S 1823TO</p>
<p><b>T77191</b></p> 	<p><b>Description:</b> 3RD SPEED GEAR CNTRSHFT (26T.)</p> <p><b>Packaging Unit:</b> 1</p> <p><b>OEM No :</b> 1346 303 046</p> <p><b>Model:</b> 6AS 1000TO 6AS 1005TO 6AS 1010 BO 6AS 1110BO 6S 1000TO 6S 1005TO 6S 1010BO AS Tronic</p> <p><b>EX / CROSS :</b> 1346 303 029</p>
<p><b>T20515</b></p> 	<p><b>Description:</b> 3RD SPEED GEAR CNTRSHFT (28T.)</p> <p><b>Packaging Unit:</b> 1</p> <p><b>OEM No :</b> 1315 303 010</p> <p><b>Model:</b> 16S 151 16S 151 HIN Ecosplit III</p> <p><b>EX / CROSS :</b></p>
<p><b>T15755</b></p> 	<p><b>Description:</b> 3RD SPEED GEAR CNTRSHFT (28T.)</p> <p><b>Packaging Unit:</b> 1</p> <p><b>OEM No :</b> 1297 303 073</p> <p><b>Model:</b></p> <p><b>EX / CROSS :</b> 1297 303 010</p>
<p><b>T19393</b></p> 	<p><b>Description:</b> 3RD SPEED GEAR CNTRSHFT (28T.)</p> <p><b>Packaging Unit:</b> 1</p> <p><b>OEM No :</b> 1316 303 006</p> <p><b>Model:</b> 16S 221 16S 221 DAF 16S 221 MB Ecosplit III</p> <p><b>EX / CROSS :</b></p>



T74495



**Description:**

3RD SPEED GEAR CNTRSHFT (28T.)

**Packaging Unit:** 1

**OEM No :**

1324 303 018

**Model:**

9S 1110TD  
9S 1111TD IT  
9S 1115TD

**EX / CROSS :**

1324 303 008

T19986



**Description:**

3RD SPEED GEAR CNTRSHFT (28T.)

**Packaging Unit:** 1

**OEM No :**

1295 303 025

**Model:**

16S 130  
16S 130/1

**EX / CROSS :**

T23798



**Description:**

3RD SPEED GEAR CNTRSHFT (30T.)

**Packaging Unit:** 1

**OEM No :**

1307 303 116

**Model:**

5S 600BO  
S5 42  
S5 42 KAVZ

**EX / CROSS :**

1307 303 059

T23789



**Description:**

3RD SPEED GEAR CNTRSHFT (31T.)

**Packaging Unit:** 1

**OEM No :**

1307 395 318

**Model:**

S5 42  
S5 42 KMZ  
S5 42 MAZ  
S5 42 SNVI

**EX / CROSS :**

1317 303 012

1307 303 110

T80182



**Description:**

3RD SPEED GEAR CNTRSHFT (32T.)

**Packaging Unit:** 1

**OEM No :**

1308 303 027

**Model:**

9S 75

**EX / CROSS :**



T09044



**Description:**

3RD-4TH SPEED GEAR CNTRSHFT (21-27T.)

**Packaging Unit:** 1

**OEM No :**  
1268 303 097

**Model:**  
S6 90  
S6 90/1  
S6 90/1+GV90

**EX / CROSS :**

T08340



**Description:**

3RD-4TH SPEED GEAR CNTRSHFT (22-27T.)

**Packaging Unit:** 1

**OEM No :**  
1250 303 062

**Model:**

**EX / CROSS :**

1250 303 075  
1250 303 038

T15446



**Description:**

3RD-4TH SPEED GEAR CNTRSHFT (22-28T.)

**Packaging Unit:** 1

**OEM No :**  
1250 303 084

**Model:**

**EX / CROSS :**

T08508



**Description:**

3RD-4TH SPEED GEAR CNTRSHFT (23-28T.)

**Packaging Unit:** 1

**OEM No :**  
1268 303 005

**Model:**

**EX / CROSS :**

T08507



**Description:**

3RD-4TH SPEED GEAR CNTRSHFT (23-33T.)

**Packaging Unit:** 1

**OEM No :**  
1268 303 006

**Model:**

**EX / CROSS :**



T19481



**Description:**

4TH SPEED GEAR (23-28-58T.)

**Packaging Unit:** 1

**OEM No :**

1297 304 128

**Model:**

16K 160

**EX / CROSS :**

T09767



**Description:**

4TH SPEED GEAR (23-30-58T.)

**Packaging Unit:** 1

**OEM No :**

1297 304 127

**Model:**

**EX / CROSS :**

T22558



**Description:**

4TH SPEED GEAR (23T.)

**Packaging Unit:** 1

**OEM No :**

1290 304 574

**Model:**

6S 700BO  
6S 700BO KAVZ  
6S 850  
6S 850 DAF  
6S 850 MAN  
6S 890

**EX / CROSS :**

1290 304 546

1290 304 480

T08585



**Description:**

4TH SPEED GEAR (26-22T.)

**Packaging Unit:** 1

**OEM No :**

1250 304 217

**Model:**

**EX / CROSS :**

1250 304 052

T08576



**Description:**

4TH SPEED GEAR (26-22T.)

**Packaging Unit:** 1

**OEM No :**





1250 304 178

**Model:**

**EX / CROSS :**

1250 304 070



<p><b>T20713</b></p> 	<p><b>Description:</b> 4TH SPEED GEAR (27-48T.)</p> <p><b>OEM No :</b> 1324 304 003</p> <p><b>EX / CROSS :</b></p> <p><b>Model:</b> 9S 1110TO 9S 1111TO IT 9S 1115TO 9S 1310TO 9S 1310TO KMZ 9S 1311TO IT 9S 1315TO</p>	<p><b>Packaging Unit:</b> 1</p>
<p><b>T77091</b></p> 	<p><b>Description:</b> 4TH SPEED GEAR (27T.)</p> <p><b>OEM No :</b> 1346 304 099</p> <p><b>EX / CROSS :</b></p> <p><b>Model:</b> 6AS 1000TO 6AS 1005TO 6AS 1010 BO 6AS 1110BO 6S 1000TO 6S 1005TO 6S 1010BO AS Tronic</p>	<p><b>Packaging Unit:</b> 1</p>
<p><b>T73138</b></p> 	<p><b>Description:</b> 4TH SPEED GEAR (28T.)</p> <p><b>OEM No :</b> 1310 304 178</p> <p><b>EX / CROSS :</b></p> <p><b>Model:</b> 6S 1350 BO 6S 1700BO 6S 1701BO IT 6S 1900BO 6S 1901BO IT</p>	<p><b>Packaging Unit:</b> 1</p>
<p><b>T08455</b></p> 	<p><b>Description:</b> 4TH SPEED GEAR (29-22T.)</p> <p><b>OEM No :</b> 1268 304 004</p> <p><b>EX / CROSS :</b> 1268 304 286</p>	<p><b>Packaging Unit:</b> 1</p>
<p><b>T19232</b></p> 	<p><b>Description:</b> 4TH SPEED GEAR (29-22T.)</p> <p><b>OEM No :</b> 1268 304 237</p> <p><b>EX / CROSS :</b></p> <p><b>Model:</b> AK6 90 AK6 90+GV90</p>	<p><b>Packaging Unit:</b> 1</p>





**T38463**



**Description:**  
4TH SPEED GEAR (29T.)

**Packaging Unit:** 1

**OEM No :**  
1310 304 088

**Model:**  
6S 1000BO  
6S 1200BO  
6S 1200BO IKA  
6S 1200BO KMZ  
6S 1200TO  
S6 85  
S6 85 LIAZ  
S6 85 MAN  
S6 85 NEFAZ

**EX / CROSS :**

**T08276**



**Description:**  
4TH SPEED GEAR (30-22T.)

**Packaging Unit:** 1

**OEM No :**  
1268 304 010

**Model:**

**EX / CROSS :**  
1268 304 289

**T20022**



**Description:**  
4TH SPEED GEAR (30-30-30T.)

**Packaging Unit:** 1

**OEM No :**  
1313 304 005

**Model:**  
16S 150

**EX / CROSS :**

**T19397**



**Description:**  
4TH SPEED GEAR (30-30-30T.)

**Packaging Unit:** 1

**OEM No :**  
1316 304 007

**Model:**  
16S 221  
16S 221 DAF  
16S 221 MB  
Ecosplit III

**EX / CROSS :**

**T17807**



**Description:**  
4TH SPEED GEAR (30-30-30T.)

**Packaging Unit:** 1

**OEM No :**  
1315 304 017

**Model:**  
16S 151  
16S 151 HIN  
Ecosplit III

**EX / CROSS :**

<p><b>T17696</b></p> 	<p><b>Description:</b> 4TH SPEED GEAR (30-32-30T.)</p> <p><b>OEM No :</b> 1315 304 089</p> <p><b>EX / CROSS :</b></p>	<p><b>Packaging Unit:</b> 1</p> <p><b>Model:</b> 16S 1625TD 16S 162TD IT 16S 1630TD 16S 1631TD IT 16S 1635TD 16S 163TD IT 16S 1820TO 16S 1820TO KMZ 16S 1820TO RVI 16S 1821TO IT 16S 1822TO 16S 1823TO</p>
<p><b>T17914</b></p> 	<p><b>Description:</b> 4TH SPEED GEAR (30-32-30T.)</p> <p><b>OEM No :</b> 1316 304 103</p> <p><b>EX / CROSS :</b></p>	<p><b>Packaging Unit:</b> 1</p> <p><b>Model:</b> 16S 1685 16S 181 16S 181 IVE 16S 181 MAN 16S 181 RVI 16S 181IT DAF 16S 182 16S 1920TD 16S 1921TD IT 16S 1922TD 16S 1923TD 16S 1925TD 16S 1930TD 16S 1931TD IT 16S 1933TD 16S 1935TD 16S 193TD IT 16S 221 16S 221 IVE 16S 221 MAN 16S 221 RVI 16S 221 VW 16S 221IT IVE 16S 221IT RVI</p>
<p><b>T39343</b></p> 	<p><b>Description:</b> 4TH SPEED GEAR (30T.)</p> <p><b>OEM No :</b> 0091 304 314</p> <p><b>EX / CROSS :</b> 0091 304 193</p>	<p><b>Packaging Unit:</b> 1</p> <p><b>Model:</b> 16S 1650 16S 1650 MAZ</p>
<p><b>T09046</b></p> 	<p><b>Description:</b> 4TH SPEED GEAR (31-22T.)</p> <p><b>OEM No :</b> 1268 304 251</p> <p><b>EX / CROSS :</b></p>	<p><b>Packaging Unit:</b> 1</p> <p><b>Model:</b> S6 90 S6 90/1</p>
<p><b>T60287</b></p> 	<p><b>Description:</b> 4TH SPEED GEAR (31T.)</p> <p><b>OEM No :</b> 0091 304 054</p> <p><b>EX / CROSS :</b> 0091 304 094</p>	<p><b>Packaging Unit:</b> 1</p> <p><b>Model:</b> S6 1550</p>



T08502



**Description:**  
4TH SPEED GEAR (33-19T.)

**Packaging Unit:** 1

**OEM No :**  
1272 304 139

**Model:**

**EX / CROSS :**  
1272 304 069  
1272 304 081  
1272 304 138

T08468



**Description:**  
4TH SPEED GEAR (34-18T.)

**Packaging Unit:** 1

**OEM No :**  
1269 304 139

**Model:**

**EX / CROSS :**  
1269 304 138

T46577



**Description:**  
4TH SPEED GEAR (34T.)

**Packaging Unit:** 1

**OEM No :**  
0091 303 141

**Model:**  
16S 1650 IVE

**EX / CROSS :**  
0091 303 102  
0091 303 143

T08491



**Description:**  
4TH SPEED GEAR (35-18T.)

**Packaging Unit:** 1

**OEM No :**  
1292 304 047

**Model:**

**EX / CROSS :**

T19483



**Description:**  
4TH SPEED GEAR (58-26-58T.)

**Packaging Unit:** 1

**OEM No :**  
1297 304 318

**Model:**  
16S 160  
16S 160/1  
16S 190  
16S 190A

**EX / CROSS :**  
1297 304 175



T19111



**Description:**

4TH SPEED GEAR (58-26-58T.)

**Packaging Unit:** 1

**OEM No :**

1295 304 236

**Model:**

16S 130  
16S 130/1

**EX / CROSS :**

T15016



**Description:**

4TH SPEED GEAR (58-28-58T.)

**Packaging Unit:** 1

**OEM No :**

1297 304 267

**Model:**

**EX / CROSS :**

1297 304 025

T15713



**Description:**

4TH SPEED GEAR (58-28-58T.)

**Packaging Unit:** 1

**OEM No :**

1295 304 136

**Model:**

**EX / CROSS :**

T19530



**Description:**

4TH SPEED GEAR (58-29-58T.)

**Packaging Unit:** 1

**OEM No :**

1297 304 413

**Model:**

16S 160  
16S 160/1  
16S 160A  
16S 190  
16S 190/1  
16S 190A  
16S 190A/1

**EX / CROSS :**

1297 304 285

1297 304 123

T15019



**Description:**

4TH SPEED GEAR (58-30-58T.)

**Packaging Unit:** 1

**OEM No :**

1297 304 260

**Model:**

**EX / CROSS :**

1297 304 026



T09759



**Description:**  
4TH SPEED GEAR (58-30-58T.)

**Packaging Unit:** 1

**OEM No :**  
1295 304 135

**Model:**

**EX / CROSS :**  
1295 304 322

T11154



**Description:**  
4TH SPEED GEAR (58-30-58T.)

**Packaging Unit:** 1

**OEM No :**  
1296 304 090

**Model:**

**EX / CROSS :**

T08906



**Description:**  
4TH SPEED GEAR CNTRSHFT (27T.)

**Packaging Unit:** 1

**OEM No :**  
1272 303 027

**Model:**

**EX / CROSS :**

T77244



**Description:**  
4TH SPEED GEAR CNTRSHFT (31T.)

**Packaging Unit:** 1

**OEM No :**  
1310 303 062

**Model:**  
6S 1350 BO  
6S 1700BO  
6S 1701BO IT

**EX / CROSS :**

T15026



**Description:**  
4TH SPEED GEAR CNTRSHFT (31T.)

**Packaging Unit:** 1

**OEM No :**  
1297 303 065

**Model:**

**EX / CROSS :**  
1297 303 026



T22530



**Description:**

4TH SPEED GEAR CNTRSHFT (31T.)

**Packaging Unit:** 1

**OEM No :**

1290 303 198

**Model:**

6S 700BO  
6S 700BO KAVZ  
6S 850  
6S 850 DAF  
6S 850 MAN  
6S 890

**EX / CROSS :**

T44682



**Description:**

4TH SPEED GEAR CNTRSHFT (31T.)

**Packaging Unit:** 1

**OEM No :**

0091 303 142

**Model:**

16S 1650  
16S 1650 MAZ

**EX / CROSS :**

0091 303 094

0091 303 138

T11169



**Description:**

4TH SPEED GEAR CNTRSHFT (31T.)

**Packaging Unit:** 1

**OEM No :**

1296 303 002

**Model:**

**EX / CROSS :**

T09785



**Description:**

4TH SPEED GEAR CNTRSHFT (31T.)

**Packaging Unit:** 1

**OEM No :**

1295 303 027

**Model:**

**EX / CROSS :**

1295 303 098

1295 303 103

T38445



**Description:**

4TH SPEED GEAR CNTRSHFT (32T.)

**Packaging Unit:** 1

**OEM No :**

1310 303 051

**Model:**

6S 1000BO  
6S 1200BO  
6S 1200BO IKA  
6S 1200BO KMZ  
6S 1200TO  
S6 85  
S6 85 LIAZ  
S6 85 MAN  
S6 85 NEFAZ

**EX / CROSS :**



<p><b>T19526</b></p> 	<p><b>Description:</b> 4TH SPEED GEAR CNTRSHFT (32T.)</p> <p><b>OEM No :</b> 1297 303 123</p> <p><b>EX / CROSS :</b> 1297 303 041</p> <p><b>Model:</b> 16S 160 16S 160/1 16S 160A 16S 190 16S 190/1 16S 190A 16S 190A/1</p>	<p><b>Packaging Unit:</b> 1</p>
<p><b>T08523</b></p> 	<p><b>Description:</b> 4TH SPEED GEAR CNTRSHFT (32T.)</p> <p><b>OEM No :</b> 1272 303 042</p> <p><b>EX / CROSS :</b></p>	<p><b>Packaging Unit:</b> 1</p>
<p><b>T15047</b></p> 	<p><b>Description:</b> 4TH SPEED GEAR CNTRSHFT (34T.)</p> <p><b>OEM No :</b> 1297 303 072</p> <p><b>EX / CROSS :</b> 1297 303 025 1297 303 135</p>	<p><b>Packaging Unit:</b> 1</p>
<p><b>T19455</b></p> 	<p><b>Description:</b> 4TH SPEED GEAR CNTRSHFT (34T.)</p> <p><b>OEM No :</b> 1295 303 028</p> <p><b>EX / CROSS :</b></p>	<p><b>Packaging Unit:</b> 1</p> <p><b>Model:</b> 16K 130 16S 130 16S 130/1</p>
<p><b>T19056</b></p> 	<p><b>Description:</b> 4TH SPEED GEAR CNTRSHFT (35T.)</p> <p><b>OEM No :</b> 1316 303 065</p> <p><b>EX / CROSS :</b> 1316 303 003</p>	<p><b>Packaging Unit:</b> 1</p> <p><b>Model:</b> 16S 1685 16S 1920TD 16S 1921TD IT 16S 1922TD 16S 1923TD 16S 1925TD 16S 1930TD 16S 1931TD IT 16S 1933TD 16S 1935TD 16S 193TD IT 16S 221 16S 221 IVE 16S 221 MAN 16S 221 RVI 16S 221 VW 16S 221IT IVE 16S 221IT RVI 16S 2220TD 16S 2220TO 16S 2220TO IT 16S 2220TO IVE 16S 2221TD IT 16S 2221TO IT</p>

<p><b>T19155</b></p> 	<p><b>Description:</b> 4TH SPEED GEAR CNTRSHFT (35T.)</p> <p><b>OEM No :</b> 1316 303 063</p> <p><b>EX / CROSS :</b></p>	<p><b>Packaging Unit:</b> 1</p> <p><b>Model:</b> 16S 181 16S 181 IVE 16S 181 MAN 16S 181 RVI 16S 181IT DAF 16S 182 Ecosplit III</p>
<p><b>T18466</b></p> 	<p><b>Description:</b> 4TH SPEED GEAR CNTRSHFT (35T.)</p> <p><b>OEM No :</b> 1315 303 050</p> <p><b>EX / CROSS :</b></p>	<p><b>Packaging Unit:</b> 1</p> <p><b>Model:</b> 16S 151 16S 151 DAF 16S 151 HYU 16S 151 IVE 16S 151 KMZ 16S 151 MAN 16S 151 RVI 16S 151 SNVI 16S 151IT DAF 16S 151PTO HIN 16S 1620TD 16S 1621TD IT</p> <p>16S 1625TD 16S 162TD IT 16S 1630TD 16S 1631TD IT 16S 1635TD 16S 163TD IT 16S 1820TO 16S 1820TO KMZ 16S 1820TO RVI 16S 1821TO IT 16S 1822TO 16S 1823TO</p>
<p><b>T77186</b></p> 	<p><b>Description:</b> 4TH SPEED GEAR CNTRSHFT (37T.)</p> <p><b>OEM No :</b> 1346 303 040</p> <p><b>EX / CROSS :</b> 1346 303 007</p>	<p><b>Packaging Unit:</b> 1</p> <p><b>Model:</b> 6AS 1000TO 6AS 1005TO 6AS 1010 BO 6AS 1110BO 6S 1000TO 6S 1005TO 6S 1010BO AS Tronic</p>
<p><b>T22303</b></p> 	<p><b>Description:</b> 4TH SPEED GEAR CNTRSHFT (37T.)</p> <p><b>OEM No :</b> 1324 303 003</p> <p><b>EX / CROSS :</b></p>	<p><b>Packaging Unit:</b> 1</p> <p><b>Model:</b> 9S 1110TO 9S 1111TO IT 9S 1115TO 9S 1310TO 9S 1310TO KMZ 9S 1311TO IT 9S 1315TO</p>
<p><b>T17794</b></p> 	<p><b>Description:</b> 4TH SPEED GEAR CNTRSHFT (39T.)</p> <p><b>OEM No :</b> 1315 303 046</p> <p><b>EX / CROSS :</b> 1315 303 011</p>	<p><b>Packaging Unit:</b> 1</p> <p><b>Model:</b> 16S 151 16S 151 HIN Ecosplit III</p>





<p><b>T20010</b></p> 	<p><b>Description:</b> 4TH SPEED GEAR CNTRSHFT (39T.)</p> <p><b>Packaging Unit:</b> 1</p> <p><b>OEM No :</b> 1313 303 003</p> <p><b>Model:</b> 16S 150</p> <p><b>EX / CROSS :</b></p>
<p><b>T19548</b></p> 	<p><b>Description:</b> 4TH SPEED GEAR CNTRSHFT (39T.)</p> <p><b>Packaging Unit:</b> 1</p> <p><b>OEM No :</b> 1316 303 004</p> <p><b>Model:</b> 16S 221 16S 221 DAF 16S 221 MB Ecosplit III</p> <p><b>EX / CROSS :</b></p>
<p><b>T09548</b></p> 	<p><b>Description:</b> 4TH SPEED GEAR CNTRSHFT (41T.)</p> <p><b>Packaging Unit:</b> 1</p> <p><b>OEM No :</b> 1307 303 015</p> <p><b>Model:</b></p> <p><b>EX / CROSS :</b></p>
<p><b>T08902</b></p> 	<p><b>Description:</b> 4TH-5TH SPEED GEAR CNTRSHFT (30-41T.)</p> <p><b>Packaging Unit:</b> 1</p> <p><b>OEM No :</b> 1269 303 053</p> <p><b>Model:</b></p> <p><b>EX / CROSS :</b> 1269 303 005</p>
<p><b>T08521</b></p> 	<p><b>Description:</b> 4TH-5TH SPEED GEAR CNTRSHFT (33-41T.)</p> <p><b>Packaging Unit:</b> 1</p> <p><b>OEM No :</b> 1292 303 005</p> <p><b>Model:</b></p> <p><b>EX / CROSS :</b></p>



T08470



**Description:**  
5TH SPEED GEAR (19-19T.)

**Packaging Unit:** 1

**OEM No :**  
1250 304 384

**Model:**

**EX / CROSS :**  
1250 304 137  
1250 304 181

T08577



**Description:**  
5TH SPEED GEAR (22-19T.)

**Packaging Unit:** 1

**OEM No :**  
1250 304 127

**Model:**

**EX / CROSS :**  
1250 304 171

T73141



**Description:**  
5TH SPEED GEAR (23T.)

**Packaging Unit:** 1

**OEM No :**  
1310 304 138

**Model:**  
6S 1350 BO  
6S 1700BO  
6S 1701BO IT  
6S 1900BO  
6S 1901BO IT

**EX / CROSS :**

T37950



**Description:**  
5TH SPEED GEAR (23T.)

**Packaging Unit:** 1

**OEM No :**  
1310 304 091

**Model:**  
6S 1000BO  
6S 1200BO  
6S 1200BO IKA  
6S 1200BO KMZ  
6S 1200TO  
S6 85  
S6 85 LIAZ  
S6 85 MAN  
S6 85 NEFAZ

**EX / CROSS :**

T08586



**Description:**  
5TH SPEED GEAR (24-19T.)

**Packaging Unit:** 1

**OEM No :**  
1250 304 210

**Model:**

**EX / CROSS :**



T08458



**Description:**  
5TH SPEED GEAR (24-19T.)

**Packaging Unit:** 1

**OEM No :**  
1268 304 005

**Model:**

**EX / CROSS :**

T19236



**Description:**  
5TH SPEED GEAR (24-19T.)

**Packaging Unit:** 1

**OEM No :**  
1268 304 262

**Model:**  
AK6 90  
AK6 90+GV90

**EX / CROSS :**

T81205



**Description:**  
5TH SPEED GEAR (24T.)

**Packaging Unit:** 1

**OEM No :**  
1268 304 287

**Model:**  
S6 90+GV90

**EX / CROSS :**

T23740



**Description:**  
5TH SPEED GEAR (25T.)

**Packaging Unit:** 1

**OEM No :**  
1307 204 325

**Model:**  
5S 600BO  
S5 42  
S5 42 KAVZ

**EX / CROSS :**  
1307 204 173  
1307 204 277  
1307 204 158

T11387



**Description:**  
5TH SPEED GEAR (26-19T.)

**Packaging Unit:** 1

**OEM No :**  
1268 304 094

**Model:**  
AK6 90  
AK6 90+GV90

**EX / CROSS :**  
1268 304 011



<p><b>T22111</b></p> 	<p><b>Description:</b> 5TH SPEED GEAR (26T.)</p> <p><b>Packaging Unit:</b> 1</p> <p><b>OEM No :</b> 1307 295 235</p> <p><b>Model:</b> S5 42 KMZ S5 42 MAZ S5 42 SNVI</p> <p><b>EX / CROSS :</b> 1307 204 323 1307 204 279 1307 204 170 1307 204 043</p>
<p><b>T15484</b></p> 	<p><b>Description:</b> 5TH SPEED GEAR (27-19T.)</p> <p><b>Packaging Unit:</b> 1</p> <p><b>OEM No :</b> 1250 304 400</p> <p><b>Model:</b> S6 80 S6 80+GV80 S6 80/1+GV80</p> <p><b>EX / CROSS :</b></p>
<p><b>T11161</b></p> 	<p><b>Description:</b> 5TH SPEED GEAR (28-58T.)</p> <p><b>Packaging Unit:</b> 1</p> <p><b>OEM No :</b> 1296 302 003</p> <p><b>Model:</b></p> <p><b>EX / CROSS :</b></p>
<p><b>T14807</b></p> 	<p><b>Description:</b> 5TH SPEED GEAR (28-61T.)</p> <p><b>Packaging Unit:</b> 1</p> <p><b>OEM No :</b> 1296 302 023</p> <p><b>Model:</b></p> <p><b>EX / CROSS :</b></p>
<p><b>T08456</b></p> 	<p><b>Description:</b> 5TH SPEED GEAR (29-19T.)</p> <p><b>Packaging Unit:</b> 1</p> <p><b>OEM No :</b> 1268 304 015</p> <p><b>Model:</b></p> <p><b>EX / CROSS :</b> 1268 304 290</p>



T15438



**Description:**  
5TH SPEED GEAR (30-19T.)

**Packaging Unit:** 1

**OEM No :**  
1250 304 305

**Model:**

**EX / CROSS :**

T09050



**Description:**  
5TH SPEED GEAR (31-46T.)

**Packaging Unit:** 1

**OEM No :**  
1268 304 250

**Model:**  
S6 90  
S6 90/1

**EX / CROSS :**  
1268 304 536

T58563



**Description:**  
5TH SPEED GEAR (31T.)

**Packaging Unit:** 1

**OEM No :**  
0091 304 298

**Model:**  
S6 1550

**EX / CROSS :**  
1268 304 559

T23726



**Description:**  
5TH SPEED GEAR (57T.)

**Packaging Unit:** 1

**OEM No :**  
1317 303 015

**Model:**  
S5 42 KMZ  
S5 42 MAZ  
S5 42 SNVI  
S5 47

**EX / CROSS :**  
1307 395 322

T09799



**Description:**  
5TH SPEED GEAR CNTRSHFT (31T.)

**Packaging Unit:** 1

**OEM No :**  
1295 303 036

**Model:**  
16K 130  
16S 130  
16S 130/1

**EX / CROSS :**



<p><b>T15040</b></p> 	<p><b>Description:</b> 5TH SPEED GEAR CNTRSHFT (31T.)</p> <p><b>Packaging Unit:</b> 1</p> <p><b>OEM No :</b> 1297 303 074</p> <p><b>Model:</b></p> <p><b>EX / CROSS :</b> 1297 303 040 0091 303 174 0091 303 172</p>
<p><b>T11165</b></p> 	<p><b>Description:</b> 5TH SPEED GEAR CNTRSHFT (34T.)</p> <p><b>Packaging Unit:</b> 1</p> <p><b>OEM No :</b> 1296 303 014</p> <p><b>Model:</b></p> <p><b>EX / CROSS :</b></p>
<p><b>T15033</b></p> 	<p><b>Description:</b> 5TH SPEED GEAR CNTRSHFT (34T.)</p> <p><b>Packaging Unit:</b> 1</p> <p><b>OEM No :</b> 1297 303 066</p> <p><b>Model:</b></p> <p><b>EX / CROSS :</b> 0091 303 171 0091 303 173 1297 303 039</p>
<p><b>T09787</b></p> 	<p><b>Description:</b> 5TH SPEED GEAR CNTRSHFT (34T.)</p> <p><b>Packaging Unit:</b> 1</p> <p><b>OEM No :</b> 1295 303 101</p> <p><b>Model:</b></p> <p><b>EX / CROSS :</b> 1295 303 037 1295 303 097</p>
<p><b>T08510</b></p> 	<p><b>Description:</b> 5TH SPEED GEAR CNTRSHFT (34T.)</p> <p><b>Packaging Unit:</b> 1</p> <p><b>OEM No :</b> 1268 303 004</p> <p><b>Model:</b></p> <p><b>EX / CROSS :</b></p>



**T08588**



**Description:**

5TH SPEED GEAR CNTRSHFT (36T.)

**Packaging Unit:** 1

**OEM No :**

1250 303 074

**Model:**

**EX / CROSS :**

1250 303 073

**T15488**



**Description:**

5TH SPEED GEAR CNTRSHFT (37T.)

**Packaging Unit:** 1

**OEM No :**

1268 303 094

**Model:**

S6 90  
S6 90 SETRA  
S6 90+GV90  
S6 90/1  
S6 90/1+GV90

**EX / CROSS :**

**T08910**



**Description:**

5TH SPEED GEAR CNTRSHFT (37T.)

**Packaging Unit:** 1

**OEM No :**

1272 303 025

**Model:**

**EX / CROSS :**

**T09043**



**Description:**

5TH SPEED GEAR CNTRSHFT (39T.)

**Packaging Unit:** 1

**OEM No :**

1268 303 096

**Model:**

S6 90  
S6 90/1

**EX / CROSS :**

**T56685**



**Description:**

5TH SPEED GEAR CNTRSHFT (39T.)

**Packaging Unit:** 1

**OEM No :**

0091 303 030

**Model:**

S6 1550

**EX / CROSS :**



T77148



**Description:**

5TH SPEED GEAR CNTRSHFT (40T.)

**Packaging Unit:** 1

**OEM No :**

1346 303 038

**Model:**

6AS 1000TO  
6AS 1005TO  
6AS 1010BO  
6AS 1110BO  
6S 1000TO  
6S 1005TO  
6S 1010BO  
AS Tronic

**EX / CROSS :**

1346 303 034

T15481



**Description:**

5TH SPEED GEAR CNTRSHFT (41T.)

**Packaging Unit:** 1

**OEM No :**

1250 303 137

**Model:**

S6 80  
S6 80+GV80

**EX / CROSS :**

T08560



**Description:**

5TH SPEED GEAR CNTRSHFT (42T.)

**Packaging Unit:** 1

**OEM No :**

1250 303 058

**Model:**

**EX / CROSS :**

1250 303 027

T77231



**Description:**

5TH SPEED GEAR CNTRSHFT (43T.)

**Packaging Unit:** 1

**OEM No :**

1310 303 059

**Model:**

6S 1350 BO  
6S 1700BO  
6S 1701BO IT

**EX / CROSS :**

T15452



**Description:**

5TH SPEED GEAR CNTRSHFT (43T.)

**Packaging Unit:** 1

**OEM No :**

1250 303 094

**Model:**

**EX / CROSS :**





T23752



**Description:**

5TH SPEED GEAR CNTRSHFT (48T.)

**Packaging Unit:** 1

**OEM No :**

1317 303 016

**Model:**

5S 600BO  
S5 42  
S5 42 KAVZ  
S5 47

**EX / CROSS :**

T08509



**Description:**

5TH SPEED GEAR CNTRSHFT (59T.)

**Packaging Unit:** 1

**OEM No :**

1268 303 012

**Model:**

**EX / CROSS :**

T11386



**Description:**

5TH SPEED GEAR CNTRSHFT (61T.)

**Packaging Unit:** 1

**OEM No :**

1268 303 007

**Model:**

AK6 90  
AK6 90+GV90  
S6 90  
S6 90+GV90

**EX / CROSS :**

T22689



**Description:**

6TH SPEED GEAR (22T.)

**Packaging Unit:** 1

**OEM No :**

1290 304 547

**Model:**

6S 700BO  
6S 700BO KAVZ  
6S 850  
6S 850 MAN  
6S 890

**EX / CROSS :**

1290 304 515

T77087



**Description:**

6TH SPEED GEAR (23T.)

**Packaging Unit:** 1

**OEM No :**

1346 304 048

**Model:**

6AS 1000TO  
6AS 1005TO  
6AS 1010 BO  
6AS 1110BO  
6S 1000TO  
6S 1005TO  
6S 1010BO  
AS Tronic

**EX / CROSS :**











<p><b>T08517</b></p> 	<p><b>Description:</b> 6TH SPEED GEAR CNTRSHFT (37T.)</p> <p><b>Packaging Unit:</b> 1</p> <p><b>OEM No :</b> 1250 303 111</p> <p><b>Model:</b></p> <p><b>EX / CROSS :</b> 1250 303 021 1250 303 055</p>
<p><b>T08519</b></p> 	<p><b>Description:</b> 6TH SPEED GEAR CNTRSHFT (41T.)</p> <p><b>Packaging Unit:</b> 1</p> <p><b>OEM No :</b> 1250 303 112</p> <p><b>Model:</b></p> <p><b>EX / CROSS :</b> 1250 303 022 1250 303 054</p>
<p><b>T38441</b></p> 	<p><b>Description:</b> 6TH SPEED GEAR CNTRSHFT (45T.)</p> <p><b>Packaging Unit:</b> 1</p> <p><b>OEM No :</b> 1310 303 033</p> <p><b>Model:</b> 6S 1000BO 6S 1200BO 6S 1200BO IKA 6S 1200BO KMZ 6S 1200TO S6 85 S6 85 LIAZ S6 85 MAN S6 85 NEFAZ</p> <p><b>EX / CROSS :</b></p>
<p><b>T09042</b></p> 	<p><b>Description:</b> 6TH SPEED GEAR CNTRSHFT (46T.)</p> <p><b>Packaging Unit:</b> 1</p> <p><b>OEM No :</b> 1268 303 093</p> <p><b>Model:</b> S6 90 S6 90 SETRA S6 90+GV90 S6 90/1 S6 90/1+GV90</p> <p><b>EX / CROSS :</b></p>
<p><b>T08513</b></p> 	<p><b>Description:</b> 6TH SPEED GEAR CNTRSHFT (48T.)</p> <p><b>Packaging Unit:</b> 1</p> <p><b>OEM No :</b> 1268 303 057</p> <p><b>Model:</b></p> <p><b>EX / CROSS :</b> 1268 303 008</p>







<p><b>T22605</b></p> 	<p><b>Description:</b> 6TH SPEED GEAR CNTRSHFT (53T.)</p> <p><b>OEM No :</b> 1290 303 199</p> <p><b>EX / CROSS :</b></p>	<p><b>Packaging Unit:</b> 1</p> <p><b>Model:</b> 6S 700BO 6S 700BO KAVZ 6S 850 6S 850 MAN 6S 890</p>
<p><b>T08515</b></p> 	<p><b>Description:</b> 6TH SPEED GEAR CNTRSHFT (53T.)</p> <p><b>OEM No :</b> 1268 303 056</p> <p><b>EX / CROSS :</b> 1268 303 003</p>	<p><b>Packaging Unit:</b> 1</p> <p><b>Model:</b></p>
<p><b>T77155</b></p> 	<p><b>Description:</b> 6TH SPEED GEAR CNTRSHFT (56T.)</p> <p><b>OEM No :</b> 1346 303 039</p> <p><b>EX / CROSS :</b> 1346 303 033</p>	<p><b>Packaging Unit:</b> 1</p> <p><b>Model:</b> 6AS 1000TO 6AS 1005TO 6AS 1010 BO 6AS 1110BO 6S 1000TO 6S 1005TO 6S 1010BO AS Tronic</p>
<p><b>T09039</b></p> 	<p><b>Description:</b> BALL (Ø 6)</p> <p><b>OEM No :</b> 0635 460 010</p> <p><b>EX / CROSS :</b></p>	<p><b>Packaging Unit:</b> 3</p> <p><b>Model:</b></p>
<p><b>T56940</b></p> 	<p><b>Description:</b> BALL BEARING (100X125X13)</p> <p><b>OEM No :</b> 0635 338 035</p> <p><b>EX / CROSS :</b></p>	<p><b>Packaging Unit:</b> 1</p> <p><b>Model:</b> 16S 190 16S 190/1 16S 220 16S 220A 16S 221 16S 2520TO 16S 252TO IT 8S 221 Ecosplit III</p>

<p><b>T22337</b></p> 	<p><b>Description:</b> BALL BEARING (45X100X25)</p> <p><b>OEM No :</b> 0750 116 373</p> <p><b>EX / CROSS :</b> BB1 3167 0735 330 615</p>	<p><b>Packaging Unit:</b> 1</p> <p><b>Model:</b> 6AS 700TO 6S 700BO 6S 700BO KAVZ 6S 850 6S 850 DAF 6S 850 MAN 6S 890 AS Tronic</p>
<p><b>T19914</b></p> 	<p><b>Description:</b> BALL BEARING (45X75X16)</p> <p><b>OEM No :</b> 0750 116 233</p> <p><b>EX / CROSS :</b> 0635 331 390</p>	<p><b>Packaging Unit:</b> 1</p> <p><b>Model:</b> 12 TX 1815 TO (1372 002 035) PTO 12AS 3141TO IT 16AS 2230TD 16AS 2600TO 16AS 2630TO 16AS 2631TO IT 16AS 2635TO 16K 130 16K 160 16K 190 16S 112 16S 130 16S 130/1 16S 151 16S 151PTO HIN 16S 160 16S 160/1 16S 1635TD 16S 181 16S 190 16S 190/1 16S 221 16S 2225TO 16S 2235TD</p>
<p><b>T38058</b></p> 	<p><b>Description:</b> BALL BEARING (45X85X19)</p> <p><b>OEM No :</b> 0750 116 231</p> <p><b>EX / CROSS :</b> 6209NC3</p>	<p><b>Packaging Unit:</b> 1</p> <p><b>Model:</b> 6S 300</p>
<p><b>T55355</b></p> 	<p><b>Description:</b> BALL BEARING (55X116X28)</p> <p><b>OEM No :</b> 0750 116 374</p> <p><b>EX / CROSS :</b> 0735 330 800 0735 330 685 0735 330 614 BB1 3357</p>	<p><b>Packaging Unit:</b> 1</p> <p><b>Model:</b> 6S 700BO 6S 850 6S 890</p>
<p><b>T54549</b></p> 	<p><b>Description:</b> BALL BEARING (60X130X31)</p> <p><b>OEM No :</b> 0735 330 801</p> <p><b>EX / CROSS :</b></p>	<p><b>Packaging Unit:</b> 1</p> <p><b>Model:</b> 6AS 1000TO 6AS 1005TO 6AS 800TO 6AS 805TO 6S 1000TO 6S 1005TO 6S 1010BO 6S 800TO AS Tronic</p>

<p><b>T47446</b></p> 	<p><b>Description:</b> BALL BEARING (70X90X10)</p> <p><b>OEM No :</b> 0735 340 080</p> <p><b>EX / CROSS :</b> 61814-Y-C3</p>	<p><b>Packaging Unit:</b> 1</p> <p><b>Model:</b> 16S 109 4S 120GP 5K 90GP 5K 90GPA 5K 91GP 5S 90GP 5S 90GPA 5S 92GP 6S 150C 8S 109 8S 140 8S 180</p> <p>9S 109</p>
<p><b>T47385</b></p> 	<p><b>Description:</b> BALL BEARING (75X105X16)</p> <p><b>OEM No :</b> 0750 116 166</p> <p><b>EX / CROSS :</b> 61915-A 0635 338 048 0635 900 686</p>	<p><b>Packaging Unit:</b> 1</p> <p><b>Model:</b> 16K 130 16S 112 16S 112/1 16S 130 16S 130/1</p>
<p><b>T47553</b></p> 	<p><b>Description:</b> BALL BEARING (75X115X13)</p> <p><b>OEM No :</b> 0635 330 050</p> <p><b>EX / CROSS :</b> 16015.C3 0635 330 016</p>	<p><b>Packaging Unit:</b> 1</p> <p><b>Model:</b> 4S 150GP 4S 150GP+400 5K 110GP 5K 110GP+GV90 5K 110GPA 5K 110GPA+GV90 5S 110GP 5S 110GP+GV90 5S 110GPA 5S 110GPA+GV90 5S 111GP 5S 111GP+GV90</p> <p>5S 111GPA</p>
<p><b>T66036</b></p> 	<p><b>Description:</b> BALL BEARING (80X140X26)</p> <p><b>OEM No :</b> 0750 116 404</p> <p><b>EX / CROSS :</b> 0750 116 197</p>	<p><b>Packaging Unit:</b></p> <p><b>Model:</b> 9S 1310TO KMZ</p>
<p><b>T22220</b></p> 	<p><b>Description:</b> BALL BEARING (90X160X30)</p> <p><b>OEM No :</b> 0750 116 394</p> <p><b>EX / CROSS :</b> 539244B 0635 304 904 0735 330 043 0750 116 002</p>	<p><b>Packaging Unit:</b> 1</p> <p><b>Model:</b> 10AS 2010B IT 10AS 2300BO 10AS 2310B 10AS 2310B IT 10AS 2700BO 12 TX 1410 TD IT (1372 001 023) 12 TX 1410 TD IT (1372 001 030) 12 TX 1410 TO (1372 002 019) 12 TX 1411 TD IT (1372 040 027) 12 TX 1411 TD IT (1372 040 027)</p> <p>12 TX 1415 TD IT (1372 001 026) 12 TX 1610 TO IT (1372 002 025) 12 TX 1610 TO IT (1372 002 045) 12 TX 1611 BO IT (1372 044 006) 12 TX 1611 BO IT (1372 044 033) 12 TX 1611 BO IT (1372 044 050) 12 TX 1611 BO IT (1372 044 051)</p>

<p><b>T50736</b></p> 	<p><b>Description:</b> BALL JOINT</p> <p><b>OEM No :</b> 0732 107 019</p> <p><b>EX / CROSS :</b> 0501 206 799</p>	<p><b>Packaging Unit:</b> 1</p> <p><b>Model:</b> 16S 220A 4S 150GP 4S 150GP+400 5K 110GP 5K 110GP+GV90 5K 110GPA 5K 110GPA+GV90 5K 90GP 5K 90GPA 5K 91GP 5K 91GPA 5S 110GP</p>
<p><b>T50733</b></p> 	<p><b>Description:</b> BALL JOINT</p> <p><b>OEM No :</b> 0501 204 714</p> <p><b>EX / CROSS :</b> 0501 203 819 0732 107 001</p>	<p><b>Packaging Unit:</b> 1</p> <p><b>Model:</b> 16S 220A 4S 150GP 4S 150GP+400 5K 110GP 5K 110GP+GV90 5K 110GPA 5K 110GPA+GV90 5K 90GP 5K 90GPA 5K 91GP 5K 91GPA 5S 110GP</p>
<p><b>T50741</b></p> 	<p><b>Description:</b> BALL JOINT</p> <p><b>OEM No :</b> 0732 107 018</p> <p><b>EX / CROSS :</b> 0501 206 800 0732 107 010</p>	<p><b>Packaging Unit:</b> 1</p> <p><b>Model:</b> 16S 220A 4S 150GP 4S 150GP+400 5K 110GP 5K 110GP+GV90 5K 110GPA 5K 110GPA+GV90 5K 90GP 5K 90GPA 5K 91GP 5K 91GPA 5S 110GP</p>
<p><b>T39674</b></p> 	<p><b>Description:</b> BALL ROLLER</p> <p><b>OEM No :</b> 0501 209 188</p> <p><b>EX / CROSS :</b></p>	<p><b>Packaging Unit:</b> 2</p> <p><b>Model:</b> 16S 151 DAF 16S 151 HIN 16S 151 HYU 16S 151 IVE 16S 151 KMZ 16S 151 MAN 16S 151 RVI 16S 151 SNVI 16S 151IT DAF 16S 151PTO HIN 16S 1685 16S 181 IVE 16S 181 MAN 16S 181 RVI 16S 181IT DAF 16S 1820TO KMZ 16S 221 DAF 16S 221 IVE 16S 221 MB 16S 221 RVI 16S 221IT IVE 16S 221IT RVI 16S 2220TO IVE 16S 2280TO</p>
<p><b>T45524</b></p> 	<p><b>Description:</b> BALL ROLLER</p> <p><b>OEM No :</b> 1295 307 160</p> <p><b>EX / CROSS :</b> 0750 115 335 0501 204 318</p>	<p><b>Packaging Unit:</b> 4</p> <p><b>Model:</b> 16S 150 16S 1650 IVE 16S 1650 MAZ 8S 1350 KMZ</p>







<p><b>T57460</b></p> 	<p><b>Description:</b> BEARING (100X130X30)</p> <p><b>OEM No :</b> 0750 118 284</p> <p><b>EX / CROSS :</b></p>	<p><b>Packaging Unit:</b> 1</p> <p><b>Model:</b> 10AS 2010B IT 10AS 2300BO 10AS 2310B 10AS 2310B IT 10AS 2700BO 12 TX 1410 TD IT (1372 001 023) 12 TX 1410 TD IT (1372 001 030) 12 TX 1410 TO (1372 002 019) 12 TX 1411 TD IT (1372 040 027) 12 TX 1411 TD IT (1372 040 027)</p> <p>12 TX 1415 TD IT (1372 001 026) 12 TX 1610 TO IT (1372 002 025) 12 TX 1610 TO IT (1372 002 045) 12 TX 1611 BO IT (1372 044 006) 12 TX 1611 BO IT (1372 044 033) 12 TX 1611 BO IT (1372 044 050) 12 TX 1611 BO IT (1372 044 050)</p>
<p><b>T72906</b></p> 	<p><b>Description:</b> BRACKET</p> <p><b>OEM No :</b> 0501 209 212</p> <p><b>EX / CROSS :</b></p>	<p><b>Packaging Unit:</b> 1</p> <p><b>Model:</b> 16S 151 16S 1685 16S 181 16S 221 16S 251 8S 151 8S 221 Ecosplit III</p>
<p><b>T69843</b></p> 	<p><b>Description:</b> BRACKET</p> <p><b>OEM No :</b> 1315 207 014</p> <p><b>EX / CROSS :</b> 1315 207 011</p>	<p><b>Packaging Unit:</b> 1</p> <p><b>Model:</b></p>
<p><b>T08952</b></p> 	<p><b>Description:</b> BUSH</p> <p><b>OEM No :</b> 1250 304 142</p> <p><b>EX / CROSS :</b></p>	<p><b>Packaging Unit:</b> 1</p> <p><b>Model:</b></p>
<p><b>T08848</b></p> 	<p><b>Description:</b> BUSH</p> <p><b>OEM No :</b> 1283 304 004</p> <p><b>EX / CROSS :</b> 1283 304 026</p>	<p><b>Packaging Unit:</b> 1</p> <p><b>Model:</b></p>







<p><b>T22223</b></p> 	<p><b>Description:</b> BUSH</p> <p><b>OEM No :</b> 1324 304 070</p> <p><b>EX / CROSS :</b> 1324 304 064 1304 304 050</p>	<p><b>Packaging Unit:</b> 1</p> <p><b>Model:</b> 6S 150C 8S 140 9S 109 9S 109 MAN 9S 109 SNVI 9S 1110TD 9S 1110TO 9S 1111TD IT 9S 1111TO IT 9S 1115TD 9S 1115TO 9S 1310TO</p> <p>9S 1310TO KMZ 9S 1311TO IT 9S 1315TO</p>
<p><b>T09045</b></p> 	<p><b>Description:</b> BUSH</p> <p><b>OEM No :</b> 1268 304 141</p> <p><b>EX / CROSS :</b></p>	<p><b>Packaging Unit:</b> 1</p> <p><b>Model:</b> AK6 90 S6 90 S6 90 SETRA S6 90+GV90 S6 90/1 S6 90/1+GV90</p>
<p><b>T09810</b></p> 	<p><b>Description:</b> BUSH</p> <p><b>OEM No :</b> 0091 305 012</p> <p><b>EX / CROSS :</b> 0730 160 344 0730 160 240</p>	<p><b>Packaging Unit:</b> 1</p> <p><b>Model:</b></p>
<p><b>T38786</b></p> 	<p><b>Description:</b> BUSH</p> <p><b>OEM No :</b> 1316 333 014</p> <p><b>EX / CROSS :</b></p>	<p><b>Packaging Unit:</b> 1</p> <p><b>Model:</b> 16S 151 16S 151 DAF 16S 151 HIN 16S 151 HYU 16S 151 IVE 16S 151 KMZ 16S 151 MAN 16S 151 RVI 16S 151PTO HIN 16S 1620TD 16S 1625TD 16S 1685</p> <p>16S 181 16S 181 MAN 16S 182 16S 1820TO 16S 1820TO KMZ 16S 1820TO RVI 16S 1822TO 16S 1823TO 16S 1825TO 16S 1920TD 16S 1922TD 16S 1923TD</p>
<p><b>T20539</b></p> 	<p><b>Description:</b> BUSH</p> <p><b>OEM No :</b> 1316 304 133</p> <p><b>EX / CROSS :</b> 1312 304 082</p>	<p><b>Packaging Unit:</b> 1</p> <p><b>Model:</b> 16S 1685 16S 181 16S 181 IVE 16S 181 MAN 16S 181 RVI 16S 181IT DAF 16S 182 16S 1920TD 16S 1921TD IT 16S 1922TD 16S 1923TD 16S 1925TD</p> <p>16S 1930TD 16S 1931TD IT 16S 1933TD 16S 1935TD 16S 1937TD IT 16S 220 16S 220A 16S 221 16S 221 DAF 16S 221 IVE 16S 221 MAN 16S 221 MB</p>





<p><b>T57478</b></p> 	<p><b>Description:</b> BUSH</p> <p><b>Packaging Unit:</b> 1</p> <p><b>OEM No :</b> TAS57478</p> <p><b>Model:</b></p> <p><b>EX / CROSS :</b></p>
<p><b>T20968</b></p> 	<p><b>Description:</b> BUSH</p> <p><b>Packaging Unit:</b> 1</p> <p><b>OEM No :</b> 0750 119 125</p> <p><b>Model:</b> 16S 151 16S 151 DAF 16S 151 HIN 16S 151 HYU 16S 151 IVE 16S 151 KMZ 16S 151 MAN 16S 151 RVI 16S 151 SNVI 16S 151IT DAF 16S 151PTO HIN 16S 1620TD</p> <p><b>EX / CROSS :</b></p> <p>16S 1621TD IT 16S 1625TD 16S 162TD IT 16S 1630TD 16S 1631TD IT 16S 1635TD 16S 163TD IT 16S 1820TO 16S 1820TO KMZ 16S 1820TO RVI 16S 1821TO IT 16S 1822TO</p>
<p><b>T20963</b></p> 	<p><b>Description:</b> BUSH</p> <p><b>Packaging Unit:</b> 1</p> <p><b>OEM No :</b> 0750 119 124</p> <p><b>Model:</b> 16S 1685 16S 181 16S 181 IVE 16S 181 MAN 16S 181 RVI 16S 181IT DAF 16S 182 16S 1920TD 16S 1921TD IT 16S 1922TD 16S 1923TD 16S 1925TD</p> <p><b>EX / CROSS :</b></p> <p>16S 1930TD 16S 1931TD IT 16S 1933TD 16S 1935TD 16S 193TD IT 16S 221 16S 221 DAF 16S 221 IVE 16S 221 MAN 16S 221 MB 16S 221 RVI 16S 221IT IVE</p>
<p><b>T19927</b></p> 	<p><b>Description:</b> BUSH</p> <p><b>Packaging Unit:</b> 1</p> <p><b>OEM No :</b> 1295 338 083</p> <p><b>Model:</b> 16AS 2230TD 16AS 2600TO 16AS 2630TO 16AS 2631TO IT 16AS 2635TO 16K 130 16K 160 16K 190 16S 112 16S 130 16S 130/1 16S 151</p> <p><b>EX / CROSS :</b> 1295 338 012</p> <p>16S 151PTO HIN 16S 160 16S 160/1 16S 1635TD 16S 181 16S 190 16S 190/1 16S 221 16S 2225TO 16S 2235TD 16S 251 16S 2725TO</p>
<p><b>T45553</b></p> 	<p><b>Description:</b> BUSH</p> <p><b>Packaging Unit:</b> 1</p> <p><b>OEM No :</b> 0730 162 428</p> <p><b>Model:</b> 5S 580 5S 600BO 9S 75 S5 42 S5 42 KAVZ S5 42 KMZ S5 42 MAZ S5 42 SNVI S5 420 S5 47</p> <p><b>EX / CROSS :</b> 0730 161 689</p>



<p><b>T08837</b></p> 	<p><b>Description:</b> BUSH</p> <p><b>OEM No :</b> 1269 304 003</p> <p><b>EX / CROSS :</b> 1268 305 092</p>	<p><b>Packaging Unit:</b> 1</p> <p><b>Model:</b></p>																								
<p><b>T16568</b></p> 	<p><b>Description:</b> BUSH</p> <p><b>OEM No :</b> 0730 260 330</p> <p><b>EX / CROSS :</b></p>	<p><b>Packaging Unit:</b> 5</p> <p><b>Model:</b></p>																								
<p><b>T22535</b></p> 	<p><b>Description:</b> BUSH</p> <p><b>OEM No :</b> 1290 304 056</p> <p><b>EX / CROSS :</b></p>	<p><b>Packaging Unit:</b> 1</p> <p><b>Model:</b> 6S 700BO 6S 700BO KAVZ 6S 850 6S 850 DAF 6S 850 MAN 6S 890 S6 36 S6 36+GV36 S6 36/2</p>																								
<p><b>T23287</b></p> 	<p><b>Description:</b> BUSH</p> <p><b>OEM No :</b> 1269 338 103</p> <p><b>EX / CROSS :</b></p>	<p><b>Packaging Unit:</b> 1</p> <p><b>Model:</b> 9S 1115TD 9S 1315TO</p>																								
<p><b>T20643</b></p> 	<p><b>Description:</b> BUSH</p> <p><b>OEM No :</b> 1312 304 084</p> <p><b>EX / CROSS :</b></p>	<p><b>Packaging Unit:</b> 1</p> <p><b>Model:</b></p> <table border="0"> <tr> <td>16S 1685</td> <td>16S 1930TD</td> </tr> <tr> <td>16S 181</td> <td>16S 1931TD IT</td> </tr> <tr> <td>16S 181 IVE</td> <td>16S 1933TD</td> </tr> <tr> <td>16S 181 MAN</td> <td>16S 1935TD</td> </tr> <tr> <td>16S 181 RVI</td> <td>16S 1937TD IT</td> </tr> <tr> <td>16S 181IT DAF</td> <td>16S 220</td> </tr> <tr> <td>16S 182</td> <td>16S 220A</td> </tr> <tr> <td>16S 1920TD</td> <td>16S 221</td> </tr> <tr> <td>16S 1921TD IT</td> <td>16S 221 DAF</td> </tr> <tr> <td>16S 1922TD</td> <td>16S 221 IVE</td> </tr> <tr> <td>16S 1923TD</td> <td>16S 221 MAN</td> </tr> <tr> <td>16S 1925TD</td> <td>16S 221 MB</td> </tr> </table>	16S 1685	16S 1930TD	16S 181	16S 1931TD IT	16S 181 IVE	16S 1933TD	16S 181 MAN	16S 1935TD	16S 181 RVI	16S 1937TD IT	16S 181IT DAF	16S 220	16S 182	16S 220A	16S 1920TD	16S 221	16S 1921TD IT	16S 221 DAF	16S 1922TD	16S 221 IVE	16S 1923TD	16S 221 MAN	16S 1925TD	16S 221 MB
16S 1685	16S 1930TD																									
16S 181	16S 1931TD IT																									
16S 181 IVE	16S 1933TD																									
16S 181 MAN	16S 1935TD																									
16S 181 RVI	16S 1937TD IT																									
16S 181IT DAF	16S 220																									
16S 182	16S 220A																									
16S 1920TD	16S 221																									
16S 1921TD IT	16S 221 DAF																									
16S 1922TD	16S 221 IVE																									
16S 1923TD	16S 221 MAN																									
16S 1925TD	16S 221 MB																									

<p><b>T20028</b></p> 	<p><b>Description:</b> BUSH</p> <p><b>OEM No :</b> 1313 304 038</p> <p><b>EX / CROSS :</b></p>	<p><b>Packaging Unit:</b> 1</p> <p><b>Model:</b></p> <ul style="list-style-type: none"> <li>16S 150</li> <li>16S 151</li> <li>16S 151 DAF</li> <li>16S 151 HIN</li> <li>16S 151 HYU</li> <li>16S 151 IVE</li> <li>16S 151 KMZ</li> <li>16S 151 MAN</li> <li>16S 151 RVI</li> <li>16S 151 SNVI</li> <li>16S 151IT DAF</li> <li>16S 151PTO HIN</li> <li>16S 1620TD</li> <li>16S 1621TD IT</li> <li>16S 1625TD</li> <li>16S 162TD IT</li> <li>16S 1630TD</li> <li>16S 1631TD IT</li> <li>16S 1635TD</li> <li>16S 163TD IT</li> <li>16S 1820TO</li> <li>16S 1820TO KMZ</li> <li>16S 1820TO RVI</li> <li>16S 1821TO IT</li> </ul>
<p><b>T08863</b></p> 	<p><b>Description:</b> BUSH</p> <p><b>OEM No :</b> 1269 304 197</p> <p><b>EX / CROSS :</b></p>	<p><b>Packaging Unit:</b> 1</p> <p><b>Model:</b></p>
<p><b>T08865</b></p> 	<p><b>Description:</b> BUSH</p> <p><b>OEM No :</b> 1292 304 027</p> <p><b>EX / CROSS :</b></p>	<p><b>Packaging Unit:</b> 1</p> <p><b>Model:</b></p>
<p><b>T08840</b></p> 	<p><b>Description:</b> BUSH</p> <p><b>OEM No :</b> 1269 304 004</p> <p><b>EX / CROSS :</b></p>	<p><b>Packaging Unit:</b> 1</p> <p><b>Model:</b></p>
<p><b>T09757</b></p> 	<p><b>Description:</b> BUSH</p> <p><b>OEM No :</b> 1297 304 035</p> <p><b>EX / CROSS :</b></p>	<p><b>Packaging Unit:</b> 1</p> <p><b>Model:</b></p>



**T19190**

**Description:**  
BUSH

**Packaging Unit:** 1

**OEM No :**  
1315 304 132

**Model:**

16S 150  
16S 151  
16S 151 DAF  
16S 151 HIN  
16S 151 HYU  
16S 151 IVE  
16S 151 KMZ  
16S 151 MAN  
16S 151 RVI  
16S 151 SNVI  
16S 151IT DAF  
16S 151PTO HIN  
16S 1620TD  
16S 1621TD IT  
16S 1625TD  
16S 162TD IT  
16S 1630TD  
16S 1631TD IT  
16S 1635TD  
16S 163TD IT  
16S 1820TO  
16S 1820TO KMZ  
16S 1820TO RVI  
16S 1821TO IT

**EX / CROSS :**  
1313 304 036



**T78294**

**Description:**  
BUSH (25X30X29)

**Packaging Unit:** 1

**OEM No :**  
0735 295 223

**Model:**

6AS 1000TO  
6AS 1005TO  
6AS 800TO  
6AS 805TO  
6S 1000TO  
6S 1005TO  
6S 1010BO  
6S 800TO  
AS Tronic

**EX / CROSS :**



**T37620**

**Description:**  
BUSH (25X31X26)

**Packaging Unit:** 1

**OEM No :**  
0735 295 119

**Model:**

6AS 700TO  
6S 700BO  
6S 700BO KAVZ  
6S 850  
6S 850 DAF  
6S 850 MAN  
6S 890  
AS Tronic  
S5 680  
S6 36  
S6 36+GV36  
S6 36/2

**EX / CROSS :**  
0730 161 354

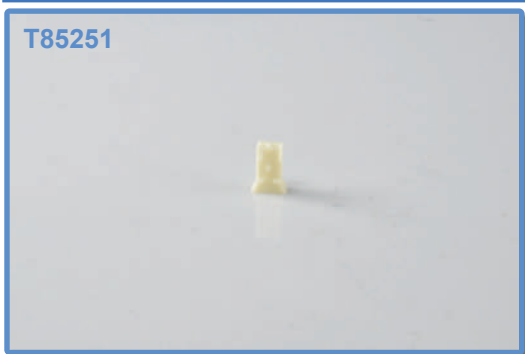

**T85251**

**Description:**  
BUSH HOUSING

**Packaging Unit:** 1

**OEM No :**  
0501 316 270

**Model:**

**EX / CROSS :**



**T61284**

**Description:**  
CARRIER HUB 117 T

**Packaging Unit:**

**OEM No :**  
1304 332 210

**Model:**

8S 180  
8S 2100  
8S 2100BD  
8S 2100BO  
8S 2101BD IT  
8S 2101BO IT

**EX / CROSS :**



<p><b>T61274</b></p> 	<p><b>Description:</b> CARRIER HUB 86 T</p> <p><b>OEM No :</b> 1304 332 215</p> <p><b>EX / CROSS :</b></p>	<p><b>Packaging Unit:</b></p> <p><b>Model:</b> 16S 109 8S 140 9S 109</p>
<p><b>T41595</b></p> 	<p><b>Description:</b> CLUTCH BOOSTER</p> <p><b>OEM No :</b> 0501 212 474</p> <p><b>EX / CROSS :</b></p>	<p><b>Packaging Unit:</b> 1</p> <p><b>Model:</b></p>
<p><b>T73628</b></p> 	<p><b>Description:</b> CONSTANT GEAR</p> <p><b>OEM No :</b> 1358 302 203</p> <p><b>EX / CROSS :</b></p>	<p><b>Packaging Unit:</b> 1</p> <p><b>Model:</b> 12 TX 2420 TD (1358 001 042) 12 TX 2420 TD (1358 001 043) 12 TX 2420 TD (1358 001 046) 12 TX 2420 TD (1358 001 047) 12 TX 2420 TD (1358 001 048) 12 TX 2421 TD IT (1358 040 038) 12 TX 2421 TD IT (1358 040 057) 12 TX 2421 TD IT (1358 040 058) 12 TX 2421 TD IT (1358 040 060) 12 TX 2620 TD IT (1358 001 041/057) 12 TX 2620 TD IT (1358 001 055/096) 12 TX 2620 TD IT (1358 001 056/070) 12 TX 2620 TD IT (1358 001 066) 12 TX 2620 TD IT (1358 001 068/155) 12 TX 2620 TD IT (1358 001 071) 12 TX 2620 TD IT (1358 001 079)</p>
<p><b>T19521</b></p> 	<p><b>Description:</b> CONSTANT GEAR (26-58T.)</p> <p><b>OEM No :</b> 1297 302 241</p> <p><b>EX / CROSS :</b> 1297 302 079</p>	<p><b>Packaging Unit:</b> 1</p> <p><b>Model:</b> 16S 160 16S 160/1 16S 160A 16S 190 16S 190/1 16S 190A 16S 190A/1</p>
<p><b>T09771</b></p> 	<p><b>Description:</b> CONSTANT GEAR (28-58T.)</p> <p><b>OEM No :</b> 1295 302 071</p> <p><b>EX / CROSS :</b></p>	<p><b>Packaging Unit:</b> 1</p> <p><b>Model:</b></p>





<p><b>T09773</b></p> 	<p><b>Description:</b> CONSTANT GEAR (28-58T.)</p> <p><b>OEM No :</b> 1297 302 176</p> <p><b>EX / CROSS :</b> 1297 302 071</p>	<p><b>Packaging Unit:</b> 1</p> <p><b>Model:</b></p>
<p><b>T15014</b></p> 	<p><b>Description:</b> CONSTANT GEAR (28-61T.)</p> <p><b>OEM No :</b> 1297 302 074</p> <p><b>EX / CROSS :</b></p>	<p><b>Packaging Unit:</b> 1</p> <p><b>Model:</b></p>
<p><b>T15362</b></p> 	<p><b>Description:</b> CONSTANT GEAR (28-61T.)</p> <p><b>OEM No :</b> 1295 302 074</p> <p><b>EX / CROSS :</b></p>	<p><b>Packaging Unit:</b> 1</p> <p><b>Model:</b></p>
<p><b>T46559</b></p> 	<p><b>Description:</b> CONSTANT GEAR (28T.)</p> <p><b>OEM No :</b> 0091 302 160</p> <p><b>EX / CROSS :</b></p>	<p><b>Packaging Unit:</b> 1</p> <p><b>Model:</b> 16S 1650</p>
<p><b>T46590</b></p> 	<p><b>Description:</b> CONSTANT GEAR (28T.)</p> <p><b>OEM No :</b> 0091 304 315</p> <p><b>EX / CROSS :</b> 0091 304 219</p>	<p><b>Packaging Unit:</b> 1</p> <p><b>Model:</b> 16S 1650 16S 1650 IVE</p>

<p><b>T19500</b></p> 	<p><b>Description:</b> CONSTANT GEAR (29-58T.)</p> <p><b>OEM No :</b> 1295 302 122</p> <p><b>EX / CROSS :</b> 1295 302 168</p> <p><b>Model:</b> 16K 130 16S 130 16S 130/1</p>	<p><b>Packaging Unit:</b> 1</p>
<p><b>T19140</b></p> 	<p><b>Description:</b> CONSTANT GEAR (30-30T.)</p> <p><b>OEM No :</b> 1316 302 066</p> <p><b>EX / CROSS :</b></p>	<p><b>Packaging Unit:</b> 1</p> <p><b>Model:</b> 16S 1685 16S 181 16S 181 IVE 16S 181 MAN 16S 181 RVI 16S 181IT DAF 16S 182 16S 1920TD 16S 1921TD IT 16S 1922TD 16S 1923TD 16S 1925TD 16S 1930TD 16S 1931TD IT 16S 1933TD 16S 1935TD 16S 1937TD IT 16S 221 16S 221 IVE 16S 221IT IVE 16S 221IT RVI 16S 2220TD 16S 2221TD IT 16S 2222TD</p>
<p><b>T20505</b></p> 	<p><b>Description:</b> CONSTANT GEAR (30-30T.)</p> <p><b>OEM No :</b> 1315 302 157</p> <p><b>EX / CROSS :</b></p>	<p><b>Packaging Unit:</b> 1</p> <p><b>Model:</b> 16S 151 16S 151IT DAF 16S 1620TD 16S 1621TD IT 16S 1625TD 16S 162TD IT 16S 1630TD 16S 1631TD IT 16S 1635TD 16S 163TD IT 8S 151 Ecosplit III Ecosplit IV - 16 speed</p>
<p><b>T19174</b></p> 	<p><b>Description:</b> CONSTANT GEAR (30-35T.)</p> <p><b>OEM No :</b> 1315 302 158</p> <p><b>EX / CROSS :</b></p>	<p><b>Packaging Unit:</b> 1</p> <p><b>Model:</b> 16S 151 16S 151 DAF 16S 151 HYU 16S 151 IVE 16S 151 KMZ 16S 151 MAN 16S 151 RVI 16S 151 SNVI 16S 151PTO HIN 16S 1820TO 16S 1820TO KMZ 16S 1820TO RVI 16S 1821TO IT 16S 1822TO 16S 1823TO 16S 1825TO 16S 182TO IT 16S 1830TO 16S 1831TO IT 16S 1833TO 16S 1835TO 16S 183TO IT 8S 151 8S 1820TO</p>
<p><b>T11774</b></p> 	<p><b>Description:</b> CONSTANT GEAR (30-58T.)</p> <p><b>OEM No :</b> 1297 302 177</p> <p><b>EX / CROSS :</b> 1297 302 070</p>	<p><b>Packaging Unit:</b> 1</p> <p><b>Model:</b></p>





<p><b>T19448</b></p> 	<p><b>Description:</b> CONSTANT GEAR (30-58T.)</p> <p><b>OEM No :</b> 1295 302 070</p> <p><b>EX / CROSS :</b></p>	<p><b>Packaging Unit:</b> 1</p> <p><b>Model:</b> 16K 130 16S 130 16S 130/1</p>
<p><b>T74483</b></p> 	<p><b>Description:</b> CONSTANT GEAR (30T.)</p> <p><b>OEM No :</b> 1304 302 150</p> <p><b>EX / CROSS :</b></p>	<p><b>Packaging Unit:</b> 1</p> <p><b>Model:</b> 16S 109</p>
<p><b>T46563</b></p> 	<p><b>Description:</b> CONSTANT GEAR (30T.)</p> <p><b>OEM No :</b> 0091 302 179</p> <p><b>EX / CROSS :</b> 0091 302 272</p>	<p><b>Packaging Unit:</b> 1</p> <p><b>Model:</b> 16S 1650</p>
<p><b>T74488</b></p> 	<p><b>Description:</b> CONSTANT GEAR (31T.)</p> <p><b>OEM No :</b> 1304 303 283</p> <p><b>EX / CROSS :</b></p>	<p><b>Packaging Unit:</b> 1</p> <p><b>Model:</b> 16S 109</p>
<p><b>T70037</b></p> 	<p><b>Description:</b> CONSTANT GEAR (31T.)</p> <p><b>OEM No :</b> 1304 303 294</p> <p><b>EX / CROSS :</b></p>	<p><b>Packaging Unit:</b> 1</p> <p><b>Model:</b> 8S 180 8S 2100 8S 2100BO 8S 2101BO IT</p>



<p><b>T53404</b></p> 	<p><b>Description:</b> CONSTANT GEAR (31T.)</p> <p><b>OEM No :</b> 0091 303 147</p> <p><b>EX / CROSS :</b></p>	<p><b>Packaging Unit:</b> 1</p> <p><b>Model:</b> 16S 1650</p>
<p><b>T77074</b></p> 	<p><b>Description:</b> CONSTANT GEAR (32T.)</p> <p><b>OEM No :</b> 1328 302 062</p> <p><b>EX / CROSS :</b></p>	<p><b>Packaging Unit:</b> 1</p> <p><b>Model:</b> 16AS 2230TD 16AS 2231TD IT 16AS 2600TO 16AS 2601TO IT AS Tronic</p>
<p><b>T19384</b></p> 	<p><b>Description:</b> CONSTANT GEAR (34-30T.)</p> <p><b>OEM No :</b> 1316 302 065</p> <p><b>EX / CROSS :</b></p>	<p><b>Packaging Unit:</b> 1</p> <p><b>Model:</b> 16S 221 16S 221 DAF 16S 221 MB Ecosplit III</p>
<p><b>T18554</b></p> 	<p><b>Description:</b> CONSTANT GEAR (34-30T.)</p> <p><b>OEM No :</b> 1315 302 008</p> <p><b>EX / CROSS :</b></p>	<p><b>Packaging Unit:</b> 1</p> <p><b>Model:</b> 16S 151 Ecosplit III</p>
<p><b>T17790</b></p> 	<p><b>Description:</b> CONSTANT GEAR (34-30T.)</p> <p><b>OEM No :</b> 1315 302 173</p> <p><b>EX / CROSS :</b></p>	<p><b>Packaging Unit:</b> 1</p> <p><b>Model:</b> 16S 151 16S 151 HIN Ecosplit III</p>

<p><b>T20005</b></p> 	<p><b>Description:</b> CONSTANT GEAR (34-30T.)</p> <p><b>OEM No :</b> 1313 302 036</p> <p><b>EX / CROSS :</b> 1313 302 001</p>	<p><b>Packaging Unit:</b> 1</p> <p><b>Model:</b> 16S 150</p>
<p><b>T57366</b></p> 	<p><b>Description:</b> CONSTANT GEAR (34T.)</p> <p><b>OEM No :</b> 1328 304 044</p> <p><b>EX / CROSS :</b></p>	<p><b>Packaging Unit:</b> 1</p> <p><b>Model:</b> 16AS 2230TD 16AS 2231TD IT 16AS 2600TO 16AS 2601TO IT 16AS 2630TO 16AS 2631TO IT 16AS 2635TO AS Tronic</p>
<p><b>T73631</b></p> 	<p><b>Description:</b> CONSTANT GEAR (34T.)</p> <p><b>OEM No :</b> 1358 302 224</p> <p><b>EX / CROSS :</b></p>	<p><b>Packaging Unit:</b> 1</p> <p><b>Model:</b> 12 TX 2420 TD (1358 001 042) 12 TX 2420 TD (1358 001 043) 12 TX 2420 TD (1358 001 046) 12 TX 2420 TD (1358 001 047) 12 TX 2420 TD (1358 001 048) 12 TX 2421 TD IT (1358 040 038) 12 TX 2421 TD IT (1358 040 057) 12 TX 2421 TD IT (1358 040 058) 12 TX 2421 TD IT (1358 040 060) 12 TX 2620 TD IT (1358 001 041/057) 12 TX 2620 TD IT (1358 001 055/096) 12 TX 2620 TD IT (1358 001 056/070) 12 TX 2620 TD IT (1358 001 066) 12 TX 2620 TD IT (1358 001 068/155) 12 TX 2620 TD IT (1358 001 071) 12 TX 2620 TD IT (1358 001 072)</p>
<p><b>T19388</b></p> 	<p><b>Description:</b> CONSTANT GEAR (35-30T.)</p> <p><b>OEM No :</b> 1316 302 067</p> <p><b>EX / CROSS :</b></p>	<p><b>Packaging Unit:</b> 1</p> <p><b>Model:</b> 16S 221 16S 221 RVI 16S 221 VW 16S 2220TO 16S 2220TO IT 16S 2220TO IVE 16S 2221TO IT 16S 2222TO 16S 2223TO 16S 2225TO 16S 222TO IT 16S 2230TO 16S 2230TO RVI 16S 2231TO IT 16S 2233TO 16S 2235TO 16S 223TO IT 16S 2280TO 16S 251 16S 251 NIS 16S 2520TO 16S 2520TO MAN 16S 2521TO IT 16S 2522TO</p>
<p><b>T19379</b></p> 	<p><b>Description:</b> CONSTANT GEAR (35-30T.)</p> <p><b>OEM No :</b> 1316 302 057</p> <p><b>EX / CROSS :</b></p>	<p><b>Packaging Unit:</b> 1</p> <p><b>Model:</b> 16S 181 Ecosplit III</p>

<p><b>T53391</b></p> 	<p><b>Description:</b> CONSTANT GEAR (36T.)</p> <p><b>OEM No :</b> 0091 302 276</p> <p><b>EX / CROSS :</b></p>	<p><b>Packaging Unit:</b> 1</p> <p><b>Model:</b> 16S 1650</p>
<p><b>T75473</b></p> 	<p><b>Description:</b> CONSTANT GEAR (36T.)</p> <p><b>OEM No :</b> 1327 302 005</p> <p><b>EX / CROSS :</b></p>	<p><b>Packaging Unit:</b> 1</p> <p><b>Model:</b> 12AS 1630TD 12AS 1631TD IT 12AS 1930TD 12AS 1931TD IT 12AS 1935TD 12AS 2130TD 12AS 2131TD IT 12AS 2301 12AS 2301IT 12AS 2330TD 12AS 2331TD IT 12AS 2335TD</p> <p>AS Tronic</p>
<p><b>T74493</b></p> 	<p><b>Description:</b> CONSTANT GEAR (36T.)</p> <p><b>OEM No :</b> 1324 303 007</p> <p><b>EX / CROSS :</b></p>	<p><b>Packaging Unit:</b> 1</p> <p><b>Model:</b> 9S 1110TD 9S 1111TD IT 9S 1115TD</p>
<p><b>T72375</b></p> 	<p><b>Description:</b> CONSTANT GEAR (36T.)</p> <p><b>OEM No :</b> 1290 303 221</p> <p><b>EX / CROSS :</b></p>	<p><b>Packaging Unit:</b> 1</p> <p><b>Model:</b> 6S 850</p>
<p><b>T39344</b></p> 	<p><b>Description:</b> CONSTANT GEAR (36T.)</p> <p><b>OEM No :</b> 0091 302 294</p> <p><b>EX / CROSS :</b></p>	<p><b>Packaging Unit:</b> 1</p> <p><b>Model:</b> 16S 1650</p>

<p><b>T41353</b></p> 	<p><b>Description:</b> CONSTANT GEAR (36T.)</p> <p><b>OEM No :</b> 1329 302 002</p> <p><b>EX / CROSS :</b></p>	<p><b>Packaging Unit:</b> 1</p> <p><b>Model:</b> 12AS 2140TD 12AS 2340TD 12AS 2341TD IT 12AS 2540TD 12AS 2541TD IT 12AS 3000TD 12AS 3000TD IT 12AS 3001 12AS 3001IT</p>
<p><b>T73344</b></p> 	<p><b>Description:</b> CONSTANT GEAR (37T.)</p> <p><b>OEM No :</b> 1316 303 002</p> <p><b>EX / CROSS :</b></p>	<p><b>Packaging Unit:</b> 1</p> <p><b>Model:</b> 16S 221 Ecosplit III</p>
<p><b>T80212</b></p> 	<p><b>Description:</b> CONSTANT GEAR (37T.)</p> <p><b>OEM No :</b> 1308 303 023</p> <p><b>EX / CROSS :</b></p>	<p><b>Packaging Unit:</b> 1</p> <p><b>Model:</b> 9S 75</p>
<p><b>T41357</b></p> 	<p><b>Description:</b> CONSTANT GEAR (38T.)</p> <p><b>OEM No :</b> 1329 304 011</p> <p><b>EX / CROSS :</b> 1329 304 002</p>	<p><b>Packaging Unit:</b> 1</p> <p><b>Model:</b> 12AS 2140TD 12AS 2340TD 12AS 2341TD IT 12AS 2540TD 12AS 2540TO 12AS 2541TD IT 12AS 2541TO IT 12AS 2740TO 12AS 2741TO IT 12AS 2940TO 12AS 2941TO IT 12AS 3000TD 12AS 3000TD IT 12AS 3000TO IT 12AS 3001 12AS 3001IT 12AS 3140TO 12AS 3141TO IT</p>
<p><b>T57335</b></p> 	<p><b>Description:</b> CONSTANT GEAR (40T.)</p> <p><b>OEM No :</b> 1328 302 063</p> <p><b>EX / CROSS :</b></p>	<p><b>Packaging Unit:</b> 1</p> <p><b>Model:</b> 16AS 2600TO 16AS 2601TO IT 16AS 2630TO 16AS 2631TO IT 16AS 2635TO AS Tronic</p>

<p><b>T60555</b></p> 	<p><b>Description:</b> CONSTANT GEAR (40T.)</p> <p><b>Packaging Unit:</b> 1</p> <p><b>OEM No :</b> 1327 304 015</p> <p><b>Model:</b> 10AS 2010B IT 10AS 2300BO 10AS 2310B 10AS 2310B IT 10AS 2700BO 12AS 1601BO IT 12AS 1630TD 12AS 1631TD IT 12AS 1930TD 12AS 1930TO 12AS 1931TD IT 12AS 1931TO IT</p> <p><b>EX / CROSS :</b> 1327 304 031</p> <p>12AS 1935TD 12AS 2000B IT 12AS 2000BO 12AS 2001BO IT 12AS 2130TD 12AS 2130TO 12AS 2131TD IT 12AS 2131TO IT 12AS 2300B IT 12AS 2300BO 12AS 2301 12AS 2301BO IT</p>
<p><b>T54721</b></p> 	<p><b>Description:</b> CONSTANT GEAR (46T.)</p> <p><b>Packaging Unit:</b> 1</p> <p><b>OEM No :</b> 1268 303 140</p> <p><b>Model:</b> S6 1550</p> <p><b>EX / CROSS :</b></p>
<p><b>T75480</b></p> 	<p><b>Description:</b> CONSTANT GEAR (46T.)</p> <p><b>Packaging Unit:</b> 1</p> <p><b>OEM No :</b> 1327 302 006</p> <p><b>Model:</b> 10AS 2010B IT 10AS 2300BO 10AS 2310B 10AS 2310B IT 10AS 2700BO 12AS 1601BO IT 12AS 1930TO 12AS 1931TO IT 12AS 2000B IT 12AS 2000BO 12AS 2001BO IT 12AS 2130TO</p> <p><b>EX / CROSS :</b></p> <p>12AS 2131TO IT 12AS 2300B IT 12AS 2300BO 12AS 2301 12AS 2301BO IT 12AS 2301IT 12AS 2330TO 12AS 2331TO IT 12AS 2335TO 12AS 2530TO 12AS 2531TO IT 12AS 2700BO</p>
<p><b>T60731</b></p> 	<p><b>Description:</b> CONSTANT GEAR 26 T</p> <p><b>Packaging Unit:</b> 1</p> <p><b>OEM No :</b> 1304 302 169</p> <p><b>Model:</b> 16S 109</p> <p><b>EX / CROSS :</b></p>
<p><b>T19051</b></p> 	<p><b>Description:</b> CONSTANT GEAR CNTRSHFT (32T.)</p> <p><b>Packaging Unit:</b> 1</p> <p><b>OEM No :</b> 1316 303 071</p> <p><b>Model:</b> 16S 221 RVI 16S 221 VW 16S 2280TO 16S 251 NIS 16S 2520TO MAN</p> <p><b>EX / CROSS :</b> 1316 303 064</p>



**Description:**  
CONSTANT GEAR CNTRSHFT (32T.)

**Packaging Unit:** 1

**OEM No :**  
1315 303 064

**Model:**  
16S 151 DAF  
16S 151 HYU  
16S 151 KMZ  
16S 151 MAN  
16S 151 RVI  
16S 151 SNVI

**EX / CROSS :**  
1315 303 051

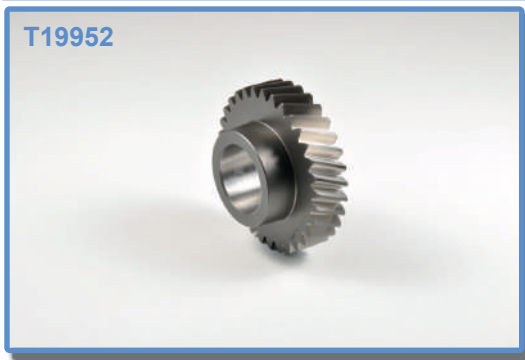

**Description:**  
CONSTANT GEAR CNTRSHFT (32T.)

**Packaging Unit:** 1

**OEM No :**  
1297 303 098

**Model:**  
16K 160  
16K 190  
16S 160  
16S 160/1  
16S 190  
16S 190A

**EX / CROSS :**  
1297 303 051



**Description:**  
CONSTANT GEAR CNTRSHFT (32T.)

**Packaging Unit:** 1

**OEM No :**  
1316 303 056

**Model:**  
16S 181  
Ecosplit III

**EX / CROSS :**  
1316 303 070



**Description:**  
CONSTANT GEAR CNTRSHFT (32T.)

**Packaging Unit:** 1

**OEM No :**  
1295 303 060

**Model:**  
16K 130  
16S 130  
16S 130/1

**EX / CROSS :**  
1295 303 092





**Description:**  
CONSTANT GEAR CNTRSHFT (33T.)

**Packaging Unit:** 1

**OEM No :**  
1324 303 004

**Model:**  
9S 1110TO  
9S 1111TO IT  
9S 1115TO  
9S 1310TO  
9S 1310TO KMZ  
9S 1311TO IT  
9S 1315TO

**EX / CROSS :**

<p><b>T19971</b></p> 	<p><b>Description:</b> CONSTANT GEAR CNTRSHFT (35T.)</p> <p><b>OEM No :</b> 1297 303 086</p> <p><b>EX / CROSS :</b> 1297 303 043</p> <p><b>Model:</b> 16S 160 16S 160/1 16S 160A 16S 190 16S 190/1 16S 190A 16S 190A/1</p>	<p><b>Packaging Unit:</b> 1</p>
<p><b>T22610</b></p> 	<p><b>Description:</b> CONSTANT GEAR CNTRSHFT (36T.)</p> <p><b>OEM No :</b> 1290 303 200</p> <p><b>EX / CROSS :</b></p> <p><b>Model:</b> 6S 700BO 6S 700BO KAVZ 6S 850 6S 890</p>	<p><b>Packaging Unit:</b> 1</p>
<p><b>T17800</b></p> 	<p><b>Description:</b> CONSTANT GEAR CNTRSHFT (37T.)</p> <p><b>OEM No :</b> 1315 303 052</p> <p><b>EX / CROSS :</b> 1315 303 012</p> <p><b>Model:</b> 16S 151 16S 151 HIN Ecosplit III</p>	<p><b>Packaging Unit:</b> 1</p>
<p><b>T20480</b></p> 	<p><b>Description:</b> CONSTANT GEAR CNTRSHFT (37T.)</p> <p><b>OEM No :</b> 1316 303 031</p> <p><b>EX / CROSS :</b></p> <p><b>Model:</b> 16S 221 16S 221 DAF 16S 221 MB Ecosplit III</p>	<p><b>Packaging Unit:</b> 1</p>
<p><b>T20016</b></p> 	<p><b>Description:</b> CONSTANT GEAR CNTRSHFT (37T.)</p> <p><b>OEM No :</b> 1313 303 004</p> <p><b>EX / CROSS :</b></p> <p><b>Model:</b> 16S 150</p>	<p><b>Packaging Unit:</b> 1</p>

<p><b>T20510</b></p> 	<p><b>Description:</b> CONSTANT GEAR CNTRSHFT (39T.)</p> <p><b>Packaging Unit:</b> 1</p> <p><b>OEM No :</b> 1315 303 008</p> <p><b>Model:</b> 16S 151 16S 151IT DAF 16S 1620TD 16S 1621TD IT 16S 1625TD 16S 162TD IT 16S 1630TD 16S 1631TD IT 16S 1635TD 16S 163TD IT 8S 151 Ecosplit III</p> <p><b>EX / CROSS :</b></p> <p>Ecosplit IV - 16 speed</p>
<p><b>T20530</b></p> 	<p><b>Description:</b> CONSTANT GEAR CNTRSHFT (39T.)</p> <p><b>Packaging Unit:</b> 1</p> <p><b>OEM No :</b> 1316 303 055</p> <p><b>Model:</b> 16S 181 16S 181 IVE 16S 181 MAN 16S 181 RVI 16S 181IT DAF 16S 182 Ecosplit III</p> <p><b>EX / CROSS :</b></p>
<p><b>T20525</b></p> 	<p><b>Description:</b> CONSTANT GEAR CNTRSHFT (39T.)</p> <p><b>Packaging Unit:</b> 1</p> <p><b>OEM No :</b> 1316 303 030</p> <p><b>Model:</b> 16S 1685 16S 1920TD 16S 1921TD IT 16S 1922TD 16S 1923TD 16S 1925TD 16S 1930TD 16S 1931TD IT 16S 1933TD 16S 1935TD 16S 193TD IT 16S 221 16S 221 IVE 16S 221 MAN 16S 221IT IVE 16S 221IT RVI 16S 2220TD 16S 2221TD IT 16S 2222TD 16S 2223TD 16S 2225TD 16S 222TD IT 16S 2230TD 16S 2231TD IT</p> <p><b>EX / CROSS :</b></p>
<p><b>T23772</b></p> 	<p><b>Description:</b> CONSTANT GEAR CNTRSHFT (43T.)</p> <p><b>Packaging Unit:</b> 1</p> <p><b>OEM No :</b> 1307 303 123</p> <p><b>Model:</b> 5S 600BO S5 42 S5 42 KAVZ S5 47</p> <p><b>EX / CROSS :</b> 1307 303 060</p>
<p><b>T22169</b></p> 	<p><b>Description:</b> CONSTANT GEAR CNTRSHFT (45T.)</p> <p><b>Packaging Unit:</b> 1</p> <p><b>OEM No :</b> 1307 395 316</p> <p><b>Model:</b> S5 42 KMZ S5 42 MAZ S5 42 SNVI S5 47</p> <p><b>EX / CROSS :</b> 1307 303 122 1307 303 014</p>



<p><b>T57310</b></p> 	<p><b>Description:</b> CONSTANT GEAR CNTRSHFT (47T.)</p> <p><b>OEM No :</b> 1310 303 069</p> <p><b>EX / CROSS :</b> 1310 303 056</p> <p><b>Model:</b> 6S 1350 BO 6S 1700BO 6S 1701BO IT 6S 1900BO 6S 1901BO IT</p>	<p><b>Packaging Unit:</b> 1</p>
<p><b>T38437</b></p> 	<p><b>Description:</b> CONSTANT GEAR CNTRSHFT (47T.)</p> <p><b>OEM No :</b> 1310 303 032</p> <p><b>EX / CROSS :</b></p> <p><b>Model:</b> 6S 1000BO 6S 1200BO 6S 1200BO IKA 6S 1200BO KMZ 6S 1200TO S6 85 S6 85 LIAZ S6 85 MAN S6 85 NEFAZ</p>	<p><b>Packaging Unit:</b> 1</p>
<p><b>T70031</b></p> 	<p><b>Description:</b> COUNTERSHAFT</p> <p><b>OEM No :</b> 1304 303 291</p> <p><b>EX / CROSS :</b></p> <p><b>Model:</b> 8S 180 8S 2100 8S 2100BO 8S 2101BO IT</p>	<p><b>Packaging Unit:</b> 1</p>
<p><b>T54714</b></p> 	<p><b>Description:</b> COUNTERSHAFT</p> <p><b>OEM No :</b> 0091 303 136</p> <p><b>EX / CROSS :</b> 1268 303 138</p> <p><b>Model:</b> S6 1550</p>	<p><b>Packaging Unit:</b> 1</p>
<p><b>T22522</b></p> 	<p><b>Description:</b> COUNTERSHAFT (11-17T.)</p> <p><b>OEM No :</b> 1290 203 039</p> <p><b>EX / CROSS :</b> 1290 203 043 1290 303 192</p> <p><b>Model:</b> 6S 700BO 6S 700BO KAVZ 6S 850 6S 890 S6 36 S6 36/2</p>	<p><b>Packaging Unit:</b> 1</p>



**T77198**



**Description:**  
COUNTERSHAFT (11-18T.)

**Packaging Unit:** 1

**OEM No :**  
1346 203 001

**Model:**  
6AS 1000TO  
6AS 1005TO  
6AS 1010BO  
6AS 1110BO  
6S 1000TO  
6S 1005TO  
6S 1010BO  
AS Tronic

**EX / CROSS :**  
1346 303 064

**T14796**



**Description:**  
COUNTERSHAFT (12-13-24T.)

**Packaging Unit:** 1

**OEM No :**  
1283 303 002

**Model:**

**EX / CROSS :**

**T08440**



**Description:**  
COUNTERSHAFT (12-15T.)

**Packaging Unit:** 1

**OEM No :**  
1250 203 002

**Model:**

**EX / CROSS :**  
1250 303 032  
1250 303 099

**T08442**



**Description:**  
COUNTERSHAFT (12-17T.)

**Packaging Unit:** 1

**OEM No :**  
1268 203 001

**Model:**

**EX / CROSS :**  
1268 203 002  
1268 203 055  
1268 303 001  
1268 303 032

**T77268**



**Description:**  
COUNTERSHAFT (12-18T.)

**Packaging Unit:** 1

**OEM No :**  
1310 303 053

**Model:**  
6S 1350 BO  
6S 1600BD  
6S 1601BD IT  
6S 1700BO  
6S 1701BO IT  
6S 1900BO  
6S 1901BO IT

**EX / CROSS :**



**Description:**  
COUNTERSHAFT (12-18T.)

**Packaging Unit:** 1

**OEM No :**  
1310 303 076

**Model:**  
6S 1000BD  
6S 1000BO  
6S 1200BD  
6S 1200BO  
6S 1200TD  
6S 1200TO  
6S 1205TD  
S6 85

**EX / CROSS :**  
1310 203 001  
1310 303 021



**Description:**  
COUNTERSHAFT (13T.)

**Packaging Unit:** 1

**OEM No :**  
1292 303 004

**Model:**

**EX / CROSS :**



**Description:**  
COUNTERSHAFT (13T.)

**Packaging Unit:** 1

**OEM No :**  
1272 303 040

**Model:**

**EX / CROSS :**



**Description:**  
COUNTERSHAFT (14T.-21T.)

**Packaging Unit:** 1

**OEM No :**  
1307 395 079

**Model:**  
S5 42

**EX / CROSS :**



**Description:**  
COUNTERSHAFT (14T.)

**Packaging Unit:** 1

**OEM No :**  
1324 303 001

**Model:**  
9S 1110TD  
9S 1110TO  
9S 1111TD IT  
9S 1111TO IT  
9S 1115TD  
9S 1115TO  
9S 1310TO  
9S 1310TO KMZ  
9S 1311TO IT  
9S 1315TO

**EX / CROSS :**



T08905



**Description:**  
COUNTERSHAFT (16T.)

**Packaging Unit:** 1

**OEM No :**  
1269 303 041

**Model:**

**EX / CROSS :**  
1269 303 040

T11167



**Description:**  
COUNTERSHAFT (17-20T.)

**Packaging Unit:** 1

**OEM No :**  
1297 303 047

**Model:**

**EX / CROSS :**

T20680



**Description:**  
COUNTERSHAFT (17-20T.)

**Packaging Unit:** 1

**OEM No :**  
1315 303 042

**Model:**  
16S 151  
Ecosplit III

**EX / CROSS :**

T15364



**Description:**  
COUNTERSHAFT (17-20T.)

**Packaging Unit:** 1

**OEM No :**  
1296 303 025

**Model:**

**EX / CROSS :**  
1296 303 020

T09781



**Description:**  
COUNTERSHAFT (17-20T.)

**Packaging Unit:** 1

**OEM No :**  
1295 303 066

**Model:**

**EX / CROSS :**  
1295 303 053

<p><b>T19046</b></p> 	<p><b>Description:</b> COUNTERSHAFT (17-20T.)</p> <p><b>OEM No :</b> 1316 303 033</p> <p><b>EX / CROSS :</b></p>	<p><b>Packaging Unit:</b> 1</p> <p><b>Model:</b> 16S 1685 16S 181 16S 181 IVE 16S 181 MAN 16S 181 RVI 16S 181IT DAF 16S 182 16S 1920TD 16S 1921TD IT 16S 1922TD 16S 1923TD 16S 1925TD 16S 1930TD 16S 1931TD IT 16S 1933TD 16S 1935TD 16S 193TD IT 16S 221 16S 221 IVE 16S 221 MAN 16S 221 RVI 16S 221 VW 16S 221IT IVE 16S 221IT RVI</p>
<p><b>T20913</b></p> 	<p><b>Description:</b> COUNTERSHAFT (17-20T.)</p> <p><b>OEM No :</b> 1315 303 063</p> <p><b>EX / CROSS :</b></p>	<p><b>Packaging Unit:</b> 1</p> <p><b>Model:</b> 16S 151 DAF 16S 151 HYU 16S 151 IVE 16S 151 KMZ 16S 151 MAN 16S 151 RVI 16S 151 SNVI 16S 151IT DAF 16S 151PTO HIN 16S 1620TD 16S 1621TD IT 16S 1625TD 16S 162TD IT 16S 1630TD 16S 1631TD IT 16S 1635TD 16S 163TD IT 16S 1820TO 16S 1820TO KMZ 16S 1820TO RVI 16S 1821TO IT 16S 1822TO 16S 1823TO 16S 1825TO</p>
<p><b>T18339</b></p> 	<p><b>Description:</b> COUNTERSHAFT (17-20T.)</p> <p><b>OEM No :</b> 1297 303 140</p> <p><b>EX / CROSS :</b> 0091 302 176 1297 303 045 1297 303 053 1297 303 064</p>	<p><b>Packaging Unit:</b> 1</p> <p><b>Model:</b></p>
<p><b>T46568</b></p> 	<p><b>Description:</b> COUNTERSHAFT (17-20T.)</p> <p><b>OEM No :</b> 0091 303 146</p> <p><b>EX / CROSS :</b> 0091 303 104</p>	<p><b>Packaging Unit:</b> 1</p> <p><b>Model:</b> 16S 1650 16S 1650 IVE</p>
<p><b>T20484</b></p> 	<p><b>Description:</b> COUNTERSHAFT (19-23T.)</p> <p><b>OEM No :</b> 1316 303 034</p> <p><b>EX / CROSS :</b></p>	<p><b>Packaging Unit:</b> 1</p> <p><b>Model:</b> 16S 221 16S 221 DAF 16S 221 MB Ecosplit III</p>



T15751



**Description:**  
COUNTERSHAFT (19-23T.)

**Packaging Unit:** 1

**OEM No :**  
1297 303 075

**Model:**

**EX / CROSS :**  
1297 303 046  
1297 303 054

T62452



**Description:**  
COUNTERSHAFT (19-23T.)

**Packaging Unit:** 1

**OEM No :**  
1315 303 048

**Model:**  
16S 151  
Ecosplit III

**EX / CROSS :**  
1315 303 022

T19464



**Description:**  
COUNTERSHAFT (19-23T.)

**Packaging Unit:** 1

**OEM No :**  
1295 303 067

**Model:**  
16S 130  
16S 130/1

**EX / CROSS :**  
1295 303 054

T62465



**Description:**  
COUNTERSHAFT (19-23T.)

**Packaging Unit:** 1

**OEM No :**  
1315 303 041

**Model:**  
16S 151  
Ecosplit III

**EX / CROSS :**

T23748



**Description:**  
COUNTERSHAFT (21-14T.)



**Packaging Unit:** 1

**OEM No :**  
1307 303 104

**Model:**  
S5 42  
S5 42 KMZ  
S5 42 MAZ  
S5 42 SNVI

**EX / CROSS :**



<p><b>T37663</b></p> 	<p><b>Description:</b> COUNTERSHAFT (24-15T.)</p> <p><b>OEM No :</b> 1307 303 107</p> <p><b>EX / CROSS :</b></p>	<p><b>Packaging Unit:</b> 1</p> <p><b>Model:</b> 5S 600BO S5 42 S5 42 KAVZ</p>
<p><b>T18869</b></p> 	<p><b>Description:</b> COVER</p> <p><b>OEM No :</b> 1295 307 479</p> <p><b>EX / CROSS :</b> 0091 307 500</p>	<p><b>Packaging Unit:</b> 1</p> <p><b>Model:</b></p>
<p><b>T58944</b></p> 	<p><b>Description:</b> COVER</p> <p><b>OEM No :</b> 1328 302 118</p> <p><b>EX / CROSS :</b></p>	<p><b>Packaging Unit:</b></p> <p><b>Model:</b> 10AS 2010B IT 10AS 2300BO 10AS 2310B 10AS 2310B IT 10AS 2700BO 12AS 1601BO IT 12AS 1630TD 12AS 1631TD IT 12AS 1930TD 12AS 1930TO 12AS 1931TD IT 12AS 1931TO IT 12AS 1935TD 12AS 2000B IT 12AS 2000BO 12AS 2001BO IT 12AS 2130TD 12AS 2130TO 12AS 2131TD IT 12AS 2131TO IT 12AS 2140TD 12AS 2300B IT 12AS 2300BO 12AS 2301</p>
<p><b>T15866</b></p> 	<p><b>Description:</b> COVER</p> <p><b>OEM No :</b> 1268 308 012</p> <p><b>EX / CROSS :</b></p>	<p><b>Packaging Unit:</b> 1</p> <p><b>Model:</b></p>
<p><b>T57518</b></p> 	<p><b>Description:</b> COVER</p> <p><b>OEM No :</b> 1328 301 170</p> <p><b>EX / CROSS :</b> 1238 308 031 1238 308 165</p>	<p><b>Packaging Unit:</b> 1</p> <p><b>Model:</b> 10AS 2300BO 10AS 2310B 10AS 2310B IT 10AS 2700BO 12 TX 1815 TO (1372 002 035) PTO 12AS 1210TO 12AS 1220TD 12AS 1420TD 12AS 1420TO 12AS 1620TO 12AS 1630TD 12AS 1631TD IT 12AS 1800 12AS 1800IT 12AS 1930TD 12AS 1930TO 12AS 1931TD IT 12AS 1931TO IT 12AS 1935TD 12AS 2000BO 12AS 2130TD 12AS 2130TO 12AS 2131TD IT 12AS 2131TO IT</p>



**T11768**

**Description:**  
COVER FRONT

**Packaging Unit:** 1

**OEM No :**  
1285 302 033

**Model:**

**EX / CROSS :**

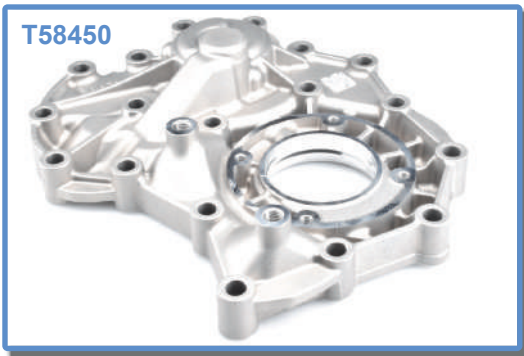

**T58450**

**Description:**  
COVER FRONT

**Packaging Unit:** 1

**OEM No :**  
1325 302 052

**Model:**

**EX / CROSS :**

12S 2130TD	16S 1625TD
12S 2131TD IT	16S 162TD IT
12S 2133TD	16S 1630TD
12S 2330TD	16S 1631TD IT
12S 2331TD IT	16S 163TD IT
12S 2333TD	16S 1820TD
12S 233TD IT	16S 1821TO IT
12S 2831TD IT	16S 182TO IT
12S 2833TD	16S 1833TO
12S 283TD IT	16S 1920TD
16S 1620TD	16S 1921TD IT
16S 1621TD IT	16S 1923TD



**T15565**

**Description:**  
COVER FRONT

**Packaging Unit:** 1

**OEM No :**  
1250 302 263

**Model:**

**EX / CROSS :**



**T15567**

**Description:**  
COVER FRONT

**Packaging Unit:** 1

**OEM No :**  
1297 302 012

**Model:**

**EX / CROSS :**



**T15569**

**Description:**  
COVER FRONT





**Packaging Unit:** 1



**OEM No :**  
1297 302 042

**Model:**

**EX / CROSS :**



<p><b>T15572</b></p> 	<p><b>Description:</b> COVER FRONT</p> <p><b>OEM No :</b> 1269 302 269</p> <p><b>EX / CROSS :</b> 1269 302 155</p>	<p><b>Packaging Unit:</b> 1</p> <p><b>Model:</b></p>																								
<p><b>T50387</b></p> 	<p><b>Description:</b> CYLINDER</p> <p><b>OEM No :</b> 0750 132 019</p> <p><b>EX / CROSS :</b></p>	<p><b>Packaging Unit:</b> 1</p> <p><b>Model:</b></p> <table border="0"> <tr> <td>4S 120GP</td> <td>5S 110GP+GV90</td> </tr> <tr> <td>4S 150GP</td> <td>5S 110GPA</td> </tr> <tr> <td>4S 150GP+400</td> <td>5S 110GPA+GV90</td> </tr> <tr> <td>5K 110GP</td> <td>5S 111GP</td> </tr> <tr> <td>5K 110GP+GV90</td> <td>5S 111GP+GV90</td> </tr> <tr> <td>5K 110GPA</td> <td>5S 111GPA</td> </tr> <tr> <td>5K 110GPA+GV90</td> <td>5S 90GP</td> </tr> <tr> <td>5K 90GP</td> <td>5S 90GPA</td> </tr> <tr> <td>5K 90GPA</td> <td>5S 92GP</td> </tr> <tr> <td>5K 91GP</td> <td></td> </tr> <tr> <td>5K 91GPA</td> <td></td> </tr> <tr> <td>5S 110GP</td> <td></td> </tr> </table>	4S 120GP	5S 110GP+GV90	4S 150GP	5S 110GPA	4S 150GP+400	5S 110GPA+GV90	5K 110GP	5S 111GP	5K 110GP+GV90	5S 111GP+GV90	5K 110GPA	5S 111GPA	5K 110GPA+GV90	5S 90GP	5K 90GP	5S 90GPA	5K 90GPA	5S 92GP	5K 91GP		5K 91GPA		5S 110GP	
4S 120GP	5S 110GP+GV90																									
4S 150GP	5S 110GPA																									
4S 150GP+400	5S 110GPA+GV90																									
5K 110GP	5S 111GP																									
5K 110GP+GV90	5S 111GP+GV90																									
5K 110GPA	5S 111GPA																									
5K 110GPA+GV90	5S 90GP																									
5K 90GP	5S 90GPA																									
5K 90GPA	5S 92GP																									
5K 91GP																										
5K 91GPA																										
5S 110GP																										
<p><b>T38899</b></p> 	<p><b>Description:</b> CYLINDER</p> <p><b>OEM No :</b> 1315 334 036</p> <p><b>EX / CROSS :</b></p>	<p><b>Packaging Unit:</b> 1</p> <p><b>Model:</b></p>																								
<p><b>T94436</b></p> 	<p><b>Description:</b> CYLINDER REPAIR KIT AS-TRONIC</p> <p><b>OEM No :</b> 0501 324 254</p> <p><b>EX / CROSS :</b></p>	<p><b>Packaging Unit:</b> 1</p> <p><b>Model:</b></p> <table border="0"> <tr> <td>10AS 2010B IT</td> <td>12AS 1935TD</td> </tr> <tr> <td>10AS 2300BO</td> <td>12AS 2000B IT</td> </tr> <tr> <td>10AS 2310B</td> <td>12AS 2000BO</td> </tr> <tr> <td>10AS 2310B IT</td> <td>12AS 2001BO IT</td> </tr> <tr> <td>10AS 2700BO</td> <td>12AS 2130TD</td> </tr> <tr> <td>12AS 1601BO IT</td> <td>12AS 2130TO</td> </tr> <tr> <td>12AS 1630TD</td> <td>12AS 2131TD IT</td> </tr> <tr> <td>12AS 1631TD IT</td> <td>12AS 2131TO IT</td> </tr> <tr> <td>12AS 1930TD</td> <td>12AS 2300B IT</td> </tr> <tr> <td>12AS 1930TO</td> <td>12AS 2300BO</td> </tr> <tr> <td>12AS 1931TD IT</td> <td>12AS 2301</td> </tr> <tr> <td>12AS 1931TO IT</td> <td>12AS 2301BO IT</td> </tr> </table>	10AS 2010B IT	12AS 1935TD	10AS 2300BO	12AS 2000B IT	10AS 2310B	12AS 2000BO	10AS 2310B IT	12AS 2001BO IT	10AS 2700BO	12AS 2130TD	12AS 1601BO IT	12AS 2130TO	12AS 1630TD	12AS 2131TD IT	12AS 1631TD IT	12AS 2131TO IT	12AS 1930TD	12AS 2300B IT	12AS 1930TO	12AS 2300BO	12AS 1931TD IT	12AS 2301	12AS 1931TO IT	12AS 2301BO IT
10AS 2010B IT	12AS 1935TD																									
10AS 2300BO	12AS 2000B IT																									
10AS 2310B	12AS 2000BO																									
10AS 2310B IT	12AS 2001BO IT																									
10AS 2700BO	12AS 2130TD																									
12AS 1601BO IT	12AS 2130TO																									
12AS 1630TD	12AS 2131TD IT																									
12AS 1631TD IT	12AS 2131TO IT																									
12AS 1930TD	12AS 2300B IT																									
12AS 1930TO	12AS 2300BO																									
12AS 1931TD IT	12AS 2301																									
12AS 1931TO IT	12AS 2301BO IT																									
<p><b>T38025</b></p> 	<p><b>Description:</b> CYLINDRICAL ROLLER BEARING (30X23)</p> <p><b>OEM No :</b> 0750 118 010</p> <p><b>EX / CROSS :</b> 87486 0735 455 018 0735 455 023</p>	<p><b>Packaging Unit:</b> 1</p> <p><b>Model:</b></p> <table border="0"> <tr> <td>16K 130</td> </tr> <tr> <td>16S 112</td> </tr> <tr> <td>16S 112/1</td> </tr> <tr> <td>16S 130</td> </tr> <tr> <td>16S 130/1</td> </tr> </table>	16K 130	16S 112	16S 112/1	16S 130	16S 130/1																			
16K 130																										
16S 112																										
16S 112/1																										
16S 130																										
16S 130/1																										

<p><b>T47477</b></p> 	<p><b>Description:</b> CYLINDRICAL ROLLER BEARING (30X26)</p> <p><b>Packaging Unit:</b> 1</p> <table border="0"> <tr> <td><b>OEM No :</b></td> <td><b>Model:</b></td> <td></td> </tr> <tr> <td>0750 118 019</td> <td>4S 120GP</td> <td>5S 110GPA+GV90</td> </tr> <tr> <td></td> <td>5K 110GP</td> <td>5S 111GP</td> </tr> <tr> <td></td> <td>5K 110GP+GV90</td> <td>5S 111GP+GV90</td> </tr> <tr> <td><b>EX / CROSS :</b></td> <td>5K 110GPA</td> <td>5S 111GPA</td> </tr> <tr> <td>512533</td> <td>5K 110GPA+GV90</td> <td>5S 90GP</td> </tr> <tr> <td>F-87629</td> <td>5K 90GP</td> <td>5S 90GPA</td> </tr> <tr> <td></td> <td>5K 90GPA</td> <td>5S 92GP</td> </tr> <tr> <td>0735 455 004</td> <td>5K 91GP</td> <td>S4 90</td> </tr> <tr> <td></td> <td>5K 91GPA</td> <td>S5 50</td> </tr> <tr> <td>0735 455 019</td> <td>5S 110GP</td> <td></td> </tr> <tr> <td></td> <td>5S 110GP+GV90</td> <td></td> </tr> <tr> <td></td> <td>5S 110GPA</td> <td></td> </tr> </table>	<b>OEM No :</b>	<b>Model:</b>		0750 118 019	4S 120GP	5S 110GPA+GV90		5K 110GP	5S 111GP		5K 110GP+GV90	5S 111GP+GV90	<b>EX / CROSS :</b>	5K 110GPA	5S 111GPA	512533	5K 110GPA+GV90	5S 90GP	F-87629	5K 90GP	5S 90GPA		5K 90GPA	5S 92GP	0735 455 004	5K 91GP	S4 90		5K 91GPA	S5 50	0735 455 019	5S 110GP			5S 110GP+GV90			5S 110GPA	
<b>OEM No :</b>	<b>Model:</b>																																							
0750 118 019	4S 120GP	5S 110GPA+GV90																																						
	5K 110GP	5S 111GP																																						
	5K 110GP+GV90	5S 111GP+GV90																																						
<b>EX / CROSS :</b>	5K 110GPA	5S 111GPA																																						
512533	5K 110GPA+GV90	5S 90GP																																						
F-87629	5K 90GP	5S 90GPA																																						
	5K 90GPA	5S 92GP																																						
0735 455 004	5K 91GP	S4 90																																						
	5K 91GPA	S5 50																																						
0735 455 019	5S 110GP																																							
	5S 110GP+GV90																																							
	5S 110GPA																																							
<p><b>T38014</b></p> 	<p><b>Description:</b> CYLINDRICAL ROLLER BEARING (35X25)</p> <p><b>Packaging Unit:</b> 1</p> <table border="0"> <tr> <td><b>OEM No :</b></td> <td><b>Model:</b></td> <td></td> </tr> <tr> <td>0750 118 038</td> <td>16K 160</td> <td>16S 190A</td> </tr> <tr> <td></td> <td>16K 190</td> <td>16S 190A/1</td> </tr> <tr> <td></td> <td>16S 160</td> <td>16S 200</td> </tr> <tr> <td><b>EX / CROSS :</b></td> <td>16S 160/1</td> <td>8S 1350 KMZ</td> </tr> <tr> <td>F 88545</td> <td>16S 1600</td> <td>8S 190</td> </tr> <tr> <td></td> <td>16S 160A</td> <td></td> </tr> <tr> <td>0735 455 040</td> <td>16S 160A/1</td> <td></td> </tr> <tr> <td></td> <td>16S 1650</td> <td></td> </tr> <tr> <td>0750 118 008</td> <td>16S 1650 IVE</td> <td></td> </tr> <tr> <td></td> <td>16S 190</td> <td></td> </tr> <tr> <td></td> <td>16S 190/1</td> <td></td> </tr> <tr> <td></td> <td>16S 1900</td> <td></td> </tr> </table>	<b>OEM No :</b>	<b>Model:</b>		0750 118 038	16K 160	16S 190A		16K 190	16S 190A/1		16S 160	16S 200	<b>EX / CROSS :</b>	16S 160/1	8S 1350 KMZ	F 88545	16S 1600	8S 190		16S 160A		0735 455 040	16S 160A/1			16S 1650		0750 118 008	16S 1650 IVE			16S 190			16S 190/1			16S 1900	
<b>OEM No :</b>	<b>Model:</b>																																							
0750 118 038	16K 160	16S 190A																																						
	16K 190	16S 190A/1																																						
	16S 160	16S 200																																						
<b>EX / CROSS :</b>	16S 160/1	8S 1350 KMZ																																						
F 88545	16S 1600	8S 190																																						
	16S 160A																																							
0735 455 040	16S 160A/1																																							
	16S 1650																																							
0750 118 008	16S 1650 IVE																																							
	16S 190																																							
	16S 190/1																																							
	16S 1900																																							
<p><b>T54650</b></p> 	<p><b>Description:</b> CYLINDRICAL ROLLER BEARING (50X110X27)</p> <p><b>Packaging Unit:</b> 1</p> <table border="0"> <tr> <td><b>OEM No :</b></td> <td><b>Model:</b></td> </tr> <tr> <td>0501 398 245</td> <td>S5 680 SSO</td> </tr> <tr> <td><b>EX / CROSS :</b></td> <td></td> </tr> <tr> <td>0501 398 216</td> <td></td> </tr> </table>	<b>OEM No :</b>	<b>Model:</b>	0501 398 245	S5 680 SSO	<b>EX / CROSS :</b>		0501 398 216																																
<b>OEM No :</b>	<b>Model:</b>																																							
0501 398 245	S5 680 SSO																																							
<b>EX / CROSS :</b>																																								
0501 398 216																																								
<p><b>T54646</b></p> 	<p><b>Description:</b> CYLINDRICAL ROLLER BEARING (60X110X28)</p> <p><b>Packaging Unit:</b> 1</p> <table border="0"> <tr> <td><b>OEM No :</b></td> <td><b>Model:</b></td> </tr> <tr> <td>0501 398 244</td> <td>S5 680</td> </tr> <tr> <td><b>EX / CROSS :</b></td> <td></td> </tr> </table>	<b>OEM No :</b>	<b>Model:</b>	0501 398 244	S5 680	<b>EX / CROSS :</b>																																		
<b>OEM No :</b>	<b>Model:</b>																																							
0501 398 244	S5 680																																							
<b>EX / CROSS :</b>																																								
<p><b>T38154</b></p> 	<p><b>Description:</b> CYLINDRICAL ROLLER BEARING (60X130X31)</p> <p><b>Packaging Unit:</b> 1</p> <table border="0"> <tr> <td><b>OEM No :</b></td> <td><b>Model:</b></td> </tr> <tr> <td>0750 118 153</td> <td>16K 130</td> </tr> <tr> <td></td> <td>16K 160</td> </tr> <tr> <td></td> <td>16K 190</td> </tr> <tr> <td><b>EX / CROSS :</b></td> <td>16S 112</td> </tr> <tr> <td>540106</td> <td>16S 112/1</td> </tr> <tr> <td>635245</td> <td>16S 130</td> </tr> <tr> <td>0501 398 348</td> <td>16S 130</td> </tr> <tr> <td>0501 398 349</td> <td>16S 130/1</td> </tr> <tr> <td></td> <td>8S 1350 KMZ</td> </tr> </table>	<b>OEM No :</b>	<b>Model:</b>	0750 118 153	16K 130		16K 160		16K 190	<b>EX / CROSS :</b>	16S 112	540106	16S 112/1	635245	16S 130	0501 398 348	16S 130	0501 398 349	16S 130/1		8S 1350 KMZ																			
<b>OEM No :</b>	<b>Model:</b>																																							
0750 118 153	16K 130																																							
	16K 160																																							
	16K 190																																							
<b>EX / CROSS :</b>	16S 112																																							
540106	16S 112/1																																							
635245	16S 130																																							
0501 398 348	16S 130																																							
0501 398 349	16S 130/1																																							
	8S 1350 KMZ																																							

<p><b>T37993</b></p> 	<p><b>Description:</b> CYLINDRICAL ROLLER BEARING (63X37,5)</p> <p><b>Packaging Unit:</b> 1</p> <p><b>OEM No :</b> 0750 118 220</p> <p><b>EX / CROSS :</b> F 88816.2 0735 455 248 0750 118 030</p> <p><b>Model:</b> 16S 160 16S 160/1 16S 1600 16S 160A 16S 160A/1 16S 190 16S 190/1 16S 1900 16S 190A 16S 190A/1 16S 200 8S 190</p>
<p><b>T38006</b></p> 	<p><b>Description:</b> CYLINDRICAL ROLLER BEARING (63X97,5X34,8)</p> <p><b>Packaging Unit:</b> 1</p> <p><b>OEM No :</b> 0750 118 005</p> <p><b>EX / CROSS :</b> F 90836.1A 0735 455 062 0735 455 101 0735 455 114</p> <p><b>Model:</b> 16K 160 16K 190 16S 130 16S 130/1 16S 1300 16S 1650 16S 1650 MAZ</p>
<p><b>T22335</b></p> 	<p><b>Description:</b> CYLINDRICAL ROLLER BEARING (67X32)</p> <p><b>Packaging Unit:</b> 1</p> <p><b>OEM No :</b> 0750 118 198</p> <p><b>EX / CROSS :</b> F-211413.02 VKT 8906 0735 410 319 0735 410 327</p> <p><b>Model:</b> 16S 150 16S 151 Ecosplit III</p>
<p><b>T38047</b></p> 	<p><b>Description:</b> CYLINDRICAL ROLLER BEARING (67X38)</p> <p><b>Packaging Unit:</b> 1</p> <p><b>OEM No :</b> 0750 118 258</p> <p><b>EX / CROSS :</b> F-211408.05 0750 118 191</p> <p><b>Model:</b> 16S 220 16S 220A 16S 221 Ecosplit III</p>
<p><b>T38034</b></p> 	<p><b>Description:</b> CYLINDRICAL ROLLER BEARING (70X150X35)</p> <p><b>Packaging Unit:</b> 1</p> <p><b>OEM No :</b> 0750 118 082</p> <p><b>EX / CROSS :</b> 0750 118 077</p> <p><b>Model:</b> 4S 150GP 4S 150GP+400 AK6 80 AK6 80+GV80 AK6 90 AK6 90+GV90 S6 1550 S6 80 S6 80+GV80 S6 80/1 S6 80/1+GV80 S6 90 S6 90 SETRA S6 90+GV90 S6 90+GV90 SNVI S6 90/1 S6 90/1+GV90</p>



**T50168**



**Description:**

CYLINDRICAL ROLLER BEARING (77X101X29)

**Packaging Unit:** 1

**OEM No :**

0750 115 534

**Model:**

12S 2130TD  
12S 2131TD IT  
12S 2133TD  
12S 2330TD  
12S 2331TD IT  
12S 2333TD  
12S 2333TD IT  
12S 2830TD  
12S 2831TD IT  
12S 2833TD  
12S 2833TD IT  
16S 1685

16S 181  
16S 182  
16S 1920TD  
16S 1921TD IT  
16S 1922TD  
16S 1923TD  
16S 1925TD  
16S 1930TD  
16S 1931TD IT  
16S 1933TD  
16S 1935TD  
16S 193TD IT

**EX / CROSS :**

0750 115 531

0735 358 313

**T23890**



**Description:**

CYLINDRICAL ROLLER BEARING (80X150X28)

**Packaging Unit:** 1

**OEM No :**

0750 118 131

**Model:**

16K 130  
16K 160  
16K 190  
16S 112  
16S 112/1  
16S 130  
16S 130/1  
16S 160  
16S 160/1  
16S 160A  
16S 1650  
16S 190

16S 190/1  
16S 190A  
16S 200  
8S 190

**EX / CROSS :**

566616 B

BC1B 319552

0735 410 051

0735 410 238

**T18571**



**Description:**

DIFF. CARRIER GEAR (34T.)

**Packaging Unit:** 1

**OEM No :**

0095 353 232

**Model:**

**EX / CROSS :**

4472 353 098

4472 353 463

4472 353 600

**T15631**



**Description:**

DIFF. GEAR AND PINION (13-46)

**Packaging Unit:** 1

**OEM No :**

4415 201 155

**Model:**

**EX / CROSS :**

4415 201 145

**T15924**



**Description:**

DIFF. GEAR AND PINION (13-46)

**Packaging Unit:** 1

**OEM No :**





4460 291 365

**Model:**

**EX / CROSS :**

4460 291 336

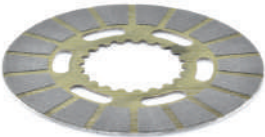
<p><b>T15918</b></p> 	<p><b>Description:</b> DIFF. GEAR KIT</p> <p><b>OEM No :</b> (KIT-R9)</p> <p><b>EX / CROSS :</b></p>	<p><b>Packaging Unit:</b> 1</p> <p><b>Model:</b></p>
<p><b>T15919</b></p> 	<p><b>Description:</b> DIFF. GEAR KIT</p> <p><b>OEM No :</b> (KIT-S9)</p> <p><b>EX / CROSS :</b></p>	<p><b>Packaging Unit:</b> 1</p> <p><b>Model:</b></p>
<p><b>T15926</b></p> 	<p><b>Description:</b> DIFF. PINION GEAR (9T.)</p> <p><b>OEM No :</b> 4461 391 018</p> <p><b>EX / CROSS :</b> 4461 331 008</p>	<p><b>Packaging Unit:</b> 4</p> <p><b>Model:</b></p>
<p><b>T18807</b></p> 	<p><b>Description:</b> DIFF. RING GEAR (90T.-51SPL.)</p> <p><b>OEM No :</b> 4472 353 419</p> <p><b>EX / CROSS :</b></p>	<p><b>Packaging Unit:</b> 1</p> <p><b>Model:</b> APL 335 / 340 / 345 / 350 AS 3045 / 3050</p>
<p><b>T15923</b></p> 	<p><b>Description:</b> DIFF. SIDE GEAR (16T.-29SPL.)</p> <p><b>OEM No :</b> 4415 301 416</p> <p><b>EX / CROSS :</b></p>	<p><b>Packaging Unit:</b> 1</p> <p><b>Model:</b></p>

<p><b>T15929</b></p> 	<p><b>Description:</b> DIFF. SPIDER</p> <p><b>Packaging Unit:</b> 1</p> <p><b>OEM No :</b> 4461 391 021</p> <p><b>Model:</b></p> <p><b>EX / CROSS :</b> 4461 391 029 4415 301 356</p>
<p><b>T60646</b></p> 	<p><b>Description:</b> DISC</p> <p><b>Packaging Unit:</b> 1</p> <p><b>OEM No :</b> 0501 214 821</p> <p><b>Model:</b> 10AS 2010B IT 10AS 2300BO 10AS 2310B 10AS 2310B IT 10AS 2700BO 12AS 1601BO IT 12AS 1630TD 12AS 1631TD IT 12AS 1930TD 12AS 1930TO 12AS 1931TD IT 12AS 1931TO IT</p> <p><b>EX / CROSS :</b> 0501 211 617 0501 212 367</p> <p>12AS 1935TD 12AS 2000B IT 12AS 2000BO 12AS 2001BO IT 12AS 2130TD 12AS 2130TO 12AS 2131TD IT 12AS 2131TO IT 12AS 2300B IT 12AS 2300BO 12AS 2301 12AS 2301BO IT</p>
<p><b>T60576</b></p> 	<p><b>Description:</b> DISC</p> <p><b>Packaging Unit:</b> 1</p> <p><b>OEM No :</b> 1328 302 024</p> <p><b>Model:</b> 10AS 2010B IT 10AS 2300BO 10AS 2310B 10AS 2310B IT 10AS 2700BO 12AS 1601BO IT 12AS 1630TD 12AS 1631TD IT 12AS 1930TD 12AS 1930TO 12AS 1931TD IT 12AS 1931TO IT</p> <p><b>EX / CROSS :</b></p> <p>12AS 1935TD 12AS 2000B IT 12AS 2000BO 12AS 2001BO IT 12AS 2130TD 12AS 2130TO 12AS 2131TD IT 12AS 2131TO IT 12AS 2140TD 12AS 2300B IT 12AS 2300BO 12AS 2301 12AS 2301BO IT</p>
<p><b>T57536</b></p> 	<p><b>Description:</b> DISC</p> <p><b>Packaging Unit:</b> 1</p> <p><b>OEM No :</b> 0501 214 822</p> <p><b>Model:</b> 12AS 1800 12AS 1800IT 12AS 2140TD 12AS 2340TD 12AS 2341TD IT 12AS 2540TD 12AS 2540TO 12AS 2541TD IT 12AS 2541TO IT 12AS 2740TO 12AS 2741TO IT 12AS 2940TO</p> <p><b>EX / CROSS :</b> 0501 211 493 0501 211 618</p> <p>12AS 2941TO IT 12AS 3000TD 12AS 3000TD IT 12AS 3000TO 12AS 3000TO IT 12AS 3001 12AS 3001IT 12AS 3140TO 12AS 3141TO IT 16AS 2200TD 16AS 2200TD IT 16AS 2230TD</p>
<p><b>T79150</b></p> 	<p><b>Description:</b> DISC</p> <p><b>Packaging Unit:</b> 1</p> <p><b>OEM No :</b> 0501 219 105</p> <p><b>Model:</b> 12 TX 1410 TD IT (1372 001 023) 12 TX 1410 TD IT (1372 001 030) 12 TX 1410 TO (1372 002 019) 12 TX 1411 TD IT (1372 040 027) 12 TX 1411 TD IT (1372 040 028) 12 TX 1411 TD IT (1372 040 029) 12 TX 1411 TO IT (1372 041 017) 12 TX 1611 BO IT (1372 044 050) 12 TX 1611 BO IT (1372 044 051) 12 TX 1611 BO IT (1372 044 071) 12 TX 1611 BO IT (1372 044 075) 12 TX 1611 TO IT (1372 041 015) 12 TX 1611 TO IT (1372 041 016) 12 TX 1810 TD IT (1372 001 024)</p> <p><b>EX / CROSS :</b></p>

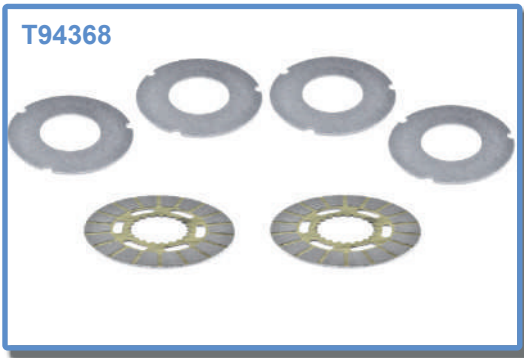

**Description:**  
DISC KIT FOR AS-TRONIC

**Packaging Unit:** 1

**OEM No :**  
TAS94368

**Model:**

12AS 1800  
12AS 1800IT  
12AS 2140TD  
12AS 2340TD  
12AS 2341TD IT  
12AS 2540TD  
12AS 2540TO  
12AS 2541TD IT  
12AS 2541TO IT  
12AS 2740TO  
12AS 2741TO IT  
12AS 2940TO

12AS 2941TO IT  
12AS 3000TD  
12AS 3000TD IT  
12AS 3000TO  
12AS 3000TO IT  
12AS 3001  
12AS 3001IT  
12AS 3140TO  
12AS 3141TO IT  
16AS 2200TD  
16AS 2200TD IT  
16AS 2230TD

**EX / CROSS :**



**Description:**  
DISC KIT FOR AS-TRONIC

**Packaging Unit:** 1

**OEM No :**  
TAS78683

**Model:**

**EX / CROSS :**



**Description:**  
DRIVER

**Packaging Unit:** 1

**OEM No :**  
1272 307 025

**Model:**

**EX / CROSS :**



**Description:**  
DRIVER

**Packaging Unit:** 1

**OEM No :**  
1269 307 629

**Model:**

**EX / CROSS :**



**Description:**  
DRIVER





**Packaging Unit:** 1

**OEM No :**  
1269 307 294

**Model:**





**EX / CROSS :**







<p><b>T43979</b></p> 	<p><b>Description:</b> ELASTIC PIN (Ø3,5X26)</p> <p><b>OEM No :</b> 0631 329 261</p> <p><b>EX / CROSS :</b></p>	<p><b>Packaging Unit:</b> 5</p> <p><b>Model:</b></p> <table border="0"> <tr><td>12S 2130TD</td><td>16S 1621TD IT</td></tr> <tr><td>12S 2131TD IT</td><td>16S 1625TD</td></tr> <tr><td>12S 2133TD</td><td>16S 162TD IT</td></tr> <tr><td>12S 2330TD</td><td>16S 1630TD</td></tr> <tr><td>12S 2331TD IT</td><td>16S 1631TD IT</td></tr> <tr><td>12S 2333TD</td><td>16S 1635TD</td></tr> <tr><td>12S 233TD IT</td><td>16S 163TD IT</td></tr> <tr><td>12S 2831TD IT</td><td>16S 1685</td></tr> <tr><td>12S 2833TD</td><td>16S 181</td></tr> <tr><td>12S 283TD IT</td><td>16S 182</td></tr> <tr><td>16S 151</td><td>16S 1820TO</td></tr> <tr><td>16S 1620TD</td><td>16S 1820TO RVI</td></tr> </table>	12S 2130TD	16S 1621TD IT	12S 2131TD IT	16S 1625TD	12S 2133TD	16S 162TD IT	12S 2330TD	16S 1630TD	12S 2331TD IT	16S 1631TD IT	12S 2333TD	16S 1635TD	12S 233TD IT	16S 163TD IT	12S 2831TD IT	16S 1685	12S 2833TD	16S 181	12S 283TD IT	16S 182	16S 151	16S 1820TO	16S 1620TD	16S 1820TO RVI
12S 2130TD	16S 1621TD IT																									
12S 2131TD IT	16S 1625TD																									
12S 2133TD	16S 162TD IT																									
12S 2330TD	16S 1630TD																									
12S 2331TD IT	16S 1631TD IT																									
12S 2333TD	16S 1635TD																									
12S 233TD IT	16S 163TD IT																									
12S 2831TD IT	16S 1685																									
12S 2833TD	16S 181																									
12S 283TD IT	16S 182																									
16S 151	16S 1820TO																									
16S 1620TD	16S 1820TO RVI																									
<p><b>T09037</b></p> 	<p><b>Description:</b> ELASTIC PIN (Ø3X20)</p> <p><b>OEM No :</b> 0631 329 016</p> <p><b>EX / CROSS :</b></p>	<p><b>Packaging Unit:</b> 5</p> <p><b>Model:</b></p>																								
<p><b>T15771</b></p> 	<p><b>Description:</b> ELASTIC PIN (Ø3X24)</p> <p><b>OEM No :</b> 0631 329 017</p> <p><b>EX / CROSS :</b></p>	<p><b>Packaging Unit:</b> 5</p> <p><b>Model:</b></p>																								
<p><b>T37830</b></p> 	<p><b>Description:</b> ELASTIC PIN (Ø3X26)</p> <p><b>OEM No :</b> 0631 329 167</p> <p><b>EX / CROSS :</b> 0631 329 018</p>	<p><b>Packaging Unit:</b> 5</p> <p><b>Model:</b></p> <table border="0"> <tr><td>12S 2830TD</td><td>16S 1620TD</td></tr> <tr><td>16S 150</td><td>16S 1621TD IT</td></tr> <tr><td>16S 151</td><td>16S 1625TD</td></tr> <tr><td>16S 151 DAF</td><td>16S 162TD IT</td></tr> <tr><td>16S 151 HIN</td><td>16S 181</td></tr> <tr><td>16S 151 HYU</td><td>16S 181 IVE</td></tr> <tr><td>16S 151 IVE</td><td>16S 181 MAN</td></tr> <tr><td>16S 151 KMZ</td><td>16S 181 RVI</td></tr> <tr><td>16S 151 MAN</td><td>16S 181IT DAF</td></tr> <tr><td>16S 151 RVI</td><td>16S 182</td></tr> <tr><td>16S 151 SNVI</td><td>16S 1820TO</td></tr> <tr><td>16S 151IT DAF</td><td>16S 1820TO KMZ</td></tr> </table>	12S 2830TD	16S 1620TD	16S 150	16S 1621TD IT	16S 151	16S 1625TD	16S 151 DAF	16S 162TD IT	16S 151 HIN	16S 181	16S 151 HYU	16S 181 IVE	16S 151 IVE	16S 181 MAN	16S 151 KMZ	16S 181 RVI	16S 151 MAN	16S 181IT DAF	16S 151 RVI	16S 182	16S 151 SNVI	16S 1820TO	16S 151IT DAF	16S 1820TO KMZ
12S 2830TD	16S 1620TD																									
16S 150	16S 1621TD IT																									
16S 151	16S 1625TD																									
16S 151 DAF	16S 162TD IT																									
16S 151 HIN	16S 181																									
16S 151 HYU	16S 181 IVE																									
16S 151 IVE	16S 181 MAN																									
16S 151 KMZ	16S 181 RVI																									
16S 151 MAN	16S 181IT DAF																									
16S 151 RVI	16S 182																									
16S 151 SNVI	16S 1820TO																									
16S 151IT DAF	16S 1820TO KMZ																									
<p><b>T73652</b></p> 	<p><b>Description:</b> ELASTIC PIN (Ø4,70X23,5)</p> <p><b>OEM No :</b> 1358 332 015</p> <p><b>EX / CROSS :</b></p>	<p><b>Packaging Unit:</b></p> <p><b>Model:</b></p> <table border="0"> <tr><td>12 TX 1410 TD IT (1372 001 023)</td><td>12 TX 1611 BO IT (1372 044 050)</td></tr> <tr><td>12 TX 1410 TD IT (1372 001 030)</td><td>12 TX 1611 BO IT (1372 044 051)</td></tr> <tr><td>12 TX 1410 TO (1372 002 019)</td><td>12 TX 1611 BO IT (1372 044 071)</td></tr> <tr><td>12 TX 1411 TD IT (1372 040 027)</td><td>12 TX 1611 BO IT (1372 044 075)</td></tr> <tr><td>12 TX 1411 TD IT (1372 040 028)</td><td>12 TX 1611 TO IT (1372 041 015)</td></tr> <tr><td>12 TX 1411 TD IT (1372 040 029)</td><td>12 TX 1611 TO IT (1372 041 016)</td></tr> <tr><td>12 TX 1411 TO IT (1372 041 017)</td><td>12 TX 1810 TD IT (1372 001 024)</td></tr> </table>	12 TX 1410 TD IT (1372 001 023)	12 TX 1611 BO IT (1372 044 050)	12 TX 1410 TD IT (1372 001 030)	12 TX 1611 BO IT (1372 044 051)	12 TX 1410 TO (1372 002 019)	12 TX 1611 BO IT (1372 044 071)	12 TX 1411 TD IT (1372 040 027)	12 TX 1611 BO IT (1372 044 075)	12 TX 1411 TD IT (1372 040 028)	12 TX 1611 TO IT (1372 041 015)	12 TX 1411 TD IT (1372 040 029)	12 TX 1611 TO IT (1372 041 016)	12 TX 1411 TO IT (1372 041 017)	12 TX 1810 TD IT (1372 001 024)										
12 TX 1410 TD IT (1372 001 023)	12 TX 1611 BO IT (1372 044 050)																									
12 TX 1410 TD IT (1372 001 030)	12 TX 1611 BO IT (1372 044 051)																									
12 TX 1410 TO (1372 002 019)	12 TX 1611 BO IT (1372 044 071)																									
12 TX 1411 TD IT (1372 040 027)	12 TX 1611 BO IT (1372 044 075)																									
12 TX 1411 TD IT (1372 040 028)	12 TX 1611 TO IT (1372 041 015)																									
12 TX 1411 TD IT (1372 040 029)	12 TX 1611 TO IT (1372 041 016)																									
12 TX 1411 TO IT (1372 041 017)	12 TX 1810 TD IT (1372 001 024)																									





<p><b>T09038</b></p> 	<p><b>Description:</b> ELASTIC PIN (Ø5X20)</p> <p><b>OEM No :</b> 0631 329 048</p> <p><b>EX / CROSS :</b> 0501 315 917 0000 104 578</p>	<p><b>Packaging Unit:</b> 5</p> <p><b>Model:</b></p>																								
<p><b>T15775</b></p> 	<p><b>Description:</b> ELASTIC PIN (Ø5X24)</p> <p><b>OEM No :</b> 0631 329 050</p> <p><b>EX / CROSS :</b></p>	<p><b>Packaging Unit:</b> 5</p> <p><b>Model:</b></p>																								
<p><b>T37822</b></p> 	<p><b>Description:</b> ELASTIC PIN (Ø5X26)</p> <p><b>OEM No :</b> 0631 329 052</p> <p><b>EX / CROSS :</b> 0631 329 051</p>	<p><b>Packaging Unit:</b> 5</p> <p><b>Model:</b></p> <table border="0"> <tr> <td>12S 2830TD</td> <td>16S 1620TD</td> </tr> <tr> <td>16S 150</td> <td>16S 1621TD IT</td> </tr> <tr> <td>16S 151</td> <td>16S 1625TD</td> </tr> <tr> <td>16S 151 DAF</td> <td>16S 162TD IT</td> </tr> <tr> <td>16S 151 HIN</td> <td>16S 181</td> </tr> <tr> <td>16S 151 HYU</td> <td>16S 181 IVE</td> </tr> <tr> <td>16S 151 IVE</td> <td>16S 181 MAN</td> </tr> <tr> <td>16S 151 KMZ</td> <td>16S 181 RVI</td> </tr> <tr> <td>16S 151 MAN</td> <td>16S 181IT DAF</td> </tr> <tr> <td>16S 151 RVI</td> <td>16S 182</td> </tr> <tr> <td>16S 151 SNVI</td> <td>16S 1820TO</td> </tr> <tr> <td>16S 151IT DAF</td> <td>16S 1820TO KMZ</td> </tr> </table>	12S 2830TD	16S 1620TD	16S 150	16S 1621TD IT	16S 151	16S 1625TD	16S 151 DAF	16S 162TD IT	16S 151 HIN	16S 181	16S 151 HYU	16S 181 IVE	16S 151 IVE	16S 181 MAN	16S 151 KMZ	16S 181 RVI	16S 151 MAN	16S 181IT DAF	16S 151 RVI	16S 182	16S 151 SNVI	16S 1820TO	16S 151IT DAF	16S 1820TO KMZ
12S 2830TD	16S 1620TD																									
16S 150	16S 1621TD IT																									
16S 151	16S 1625TD																									
16S 151 DAF	16S 162TD IT																									
16S 151 HIN	16S 181																									
16S 151 HYU	16S 181 IVE																									
16S 151 IVE	16S 181 MAN																									
16S 151 KMZ	16S 181 RVI																									
16S 151 MAN	16S 181IT DAF																									
16S 151 RVI	16S 182																									
16S 151 SNVI	16S 1820TO																									
16S 151IT DAF	16S 1820TO KMZ																									
<p><b>T43978</b></p> 	<p><b>Description:</b> ELASTIC PIN (Ø6X26)</p> <p><b>OEM No :</b> 0631 329 147</p> <p><b>EX / CROSS :</b></p>	<p><b>Packaging Unit:</b> 5</p> <p><b>Model:</b></p> <table border="0"> <tr> <td>12S 2130TD</td> <td>16S 1621TD IT</td> </tr> <tr> <td>12S 2131TD IT</td> <td>16S 1625TD</td> </tr> <tr> <td>12S 2133TD</td> <td>16S 162TD IT</td> </tr> <tr> <td>12S 2330TD</td> <td>16S 1630TD</td> </tr> <tr> <td>12S 2331TD IT</td> <td>16S 1631TD IT</td> </tr> <tr> <td>12S 2333TD</td> <td>16S 1635TD</td> </tr> <tr> <td>12S 233TD IT</td> <td>16S 163TD IT</td> </tr> <tr> <td>12S 2831TD IT</td> <td>16S 1685</td> </tr> <tr> <td>12S 2833TD</td> <td>16S 181</td> </tr> <tr> <td>12S 283TD IT</td> <td>16S 182</td> </tr> <tr> <td>16S 151</td> <td>16S 1820TO</td> </tr> <tr> <td>16S 1620TD</td> <td>16S 1820TO RVI</td> </tr> </table>	12S 2130TD	16S 1621TD IT	12S 2131TD IT	16S 1625TD	12S 2133TD	16S 162TD IT	12S 2330TD	16S 1630TD	12S 2331TD IT	16S 1631TD IT	12S 2333TD	16S 1635TD	12S 233TD IT	16S 163TD IT	12S 2831TD IT	16S 1685	12S 2833TD	16S 181	12S 283TD IT	16S 182	16S 151	16S 1820TO	16S 1620TD	16S 1820TO RVI
12S 2130TD	16S 1621TD IT																									
12S 2131TD IT	16S 1625TD																									
12S 2133TD	16S 162TD IT																									
12S 2330TD	16S 1630TD																									
12S 2331TD IT	16S 1631TD IT																									
12S 2333TD	16S 1635TD																									
12S 233TD IT	16S 163TD IT																									
12S 2831TD IT	16S 1685																									
12S 2833TD	16S 181																									
12S 283TD IT	16S 182																									
16S 151	16S 1820TO																									
16S 1620TD	16S 1820TO RVI																									
<p><b>T57480</b></p> 	<p><b>Description:</b> ELASTIC RING</p> <p><b>OEM No :</b> TAS57480</p> <p><b>EX / CROSS :</b></p>	<p><b>Packaging Unit:</b> 1</p> <p><b>Model:</b></p>																								

<p><b>T39110</b></p> 	<p><b>Description:</b> ELASTIC RING (T.3,00)</p> <p><b>OEM No :</b> 0730 007 747</p> <p><b>EX / CROSS :</b> 0501 398 752</p>	<p><b>Packaging Unit:</b> 1</p> <p><b>Model:</b></p> <table border="0"> <tr><td>16S 151</td><td>16S 181 RVI</td></tr> <tr><td>16S 151 DAF</td><td>16S 181IT DAF</td></tr> <tr><td>16S 151 HIN</td><td>16S 221</td></tr> <tr><td>16S 151 HYU</td><td>16S 221 DAF</td></tr> <tr><td>16S 151 KMZ</td><td>16S 221 IVE</td></tr> <tr><td>16S 151 MAN</td><td>16S 221 MAN</td></tr> <tr><td>16S 151 RVI</td><td>16S 221 MB</td></tr> <tr><td>16S 151 SNVI</td><td>16S 221 RVI</td></tr> <tr><td>16S 151IT DAF</td><td>16S 221IT RVI</td></tr> <tr><td>16S 181</td><td>16S 251 NIS</td></tr> <tr><td>16S 181 IVE</td><td>Ecosplit III</td></tr> <tr><td>16S 181 MAN</td><td></td></tr> </table>	16S 151	16S 181 RVI	16S 151 DAF	16S 181IT DAF	16S 151 HIN	16S 221	16S 151 HYU	16S 221 DAF	16S 151 KMZ	16S 221 IVE	16S 151 MAN	16S 221 MAN	16S 151 RVI	16S 221 MB	16S 151 SNVI	16S 221 RVI	16S 151IT DAF	16S 221IT RVI	16S 181	16S 251 NIS	16S 181 IVE	Ecosplit III	16S 181 MAN					
16S 151	16S 181 RVI																													
16S 151 DAF	16S 181IT DAF																													
16S 151 HIN	16S 221																													
16S 151 HYU	16S 221 DAF																													
16S 151 KMZ	16S 221 IVE																													
16S 151 MAN	16S 221 MAN																													
16S 151 RVI	16S 221 MB																													
16S 151 SNVI	16S 221 RVI																													
16S 151IT DAF	16S 221IT RVI																													
16S 181	16S 251 NIS																													
16S 181 IVE	Ecosplit III																													
16S 181 MAN																														
<p><b>T39108</b></p> 	<p><b>Description:</b> ELASTIC RING (T.3,50)</p> <p><b>OEM No :</b> 0730 006 171</p> <p><b>EX / CROSS :</b></p>	<p><b>Packaging Unit:</b> 5</p> <p><b>Model:</b></p> <table border="0"> <tr><td>16S 151</td><td>16S 181 RVI</td></tr> <tr><td>16S 151 DAF</td><td>16S 181IT DAF</td></tr> <tr><td>16S 151 HIN</td><td>16S 221</td></tr> <tr><td>16S 151 HYU</td><td>16S 221 DAF</td></tr> <tr><td>16S 151 KMZ</td><td>16S 221 IVE</td></tr> <tr><td>16S 151 MAN</td><td>16S 221 MAN</td></tr> <tr><td>16S 151 RVI</td><td>16S 221 MB</td></tr> <tr><td>16S 151 SNVI</td><td>16S 221 RVI</td></tr> <tr><td>16S 151IT DAF</td><td>16S 221IT IVE</td></tr> <tr><td>16S 181</td><td>16S 221IT MAN</td></tr> <tr><td>16S 181 IVE</td><td>16S 221IT MB</td></tr> <tr><td>16S 181 MAN</td><td>16S 221IT RVI</td></tr> <tr><td></td><td>16S 251 NIS</td></tr> <tr><td></td><td>Ecosplit III</td></tr> </table>	16S 151	16S 181 RVI	16S 151 DAF	16S 181IT DAF	16S 151 HIN	16S 221	16S 151 HYU	16S 221 DAF	16S 151 KMZ	16S 221 IVE	16S 151 MAN	16S 221 MAN	16S 151 RVI	16S 221 MB	16S 151 SNVI	16S 221 RVI	16S 151IT DAF	16S 221IT IVE	16S 181	16S 221IT MAN	16S 181 IVE	16S 221IT MB	16S 181 MAN	16S 221IT RVI		16S 251 NIS		Ecosplit III
16S 151	16S 181 RVI																													
16S 151 DAF	16S 181IT DAF																													
16S 151 HIN	16S 221																													
16S 151 HYU	16S 221 DAF																													
16S 151 KMZ	16S 221 IVE																													
16S 151 MAN	16S 221 MAN																													
16S 151 RVI	16S 221 MB																													
16S 151 SNVI	16S 221 RVI																													
16S 151IT DAF	16S 221IT IVE																													
16S 181	16S 221IT MAN																													
16S 181 IVE	16S 221IT MB																													
16S 181 MAN	16S 221IT RVI																													
	16S 251 NIS																													
	Ecosplit III																													
<p><b>T57436</b></p> 	<p><b>Description:</b> FLANGE</p> <p><b>OEM No :</b> 1328 333 006</p> <p><b>EX / CROSS :</b></p>	<p><b>Packaging Unit:</b> 1</p> <p><b>Model:</b></p> <table border="0"> <tr><td>10AS 2010B IT</td><td>12AS 1935TD</td></tr> <tr><td>10AS 2300BO</td><td>12AS 2000B IT</td></tr> <tr><td>10AS 2310B</td><td>12AS 2000BO</td></tr> <tr><td>10AS 2310B IT</td><td>12AS 2001BO IT</td></tr> <tr><td>10AS 2700BO</td><td>12AS 2130TD</td></tr> <tr><td>12AS 1601BO IT</td><td>12AS 2130TO</td></tr> <tr><td>12AS 1630TD</td><td>12AS 2131TD IT</td></tr> <tr><td>12AS 1631TD IT</td><td>12AS 2131TO IT</td></tr> <tr><td>12AS 1930TD</td><td>12AS 2140TD</td></tr> <tr><td>12AS 1930TO</td><td>12AS 2300B IT</td></tr> <tr><td>12AS 1931TD IT</td><td>12AS 2300BO</td></tr> <tr><td>12AS 1931TO IT</td><td>12AS 2301</td></tr> </table>	10AS 2010B IT	12AS 1935TD	10AS 2300BO	12AS 2000B IT	10AS 2310B	12AS 2000BO	10AS 2310B IT	12AS 2001BO IT	10AS 2700BO	12AS 2130TD	12AS 1601BO IT	12AS 2130TO	12AS 1630TD	12AS 2131TD IT	12AS 1631TD IT	12AS 2131TO IT	12AS 1930TD	12AS 2140TD	12AS 1930TO	12AS 2300B IT	12AS 1931TD IT	12AS 2300BO	12AS 1931TO IT	12AS 2301				
10AS 2010B IT	12AS 1935TD																													
10AS 2300BO	12AS 2000B IT																													
10AS 2310B	12AS 2000BO																													
10AS 2310B IT	12AS 2001BO IT																													
10AS 2700BO	12AS 2130TD																													
12AS 1601BO IT	12AS 2130TO																													
12AS 1630TD	12AS 2131TD IT																													
12AS 1631TD IT	12AS 2131TO IT																													
12AS 1930TD	12AS 2140TD																													
12AS 1930TO	12AS 2300B IT																													
12AS 1931TD IT	12AS 2300BO																													
12AS 1931TO IT	12AS 2301																													
<p><b>T58498</b></p> 	<p><b>Description:</b> FLANGE</p> <p><b>OEM No :</b> 1325 333 016</p> <p><b>EX / CROSS :</b></p>	<p><b>Packaging Unit:</b> 1</p> <p><b>Model:</b></p> <table border="0"> <tr><td>12S 2130TD</td><td>16S 1621TD IT</td></tr> <tr><td>12S 2131TD IT</td><td>16S 1625TD</td></tr> <tr><td>12S 2133TD</td><td>16S 162TD IT</td></tr> <tr><td>12S 2330TD</td><td>16S 1630TD</td></tr> <tr><td>12S 2331TD IT</td><td>16S 1631TD IT</td></tr> <tr><td>12S 2333TD</td><td>16S 1635TD</td></tr> <tr><td>12S 233TD IT</td><td>16S 163TD IT</td></tr> <tr><td>12S 2830TD</td><td>16S 1820TO</td></tr> <tr><td>12S 2831TD IT</td><td>16S 1821TO IT</td></tr> <tr><td>12S 2833TD</td><td>16S 182TO IT</td></tr> <tr><td>12S 283TD IT</td><td>16S 1830TO</td></tr> <tr><td>16S 1620TD</td><td>16S 1831TO IT</td></tr> </table>	12S 2130TD	16S 1621TD IT	12S 2131TD IT	16S 1625TD	12S 2133TD	16S 162TD IT	12S 2330TD	16S 1630TD	12S 2331TD IT	16S 1631TD IT	12S 2333TD	16S 1635TD	12S 233TD IT	16S 163TD IT	12S 2830TD	16S 1820TO	12S 2831TD IT	16S 1821TO IT	12S 2833TD	16S 182TO IT	12S 283TD IT	16S 1830TO	16S 1620TD	16S 1831TO IT				
12S 2130TD	16S 1621TD IT																													
12S 2131TD IT	16S 1625TD																													
12S 2133TD	16S 162TD IT																													
12S 2330TD	16S 1630TD																													
12S 2331TD IT	16S 1631TD IT																													
12S 2333TD	16S 1635TD																													
12S 233TD IT	16S 163TD IT																													
12S 2830TD	16S 1820TO																													
12S 2831TD IT	16S 1821TO IT																													
12S 2833TD	16S 182TO IT																													
12S 283TD IT	16S 1830TO																													
16S 1620TD	16S 1831TO IT																													
<p><b>T20788</b></p> 	<p><b>Description:</b> FLANGE</p> <p><b>OEM No :</b> 5841 300 586</p> <p><b>EX / CROSS :</b></p>	<p><b>Packaging Unit:</b> 1</p> <p><b>Model:</b> VG 1600-300</p>																												





<p><b>T20689</b></p> 	<p><b>Description:</b> FLANGE (58T.)</p> <p><b>OEM No :</b> 1296 333 046</p> <p><b>EX / CROSS :</b> 1296 333 039</p>	<p><b>Packaging Unit:</b> 1</p> <p><b>Model:</b></p> <ul style="list-style-type: none"> <li>16S 151</li> <li>16S 151 DAF</li> <li>16S 151 HIN</li> <li>16S 151 HYU</li> <li>16S 151 IVE</li> <li>16S 151 KMZ</li> <li>16S 151 MAN</li> <li>16S 151 RVI</li> <li>16S 151PTO HIN</li> <li>16S 1620TD</li> <li>16S 1621TD IT</li> <li>16S 1625TD</li> <li>16S 162TD IT</li> <li>16S 1685</li> <li>16S 181</li> <li>16S 181 IVE</li> <li>16S 181 MAN</li> <li>16S 181 RVI</li> <li>16S 181IT DAF</li> <li>16S 182</li> <li>16S 1820TO</li> <li>16S 1820TO KMZ</li> <li>16S 1820TO RVI</li> <li>16S 1821TO IT</li> </ul>
<p><b>T54515</b></p> 	<p><b>Description:</b> FLANGE OUTPUT</p> <p><b>OEM No :</b> 1295 338 061</p> <p><b>EX / CROSS :</b></p>	<p><b>Packaging Unit:</b> 1</p> <p><b>Model:</b></p> <ul style="list-style-type: none"> <li>16K 130</li> <li>16S 112</li> <li>16S 130</li> <li>16S 130/1</li> </ul>
<p><b>T80238</b></p> 	<p><b>Description:</b> FLANGE OUTPUT</p> <p><b>OEM No :</b> 1297 338 010</p> <p><b>EX / CROSS :</b></p>	<p><b>Packaging Unit:</b> 1</p> <p><b>Model:</b></p> <ul style="list-style-type: none"> <li>16K 160</li> <li>16K 190</li> <li>16S 130</li> <li>16S 160</li> <li>16S 160A</li> <li>16S 190</li> <li>16S 190/1</li> <li>16S 190A</li> <li>16S 190A/1</li> <li>16S 220A</li> </ul>
<p><b>T08851</b></p> 	<p><b>Description:</b> FLANGE OUTPUT (31SPL.)</p> <p><b>OEM No :</b> 1285 338 004</p> <p><b>EX / CROSS :</b></p>	<p><b>Packaging Unit:</b> 1</p> <p><b>Model:</b></p>
<p><b>T14812</b></p> 	<p><b>Description:</b> FLANGE OUTPUT (38SPL.)</p> <p><b>OEM No :</b> 1297 338 038</p> <p><b>EX / CROSS :</b></p>	<p><b>Packaging Unit:</b> 1</p> <p><b>Model:</b></p>

<p><b>T08847</b></p> 	<p><b>Description:</b> FLANGE OUTPUT (Ø 150-34SPL.)</p> <p><b>OEM No :</b> 1268 304 136</p> <p><b>EX / CROSS :</b></p>	<p><b>Packaging Unit:</b> 1</p> <p><b>Model:</b></p>
<p><b>T08915</b></p> 	<p><b>Description:</b> FLANGE OUTPUT (Ø 165-34SPL.)</p> <p><b>OEM No :</b> 1269 338 028</p> <p><b>EX / CROSS :</b></p>	<p><b>Packaging Unit:</b> 1</p> <p><b>Model:</b></p>
<p><b>T14810</b></p> 	<p><b>Description:</b> FLANGE OUTPUT (Ø 165-34SPL.)</p> <p><b>OEM No :</b> 1268 304 148</p> <p><b>EX / CROSS :</b></p>	<p><b>Packaging Unit:</b> 1</p> <p><b>Model:</b></p>
<p><b>T08916</b></p> 	<p><b>Description:</b> FLANGE OUTPUT (Ø 180-34SPL.)</p> <p><b>OEM No :</b> 1269 338 020</p> <p><b>EX / CROSS :</b></p>	<p><b>Packaging Unit:</b> 1</p> <p><b>Model:</b></p>
<p><b>T14811</b></p> 	<p><b>Description:</b> FLANGE OUTPUT (Ø 180-36SPL.)</p> <p><b>OEM No :</b> 1295 338 059</p> <p><b>EX / CROSS :</b></p>	<p><b>Packaging Unit:</b> 1</p> <p><b>Model:</b></p>



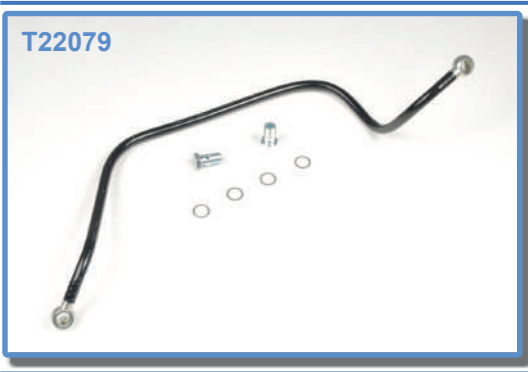

<p><b>T18563</b></p> 	<p><b>Description:</b> FOLLOWER RING</p> <p><b>Packaging Unit:</b> 1</p> <p><b>OEM No :</b> 1315 304 018</p> <p><b>EX / CROSS :</b></p> <p><b>Model:</b> 16S 151 16S 151 DAF 16S 151 HIN 16S 151 HYU 16S 151 IVE 16S 151 KMZ 16S 151 MAN 16S 151 RVI 16S 151 SNVI 16S 151IT DAF 16S 151PTO HIN 16S 1620TD</p> <p>16S 1621TD IT 16S 1625TD 16S 162TD IT 16S 1630TD 16S 1631TD IT 16S 1635TD 16S 163TD IT 16S 1820TO 16S 1820TO KMZ 16S 1820TO RVI 16S 1821TO IT 16S 1822TO</p>
<p><b>T18461</b></p> 	<p><b>Description:</b> FOLLOWER RING</p> <p><b>Packaging Unit:</b> 1</p> <p><b>OEM No :</b> 1312 304 124</p> <p><b>EX / CROSS :</b></p> <p><b>Model:</b> 16S 1685 16S 181 16S 181 IVE 16S 181 MAN 16S 181IT DAF 16S 182 16S 1920TD 16S 1921TD IT 16S 1922TD 16S 1923TD 16S 1925TD 16S 1930TD</p> <p>16S 1931TD IT 16S 1933TD 16S 1935TD 16S 1937TD IT 16S 221 16S 221 DAF 16S 221 IVE 16S 221 MAN 16S 221 MB 16S 221 RVI 16S 221IT IVE 16S 221IT RVI</p>
<p><b>T57360</b></p> 	<p><b>Description:</b> FOLLOWER RING</p> <p><b>Packaging Unit:</b> 1</p> <p><b>OEM No :</b> 1328 302 061</p> <p><b>EX / CROSS :</b> 1329 302 004</p> <p><b>Model:</b> 10AS 2010B IT 10AS 2300BO 10AS 2310B 10AS 2310B IT 10AS 2700BO 12AS 1601BO IT 12AS 1630TD 12AS 1631TD IT 12AS 1930TD 12AS 1930TO 12AS 1931TD IT 12AS 1931TO IT</p> <p>12AS 1935TD 12AS 2000B IT 12AS 2000BO 12AS 2001BO IT 12AS 2130TD 12AS 2130TD IT 12AS 2131TD IT 12AS 2131TO IT 12AS 2140TD 12AS 2300B IT 12AS 2300BO 12AS 2301</p>
<p><b>T57401</b></p> 	<p><b>Description:</b> FOLLOWER RING</p> <p><b>Packaging Unit:</b> 1</p> <p><b>OEM No :</b> 1314 304 119</p> <p><b>EX / CROSS :</b></p> <p><b>Model:</b> 10AS 2010B IT 10AS 2300BO 10AS 2310B 10AS 2310B IT 10AS 2700BO 12AS 1601BO IT 12AS 1630TD 12AS 1631TD IT 12AS 1800 12AS 1800IT 12AS 1930TD 12AS 1930TO</p> <p>12AS 1931TD IT 12AS 1931TO IT 12AS 1935TD 12AS 2000B IT 12AS 2000BO 12AS 2001BO IT 12AS 2130TD 12AS 2130TD IT 12AS 2131TD IT 12AS 2131TO IT 12AS 2140TD 12AS 2300B IT</p>
<p><b>T22696</b></p> 	<p><b>Description:</b> FOLLOWER RING (20T.)</p> <p><b>Packaging Unit:</b> 1</p> <p><b>OEM No :</b> 1290 304 573</p> <p><b>EX / CROSS :</b></p> <p><b>Model:</b> 6S 700BO 6S 700BO KAVZ 6S 850 6S 850 DAF 6S 850 MAN 6S 890</p>

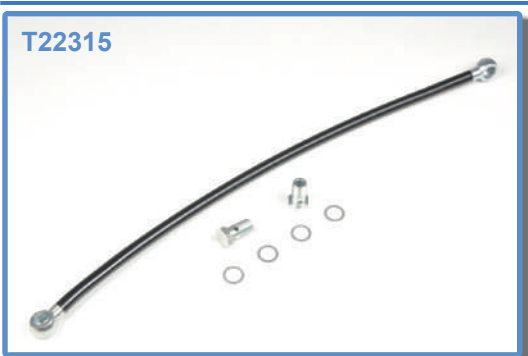

<p><b>T57475</b></p> 	<p><b>Description:</b> FOLLOWER RING (23T.)</p> <p><b>OEM No :</b> 1358 332 223</p> <p><b>EX / CROSS :</b> 1328 332 023 1328 332 033</p>	<p><b>Packaging Unit:</b> 1</p> <p><b>Model:</b> 10AS 2010B IT 10AS 2300BO 10AS 2310B 10AS 2310B IT 10AS 2700BO 12 TX 1410 TD IT (1372 001 023) 12 TX 1410 TD IT (1372 001 030) 12 TX 1410 TO (1372 002 019) 12 TX 1411 TD IT (1372 040 027) 12 TX 1411 TD IT (1372 040 028)</p> <p>12 TX 1415 TD IT (1372 001 026) 12 TX 1610 TO IT (1372 002 025) 12 TX 1610 TO IT (1372 002 045) 12 TX 1611 BO IT (1372 044 006) 12 TX 1611 BO IT (1372 044 033) 12 TX 1611 BO IT (1372 044 050) 12 TX 1611 BO IT (1372 044 051)</p>
<p><b>T19360</b></p> 	<p><b>Description:</b> FOLLOWER RING (24-31T.)</p> <p><b>OEM No :</b> 1295 304 206</p> <p><b>EX / CROSS :</b></p>	<p><b>Packaging Unit:</b> 1</p> <p><b>Model:</b> 16K 130 16S 112 16S 112/1 16S 130 16S 130/1 16S 1300 8S 1350 KMZ</p>
<p><b>T19368</b></p> 	<p><b>Description:</b> FOLLOWER RING (24T.)</p> <p><b>OEM No :</b> 1297 304 154</p> <p><b>EX / CROSS :</b></p>	<p><b>Packaging Unit:</b> 1</p> <p><b>Model:</b> 16K 160 16K 190 16S 160 16S 160/1 16S 1600 16S 160A 16S 160A/1 16S 190 16S 190/1 16S 1900 16S 190A 16S 190A/1</p> <p>16S 200 8S 190</p>
<p><b>T77133</b></p> 	<p><b>Description:</b> FOLLOWER RING (25T.)</p> <p><b>OEM No :</b> 1346 304 177</p> <p><b>EX / CROSS :</b> 1346 304 046 1346 304 119</p>	<p><b>Packaging Unit:</b> 1</p> <p><b>Model:</b> 6AS 1000TO 6AS 1005TO 6AS 1010 BO 6AS 1110BO 6AS 800TO 6AS 805TO 6S 1000TO 6S 1005TO 6S 1010BO 6S 800TO AS Tronic</p>
<p><b>T08572</b></p> 	<p><b>Description:</b> FOLLOWER RING (26T.)</p> <p><b>OEM No :</b> 1250 304 006</p> <p><b>EX / CROSS :</b></p>	<p><b>Packaging Unit:</b> 1</p> <p><b>Model:</b></p>

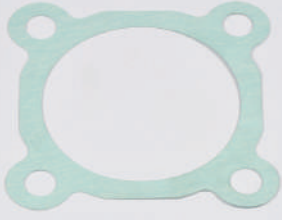

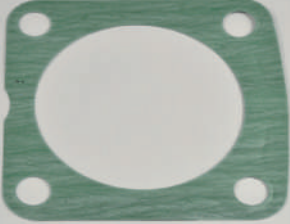

<p><b>T54542</b></p> 	<p><b>Description:</b> FORK</p> <p><b>OEM No :</b> 1328 306 026</p> <p><b>EX / CROSS :</b></p>	<p><b>Packaging Unit:</b> 1</p> <p><b>Model:</b> 10AS 2010B IT 10AS 2300BO 10AS 2310B 10AS 2310B IT 10AS 2700BO 12AS 1601BO IT 12AS 1630TD 12AS 1631TD IT 12AS 1930TD 12AS 1930TO 12AS 1931TD IT 12AS 1931TO IT 12AS 1935TD 12AS 2000B IT 12AS 2000BO 12AS 2001BO IT 12AS 2130TD 12AS 2130TO 12AS 2131TD IT 12AS 2131TO IT 12AS 2300B IT 12AS 2300BO 12AS 2301 12AS 2301BO IT</p>
<p><b>T15875</b></p> 	<p><b>Description:</b> FORK</p> <p><b>OEM No :</b> 1269 307 574</p> <p><b>EX / CROSS :</b> 1250 307 373</p>	<p><b>Packaging Unit:</b> 1</p> <p><b>Model:</b></p>
<p><b>T60361</b></p> 	<p><b>Description:</b> FORK</p> <p><b>OEM No :</b> 1324 306 039</p> <p><b>EX / CROSS :</b> 1324 306 037</p>	<p><b>Packaging Unit:</b> 1</p> <p><b>Model:</b> 9S 1110TD 9S 1110TO 9S 1111TD IT 9S 1111TO IT 9S 1115TD 9S 1115TO 9S 1310TO 9S 1311TO IT 9S 1315TO</p>
<p><b>T15880</b></p> 	<p><b>Description:</b> FORK REVERSE</p> <p><b>OEM No :</b> 1268 306 035</p> <p><b>EX / CROSS :</b></p>	<p><b>Packaging Unit:</b> 1</p> <p><b>Model:</b></p>
<p><b>T22268</b></p> 	<p><b>Description:</b> FUEL PIPE</p> <p><b>OEM No :</b> 1316 245 013</p> <p><b>EX / CROSS :</b> 0501 209 448 0501 211 400</p>	<p><b>Packaging Unit:</b> 1</p> <p><b>Model:</b> 16S 168S 16S 181 IVE 16S 181 MAN 16S 181 RVI 16S 221 IVE 16S 221 MB 16S 221 RVI 16S 221IT IVE 16S 221IT RVI 16S 2280TO</p>



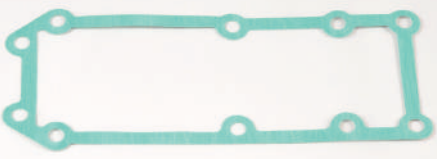
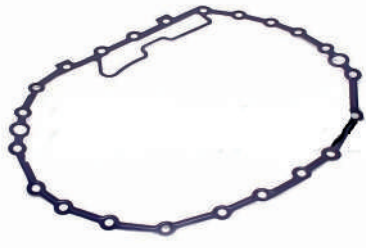

<p><b>T22077</b></p> 	<p><b>Description:</b> FUEL PIPE KIT</p> <p><b>OEM No :</b> 1316 245 013/KIT</p> <p><b>EX / CROSS :</b></p> <p><b>Model:</b> 16S 181 IVE 16S 181 MAN 16S 221 IVE 16S 221 MB 16S 221 RVI 16S 221IT RVI</p>	<p><b>Packaging Unit:</b> 1</p>
<p><b>T22075</b></p> 	<p><b>Description:</b> FUEL PIPE KIT</p> <p><b>OEM No :</b> 1316 245 012/KIT</p> <p><b>EX / CROSS :</b></p> <p><b>Model:</b> 16S 181 IVE 16S 181 MAN 16S 221 IVE 16S 221 MB 16S 221 RVI 16S 221IT RVI</p>	<p><b>Packaging Unit:</b> 1</p>
<p><b>T22079</b></p> 	<p><b>Description:</b> FUEL PIPE KIT</p> <p><b>OEM No :</b> 1315 245 016/KIT</p> <p><b>EX / CROSS :</b></p> <p><b>Model:</b> 16S 151 HIN 16S 151 HYU 16S 151 IVE 16S 151 KMZ 16S 151 MAN 16S 151 RVI 16S 151 SNVI 16S 151PTO HIN</p>	<p><b>Packaging Unit:</b> 1</p>
<p><b>T22091</b></p> 	<p><b>Description:</b> FUEL PIPE KIT</p> <p><b>OEM No :</b> 1315 245 017/KIT</p> <p><b>EX / CROSS :</b></p> <p><b>Model:</b> 16S 151 HIN 16S 151 HYU 16S 151 IVE 16S 151 KMZ 16S 151 MAN 16S 151 RVI 16S 151 SNVI 16S 151PTO HIN</p>	<p><b>Packaging Unit:</b> 1</p>
<p><b>T22315</b></p> 	<p><b>Description:</b> FUEL PIPE KIT</p> <p><b>OEM No :</b> 6007 202 079/KIT</p> <p><b>EX / CROSS :</b></p> <p><b>Model:</b></p>	<p><b>Packaging Unit:</b> 1</p>

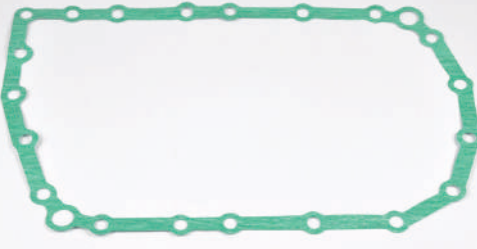



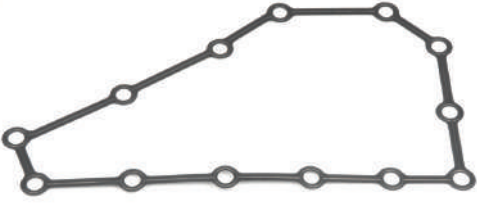

<p><b>T23634</b></p> 	<p><b>Description:</b> GASKET</p> <p><b>OEM No :</b> 6090 301 009</p> <p><b>EX / CROSS :</b></p>	<p><b>Packaging Unit:</b> 1</p> <p><b>Model:</b> 12 TX 1815 TO (1372 002 035) PTO 12AS 3141TO IT 16AS 2230TD 16AS 2600TO 16AS 2630TO 16AS 2631TO IT 16AS 2635TO 16S 151PTO HIN 16S 1635TD 16S 2225TO 16S 2235TD 16S 2725TO</p> <p>6AS 1005TO 6AS 805TO 6S 1205TD 9S 1115TD 9S 1315TO AS Tronic Ecosplit IV - 16 speed</p>
<p><b>T21909</b></p> 	<p><b>Description:</b> GASKET</p> <p><b>OEM No :</b> 1315 307 013</p> <p><b>EX / CROSS :</b></p>	<p><b>Packaging Unit:</b> 10</p> <p><b>Model:</b> 16S 151 16S 151 DAF 16S 151 HIN 16S 151 HYU 16S 151 IVE 16S 151 KMZ 16S 151 MAN 16S 151 RVI 16S 151 SNVI 16S 151IT DAF 16S 151PTO HIN 16S 1625TD</p> <p>16S 162TD IT 16S 1685 16S 181 16S 181 IVE 16S 181 MAN 16S 181 RVI 16S 181IT DAF 16S 182 16S 1820TO KMZ 16S 1820TO RVI 16S 221 16S 221 DAF</p>
<p><b>T21176</b></p> 	<p><b>Description:</b> GASKET</p> <p><b>OEM No :</b> 1238 308 201</p> <p><b>EX / CROSS :</b> 1238 308 032 1238 308 166 1238 309 163</p>	<p><b>Packaging Unit:</b> 10</p> <p><b>Model:</b> 10AS 2300BO 10AS 2310B 10AS 2310B IT 10AS 2700BO 12AS 1210TO 12AS 1220TD 12AS 1420TD 12AS 1420TO 12AS 1620TO 12AS 1630TD 12AS 1631TD IT 12AS 1800</p> <p>12AS 1800IT 12AS 1930TD 12AS 1930TO 12AS 1931TD IT 12AS 1931TO IT 12AS 1935TD 12AS 2000BO 12AS 2130TD 12AS 2130TO 12AS 2131TD IT 12AS 2131TO IT 12AS 2140TD</p>
<p><b>T38530</b></p> 	<p><b>Description:</b> GASKET</p> <p><b>OEM No :</b> 1316 301 053</p> <p><b>EX / CROSS :</b> 1315 301 095 1315 301 094</p>	<p><b>Packaging Unit:</b> 10</p> <p><b>Model:</b> 16S 151 16S 1621TD IT 16S 162TD IT 16S 181 16S 1820TO 16S 1821TO IT 16S 182TO IT 16S 1921TD IT 16S 221 16S 2220TO 16S 2220TO IT 16S 2221TD IT</p> <p>16S 2221TO IT 16S 222TD IT 16S 222TO IT 16S 2321TD IT 16S 232TD IT 16S 251 16S 2521TO IT 16S 2523TO IT 16S 252TO IT 16S 2721TO IT 16S 272TO IT 8S 151</p>
<p><b>T38719</b></p> 	<p><b>Description:</b> GASKET</p> <p><b>OEM No :</b> 1290 301 145</p> <p><b>EX / CROSS :</b> 1290 301 030</p>	<p><b>Packaging Unit:</b> 10</p> <p><b>Model:</b> 6S 850 DAF 6S 850 MAN S6 36</p>



<p><b>T37666</b></p> 	<p><b>Description:</b> GASKET</p> <p><b>OEM No :</b> 0501 316 322</p> <p><b>EX / CROSS :</b></p>	<p><b>Packaging Unit:</b> 5</p> <p><b>Model:</b> 10AS 2010B IT 10AS 2300BO 10AS 2310B 10AS 2310B IT 10AS 2700BO 12AS 1210TO 12AS 1220TD 12AS 1420TO 12AS 1601BO IT 12AS 1620TO 12AS 1630TD 12AS 1631TD IT 12AS 1930TD 12AS 1930TO 12AS 1931TD IT 12AS 1931TO IT 12AS 1935TD 12AS 2000B IT 12AS 2000BO 12AS 2001BO IT 12AS 2130TD 12AS 2130TO 12AS 2131TD IT 12AS 2131TO IT</p>
<p><b>T75057</b></p> 	<p><b>Description:</b> GASKET</p> <p><b>OEM No :</b> 0501 322 825</p> <p><b>EX / CROSS :</b></p>	<p><b>Packaging Unit:</b> 1</p> <p><b>Model:</b> 9S 1110TO 9S 1111TD IT 9S 1111TO IT 9S 1115TO 9S 1310TO 9S 1311TO IT 9S 1315TO</p>
<p><b>T80245</b></p> 	<p><b>Description:</b> GASKET</p> <p><b>OEM No :</b> 0501 321 879</p> <p><b>EX / CROSS :</b></p>	<p><b>Packaging Unit:</b> 1</p> <p><b>Model:</b> 9S 1110TD 9S 1110TO 9S 1111TD IT 9S 1111TO IT 9S 1115TO 9S 1310TO 9S 1311TO IT 9S 1315TO</p>
<p><b>T21040</b></p> 	<p><b>Description:</b> GASKET</p> <p><b>OEM No :</b> 1324 307 082</p> <p><b>EX / CROSS :</b></p>	<p><b>Packaging Unit:</b> 10</p> <p><b>Model:</b> 6S 150C 9S 1110TO 9S 1310TO KMZ</p>
<p><b>T57516</b></p> 	<p><b>Description:</b> GASKET</p> <p><b>OEM No :</b> 0501 324 368</p> <p><b>EX / CROSS :</b> 0501 321 443</p>	<p><b>Packaging Unit:</b> 1</p> <p><b>Model:</b> 10AS 2010B IT 10AS 2300BO 10AS 2310B 10AS 2310B IT 10AS 2700BO 12AS 1601BO IT 12AS 1630TD 12AS 1631TD IT 12AS 1930TD 12AS 1930TO 12AS 1931TD IT 12AS 1931TO IT 12AS 1935TD 12AS 2000B IT 12AS 2000BO 12AS 2001BO IT 12AS 2130TD 12AS 2130TO 12AS 2131TD IT 12AS 2131TO IT 12AS 2140TD 12AS 2300B IT 12AS 2300BO 12AS 2301</p>

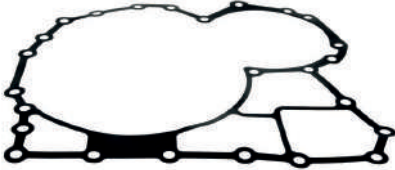

<p><b>T56532</b></p> 	<p><b>Description:</b> GASKET</p> <p><b>Packaging Unit:</b> 1</p> <p><b>OEM No :</b> 0501 331 906</p> <p><b>EX / CROSS :</b></p> <p><b>Model:</b> 12 TX 1410 TD IT (1372 001 023) 12 TX 1410 TD IT (1372 001 030) 12 TX 1410 TO (1372 002 019) 12 TX 1415 TD IT (1372 001 026) 12 TX 1415 TD IT (1372 001 026) S/PUMP 12 TX 1610 TO IT (1372 002 025) 12 TX 1610 TO IT (1372 002 045)</p> <p>12 TX 1810 TO (1372 002 037) 12 TX 1810 TO (1372 002 040) 12 TX 1815 TO (1372 002 035) 12 TX 2420 TD (1358 001 042) 12 TX 2420 TD (1358 001 043) 12 TX 2420 TD (1358 001 046) 12 TX 2420 TD (1358 001 047) 12 TX 2420 TD (1358 001 048) 12 TX 2620 TD IT (1358 001 023) 12 TX 2620 TD IT (1358 001 030) 12 TX 2620 TD IT (1358 001 045)</p>
<p><b>T57315</b></p> 	<p><b>Description:</b> GASKET</p> <p><b>Packaging Unit:</b> 1</p> <p><b>OEM No :</b> 0501 321 451</p> <p><b>EX / CROSS :</b></p> <p><b>Model:</b> 10AS 2010B IT 10AS 2300BO 10AS 2310B 10AS 2310B IT 10AS 2700BO 12AS 1601BO IT 12AS 1630TD 12AS 1631TD IT 12AS 1930TD 12AS 1930TO 12AS 1931TD IT 12AS 1931TO IT</p> <p>12AS 1935TD 12AS 2000B IT 12AS 2000BO 12AS 2001BO IT 12AS 2130TD 12AS 2130TO 12AS 2131TD IT 12AS 2131TO IT 12AS 2140TD 12AS 2300B IT 12AS 2300BO 12AS 2301</p>
<p><b>T57325</b></p> 	<p><b>Description:</b> GASKET</p> <p><b>Packaging Unit:</b> 1</p> <p><b>OEM No :</b> 0501 324 367</p> <p><b>EX / CROSS :</b> 0501 321 442</p> <p><b>Model:</b> 10AS 2010B IT 10AS 2300BO 10AS 2310B 10AS 2310B IT 10AS 2700BO 12AS 1601BO IT 12AS 1630TD 12AS 1631TD IT 12AS 1930TD 12AS 1930TO 12AS 1931TD IT 12AS 1931TO IT</p> <p>12AS 1935TD 12AS 2000B IT 12AS 2000BO 12AS 2001BO IT 12AS 2130TD 12AS 2130TO 12AS 2131TD IT 12AS 2131TO IT 12AS 2140TD 12AS 2300B IT 12AS 2300BO 12AS 2301</p>
<p><b>T38710</b></p> 	<p><b>Description:</b> GASKET</p> <p><b>Packaging Unit:</b> 10</p> <p><b>OEM No :</b> 1290 301 146</p> <p><b>EX / CROSS :</b> 1290 301 035</p> <p><b>Model:</b> 6S 700BO 6S 850 6S 850 DAF 6S 850 MAN 6S 890 S6 36 S6 36+GV36 S6 36/2</p>
<p><b>T21037</b></p> 	<p><b>Description:</b> GASKET</p> <p><b>Packaging Unit:</b> 10</p> <p><b>OEM No :</b> 1304 301 305</p> <p><b>EX / CROSS :</b></p> <p><b>Model:</b> 16S 109 16S 109 STR 6S 150C 8S 109 8S 180 8S 2100BD 8S 2100BO 8S 2101BD IT 8S 2101BO IT 9S 109 9S 109 MAN 9S 109 SNVI</p> <p>9S 1110TD 9S 1110TO 9S 1111TD IT 9S 1111TO IT 9S 1115TD 9S 1115TO 9S 1310TO 9S 1310TO KMZ 9S 1311TO IT 9S 1315TO</p>

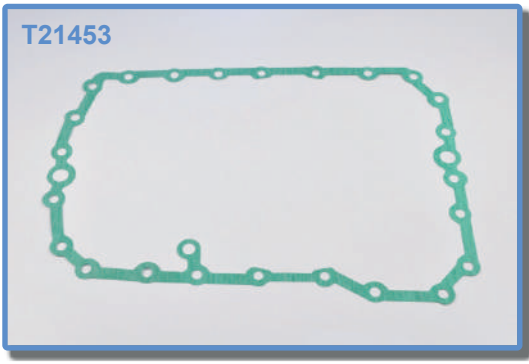
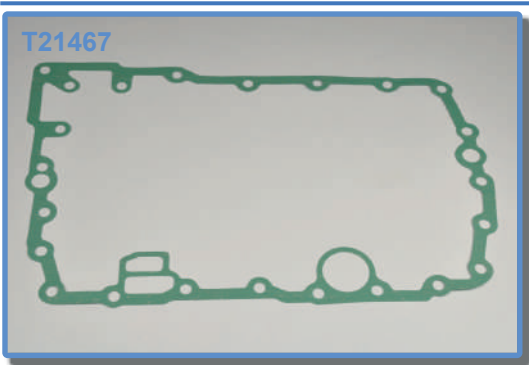
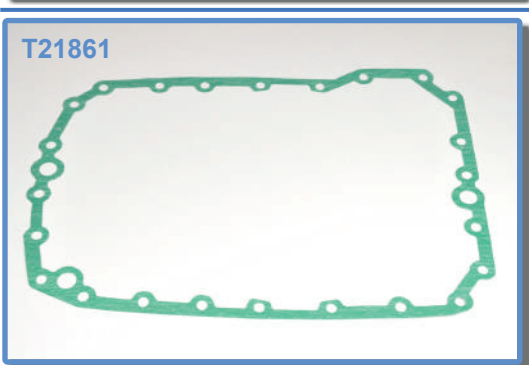
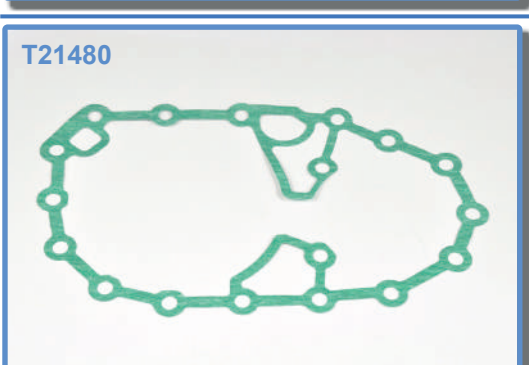
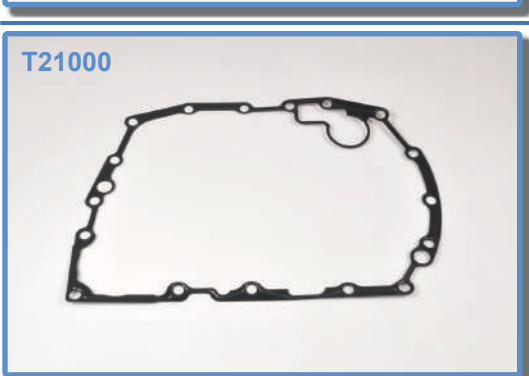
<p><b>T21879</b></p> 	<p><b>Description:</b> GASKET</p> <p><b>OEM No :</b> 1315 301 234</p> <p><b>EX / CROSS :</b> 0501 313 513 1315 301 034</p>	<p><b>Packaging Unit:</b> 10</p> <p><b>Model:</b> 16S 151 16S 151 MAN 16S 151IT DAF 16S 181 16S 181 IVE 16S 181IT DAF 16S 221 16S 221IT IVE 16S 221IT RVI 16S 251 Ecosplit III</p>
<p><b>T21003</b></p> 	<p><b>Description:</b> GASKET</p> <p><b>OEM No :</b> 0501 324 626</p> <p><b>EX / CROSS :</b></p>	<p><b>Packaging Unit:</b> 10</p> <p><b>Model:</b> 6S 150C 9S 1110TO 9S 1310TO KMZ</p>
<p><b>T21916</b></p> 	<p><b>Description:</b> GASKET</p> <p><b>OEM No :</b> 1315 307 242</p> <p><b>EX / CROSS :</b></p>	<p><b>Packaging Unit:</b> 1</p> <p><b>Model:</b> 16S 151 16S 151 HYU 16S 151 IVE 16S 151 MAN 16S 151 RVI 16S 151PTO HIN 16S 1685 16S 181 16S 181 IVE 16S 181 MAN 16S 181 RVI 16S 1820TO RVI 16S 221 16S 221 MAN 16S 221IT RVI 16S 2220TO IVE 16S 2230TO RVI 16S 2280TO 16S 251 16S 251 NIS 16S 2520TO MAN 6S 1600 KMZ 6S 1701BO XAM 6S 1900BO HYU</p>
<p><b>T21441</b></p> 	<p><b>Description:</b> GASKET</p> <p><b>OEM No :</b> 1313 301 036</p> <p><b>EX / CROSS :</b> 1269 301 007 1296 301 007</p>	<p><b>Packaging Unit:</b> 10</p> <p><b>Model:</b> 16K 130 16K 160 16K 190 16S 112 16S 112/1 16S 130 16S 130/1 16S 1300 16S 150 16S 160 16S 160/1 16S 1600 16S 160A 16S 1650 IVE 16S 1650 MAZ 16S 190 16S 190/1 16S 1900 16S 190A 16S 190A/1 16S 200 16S 220 16S 220A 8S 1350 KMZ</p>
<p><b>T38731</b></p> 	<p><b>Description:</b> GASKET</p> <p><b>OEM No :</b> 0501 315 106</p> <p><b>EX / CROSS :</b> 1290 312 167 1290 312 249</p>	<p><b>Packaging Unit:</b> 10</p> <p><b>Model:</b> 6S 700BO 6S 850 6S 850 DAF 6S 890 S6 36 S6 36+GV36 S6 36/2</p>

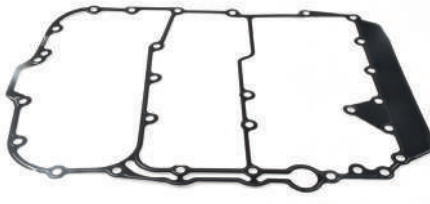
<p><b>T21002</b></p> 	<p><b>Description:</b> GASKET</p> <p><b>OEM No :</b> 0501 322 829</p> <p><b>EX / CROSS :</b></p>	<p><b>Packaging Unit:</b> 1</p> <p><b>Model:</b> 16S 109 6S 150C 8S 109 8S 140 8S 180 8S 2100BD 8S 2100BO 8S 2101BD IT 8S 2101BO IT 9S 109 9S 1110TO 9S 1310TO</p> <p>9S 1310TO KMZ</p>
<p><b>T21041</b></p> 	<p><b>Description:</b> GASKET</p> <p><b>OEM No :</b> 1268 307 170</p> <p><b>EX / CROSS :</b> 1268 307 091</p>	<p><b>Packaging Unit:</b> 5</p> <p><b>Model:</b> 16S 109 16S 109 STR 5S 111GP 5S 111GP+GV90 5S 111GPA 6S 150C 8S 109 8S 140 8S 180 8S 180 ENASA 9S 109 9S 109 MAN</p> <p>9S 109 SNVI 9S 1110TO 9S 1310TO KMZ S6 1550 S6 680 S6 90 SETRA</p>
<p><b>T60654</b></p> 	<p><b>Description:</b> GASKET</p> <p><b>OEM No :</b> 0501 317 289</p> <p><b>EX / CROSS :</b></p>	<p><b>Packaging Unit:</b> 10</p> <p><b>Model:</b> 10AS 2010B IT 10AS 2310B IT 12AS 1601BO IT 12AS 1631TD IT 12AS 1800IT 12AS 1931TD IT 12AS 1931TO IT 12AS 2000B IT 12AS 2001BO IT 12AS 2131TD IT 12AS 2131TO IT 12AS 2300B IT</p> <p>12AS 2301BO IT 12AS 2301IT 12AS 2331TD IT 12AS 2331TO IT 12AS 2341TD IT 12AS 2531TO IT 12AS 2701BO IT 12AS 2741TO IT 12AS 2941TO IT 12AS 3001IT 16AS 2200TD IT 16AS 2231TD IT</p>
<p><b>T21001</b></p> 	<p><b>Description:</b> GASKET</p> <p><b>OEM No :</b> 0501 322 828</p> <p><b>EX / CROSS :</b></p>	<p><b>Packaging Unit:</b> 5</p> <p><b>Model:</b> 16S 109 6S 150C 8S 109 8S 140 8S 180 8S 2100 8S 2100BD 8S 2100BO 8S 2101BD IT 8S 2101BO IT 9S 109 9S 1110TD</p> <p>9S 1110TO 9S 1115TD 9S 1310TO 9S 1310TO KMZ 9S 1315TO</p>
<p><b>T21022</b></p> 	<p><b>Description:</b> GASKET</p> <p><b>OEM No :</b> 1290 301 140</p> <p><b>EX / CROSS :</b> 1290 301 073</p>	<p><b>Packaging Unit:</b> 1</p> <p><b>Model:</b> 16S 109 16S 109 STR 16S 151 16S 221 5S 400V 5S 580 6AS 300VD 6AS 320VD 6AS 380VO 6S 150C 6S 500 TO 6S 850 DAF</p> <p>6S 850 MAN 8S 109 8S 140 8S 180 8S 180 ENASA 8S 2100BD 8S 2100BO 8S 2101BD IT 8S 2101BO IT 9S 109 9S 109 MAN 9S 109 SNVI</p>

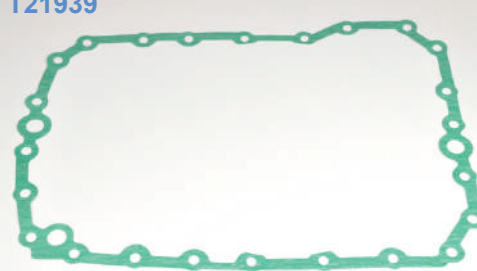
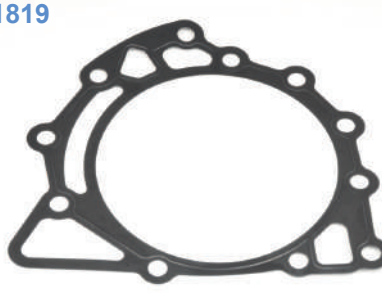
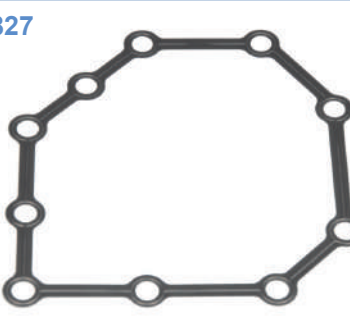
<p><b>T21453</b></p> 	<p><b>Description:</b> GASKET</p> <p><b>OEM No :</b> 1313 301 037</p> <p><b>EX / CROSS :</b> 1296 301 005</p>	<p><b>Packaging Unit:</b> 10</p> <p><b>Model:</b> 16K 130 16K 160 16K 190 16S 112 16S 112/1 16S 130 16S 130/1 16S 1300 16S 150 16S 160 16S 160/1 16S 1600</p> <p>16S 1650 IVE 16S 1650 MAZ 16S 190 16S 190/1 16S 1900 16S 200 16S 220 8S 1350 KMZ 8S 190</p>
<p><b>T21467</b></p> 	<p><b>Description:</b> GASKET</p> <p><b>OEM No :</b> 1313 301 038</p> <p><b>EX / CROSS :</b> 1296 301 004 1296 301 189</p>	<p><b>Packaging Unit:</b> 1</p> <p><b>Model:</b> 16K 130 16K 160 16K 190 16S 112 16S 112/1 16S 130 16S 130/1 16S 1300 16S 150 16S 160 16S 160/1 16S 1600</p> <p>16S 160A 16S 160A/1 16S 1650 IVE 16S 1650 MAZ 16S 190 16S 190/1 16S 1900 16S 190A 16S 190A/1 16S 200 16S 220 16S 220A</p>
<p><b>T21861</b></p> 	<p><b>Description:</b> GASKET</p> <p><b>OEM No :</b> 1315 301 007</p> <p><b>EX / CROSS :</b></p>	<p><b>Packaging Unit:</b> 1</p> <p><b>Model:</b> 16S 151 16S 151 MAN 16S 181 16S 221 16S 251 Ecosplit III</p>
<p><b>T21480</b></p> 	<p><b>Description:</b> GASKET</p> <p><b>OEM No :</b> 1313 302 014</p> <p><b>EX / CROSS :</b> 1297 302 022</p>	<p><b>Packaging Unit:</b> 10</p> <p><b>Model:</b> 16K 130 16K 160 16K 190 16S 112 16S 112/1 16S 130 16S 130/1 16S 1300 16S 150 16S 160 16S 160/1 16S 1600</p> <p>16S 160A 16S 1650 IVE 16S 1650 MAZ 16S 190 16S 190/1 16S 1900 16S 190A 16S 200 16S 220 16S 220A 8S 1350 KMZ 8S 190</p>
<p><b>T21000</b></p> 	<p><b>Description:</b> GASKET</p> <p><b>OEM No :</b> 0501 321 065</p> <p><b>EX / CROSS :</b></p>	<p><b>Packaging Unit:</b> 5</p> <p><b>Model:</b> 16S 109 6S 150C 8S 109 8S 180 8S 2100BD 8S 2100BO 8S 2101BD IT 8S 2101BO IT 9S 109 9S 1110TD 9S 1110TO 9S 1115TD</p> <p>9S 1310TO 9S 1310TO KMZ 9S 1315TO</p>

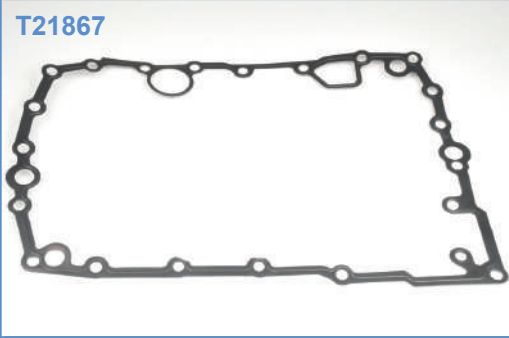
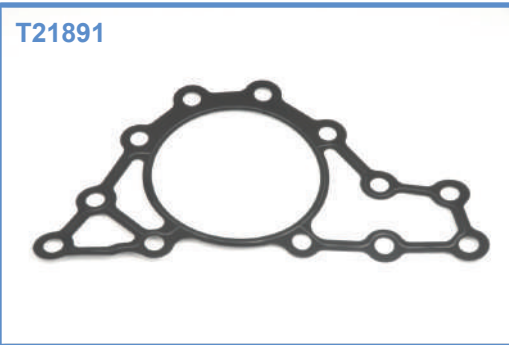
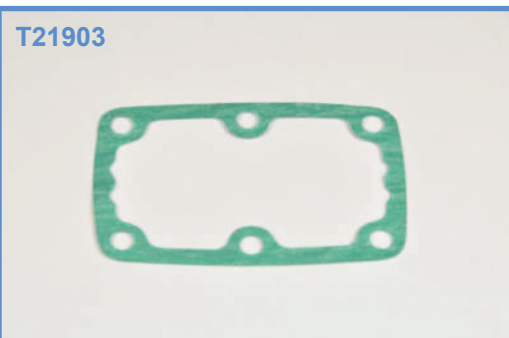
<p><b>T78743</b></p> 	<p><b>Description:</b> GASKET</p> <p><b>OEM No :</b> 0501 327 837</p> <p><b>EX / CROSS :</b></p>	<p><b>Packaging Unit:</b> 1</p> <p><b>Model:</b> 12 TX 1410 TD IT (1372 001 023) 12 TX 1410 TD IT (1372 001 030) 12 TX 1410 TO (1372 002 019) 12 TX 1411 TD IT (1372 040 027) 12 TX 1411 TD IT (1372 040 028) 12 TX 1411 TD IT (1372 040 029) 12 TX 1411 TO IT (1372 041 017)</p> <p>12 TX 1611 BO IT (1372 044 050) 12 TX 1611 BO IT (1372 044 051) 12 TX 1611 BO IT (1372 044 071) 12 TX 1611 BO IT (1372 044 075) 12 TX 1611 TO IT (1372 041 015) 12 TX 1611 TO IT (1372 041 016) 12 TX 1810 TD IT (1372 001 051)</p>
<p><b>T65053</b></p> 	<p><b>Description:</b> GASKET</p> <p><b>OEM No :</b> 0501 331 587</p> <p><b>EX / CROSS :</b>  0501 325 624</p>	<p><b>Packaging Unit:</b> 1</p> <p><b>Model:</b> INTARDER ECO 3/4 GEN - ASTRONIC - AS MID</p>
<p><b>T21939</b></p> 	<p><b>Description:</b> GASKET</p> <p><b>OEM No :</b> 1316 301 042</p> <p><b>EX / CROSS :</b></p>	<p><b>Packaging Unit:</b> 10</p> <p><b>Model:</b> 16S 151 16S 151 DAF 16S 151 HIN 16S 151 HYU 16S 151 IVE 16S 151 KMZ 16S 151 MAN 16S 151 RVI 16S 151 SNVI 16S 151PTO HIN 16S 1620TD 16S 1625TD</p> <p>16S 1685 16S 181 16S 181 MAN 16S 181 RVI 16S 182 16S 1820TO 16S 1820TO KMZ 16S 1820TO RVI 16S 1822TO 16S 1823TO 16S 1825TO 16S 1920TD</p>
<p><b>T21819</b></p> 	<p><b>Description:</b> GASKET</p> <p><b>OEM No :</b> 0501 314 587</p> <p><b>EX / CROSS :</b></p>	<p><b>Packaging Unit:</b> 5</p> <p><b>Model:</b> 16S 151 16S 151 DAF 16S 151 HIN 16S 151 HYU 16S 151 IVE 16S 151 KMZ 16S 151 MAN 16S 151 RVI 16S 151 SNVI 16S 151IT DAF 16S 151PTO HIN 16S 1620TD</p> <p>16S 1621TD IT 16S 1625TD 16S 162TD IT 16S 1685 16S 181 16S 181 IVE 16S 181 MAN 16S 181 RVI 16S 181IT DAF 16S 182 16S 1820TO 16S 1820TO KMZ</p>
<p><b>T21827</b></p> 	<p><b>Description:</b> GASKET</p> <p><b>OEM No :</b> 0501 316 146</p> <p><b>EX / CROSS :</b> 0501 314 808</p>	<p><b>Packaging Unit:</b> 1</p> <p><b>Model:</b> 16S 151 16S 151 DAF 16S 151 HIN 16S 151 HYU 16S 151 IVE 16S 151 KMZ 16S 151 MAN 16S 151 RVI 16S 151 SNVI 16S 151PTO HIN 16S 1685 16S 181</p> <p>16S 181 MAN 16S 181 RVI 16S 1820TO KMZ 16S 1820TO RVI 16S 221 16S 221 DAF 16S 221 IVE 16S 221 MAN 16S 221 MB 16S 221 RVI 16S 251 16S 251 NIS</p>

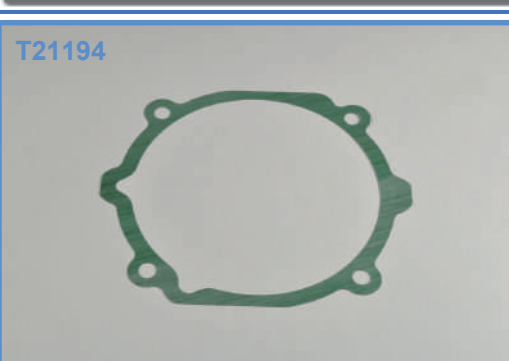



<p><b>T21867</b></p> 	<p><b>Description:</b> GASKET</p> <p><b>OEM No :</b> 1315 301 233</p> <p><b>EX / CROSS :</b> 1315 301 005</p>	<p><b>Packaging Unit:</b> 10</p> <p><b>Model:</b></p> <table border="0"> <tr><td>16S 151</td><td>16S 1621TD IT</td></tr> <tr><td>16S 151 DAF</td><td>16S 1625TD</td></tr> <tr><td>16S 151 HIN</td><td>16S 162TD IT</td></tr> <tr><td>16S 151 HYU</td><td>16S 1685</td></tr> <tr><td>16S 151 IVE</td><td>16S 181</td></tr> <tr><td>16S 151 KMZ</td><td>16S 181 IVE</td></tr> <tr><td>16S 151 MAN</td><td>16S 181 MAN</td></tr> <tr><td>16S 151 RVI</td><td>16S 181 RVI</td></tr> <tr><td>16S 151 SNVI</td><td>16S 181IT DAF</td></tr> <tr><td>16S 151IT DAF</td><td>16S 182</td></tr> <tr><td>16S 151PTO HIN</td><td>16S 1820TO</td></tr> <tr><td>16S 1620TD</td><td>16S 1820TO KMZ</td></tr> </table>	16S 151	16S 1621TD IT	16S 151 DAF	16S 1625TD	16S 151 HIN	16S 162TD IT	16S 151 HYU	16S 1685	16S 151 IVE	16S 181	16S 151 KMZ	16S 181 IVE	16S 151 MAN	16S 181 MAN	16S 151 RVI	16S 181 RVI	16S 151 SNVI	16S 181IT DAF	16S 151IT DAF	16S 182	16S 151PTO HIN	16S 1820TO	16S 1620TD	16S 1820TO KMZ
16S 151	16S 1621TD IT																									
16S 151 DAF	16S 1625TD																									
16S 151 HIN	16S 162TD IT																									
16S 151 HYU	16S 1685																									
16S 151 IVE	16S 181																									
16S 151 KMZ	16S 181 IVE																									
16S 151 MAN	16S 181 MAN																									
16S 151 RVI	16S 181 RVI																									
16S 151 SNVI	16S 181IT DAF																									
16S 151IT DAF	16S 182																									
16S 151PTO HIN	16S 1820TO																									
16S 1620TD	16S 1820TO KMZ																									
<p><b>T21891</b></p> 	<p><b>Description:</b> GASKET</p> <p><b>OEM No :</b> 1315 303 060</p> <p><b>EX / CROSS :</b> 0501 314 747</p>	<p><b>Packaging Unit:</b> 10</p> <p><b>Model:</b></p> <table border="0"> <tr><td>16S 151</td><td>16S 1621TD IT</td></tr> <tr><td>16S 151 DAF</td><td>16S 1625TD</td></tr> <tr><td>16S 151 HIN</td><td>16S 162TD IT</td></tr> <tr><td>16S 151 HYU</td><td>16S 1685</td></tr> <tr><td>16S 151 IVE</td><td>16S 181</td></tr> <tr><td>16S 151 KMZ</td><td>16S 181 IVE</td></tr> <tr><td>16S 151 MAN</td><td>16S 181 MAN</td></tr> <tr><td>16S 151 RVI</td><td>16S 181 RVI</td></tr> <tr><td>16S 151 SNVI</td><td>16S 181IT DAF</td></tr> <tr><td>16S 151IT DAF</td><td>16S 182</td></tr> <tr><td>16S 151PTO HIN</td><td>16S 1820TO</td></tr> <tr><td>16S 1620TD</td><td>16S 1820TO KMZ</td></tr> </table>	16S 151	16S 1621TD IT	16S 151 DAF	16S 1625TD	16S 151 HIN	16S 162TD IT	16S 151 HYU	16S 1685	16S 151 IVE	16S 181	16S 151 KMZ	16S 181 IVE	16S 151 MAN	16S 181 MAN	16S 151 RVI	16S 181 RVI	16S 151 SNVI	16S 181IT DAF	16S 151IT DAF	16S 182	16S 151PTO HIN	16S 1820TO	16S 1620TD	16S 1820TO KMZ
16S 151	16S 1621TD IT																									
16S 151 DAF	16S 1625TD																									
16S 151 HIN	16S 162TD IT																									
16S 151 HYU	16S 1685																									
16S 151 IVE	16S 181																									
16S 151 KMZ	16S 181 IVE																									
16S 151 MAN	16S 181 MAN																									
16S 151 RVI	16S 181 RVI																									
16S 151 SNVI	16S 181IT DAF																									
16S 151IT DAF	16S 182																									
16S 151PTO HIN	16S 1820TO																									
16S 1620TD	16S 1820TO KMZ																									
<p><b>T21903</b></p> 	<p><b>Description:</b> GASKET</p> <p><b>OEM No :</b> 1315 307 012</p> <p><b>EX / CROSS :</b></p>	<p><b>Packaging Unit:</b> 10</p> <p><b>Model:</b></p> <table border="0"> <tr><td>16S 151</td><td>16S 221IT IVE</td></tr> <tr><td>16S 151 DAF</td><td>16S 251</td></tr> <tr><td>16S 151 MAN</td><td>8S 151 DAF</td></tr> <tr><td>16S 151 SNVI</td><td>Ecosplit III</td></tr> <tr><td>16S 151IT DAF</td><td></td></tr> <tr><td>16S 181</td><td></td></tr> <tr><td>16S 181IT DAF</td><td></td></tr> <tr><td>16S 221</td><td></td></tr> <tr><td>16S 221 DAF</td><td></td></tr> <tr><td>16S 221 IVE</td><td></td></tr> <tr><td>16S 221 MB</td><td></td></tr> <tr><td>16S 221 RVI</td><td></td></tr> </table>	16S 151	16S 221IT IVE	16S 151 DAF	16S 251	16S 151 MAN	8S 151 DAF	16S 151 SNVI	Ecosplit III	16S 151IT DAF		16S 181		16S 181IT DAF		16S 221		16S 221 DAF		16S 221 IVE		16S 221 MB		16S 221 RVI	
16S 151	16S 221IT IVE																									
16S 151 DAF	16S 251																									
16S 151 MAN	8S 151 DAF																									
16S 151 SNVI	Ecosplit III																									
16S 151IT DAF																										
16S 181																										
16S 181IT DAF																										
16S 221																										
16S 221 DAF																										
16S 221 IVE																										
16S 221 MB																										
16S 221 RVI																										
<p><b>T21922</b></p> 	<p><b>Description:</b> GASKET</p> <p><b>OEM No :</b> 1315 331 001</p> <p><b>EX / CROSS :</b> 0750 112 136</p>	<p><b>Packaging Unit:</b> 1</p> <p><b>Model:</b></p> <table border="0"> <tr><td>16S 151</td><td>16S 1685</td></tr> <tr><td>16S 151 DAF</td><td>16S 181</td></tr> <tr><td>16S 151 HIN</td><td>16S 181 MAN</td></tr> <tr><td>16S 151 HYU</td><td>16S 181 RVI</td></tr> <tr><td>16S 151 IVE</td><td>16S 182</td></tr> <tr><td>16S 151 KMZ</td><td>16S 1820TO</td></tr> <tr><td>16S 151 MAN</td><td>16S 1820TO KMZ</td></tr> <tr><td>16S 151 RVI</td><td>16S 1820TO RVI</td></tr> <tr><td>16S 151 SNVI</td><td>16S 1822TO</td></tr> <tr><td>16S 151PTO HIN</td><td>16S 1823TO</td></tr> <tr><td>16S 1620TD</td><td>16S 1825TO</td></tr> <tr><td>16S 1625TD</td><td>16S 1920TD</td></tr> </table>	16S 151	16S 1685	16S 151 DAF	16S 181	16S 151 HIN	16S 181 MAN	16S 151 HYU	16S 181 RVI	16S 151 IVE	16S 182	16S 151 KMZ	16S 1820TO	16S 151 MAN	16S 1820TO KMZ	16S 151 RVI	16S 1820TO RVI	16S 151 SNVI	16S 1822TO	16S 151PTO HIN	16S 1823TO	16S 1620TD	16S 1825TO	16S 1625TD	16S 1920TD
16S 151	16S 1685																									
16S 151 DAF	16S 181																									
16S 151 HIN	16S 181 MAN																									
16S 151 HYU	16S 181 RVI																									
16S 151 IVE	16S 182																									
16S 151 KMZ	16S 1820TO																									
16S 151 MAN	16S 1820TO KMZ																									
16S 151 RVI	16S 1820TO RVI																									
16S 151 SNVI	16S 1822TO																									
16S 151PTO HIN	16S 1823TO																									
16S 1620TD	16S 1825TO																									
16S 1625TD	16S 1920TD																									
<p><b>T21194</b></p> 	<p><b>Description:</b> GASKET</p> <p><b>OEM No :</b> 1250 302 298</p> <p><b>EX / CROSS :</b> 1250 302 373 1250 302 478</p>	<p><b>Packaging Unit:</b> 1</p> <p><b>Model:</b></p> <table border="0"> <tr><td>AK6 65</td><td>S6 90</td></tr> <tr><td>AK6 65+GV80</td><td>S6 90 SETRA</td></tr> <tr><td>AK6 80</td><td>S6 90+GV90</td></tr> <tr><td>AK6 80+GV80</td><td>S6 90+GV90 SNVI</td></tr> <tr><td>AK6 90</td><td>S6 90/1</td></tr> <tr><td>AK6 90+GV90</td><td>S6 90/1+GV90</td></tr> <tr><td>S6 1550</td><td></td></tr> <tr><td>S6 65</td><td></td></tr> <tr><td>S6 65+GV80</td><td></td></tr> <tr><td>S6 80+GV80</td><td></td></tr> <tr><td>S6 80/1</td><td></td></tr> <tr><td>S6 80/1+GV80</td><td></td></tr> </table>	AK6 65	S6 90	AK6 65+GV80	S6 90 SETRA	AK6 80	S6 90+GV90	AK6 80+GV80	S6 90+GV90 SNVI	AK6 90	S6 90/1	AK6 90+GV90	S6 90/1+GV90	S6 1550		S6 65		S6 65+GV80		S6 80+GV80		S6 80/1		S6 80/1+GV80	
AK6 65	S6 90																									
AK6 65+GV80	S6 90 SETRA																									
AK6 80	S6 90+GV90																									
AK6 80+GV80	S6 90+GV90 SNVI																									
AK6 90	S6 90/1																									
AK6 90+GV90	S6 90/1+GV90																									
S6 1550																										
S6 65																										
S6 65+GV80																										
S6 80+GV80																										
S6 80/1																										
S6 80/1+GV80																										

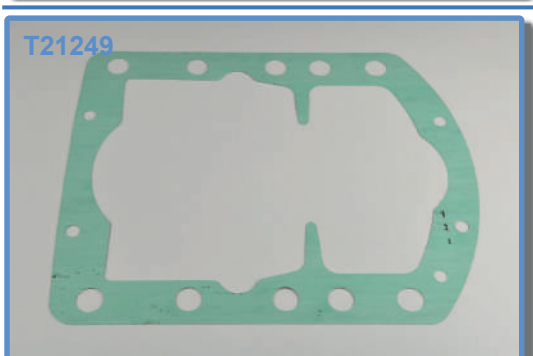



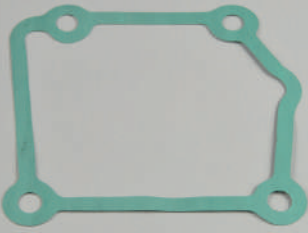

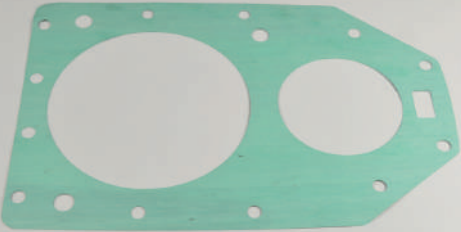

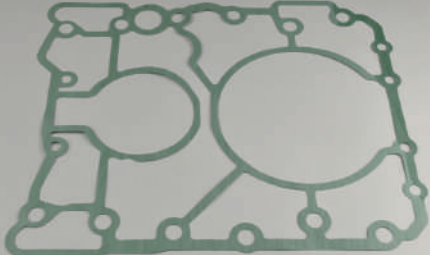
<p><b>T21217</b></p> 	<p><b>Description:</b> GASKET</p> <p><b>OEM No :</b> 1250 306 282</p> <p><b>EX / CROSS :</b> 1250 306 182</p>	<p><b>Packaging Unit:</b> 1</p> <p><b>Model:</b> AK6 80 AK6 80+GV80 AK6 90 AK6 90+GV90 S6 1550 S6 80 S6 80+GV80 S6 80/1 S6 80/1+GV80 S6 90 S6 90 SETRA S6 90+GV90</p> <p>S6 90+GV90 SNVI S6 90/1 S6 90/1+GV90</p>
<p><b>T21235</b></p> 	<p><b>Description:</b> GASKET</p> <p><b>OEM No :</b> 1250 307 680</p> <p><b>EX / CROSS :</b></p>	<p><b>Packaging Unit:</b> 1</p> <p><b>Model:</b> AK6 65 AK6 65+GV80</p>
<p><b>T21239</b></p> 	<p><b>Description:</b> GASKET</p> <p><b>OEM No :</b> 1250 307 686</p> <p><b>EX / CROSS :</b> 1250 307 521</p>	<p><b>Packaging Unit:</b> 1</p> <p><b>Model:</b> 5S 111GP 5S 111GP+GV90 5S 111GPA 5S 90GP 5S 90GPA 5S 92GP AK6 65 AK6 65+GV80 AK6 80 AK6 80+GV80 AK6 90 AK6 90+GV90</p> <p>S6 65 S6 65+GV80 S6 90 S6 90+GV90</p>
<p><b>T21249</b></p> 	<p><b>Description:</b> GASKET</p> <p><b>OEM No :</b> 1250 312 473</p> <p><b>EX / CROSS :</b> 1250 312 222</p>	<p><b>Packaging Unit:</b> 1</p> <p><b>Model:</b> AK6 65 AK6 65+GV80 AK6 80+GV80 AK6 90 AK6 90+GV90 S6 65 S6 65+GV80 S6 80+GV80 S6 80/1+GV80 S6 90 S6 90+GV90 S6 90+GV90 SNVI</p> <p>S6 90/1+GV90</p>
<p><b>T21261</b></p> 	<p><b>Description:</b> GASKET</p> <p><b>OEM No :</b> 1252 307 068</p> <p><b>EX / CROSS :</b> 1252 307 060</p>	<p><b>Packaging Unit:</b> 10</p> <p><b>Model:</b> 4S 150GP 4S 150GP+400 5K 110GP 5K 110GP+GV90 5K 110GPA 5K 110GPA+GV90 5K 90GP 5K 90GPA 5K 91GP 5K 91GPA 5S 110GP 5S 110GP+GV90</p> <p>5S 110GPA 5S 110GPA+GV90 5S 111GP 5S 111GP+GV90 5S 111GPA 5S 90GP 5S 90GPA 5S 92GP AK6 65 AK6 65+GV80 AK6 80 AK6 80+GV80</p>

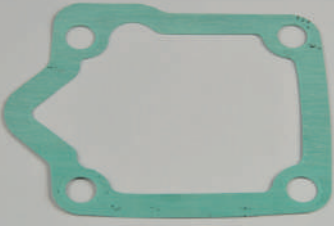

<p><b>T21282</b></p> 	<p><b>Description:</b> GASKET</p> <p><b>OEM No :</b> 1268 303 132</p> <p><b>EX / CROSS :</b> 1268 303 071</p> <p><b>Model:</b> S6 1550 S6 90 S6 90 SETRA S6 90+GV90 S6 90+GV90 SNVI S6 90/1 S6 90/1+GV90</p>	<p><b>Packaging Unit:</b> 1</p>
<p><b>T21297</b></p> 	<p><b>Description:</b> GASKET</p> <p><b>OEM No :</b> 1268 307 169</p> <p><b>EX / CROSS :</b> 1203 307 289</p> <p><b>Model:</b> 5S 111GP 5S 111GP+GV90 5S 111GPA AK5 35/2 AK6 65 AK6 65+GV80 S5 35/2 S6 1550 S6 65+GV80 S6 90+GV90 SNVI</p>	<p><b>Packaging Unit:</b> 1</p>
<p><b>T21310</b></p> 	<p><b>Description:</b> GASKET</p> <p><b>OEM No :</b> 1268 308 020</p> <p><b>EX / CROSS :</b> 1268 308 003</p> <p><b>Model:</b> S6 90 S6 90 SETRA S6 90+GV90 S6 90+GV90 SNVI S6 90/1 S6 90/1+GV90</p>	<p><b>Packaging Unit:</b> 1</p>
<p><b>T21326</b></p> 	<p><b>Description:</b> GASKET</p> <p><b>OEM No :</b> 1269 331 078</p> <p><b>EX / CROSS :</b> 1269 331 036</p> <p><b>Model:</b> 4S 150GP 4S 150GP+400 5K 110GP 5K 110GP+GV90 5K 110GPA 5K 110GPA+GV90 5S 110GP 5S 110GP+GV90 5S 110GPA 5S 110GPA+GV90 5S 111GP 5S 111GP+GV90</p>	<p><b>Packaging Unit:</b> 1</p> <p>5S 111GPA</p>
<p><b>T21338</b></p> 	<p><b>Description:</b> GASKET</p> <p><b>OEM No :</b> 1269 331 077</p> <p><b>EX / CROSS :</b> 1269 331 035</p> <p><b>Model:</b> 4S 150GP 4S 150GP+400 5K 110GP 5K 110GP+GV90 5K 110GPA 5K 110GPA+GV90 5S 110GP 5S 110GP+GV90 5S 110GPA 5S 110GPA+GV90 5S 111GP 5S 111GP+GV90</p>	<p><b>Packaging Unit:</b> 1</p> <p>5S 111GPA</p>

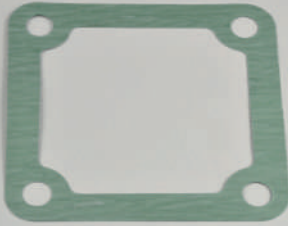



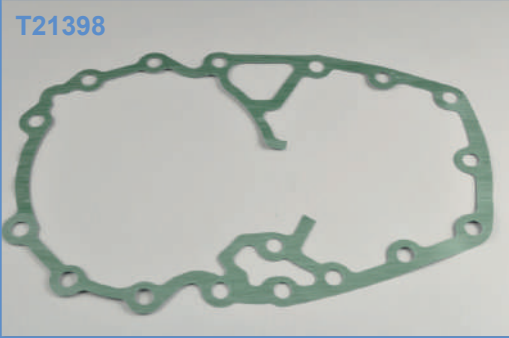
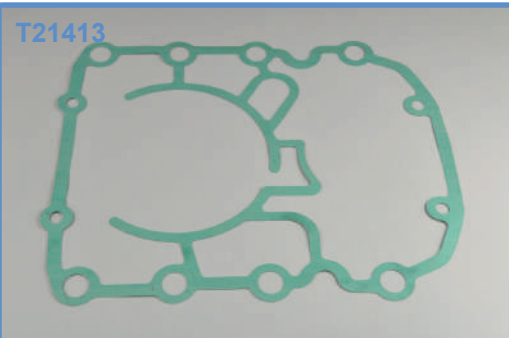
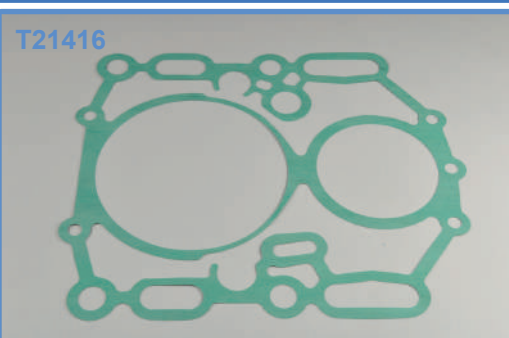
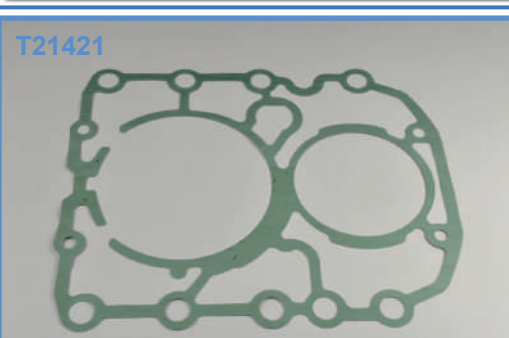
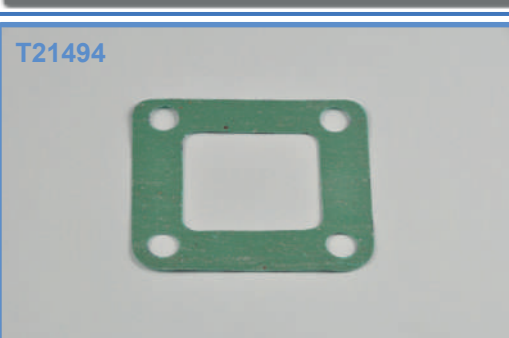

<p><b>T21350</b></p> 	<p><b>Description:</b> GASKET</p> <p><b>OEM No :</b> 1269 307 645</p> <p><b>EX / CROSS :</b> 1269 307 514</p>	<p><b>Packaging Unit:</b> 1</p> <p><b>Model:</b> 5S 111GP 5S 111GP+GV90 5S 111GPA 5S 90GP 5S 90GPA 5S 92GP</p>
<p><b>T21357</b></p> 	<p><b>Description:</b> GASKET</p> <p><b>OEM No :</b> 1269 307 650</p> <p><b>EX / CROSS :</b></p>	<p><b>Packaging Unit:</b> 1</p> <p><b>Model:</b> AK6 65 AK6 65+GV80 S6 65 S6 65+GV80</p>
<p><b>T21361</b></p> 	<p><b>Description:</b> GASKET</p> <p><b>OEM No :</b> 1269 307 644</p> <p><b>EX / CROSS :</b> 1269 307 299</p>	<p><b>Packaging Unit:</b> 1</p> <p><b>Model:</b> 5S 111GP 5S 111GP+GV90 5S 111GPA</p>
<p><b>T21374</b></p> 	<p><b>Description:</b> GASKET</p> <p><b>OEM No :</b> 1269 307 643</p> <p><b>EX / CROSS :</b> 1269 307 200</p>	<p><b>Packaging Unit:</b> 1</p> <p><b>Model:</b> 5S 111GP 5S 111GP+GV90 5S 111GPA 5S 90GP 5S 90GPA 5S 92GP</p>
<p><b>T21386</b></p> 	<p><b>Description:</b> GASKET</p> <p><b>OEM No :</b> 1269 307 642</p> <p><b>EX / CROSS :</b> 1269 307 026</p>	<p><b>Packaging Unit:</b> 1</p> <p><b>Model:</b> 4S 150GP 4S 150GP+400 5K 110GP 5K 110GP+GV90 5K 110GPA 5K 110GPA+GV90 5S 110GP 5S 110GP+GV90 5S 110GPA 5S 110GPA+GV90 5S 111GP 5S 111GP+GV90</p> <p>5S 111GPA</p>

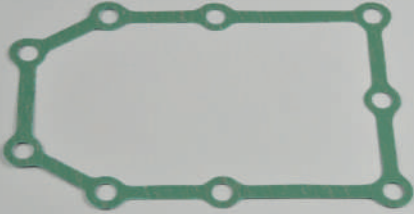

<p><b>T21398</b></p> 	<p><b>Description:</b> GASKET</p> <p><b>OEM No :</b> 1269 302 305</p> <p><b>EX / CROSS :</b> 1269 302 161</p>	<p><b>Packaging Unit:</b> 1</p> <p><b>Model:</b> 4S 150GP 5K 110GP 5K 110GP+GV90 5K 90GP 5K 91GP 5S 110GP 5S 110GP+GV90 5S 111GP 5S 111GP+GV90 5S 111GPA 5S 90GP 5S 92GP</p> <p>S4 90</p>
<p><b>T21413</b></p> 	<p><b>Description:</b> GASKET</p> <p><b>OEM No :</b> 1269 302 303</p> <p><b>EX / CROSS :</b> 1269 302 163</p>	<p><b>Packaging Unit:</b> 1</p> <p><b>Model:</b> 5K 110GPA 5K 110GPA+GV90 5S 111GP 5S 111GP+GV90 5S 111GPA</p>
<p><b>T21416</b></p> 	<p><b>Description:</b> GASKET</p> <p><b>OEM No :</b> 1250 319 040</p> <p><b>EX / CROSS :</b> 1250 319 035</p>	<p><b>Packaging Unit:</b> 1</p> <p><b>Model:</b> 5K 110GP+GV90 5K 110GPA+GV90 5S 110GP+GV90 5S 110GPA+GV90 5S 111GP+GV90</p>
<p><b>T21421</b></p> 	<p><b>Description:</b> GASKET</p> <p><b>OEM No :</b> 1250 302 485</p> <p><b>EX / CROSS :</b> 1250 302 301</p>	<p><b>Packaging Unit:</b> 1</p> <p><b>Model:</b> 4S 120GP 5S 110GPA 5S 111GP 5S 111GP+GV90 5S 111GPA 5S 90GPA AK6 65 AK6 80 AK6 90 S6 65 S6 65+GV80 S6 80</p> <p>S6 90</p>
<p><b>T21494</b></p> 	<p><b>Description:</b> GASKET</p> <p><b>OEM No :</b> 1313 306 012</p> <p><b>EX / CROSS :</b> 1295 306 041</p>	<p><b>Packaging Unit:</b> 1</p> <p><b>Model:</b> 16S 112 16S 112/1 16S 130 16S 130/1 16S 150 16S 160 16S 160/1 16S 1650 IVE 16S 1650 MAZ 16S 190 16S 190/1 16S 220</p> <p>8S 1350 KMZ</p>



<p><b>T21508</b></p> 	<p><b>Description:</b> GASKET</p> <p><b>OEM No :</b> 1313 307 002</p> <p><b>EX / CROSS :</b> 1295 307 162</p>	<p><b>Packaging Unit:</b> 1</p> <p><b>Model:</b> 16S 112 16S 112/1 16S 130 16S 130/1 16S 150 16S 160 16S 160/1 16S 1650 IVE 16S 1650 MAZ 16S 190 16S 190/1 16S 220</p> <p>8S 1350 KMZ</p>
<p><b>T21520</b></p> 	<p><b>Description:</b> GASKET</p> <p><b>OEM No :</b> 1313 307 003</p> <p><b>EX / CROSS :</b> 1295 307 076</p>	<p><b>Packaging Unit:</b> 1</p> <p><b>Model:</b> 16K 130 16K 160 16K 190 16S 112 16S 112/1 16S 130 16S 130/1 16S 150 16S 160 16S 160/1 16S 160A 16S 160A/1</p> <p>16S 1650 IVE 16S 1650 MAZ 16S 190 16S 190/1 16S 190A 16S 190A/1 16S 220 16S 220A 8S 1350 KMZ 8S 190</p>
<p><b>T21534</b></p> 	<p><b>Description:</b> GASKET</p> <p><b>OEM No :</b> 1313 307 004</p> <p><b>EX / CROSS :</b> 1295 307 053</p>	<p><b>Packaging Unit:</b> 1</p> <p><b>Model:</b> 16K 130 16K 160 16K 190 16S 112 16S 112/1 16S 130 16S 130/1 16S 150 16S 160 16S 160/1 16S 160A 16S 160A/1</p> <p>16S 1650 IVE 16S 1650 MAZ 16S 190 16S 190/1 16S 190A 16S 190A/1 16S 220 16S 220A 8S 1350 KMZ 8S 190</p>
<p><b>T21547</b></p> 	<p><b>Description:</b> GASKET</p> <p><b>OEM No :</b> 1313 307 005</p> <p><b>EX / CROSS :</b> 1295 307 392</p>	<p><b>Packaging Unit:</b> 1</p> <p><b>Model:</b> 16S 112 16S 112/1 16S 130 16S 130/1 16S 150 16S 160 16S 160/1 16S 190 16S 190/1 16S 220</p>
<p><b>T21558</b></p> 	<p><b>Description:</b> GASKET</p> <p><b>OEM No :</b> 1313 307 006</p> <p><b>EX / CROSS :</b> 1295 307 423</p>	<p><b>Packaging Unit:</b> 1</p> <p><b>Model:</b> 16S 112 16S 112/1 16S 130 16S 130/1 16S 150 16S 160 16S 160/1 16S 190 16S 190/1 16S 220</p>

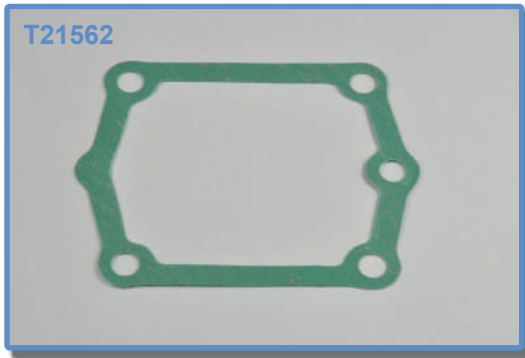

**T21562**

**Description:**  
GASKET

**Packaging Unit:** 1

**OEM No :**  
1313 307 022

**Model:**  
16S 112  
16S 112/1  
16S 130  
16S 130/1  
16S 150  
16S 160  
16S 160/1  
16S 190  
16S 190/1  
16S 220

**EX / CROSS :**  
1296 307 046

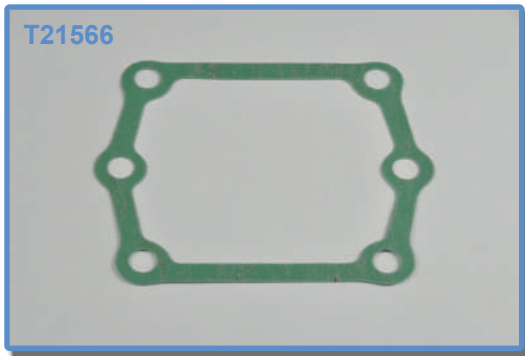

**T21566**

**Description:**  
GASKET

**Packaging Unit:** 1

**OEM No :**  
1313 307 020

**Model:**  
16K 130  
16K 160  
16K 190  
16S 112  
16S 112/1  
16S 130  
16S 130/1  
16S 150  
16S 160  
16S 160/1  
16S 160A  
16S 160A/1

**EX / CROSS :**  
1295 307 054  
1313 307 001

16S 1650 IVE  
16S 1650 MAZ  
16S 190  
16S 190/1  
16S 190A  
16S 190A/1  
16S 220  
16S 220A  
8S 1350 KMZ  
8S 190



**T21583**

**Description:**  
GASKET

**Packaging Unit:** 1

**OEM No :**  
0501 310 614

**Model:**  
16S 112  
16S 112/1  
16S 130  
16S 130/1  
16S 150  
16S 160  
16S 160/1  
16S 190  
16S 190/1  
16S 220

**EX / CROSS :**

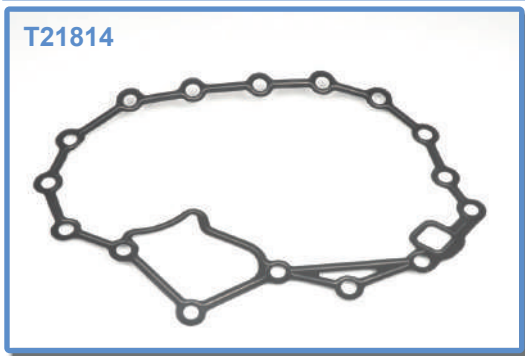

**T21814**

**Description:**  
GASKET

**Packaging Unit:** 1

**OEM No :**  
0501 314 246

**Model:**  
16S 151  
16S 151 MAN  
16S 181  
16S 221  
16S 251  
Ecosplit III

**EX / CROSS :**  
0750 112 138  
0750 112 153

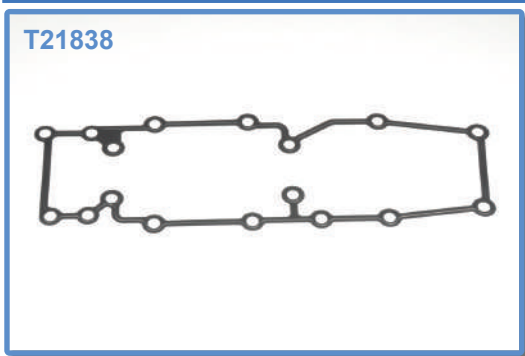

**T21838**





**Description:**  
GASKET

**Packaging Unit:** 1

**OEM No :**  
0501 324 072

**Model:**  
16S 151 HYU  
16S 151 MAN  
16S 151 RVI  
16S 151PTO HIN  
16S 181 IVE  
16S 181 MAN  
16S 181 RVI  
16S 221 MAN  
16S 221IT RVI  
16S 251 NIS

**EX / CROSS :**  
0501 317 240  
1315 307 267

<p><b>T21843</b></p> 	<p><b>Description:</b> GASKET</p> <p><b>Packaging Unit:</b> 1</p> <p><b>OEM No :</b> 1304 307 177</p> <p><b>EX / CROSS :</b> 1304 307 013 0501 318 308</p> <p><b>Model:</b> 16S 109 16S 109 STR 16S 151 16S 151 DAF 16S 151 HIN 16S 151 HYU 16S 151 KMZ 16S 151 MAN 16S 151 RVI 16S 151 SNVI 16S 151IT DAF 16S 151PTO HIN</p> <p>16S 181 16S 181 IVE 16S 181 MAN 16S 181 RVI 16S 181IT DAF 16S 1820TO KMZ 16S 221 16S 221 DAF 16S 221 IVE 16S 221 MAN 16S 221 MB 16S 221 RVI</p>
<p><b>T21934</b></p> 	<p><b>Description:</b> GASKET</p> <p><b>Packaging Unit:</b> 1</p> <p><b>OEM No :</b> 1316 301 022</p> <p><b>EX / CROSS :</b></p> <p><b>Model:</b> 16S 151 16S 151 MAN 16S 181 16S 221 16S 251 Ecosplit III</p>
<p><b>T78748</b></p> 	<p><b>Description:</b> GASKET</p> <p><b>Packaging Unit:</b> 1</p> <p><b>OEM No :</b> 0501 331 264</p> <p><b>EX / CROSS :</b></p> <p><b>Model:</b> 12 TX 1410 TD IT (1372 001 023) 12 TX 1410 TD IT (1372 001 030) 12 TX 1410 TO (1372 002 019) 12 TX 1411 TD IT (1372 040 027) 12 TX 1411 TD IT (1372 040 028) 12 TX 1411 TD IT (1372 040 029) 12 TX 1411 TO IT (1372 041 017) 12 TX 1611 BO IT (1372 044 050) 12 TX 1611 BO IT (1372 044 051) 12 TX 1611 BO IT (1372 044 071) 12 TX 1611 BO IT (1372 044 075) 12 TX 1611 TO IT (1372 041 015) 12 TX 1611 TO IT (1372 041 016) 12 TX 1810 TD IT (1372 001 024)</p>
<p><b>T78994</b></p> 	<p><b>Description:</b> GASKET</p> <p><b>Packaging Unit:</b> 1</p> <p><b>OEM No :</b> 0501 329 501</p> <p><b>EX / CROSS :</b></p> <p><b>Model:</b> 12 TX 1410 TD IT (1372 001 023) 12 TX 1410 TD IT (1372 001 030) 12 TX 1410 TO (1372 002 019) 12 TX 1411 TD IT (1372 040 027) 12 TX 1411 TD IT (1372 040 028) 12 TX 1411 TD IT (1372 040 029) 12 TX 1411 TO IT (1372 041 017) 12 TX 1611 BO IT (1372 044 050) 12 TX 1611 BO IT (1372 044 051) 12 TX 1611 BO IT (1372 044 071) 12 TX 1611 BO IT (1372 044 075) 12 TX 1611 TO IT (1372 041 015) 12 TX 1611 TO IT (1372 041 016) 12 TX 1810 TD IT (1372 001 024)</p>
<p><b>T94569</b></p> 	<p><b>Description:</b> GASKET AND OIL SEAL BIG KIT FOR VALVE ZF 0501 215 441</p> <p><b>Packaging Unit:</b> 1</p> <p><b>OEM No :</b> TAS94569</p> <p><b>EX / CROSS :</b></p> <p><b>Model:</b> 16S 2220TD 16S 2520TO</p>



**T94575**

**Description:**

GASKET AND OIL SEAL BIG KIT FOR VALVE ZF 0501 217 295

**Packaging Unit:** 1

**OEM No :**

TAS94575

**Model:**

16S 1650  
16S 2325TD  
16S 2520TO  
16S 2525TO

**EX / CROSS :**



**T20200**

**Description:**

GASKET AND OIL SEAL KIT

**Packaging Unit:** 1

**OEM No :**

1295 298 960

**Model:**

**EX / CROSS :**

1295 298 917

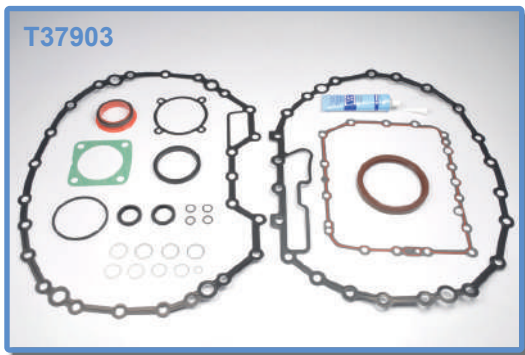

**T37903**

**Description:**

GASKET AND OIL SEAL KIT

**Packaging Unit:** 1

**OEM No :**

1327 298 001

**Model:**

12AS 1930TO  
12AS 2330TO  
AS Tronic

**EX / CROSS :**

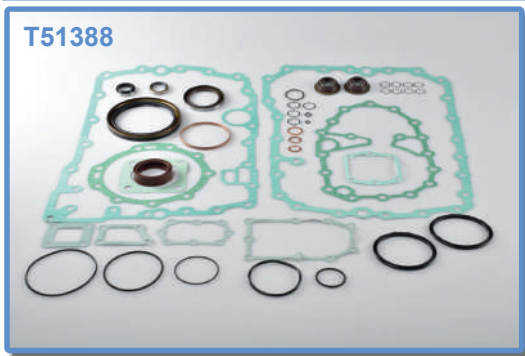

**T51388**

**Description:**

GASKET AND OIL SEAL KIT

**Packaging Unit:** 1

**OEM No :**

1297 298 801

**Model:**

16S 1600

**EX / CROSS :**

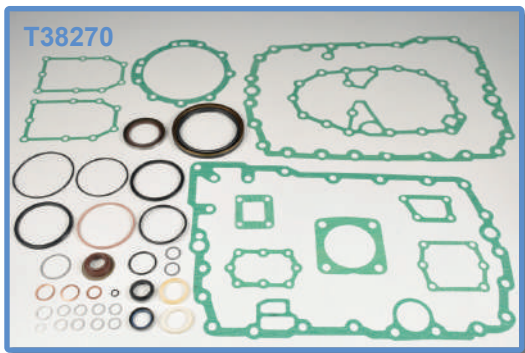

**T38270**

**Description:**

GASKET AND OIL SEAL KIT

**Packaging Unit:** 1

**OEM No :**

0091 298 001

**Model:**

8S 1350 KMZ

**EX / CROSS :**





**T38751**



**Description:**  
GASKET AND OIL SEAL KIT

**Packaging Unit:** 1

**OEM No :**  
1307 298 930

**Model:**  
S5 42  
S5 42 USA

**EX / CROSS :**  
1307 298 030

**T76353**

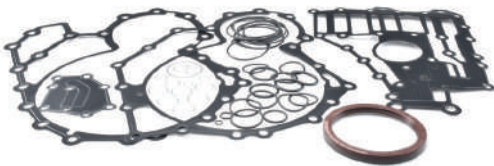

**Description:**  
GASKET AND OIL SEAL KIT

**Packaging Unit:** 1

**OEM No :**  
6085 298 036

**Model:**  
8S 180  
8S 2100

**EX / CROSS :**

**T45294**

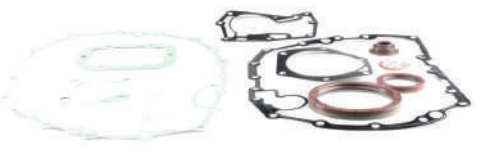

**Description:**  
GASKET AND OIL SEAL KIT FOR 9S-1110TO

**Packaging Unit:** 1

**OEM No :**  
TAS45294

**Model:**

**EX / CROSS :**  
(9S1110/G & S KIT)

**T94563**



**Description:**  
GASKET AND OIL SEAL KIT FOR VALVE ZF 0501 215 213

**Packaging Unit:** 1

**OEM No :**  
TAS94563

**Model:**  
16S 1650  
16S 2325TD  
16S 2520TO  
16S 2523TO  
16S 2525TO  
Ecosplit IV - 16 speed

**EX / CROSS :**

**T76346**



**Description:**  
GASKET AND OIL SEAL KIT INTARDER

**Packaging Unit:** 1

**OEM No :**  
6085 298 013

**Model:**  
16S 151  
16S 221  
Ecosplit III

**EX / CROSS :**



**T94566**

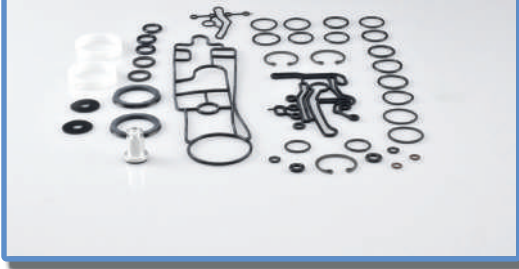

**Description:**

GASKET AND OIL SEAL SMALL KIT FOR VALVE ZF 0501 215 441

**Packaging Unit:** 1

**OEM No :**

TAS94566

**Model:**

16S 2220TD  
16S 2520TO

**EX / CROSS :**

**T94572**

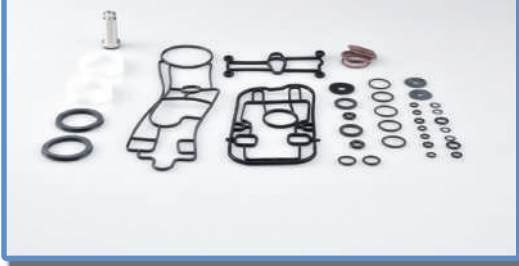

**Description:**

GASKET AND OIL SEAL SMALL KIT FOR VALVE ZF 0501 217 295

**Packaging Unit:** 1

**OEM No :**

TAS94572

**Model:**

16S 1650  
16S 2325TD  
16S 2520TO  
16S 2525TO

**EX / CROSS :**

**T75960**



**Description:**

GASKET AND OIL SEALS KIT INTARDER FOR ZF 16S151-221

**Packaging Unit:** 1

**OEM No :**

TAS75960

**Model:**

16S 151  
16S 221  
Ecosplit III

**EX / CROSS :**

**T75012**



**Description:**

GASKET KIT

**Packaging Unit:** 1

**OEM No :**

1290 298 905

**Model:**

S6 36

**EX / CROSS :**

**T76149**

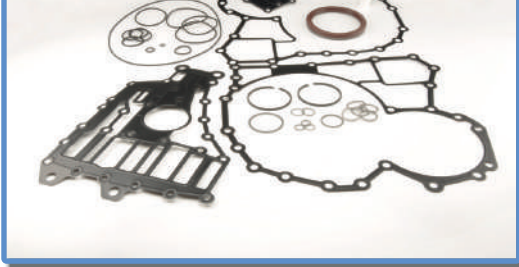

**Description:**

GASKET KIT

**Packaging Unit:** 1

**OEM No :**

6085 298 033

**Model:**

10AS 2010B IT	12AS 2301BO IT
10AS 2310B IT	12AS 2301IT
12AS 1601BO IT	12AS 2331TD IT
12AS 1631TD IT	12AS 2331TO IT
12AS 1800IT	12AS 2341TD IT
12AS 1931TD IT	12AS 2531TO IT
12AS 1931TO IT	12AS 2701BO IT
12AS 2000B IT	12AS 2741TO IT
12AS 2001BO IT	12AS 2941TO IT
12AS 2131TD IT	12AS 3001IT
12AS 2131TO IT	16AS 2200TD IT
12AS 2300B IT	16AS 2231TD IT

**EX / CROSS :**

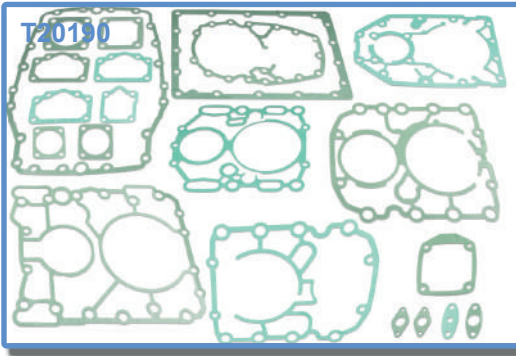

**T20190**

**Description:**  
GASKET KIT

**Packaging Unit:** 1

**OEM No :**  
1269 298 933

**Model:**

5K 110GP  
5K 110GP+GV90  
5K 110GPA  
5K 110GPA+GV90  
5S 110GP  
5S 110GP+GV90  
5S 110GPA  
5S 110GPA+GV90  
5S 111GP  
5S 111GP+GV90  
5S 111GPA

**EX / CROSS :**  
1269 298 932



**T57557**

**Description:**  
GASKET KIT

**Packaging Unit:** 1

**OEM No :**  
0501 323 922

**Model:**

10AS 2010B IT  
10AS 2300BO  
10AS 2310B  
10AS 2310B IT  
10AS 2700BO  
12AS 1210TO  
12AS 1220TD  
12AS 1420TD  
12AS 1420TO  
12AS 1601BO IT  
12AS 1620TO  
12AS 1630TD  
12AS 1631TD IT  
12AS 1930TD  
12AS 1930TO  
12AS 1931TD IT  
12AS 1931TO IT  
12AS 1935TD  
12AS 2000B IT  
12AS 2000BO  
12AS 2001BO IT  
12AS 2130TD  
12AS 2130TO  
12AS 2131TD IT

**EX / CROSS :**  
0501 319 864

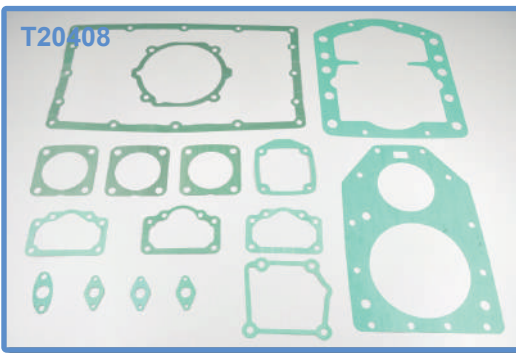

**T20408**

**Description:**  
GASKET KIT

**Packaging Unit:** 1

**OEM No :**  
1268 298 904

**Model:**

AK6 90  
AK6 90+GV90  
S6 90

**EX / CROSS :**

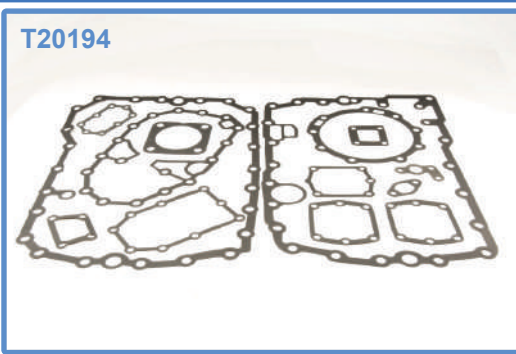

**T20194**

**Description:**  
GASKET KIT

**Packaging Unit:** 1

**OEM No :**  
1295 298 915

**Model:**

16S 112  
16S 112/1  
16S 130  
16S 130/1  
16S 150  
16S 160  
16S 160/1  
16S 190  
16S 190/1  
16S 220

**EX / CROSS :**  
1295 698 191  
0091 298 010  
0090 298 191

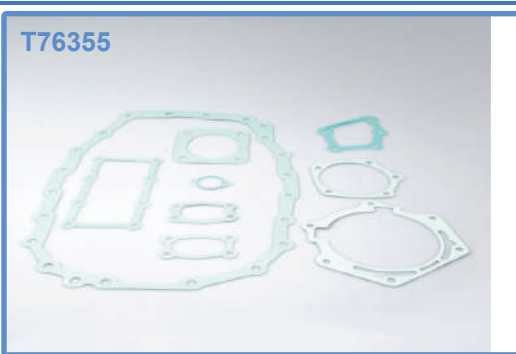

**T76355**

**Description:**  
GASKET KIT

**Packaging Unit:** 1

**OEM No :**  
1310 298 018

**Model:**

6S 1600  
6S 1600 KMZ  
6S 1600BD

**EX / CROSS :**



T75426

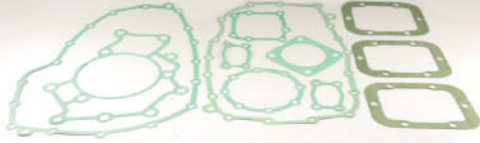

**Description:**  
GASKET KIT

**Packaging Unit:** 1

**OEM No :**  
1308 298 001

**Model:**  
9S 75

**EX / CROSS :**

T54497

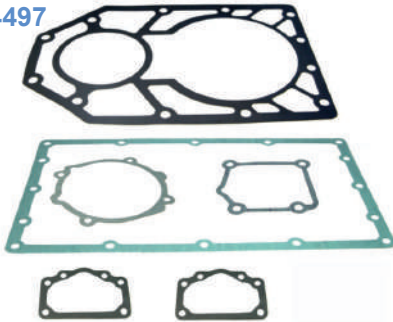

**Description:**  
GASKET KIT

**Packaging Unit:** 1

**OEM No :**  
1268 298 889

**Model:**  
S6 1550

**EX / CROSS :**  
0090 298 189

T76138



**Description:**  
GASKET KIT

**Packaging Unit:** 1

**OEM No :**  
1325 298 009

**Model:**  
16S 151  
Ecosplit III

**EX / CROSS :**

T93874

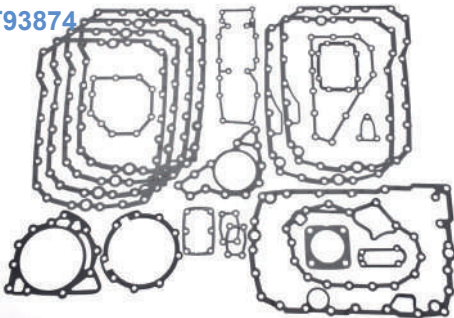

**Description:**  
GASKET KIT - PAPER

**Packaging Unit:** 1

**OEM No :**  
1315 298 001P

**Model:**  
16S 151  
16S 181  
16S 221  
16S 251  
Ecosplit III

**EX / CROSS :**

T49361

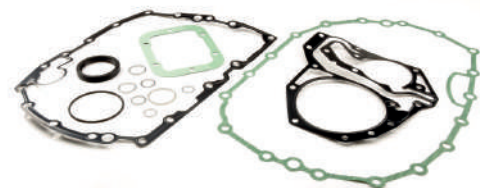

**Description:**  
GASKET KIT 9S 1110

**Packaging Unit:** 1

**OEM No :**  
1324 298 014

**Model:**

**EX / CROSS :**

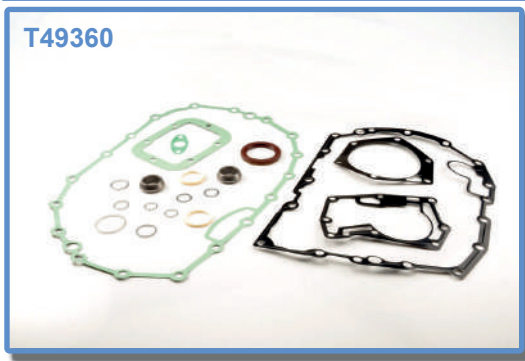

**T49360**

**Description:**  
GASKET KIT 9S 1110

**Packaging Unit:** 1

**OEM No :**  
1324 298 013

**Model:**  
9S 1110TO

**EX / CROSS :**

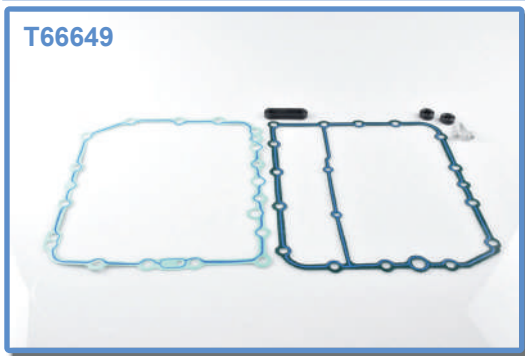

**T66649**

**Description:**  
GASKET KIT COMPLETE GS3 ASTRONIC

**Packaging Unit:**

**OEM No :**  
TAS66649

**Model:**

**EX / CROSS :**



**T49492**

**Description:**  
GASKET KIT FOR ECOMID

**Packaging Unit:** 1

**OEM No :**  
1304 298 914

**Model:**  
16S 109  
6S 150C  
8S 109  
8S 140  
8S 180  
8S 2100  
9S 109

**EX / CROSS :**  
1304 298 902



**T51899**

**Description:**  
GASKET KIT FOR ECOMID

**Packaging Unit:** 1

**OEM No :**  
1324 298 001

**Model:**  
9S 1110

**EX / CROSS :**  
TAS51899

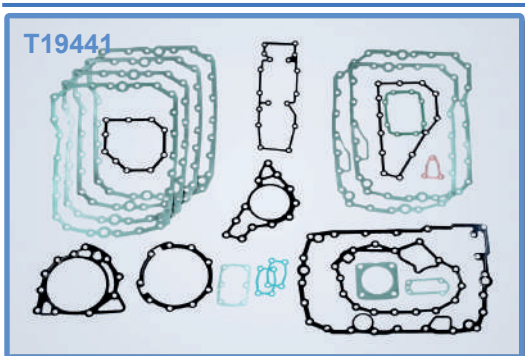

**T19441**

**Description:**  
GASKET KIT VICTOR REINZ

**Packaging Unit:** 1

**OEM No :**  
1315 298 001

**Model:**  
16S 151  
16S 151 DAF  
16S 151 HYU  
16S 151 KMZ  
16S 151 MAN  
16S 151 RVI  
16S 151 SNVI  
16S 181  
16S 221  
16S 2280TO  
16S 251  
Ecosplit III

**EX / CROSS :**

<p><b>T08587</b></p> 	<p><b>Description:</b> GEAR (25-25T.)</p> <p><b>OEM No :</b> 1250 312 161</p> <p><b>EX / CROSS :</b></p>	<p><b>Packaging Unit:</b> 1</p> <p><b>Model:</b></p>
<p><b>T51662</b></p> 	<p><b>Description:</b> GEAR (29T.)</p> <p><b>OEM No :</b> 6085 301 012</p> <p><b>EX / CROSS :</b></p>	<p><b>Packaging Unit:</b> 1</p> <p><b>Model:</b> 16S 1621TD IT 16S 1821TO IT 16S 1921TD IT 16S 2221TD IT 16S 2221TO IT 16S 2321TD IT 16S 2521TO IT 16S 2721TO IT 16S 272TO IT 8S 1621TD IT 8S 1821TO IT</p>
<p><b>T08448</b></p> 	<p><b>Description:</b> GEAR (31-25T.)</p> <p><b>OEM No :</b> 1268 312 003</p> <p><b>EX / CROSS :</b></p>	<p><b>Packaging Unit:</b> 1</p> <p><b>Model:</b></p>
<p><b>T08478</b></p> 	<p><b>Description:</b> GEAR (42-25T.)</p> <p><b>OEM No :</b> 1269 312 005</p> <p><b>EX / CROSS :</b></p>	<p><b>Packaging Unit:</b> 1</p> <p><b>Model:</b></p>
<p><b>T08912</b></p> 	<p><b>Description:</b> GEAR (43T.)</p> <p><b>OEM No :</b> 1269 312 049</p> <p><b>EX / CROSS :</b> 1269 312 006 1269 312 018 1269 312 025 1269 312 047</p>	<p><b>Packaging Unit:</b> 1</p> <p><b>Model:</b></p>



<p><b>T08466</b></p>	<p><b>Description:</b> GEAR (45T.)</p> <p><b>OEM No :</b> 1250 312 270</p> <p><b>EX / CROSS :</b> 1250 312 159 1250 312 162 1250 312 239</p>	<p><b>Packaging Unit:</b> 1</p> <p><b>Model:</b></p>
<p><b>T08864</b></p>	<p><b>Description:</b> GEAR (54T.)</p> <p><b>OEM No :</b> 1268 312 055</p> <p><b>EX / CROSS :</b></p>	<p><b>Packaging Unit:</b> 1</p> <p><b>Model:</b></p>
<p><b>T08855</b></p>	<p><b>Description:</b> GEAR (54T.)</p> <p><b>OEM No :</b> 1268 312 052</p> <p><b>EX / CROSS :</b> 1268 312 025</p>	<p><b>Packaging Unit:</b> 1</p> <p><b>Model:</b></p>
<p><b>T60913</b></p>	<p><b>Description:</b> GEAR 4TH SPEED 27 T</p> <p><b>OEM No :</b> 1304 304 516</p> <p><b>EX / CROSS :</b></p>	<p><b>Packaging Unit:</b></p> <p><b>Model:</b> 16S 109 8S 109</p>
<p><b>T61662</b></p>	<p><b>Description:</b> GEARBOX REDUCTION SIDE PINION</p> <p><b>OEM No :</b> 1328 332 022</p> <p><b>EX / CROSS :</b></p>	<p><b>Packaging Unit:</b></p> <p><b>Model:</b> 12AS 1930TO 12AS 1931TD IT 12AS 1931TO IT 12AS 1935TD 12AS 2000B IT 12AS 2000BO 12AS 2001BO IT 12AS 2130TD 12AS 2140TD 12AS 2330TD 12AS 2335TD 16AS 2200TD</p> <p>16AS 2230TD 16AS 2630TO 16AS 2631TO IT 16AS 2635TO</p>



<p><b>T15366</b></p> 	<p><b>Description:</b> GROOVED NUT</p> <p><b>OEM No :</b> 0501 398 371</p> <p><b>EX / CROSS :</b> 0737 502 092</p>	<p><b>Packaging Unit:</b> 1</p> <p><b>Model:</b></p>
<p><b>T41363</b></p> 	<p><b>Description:</b> INPUT SHAFT</p> <p><b>OEM No :</b> 1346 302 081</p> <p><b>EX / CROSS :</b></p>	<p><b>Packaging Unit:</b> 1</p> <p><b>Model:</b> 6AS 1010 BO S6 1010 BO</p>
<p><b>T63679</b></p> 	<p><b>Description:</b> INPUT SHAFT</p> <p><b>OEM No :</b> 1310 302 089</p> <p><b>EX / CROSS :</b></p>	<p><b>Packaging Unit:</b> 1</p> <p><b>Model:</b> 6S 1900BO 6S 1901BO IT</p>
<p><b>T57339</b></p> 	<p><b>Description:</b> INPUT SHAFT</p> <p><b>OEM No :</b> 1328 302 078</p> <p><b>EX / CROSS :</b> 1328 302 071</p>	<p><b>Packaging Unit:</b> 1</p> <p><b>Model:</b> 10AS 2010B IT 10AS 2310B IT 12AS 1601BO IT 12AS 1630TD 12AS 1631TD IT 12AS 1930TD 12AS 1930TO 12AS 1931TD IT 12AS 1931TO IT 12AS 2000B IT 12AS 2000BO 12AS 2001BO IT 12AS 2130TD 12AS 2130TO 12AS 2131TD IT 12AS 2131TO IT</p>
<p><b>T57337</b></p> 	<p><b>Description:</b> INPUT SHAFT</p> <p><b>OEM No :</b> 1328 302 077</p> <p><b>EX / CROSS :</b> 1328 302 070</p>	<p><b>Packaging Unit:</b> 1</p> <p><b>Model:</b> 12AS 1630TD 12AS 1631TD IT 12AS 1930TD 12AS 1930TO 12AS 1931TD IT 12AS 1931TO IT 12AS 1935TD 12AS 2001BO IT 12AS 2130TD 12AS 2130TO 12AS 2131TD IT 12AS 2131TO IT 12AS 2301 12AS 2301BO IT 12AS 2301IT 12AS 2330TD 12AS 2330TO 12AS 2331TD IT 12AS 2331TO IT 12AS 2335TD 12AS 2335TO 12AS 2530TO 12AS 2531TO IT 16AS 2230TD</p>





T62193



**Description:**  
INPUT SHAFT

**Packaging Unit:**

**OEM No :**  
1315 221 002

**Model:**  
16S 151  
16S 1822TO  
16S 1825TO

**EX / CROSS :**

T46524



**Description:**  
INPUT SHAFT

**Packaging Unit:** 1

**OEM No :**  
1346 302 054

**Model:**  
6AS 1000TO  
6S 1000TO  
6S 1010BO  
AS Tronic

**EX / CROSS :**

T20790



**Description:**  
INPUT SHAFT

**Packaging Unit:** 1

**OEM No :**  
5841 302 094

**Model:**

**EX / CROSS :**

T15444



**Description:**  
INPUT SHAFT (18-28-10T.)

**Packaging Unit:** 1

**OEM No :**  
1268 302 095

**Model:**

**EX / CROSS :**

T18437



**Description:**  
INPUT SHAFT (18-34-10T.)

**Packaging Unit:** 1

**OEM No :**  
1269 298 938

**Model:**

**EX / CROSS :**  
1269 302 230



T18589



**Description:**  
INPUT SHAFT (18-34-21T.)

**Packaging Unit:** 1

**OEM No :**  
1269 298 939

**Model:**

**EX / CROSS :**  
1269 298 904  
1269 298 944  
1269 302 089  
1269 302 168

T20305



**Description:**  
INPUT SHAFT (19-19T.)

**Packaging Unit:** 1

**OEM No :**  
1250 302 258

**Model:**  
AK6 80  
S6 80

**EX / CROSS :**

T08339



**Description:**  
INPUT SHAFT (19-19T.)

**Packaging Unit:** 1

**OEM No :**  
1250 302 196

**Model:**

**EX / CROSS :**

T09761



**Description:**  
INPUT SHAFT (19-25-10T.)

**Packaging Unit:** 1

**OEM No :**  
1268 302 047

**Model:**

**EX / CROSS :**  
1268 302 007

T18443



**Description:**  
INPUT SHAFT (19-29-10T.)

**Packaging Unit:** 1

**OEM No :**  
1268 302 132

**Model:**

**EX / CROSS :**  
1268 302 015



T70013



**Description:**  
INPUT SHAFT (19T.)

**Packaging Unit:** 1

**OEM No :**  
1290 302 524

**Model:**  
6S 850  
6S 890

**EX / CROSS :**  
1290 302 465

T77004



**Description:**  
INPUT SHAFT (19T.)

**Packaging Unit:** 1

**OEM No :**  
1290 302 511

**Model:**  
6S 850

**EX / CROSS :**  
1290 302 396

T77080



**Description:**  
INPUT SHAFT (21T.)

**Packaging Unit:** 1

**OEM No :**  
1346 302 047

**Model:**  
6AS 1000TO  
6AS 1005TO  
6S 1000TO  
6S 1005TO  
AS Tronic

**EX / CROSS :**

T10923



**Description:**  
INPUT SHAFT (22-18T.)

**Packaging Unit:** 1

**OEM No :**  
1238 302 188

**Model:**

**EX / CROSS :**

T08573



**Description:**  
INPUT SHAFT (23-19T.)

**Packaging Unit:** 1

**OEM No :**  
1250 302 199

**Model:**

**EX / CROSS :**



T16608



**Description:**  
INPUT SHAFT (25-19-10T.)

**Packaging Unit:** 1

**OEM No :**  
1268 302 126

**Model:**

**EX / CROSS :**

T08997



**Description:**  
INPUT SHAFT (25-19-10T.)

**Packaging Unit:** 1

**OEM No :**  
1268 302 104

**Model:**

**EX / CROSS :**

T18457



**Description:**  
INPUT SHAFT (25-19T.)

**Packaging Unit:** 1

**OEM No :**  
1268 302 049

**Model:**  
AK6 90  
S6 90  
S6 90/1

**EX / CROSS :**

T08464



**Description:**  
INPUT SHAFT (25-19T.)

**Packaging Unit:** 1

**OEM No :**  
1268 302 001

**Model:**

**EX / CROSS :**

T72388



**Description:**  
INPUT SHAFT (26T.)

**Packaging Unit:** 1

**OEM No :**  
1304 202 168

**Model:**  
9S 109

**EX / CROSS :**  
1304 202 061  
1304 202 103  
1304 302 384



T81217



**Description:**  
INPUT SHAFT (26T.)

**Packaging Unit:** 1

**OEM No :**  
1308 202 052

**Model:**  
9S 75

**EX / CROSS :**  
1308 202 038  
1308 302 096

T15198



**Description:**  
INPUT SHAFT (27-19T.)

**Packaging Unit:** 1

**OEM No :**  
1246 302 073

**Model:**  
S6 65  
S6 65+GV80

**EX / CROSS :**  
1246 302 054

T15202



**Description:**  
INPUT SHAFT (27-19T.)

**Packaging Unit:** 1

**OEM No :**  
1250 302 260

**Model:**  
S6 80/1

**EX / CROSS :**

T81218



**Description:**  
INPUT SHAFT (27T.)

**Packaging Unit:** 1

**OEM No :**  
1310 302 026

**Model:**  
6S 1000BD  
6S 1200BD  
S6 85

**EX / CROSS :**

T53562



**Description:**  
INPUT SHAFT (27T.)

**Packaging Unit:** 1

**OEM No :**  
1307 202 163

**Model:**  
S5 42

**EX / CROSS :**  
1307 202 154  
1307 202 140



T50173



**Description:**  
INPUT SHAFT (27T.)

**Packaging Unit:** 1

**OEM No :**  
1304 202 245

**Model:**  
9S 109

**EX / CROSS :**  
1304 302 473

T09041



**Description:**  
INPUT SHAFT (28-46T.)

**Packaging Unit:** 1

**OEM No :**  
1268 302 164

**Model:**  
S6 90  
S6 90 SETRA

**EX / CROSS :**

T58555



**Description:**  
INPUT SHAFT (28T.)

**Packaging Unit:** 1

**OEM No :**  
0091 302 097

**Model:**  
S6 1550

**EX / CROSS :**

T08462



**Description:**  
INPUT SHAFT (29-19T.)

**Packaging Unit:** 1

**OEM No :**  
1268 302 042

**Model:**

**EX / CROSS :**

T38433



**Description:**  
INPUT SHAFT (29-51T.)

**Packaging Unit:** 1

**OEM No :**  
1310 302 001

**Model:**  
6S 1200BO  
6S 1200BO IKA  
6S 1200BO KMZ  
6S 1200TO  
S6 85  
S6 85 MAN

**EX / CROSS :**



T14805



**Description:**  
INPUT SHAFT (30-10T.)

**Packaging Unit:** 1

**OEM No :**  
1269 212 006

**Model:**

**EX / CROSS :**  
1269 312 010

T09216



**Description:**  
INPUT SHAFT (30-10T.)

**Packaging Unit:** 1

**OEM No :**  
1285 212 005

**Model:**

**EX / CROSS :**  
1285 312 005  
1285 312 011

T09040



**Description:**  
INPUT SHAFT (30-10T.)

**Packaging Unit:** 1

**OEM No :**  
1250 312 291

**Model:**

**EX / CROSS :**  
1250 312 220

AK6 65+GV80  
AK6 80+GV80  
AK6 90  
AK6 90+GV90  
GV 90-AK  
GV 90-S  
S6 65+GV80  
S6 80+GV80  
S6 80/1+GV80  
S6 90  
S6 90+GV90  
S6 90/1+GV90

T08920



**Description:**  
INPUT SHAFT (30-10T.)

**Packaging Unit:** 1

**OEM No :**  
1250 312 247

**Model:**

**EX / CROSS :**  
1268 312 013

T08948



**Description:**  
INPUT SHAFT (30-10T.)

**Packaging Unit:** 1

**OEM No :**  
1250 312 171

**Model:**

**EX / CROSS :**



T10416



**Description:**  
INPUT SHAFT (30T.)

**Packaging Unit:** 1

**OEM No :**  
1268 312 113

**Model:**

**EX / CROSS :**

T08934



**Description:**  
INPUT SHAFT (33-19T.)

**Packaging Unit:** 1

**OEM No :**  
1272 298 918

**Model:**

**EX / CROSS :**  
1272 302 112

T08897



**Description:**  
INPUT SHAFT (33-19T.)

**Packaging Unit:** 1

**OEM No :**  
1272 298 904

**Model:**

**EX / CROSS :**  
1272 298 901  
1272 302 032

T08505



**Description:**  
INPUT SHAFT (33-19T.)

**Packaging Unit:** 1

**OEM No :**  
1272 298 909

**Model:**

**EX / CROSS :**  
1272 302 095

T08447



**Description:**  
INPUT SHAFT (34-18T.)

**Packaging Unit:** 1

**OEM No :**  
1269 298 942

**Model:**

**EX / CROSS :**  
1269 298 927  
1269 302 213



<p><b>T08445</b></p> 	<p><b>Description:</b> INPUT SHAFT (34-18T.)</p> <p><b>OEM No :</b> 1269 202 913</p> <p><b>EX / CROSS :</b> 1269 202 909 1269 202 912 1269 298 941 1269 302 094</p>	<p><b>Packaging Unit:</b> 1</p> <p><b>Model:</b></p>
<p><b>T10118</b></p> 	<p><b>Description:</b> INPUT SHAFT (34-60T.)</p> <p><b>OEM No :</b> 1307 202 041</p> <p><b>EX / CROSS :</b> 1307 202 123 1307 202 006</p>	<p><b>Packaging Unit:</b> 1</p> <p><b>Model:</b></p>
<p><b>T76676</b></p> 	<p><b>Description:</b> INPUT SHAFT (48T.)</p> <p><b>OEM No :</b> 1304 202 203</p> <p><b>EX / CROSS :</b> 1304 202 115 1304 302 405</p>	<p><b>Packaging Unit:</b> 1</p> <p><b>Model:</b> 16S 109</p>
<p><b>T22686</b></p> 	<p><b>Description:</b> INPUT SHAFT (50-19-10T.)</p> <p><b>OEM No :</b> 1290 302 507</p> <p><b>EX / CROSS :</b> 1290 302 482</p>	<p><b>Packaging Unit:</b> 1</p> <p><b>Model:</b> 6S 700BO 6S 700BO KAVZ 6S 850 6S 890</p>
<p><b>T15119</b></p> 	<p><b>Description:</b> INPUT SHAFT (57-10T.)</p> <p><b>OEM No :</b> 1296 202 004</p> <p><b>EX / CROSS :</b> 1296 302 033</p>	<p><b>Packaging Unit:</b> 1</p> <p><b>Model:</b></p>

<p><b>T09793</b></p> 	<p><b>Description:</b> INPUT SHAFT (57-10T.)</p> <p><b>OEM No :</b> 1295 202 004</p> <p><b>EX / CROSS :</b> 1295 298 910 1295 302 086</p>	<p><b>Packaging Unit:</b> 1</p> <p><b>Model:</b></p>
<p><b>T11173</b></p> 	<p><b>Description:</b> INPUT SHAFT (57-10T.)</p> <p><b>OEM No :</b> 1296 202 001</p> <p><b>EX / CROSS :</b> 1296 302 007</p>	<p><b>Packaging Unit:</b> 1</p> <p><b>Model:</b></p>
<p><b>T09791</b></p> 	<p><b>Description:</b> INPUT SHAFT (57-10T.)</p> <p><b>OEM No :</b> 1297 202 030</p> <p><b>EX / CROSS :</b> 1297 202 005 1297 302 160</p>	<p><b>Packaging Unit:</b> 1</p> <p><b>Model:</b></p>
<p><b>T15053</b></p> 	<p><b>Description:</b> INPUT SHAFT (57-10T.)</p> <p><b>OEM No :</b> 1297 202 053</p> <p><b>EX / CROSS :</b> 1297 202 013 1297 202 038 1297 302 173 1297 302 231</p>	<p><b>Packaging Unit:</b> 1</p> <p><b>Model:</b></p>
<p><b>T11171</b></p> 	<p><b>Description:</b> INPUT SHAFT (57-10T.)</p> <p><b>OEM No :</b> 1295 202 028</p> <p><b>EX / CROSS :</b> 1295 302 158</p>	<p><b>Packaging Unit:</b> 1</p> <p><b>Model:</b></p>



**T57537**



**Description:**  
INPUT SHAFT 26T.

**Packaging Unit:**

**OEM No :**  
1304 302 388

**Model:**

**EX / CROSS :**  
1304 202 177

**T57529**



**Description:**  
INPUT SHAFT 28 T

**Packaging Unit:**

**OEM No :**  
1304 202 190

**Model:**

**EX / CROSS :**  
1304 302 415

**T94081**



**Description:**  
INPUT SHAFT ASSEMBLY

**Packaging Unit: 1**

**OEM No :**  
1315 202 071

**Model:**

**EX / CROSS :**  
1355 302 014

**T37664**



**Description:**  
INPUT SHAFT ASSEMBLY (27T.)

**Packaging Unit: 1**

**OEM No :**  
1307 202 168

**Model:**  
S5 42  
S5 42 KMZ  
S5 42 MAZ

**EX / CROSS :**  
1307 202 166

**T54510**



**Description:**  
INPUT SHAFT ASSEMBLY (29T.)

**Packaging Unit: 1**

**OEM No :**  
1304 202 208

**Model:**  
8S 180  
8S 2100  
8S 2100BD  
8S 2100BO  
8S 2101BD IT  
8S 2101BO IT

**EX / CROSS :**  
1304 302 430

<p><b>T20710</b></p> 	<p><b>Description:</b> INPUT SHAFT ASSEMBLY (32-48T.)</p> <p><b>OEM No :</b> 1324 302 029</p> <p><b>EX / CROSS :</b> 1324 202 014</p>	<p><b>Packaging Unit:</b> 1</p> <p><b>Model:</b> 9S 1310TO 9S 1310TO KMZ 9S 1315TO</p>
<p><b>T38334</b></p> 	<p><b>Description:</b> INPUT SHAFT ASSEMBLY (36-58T.)</p> <p><b>OEM No :</b> 1316 202 037</p> <p><b>EX / CROSS :</b> 1316 302 087</p>	<p><b>Packaging Unit:</b> 1</p> <p><b>Model:</b> 16S 221 16S 221 MB 16S 251 NIS Ecosplit III</p>
<p><b>T17692</b></p> 	<p><b>Description:</b> INPUT SHAFT ASSEMBLY (57-10T.)</p> <p><b>OEM No :</b> 1315 202 037</p> <p><b>EX / CROSS :</b> 1315 302 153 1315 302 214 1355 302 002</p>	<p><b>Packaging Unit:</b> 1</p> <p><b>Model:</b> 16S 151 16S 151 DAF 16S 151 KMZ 16S 151 MAN 16S 151 RVI 16S 151 SNVI 16S 151IT DAF 16S 1620TD 16S 1621TD IT 16S 1625TD 16S 162TD IT 16S 1631TD IT</p> <p>16S 163TD IT 16S 1820TO 16S 1820TO KMZ 16S 1821TO IT 16S 182TO IT 8S 151 8S 151 DAF 8S 1620TD 8S 1621TD IT 8S 162TD IT 8S 1820TO 8S 1821TO IT</p>
<p><b>T38332</b></p> 	<p><b>Description:</b> INPUT SHAFT ASSEMBLY (57-10T.)</p> <p><b>OEM No :</b> 1315 202 039</p> <p><b>EX / CROSS :</b> 1315 302 163</p>	<p><b>Packaging Unit:</b> 1</p> <p><b>Model:</b> 16S 151 16S 151 DAF 16S 151 HIN 16S 151 HYU 16S 151 RVI 16S 151 SNVI Ecosplit III</p>
<p><b>T20227</b></p> 	<p><b>Description:</b> INPUT SHAFT ASSEMBLY (57-10T.)</p> <p><b>OEM No :</b> 1315 202 040</p> <p><b>EX / CROSS :</b> 1315 302 162 1315 302 217 1355 302 005</p>	<p><b>Packaging Unit:</b> 1</p> <p><b>Model:</b> 16S 151 16S 151 IVE 16S 151PTO HIN 16S 1620TD 16S 1625TD 16S 1630TD 16S 1631TD IT 16S 163TD IT Ecosplit III Ecosplit IV - 16 speed</p>



<p><b>T11730</b></p> 	<p><b>Description:</b> INPUT SHAFT ASSEMBLY (57-10T.)</p> <p><b>OEM No :</b> 1313 202 013</p> <p><b>EX / CROSS :</b> 1313 302 030</p>	<p><b>Packaging Unit:</b> 1</p> <p><b>Model:</b> 16S 150</p>
<p><b>T19096</b></p> 	<p><b>Description:</b> INPUT SHAFT ASSEMBLY (57-10T.)</p> <p><b>OEM No :</b> 1295 202 019</p> <p><b>EX / CROSS :</b> 1295 202 001 1295 302 129</p>	<p><b>Packaging Unit:</b> 1</p> <p><b>Model:</b> 16S 130</p>
<p><b>T17603</b></p> 	<p><b>Description:</b> INPUT SHAFT ASSEMBLY (57-10T.)</p> <p><b>OEM No :</b> 1315 202 022</p> <p><b>EX / CROSS :</b> 1315 302 043 1315 302 086</p>	<p><b>Packaging Unit:</b> 1</p> <p><b>Model:</b> 16S 151 Ecosplit III</p>
<p><b>T71619</b></p> 	<p><b>Description:</b> INPUT SHAFT ASSEMBLY (57T.)</p> <p><b>OEM No :</b> 1316 202 043</p> <p><b>EX / CROSS :</b> 1316 302 209 1356 302 114</p>	<p><b>Packaging Unit:</b> 1</p> <p><b>Model:</b> Ecosplit III Ecosplit IV - 16 speed</p>
<p><b>T60321</b></p> 	<p><b>Description:</b> INPUT SHAFT ASSEMBLY (57T.)</p> <p><b>OEM No :</b> 1315 202 038</p> <p><b>EX / CROSS :</b> 1315 302 164 1315 302 215 1355 302 003</p>	<p><b>Packaging Unit:</b> 1</p> <p><b>Model:</b> 16S 151 16S 1620TD 16S 162TD IT 16S 1820TO 16S 1821TO IT 16S 182TO IT 16S 1830TO 16S 1831TO IT 16S 1835TO 16S 183TO IT Ecosplit III Ecosplit IV - 16 speed</p>

<p><b>T94385</b></p> 	<p><b>Description:</b> INPUT SHAFT ASSEMBLY (57T.)</p> <p><b>OEM No :</b> 1315 202 070</p> <p><b>EX / CROSS :</b> 1355 302 012</p>	<p><b>Packaging Unit:</b> 1</p> <p><b>Model:</b> 16S 1625TD</p>
<p><b>T17909</b></p> 	<p><b>Description:</b> INPUT SHAFT ASSEMBLY (57T.)</p> <p><b>OEM No :</b> 1316 202 025</p> <p><b>EX / CROSS :</b> 1316 302 085 1316 302 226 1356 302 100</p>	<p><b>Packaging Unit:</b> 1</p> <p><b>Model:</b> 16S 181 16S 181 MAN 16S 181IT DAF 16S 1920TD 16S 1921TD IT 16S 1930TD 16S 1931TD IT 16S 193TD IT 16S 221 16S 221 DAF 16S 221 MAN 16S 221 RVI 16S 2220TD 16S 2220TO 16S 2220TO IT 16S 2221TD IT 16S 2221TO IT 16S 2225TD 16S 2225TO 16S 2225TO IT 16S 2230TD 16S 2230TO 16S 2230TO IT 16S 2231TD IT 16S 2235TD 16S 223TD IT 16S 223TO IT</p>
<p><b>T20471</b></p> 	<p><b>Description:</b> INPUT SHAFT ASSEMBLY (57T.)</p> <p><b>OEM No :</b> 1316 202 026</p> <p><b>EX / CROSS :</b> 1316 302 014 1316 302 079 1316 302 103 1316 302 221</p>	<p><b>Packaging Unit:</b> 1</p> <p><b>Model:</b> 16S 181 16S 181 IVE 16S 1920TD 16S 1921TD IT 16S 1925TD 16S 1930TD 16S 193TD IT 16S 221 16S 221 IVE 16S 221 VW 16S 221IT IVE 16S 2220TD 16S 2220TO 16S 2220TO IT 16S 2221TD IT 16S 2221TO IT 16S 2225TD 16S 2225TO 16S 2230TD 16S 2230TO 16S 2230TO IT 16S 2231TD IT 16S 2235TD 16S 223TD IT 16S 223TO IT</p>
<p><b>T37665</b></p> 	<p><b>Description:</b> INPUT SHAFT ASSEMBLY (64-24-10T.)</p> <p><b>OEM No :</b> 1307 202 169</p> <p><b>EX / CROSS :</b> 1307 202 167</p>	<p><b>Packaging Unit:</b> 1</p> <p><b>Model:</b> 5S 600BO S5 42 KAVZ</p>
<p><b>T39079</b></p> 	<p><b>Description:</b> INPUT SHAFT ASSEMBLY (64-27-10T.)</p> <p><b>OEM No :</b> 1307 202 150</p> <p><b>EX / CROSS :</b> 1307 202 149</p>	<p><b>Packaging Unit:</b> 1</p> <p><b>Model:</b> S5 42 S5 42 SNVI</p>



T50153



**Description:**  
INPUT SHAFT ASSY (57T.)

**Packaging Unit:** 1

**OEM No :**  
0091 202 028

**Model:**  
16S 1650

**EX / CROSS :**  
0091 302 173

T08589



**Description:**  
INTERMEDIATE SHAFT (19-19-30T.)

**Packaging Unit:** 1

**OEM No :**  
1250 312 126

**Model:**

**EX / CROSS :**  
1250 312 127

T08526



**Description:**  
INTERMEDIATE SHAFT (25-19-30T.)

**Packaging Unit:** 1

**OEM No :**  
1268 312 124

**Model:**

**EX / CROSS :**  
1268 312 005

T15872



**Description:**  
INTERMEDIATE SHAFT (30-25-19T.)

**Packaging Unit:** 1

**OEM No :**  
1268 312 102

**Model:**

**EX / CROSS :**

T08923



**Description:**  
INTERMEDIATE SHAFT (34-18-30T.)





**Packaging Unit:** 1

**OEM No :**  
1269 298 909

**Model:**

**EX / CROSS :**  
1269 212 025  
1269 212 901  
1269 312 017  
1269 312 028



<p><b>T57423</b></p> 	<p><b>Description:</b> KEY</p> <p><b>OEM No :</b> 1328 304 035</p> <p><b>EX / CROSS :</b></p>	<p><b>Packaging Unit:</b> 1</p> <p><b>Model:</b></p> <table border="0"> <tr> <td>10AS 2010B IT</td> <td>12AS 1935TD</td> </tr> <tr> <td>10AS 2300BO</td> <td>12AS 2000B IT</td> </tr> <tr> <td>10AS 2310B</td> <td>12AS 2000BO</td> </tr> <tr> <td>10AS 2310B IT</td> <td>12AS 2001BO IT</td> </tr> <tr> <td>10AS 2700BO</td> <td>12AS 2130TD</td> </tr> <tr> <td>12AS 1601BO IT</td> <td>12AS 2130TO</td> </tr> <tr> <td>12AS 1630TD</td> <td>12AS 2131TD IT</td> </tr> <tr> <td>12AS 1631TD IT</td> <td>12AS 2131TO IT</td> </tr> <tr> <td>12AS 1930TD</td> <td>12AS 2300B IT</td> </tr> <tr> <td>12AS 1930TO</td> <td>12AS 2300BO</td> </tr> <tr> <td>12AS 1931TD IT</td> <td>12AS 2301</td> </tr> <tr> <td>12AS 1931TO IT</td> <td>12AS 2301BO IT</td> </tr> </table>	10AS 2010B IT	12AS 1935TD	10AS 2300BO	12AS 2000B IT	10AS 2310B	12AS 2000BO	10AS 2310B IT	12AS 2001BO IT	10AS 2700BO	12AS 2130TD	12AS 1601BO IT	12AS 2130TO	12AS 1630TD	12AS 2131TD IT	12AS 1631TD IT	12AS 2131TO IT	12AS 1930TD	12AS 2300B IT	12AS 1930TO	12AS 2300BO	12AS 1931TD IT	12AS 2301	12AS 1931TO IT	12AS 2301BO IT
10AS 2010B IT	12AS 1935TD																									
10AS 2300BO	12AS 2000B IT																									
10AS 2310B	12AS 2000BO																									
10AS 2310B IT	12AS 2001BO IT																									
10AS 2700BO	12AS 2130TD																									
12AS 1601BO IT	12AS 2130TO																									
12AS 1630TD	12AS 2131TD IT																									
12AS 1631TD IT	12AS 2131TO IT																									
12AS 1930TD	12AS 2300B IT																									
12AS 1930TO	12AS 2300BO																									
12AS 1931TD IT	12AS 2301																									
12AS 1931TO IT	12AS 2301BO IT																									
<p><b>T08924</b></p> 	<p><b>Description:</b> LEVER</p> <p><b>OEM No :</b> 1285 334 023</p> <p><b>EX / CROSS :</b> 1285 334 017 1285 334 021</p>	<p><b>Packaging Unit:</b> 1</p> <p><b>Model:</b></p>																								
<p><b>T15890</b></p> 	<p><b>Description:</b> LEVER</p> <p><b>OEM No :</b> 1240 307 338</p> <p><b>EX / CROSS :</b></p>	<p><b>Packaging Unit:</b> 1</p> <p><b>Model:</b></p>																								
<p><b>T16559</b></p> 	<p><b>Description:</b> LEVER</p> <p><b>OEM No :</b> 1250 307 572</p> <p><b>EX / CROSS :</b></p>	<p><b>Packaging Unit:</b> 1</p> <p><b>Model:</b></p>																								
<p><b>T57438</b></p> 	<p><b>Description:</b> LOCK RING</p> <p><b>OEM No :</b> 0730 302 523</p> <p><b>EX / CROSS :</b> 0730 513 682</p>	<p><b>Packaging Unit:</b> 1</p> <p><b>Model:</b></p> <table border="0"> <tr> <td>10AS 2010B IT</td> <td>12AS 1935TD</td> </tr> <tr> <td>10AS 2300BO</td> <td>12AS 2000B IT</td> </tr> <tr> <td>10AS 2310B</td> <td>12AS 2000BO</td> </tr> <tr> <td>10AS 2310B IT</td> <td>12AS 2001BO IT</td> </tr> <tr> <td>10AS 2700BO</td> <td>12AS 2130TD</td> </tr> <tr> <td>12AS 1601BO IT</td> <td>12AS 2130TO</td> </tr> <tr> <td>12AS 1630TD</td> <td>12AS 2131TD IT</td> </tr> <tr> <td>12AS 1631TD IT</td> <td>12AS 2131TO IT</td> </tr> <tr> <td>12AS 1930TD</td> <td>12AS 2140TD</td> </tr> <tr> <td>12AS 1930TO</td> <td>12AS 2300B IT</td> </tr> <tr> <td>12AS 1931TD IT</td> <td>12AS 2300BO</td> </tr> <tr> <td>12AS 1931TO IT</td> <td>12AS 2301</td> </tr> </table>	10AS 2010B IT	12AS 1935TD	10AS 2300BO	12AS 2000B IT	10AS 2310B	12AS 2000BO	10AS 2310B IT	12AS 2001BO IT	10AS 2700BO	12AS 2130TD	12AS 1601BO IT	12AS 2130TO	12AS 1630TD	12AS 2131TD IT	12AS 1631TD IT	12AS 2131TO IT	12AS 1930TD	12AS 2140TD	12AS 1930TO	12AS 2300B IT	12AS 1931TD IT	12AS 2300BO	12AS 1931TO IT	12AS 2301
10AS 2010B IT	12AS 1935TD																									
10AS 2300BO	12AS 2000B IT																									
10AS 2310B	12AS 2000BO																									
10AS 2310B IT	12AS 2001BO IT																									
10AS 2700BO	12AS 2130TD																									
12AS 1601BO IT	12AS 2130TO																									
12AS 1630TD	12AS 2131TD IT																									
12AS 1631TD IT	12AS 2131TO IT																									
12AS 1930TD	12AS 2140TD																									
12AS 1930TO	12AS 2300B IT																									
12AS 1931TD IT	12AS 2300BO																									
12AS 1931TO IT	12AS 2301																									





<p>T22231</p> 	<p><b>Description:</b> LOW SPEED GEAR (37T.)</p> <p><b>OEM No :</b> 1304 304 543</p> <p><b>EX / CROSS :</b></p>	<p><b>Packaging Unit:</b> 1</p> <p><b>Model:</b> 9S 109 9S 1110TD 9S 1110TO 9S 1111TD IT 9S 1111TO IT 9S 1115TD 9S 1115TO 9S 1310TO 9S 1310TO KMZ 9S 1311TO IT 9S 1315TO</p>
<p>T14279</p> 	<p><b>Description:</b> LOW SPEED GEAR (41-22T.)</p> <p><b>OEM No :</b> 1292 304 018</p> <p><b>EX / CROSS :</b></p>	<p><b>Packaging Unit:</b> 1</p> <p><b>Model:</b></p>
<p>T14776</p> 	<p><b>Description:</b> LOW SPEED GEAR (44-22T.)</p> <p><b>OEM No :</b> 1283 304 007</p> <p><b>EX / CROSS :</b></p>	<p><b>Packaging Unit:</b> 1</p> <p><b>Model:</b></p>
<p>T14808</p> 	<p><b>Description:</b> LOW SPEED GEAR (44-22T.)</p> <p><b>OEM No :</b> 1272 304 133</p> <p><b>EX / CROSS :</b></p>	<p><b>Packaging Unit:</b> 1</p> <p><b>Model:</b></p>
<p>T14806</p> 	<p><b>Description:</b> LOW SPEED GEAR (51-22T.)</p> <p><b>OEM No :</b> 1269 304 072</p> <p><b>EX / CROSS :</b></p>	<p><b>Packaging Unit:</b> 1</p> <p><b>Model:</b></p>



**T08465**



**Description:**  
MAIN SHAFT

**Packaging Unit:** 1

**OEM No :**  
1272 304 058

**Model:**

**EX / CROSS :**

**T63682**



**Description:**  
MAIN SHAFT

**Packaging Unit:** 1

**OEM No :**  
1310 304 189

**Model:**

**EX / CROSS :**

6S 1350 BO  
6S 1600BD  
6S 1601BD IT  
6S 1700BO  
6S 1701BO IT  
6S 1900BO  
6S 1901BO IT

**T52771**



**Description:**  
MAIN SHAFT

**Packaging Unit:** 1

**OEM No :**  
0091 304 266

**Model:**

**EX / CROSS :**  
0091 304 208

16S 1650

**T09511**



**Description:**  
MAIN SHAFT

**Packaging Unit:** 1

**OEM No :**  
1307 304 352

**Model:**

**EX / CROSS :**  
1307 304 054

**T57725**



**Description:**  
MAIN SHAFT

**Packaging Unit:** 1

**OEM No :**  
1354 304 015

**Model:**

**EX / CROSS :**

12S 2131TD IT  
12S 2133TD



**T57717**



**Description:**  
MAIN SHAFT

**Packaging Unit:**

**OEM No :**  
1354 304 014

**Model:**  
12S 2130TD

**EX / CROSS :**

**T59035**



**Description:**  
MAIN SHAFT

**Packaging Unit:** 1

**OEM No :**  
1304 304 604

**Model:**  
8S 180  
8S 2100  
8S 2100BD  
8S 2100BO  
8S 2101BD IT  
8S 2101BO IT

**EX / CROSS :**

**T17839**



**Description:**  
MAIN SHAFT

**Packaging Unit:** 1

**OEM No :**  
1356 304 035

**Model:**

**EX / CROSS :**  
1316 304 132  
1316 304 079

16S 1685  
16S 181  
16S 181 IVE  
16S 181 MAN  
16S 181 RV1  
16S 181IT DAF  
16S 1920TD  
16S 1921TD IT  
16S 1922TD  
16S 1925TD  
16S 1930TD  
16S 1931TD IT  
16S 1935TD  
16S 193TD IT  
16S 221  
16S 221 DAF  
16S 221 MAN  
16S 221 VW  
16S 221IT RV1  
16S 2220TD  
16S 2220TO  
16S 2220TO IT  
16S 2220TO IVE  
16S 2221TD IT

**T17608**



**Description:**  
MAIN SHAFT

**Packaging Unit:** 1

**OEM No :**  
1315 304 131

**Model:**

**EX / CROSS :**  
1315 304 084

16S 151  
16S 151 DAF  
16S 151 HIN  
16S 151 HYU  
16S 151 IVE  
16S 151 KMZ  
16S 151 MAN  
16S 151 RV1  
16S 151PTO HIN  
16S 1620TD  
16S 1621TD IT  
16S 1625TD  
16S 162TD IT  
16S 1630TD  
16S 1631TD IT  
16S 1635TD  
16S 163TD IT  
16S 1820TO  
16S 1820TO KMZ  
16S 1820TO RV1  
16S 1821TO IT  
16S 1822TO  
16S 1825TO  
16S 182TO IT

**T46525**



**Description:**  
MAIN SHAFT

**Packaging Unit:** 1

**OEM No :**  
1346 304 107

**Model:**

**EX / CROSS :**

6AS 1000TO  
6AS 1005TO  
6AS 1010 BO  
6AS 1110BO  
6S 1000TO  
6S 1000TO KMZ  
6S 1005TO  
6S 1010BO  
AS Tronic



**T77058**



**Description:**  
MAIN SHAFT

**Packaging Unit:** 1

**OEM No :**  
1327 304 032

**Model:**  
12AS 2302

**EX / CROSS :**  
1327 304 025

**T57421**



**Description:**  
MAIN SHAFT

**Packaging Unit:** 1

**OEM No :**  
1328 304 063

**Model:**  
16AS 2230TD  
16AS 2231TD IT  
16AS 2600TO  
16AS 2601TO IT  
16AS 2630TO  
16AS 2631TO IT  
16AS 2635TO  
AS Tronic

**EX / CROSS :**

**T50369**



**Description:**  
MAIN SHAFT

**Packaging Unit:** 1

**OEM No :**  
1292 304 070

**Model:**  
5S 111GPA

**EX / CROSS :**  
1292 304 053

**T18726**



**Description:**  
MAIN SHAFT

**Packaging Unit:** 1

**OEM No :**  
1238 304 345

**Model:**

**EX / CROSS :**  
1238 304 007

**T70484**



**Description:**  
MAIN SHAFT

**Packaging Unit:** 1

**OEM No :**  
1316 304 118

**Model:**  
16S 182  
16S 1920TD  
16S 1923TD  
16S 1925TD  
16S 1930TD  
16S 1931TD IT  
16S 1933TD  
16S 193TD IT  
16S 2223TD  
16S 2223TO  
16S 2225TD  
16S 2231TD IT  
16S 2231TO IT  
16S 2233TD  
16S 2233TO  
16S 223TD IT  
16S 223TO IT  
16S 2321TD IT  
16S 2322TD  
16S 2323TD  
16S 2325TD  
16S 232TD IT  
16S 2331TD IT  
16S 2333TD

**EX / CROSS :**

**T81230**



**Description:**  
MAIN SHAFT

**Packaging Unit:** 1

**OEM No :**  
1269 304 060

**Model:**

**EX / CROSS :**

**T85132**



**Description:**  
MAIN SHAFT

**Packaging Unit:** 1

**OEM No :**  
1304 304 630

**Model:**  
16S 109  
8S 109

**EX / CROSS :**

**T37974**



**Description:**  
MAIN SHAFT (22-31-38-36-28T.)

**Packaging Unit:** 1

**OEM No :**  
1311 304 248

**Model:**

**EX / CROSS :**  
1311 304 225

6S 1000BD  
6S 1000BO  
6S 1200BD  
6S 1200BO  
6S 1200BO IKA  
6S 1200BO KMZ  
6S 1200TD  
6S 1200TO  
6S 1205TD  
S6 66  
S6 66+GV66  
S6 85  
S6 85 LIAZ  
S6 85 MAN  
S6 85 MAZ  
S6 85 NEFAZ

**T20714**



**Description:**  
MAIN SHAFT (26-32-31-24T.)

**Packaging Unit:** 1

**OEM No :**  
1324 304 005

**Model:**

**EX / CROSS :**

9S 1110TD  
9S 1110TO  
9S 1111TD IT  
9S 1111TO IT  
9S 1115TD  
9S 1115TO  
9S 1310TO  
9S 1310TO KMZ  
9S 1311TO IT  
9S 1315TO

**T08850**



**Description:**  
MAIN SHAFT (28-38-38-24T.)

**Packaging Unit:** 1

**OEM No :**  
1269 304 061

**Model:**

**EX / CROSS :**

**T14218**



**Description:**

MAIN SHAFT (28-38-38-24T.)

**Packaging Unit:** 1

**OEM No :**

1292 304 035

**Model:**

**EX / CROSS :**

**T08889**



**Description:**

MAIN SHAFT (28-38-38-24T.)

**Packaging Unit:** 1

**OEM No :**

1292 304 069

**Model:**

**EX / CROSS :**

**T09049**



**Description:**

MAIN SHAFT (34-34-41-36-24T.)

**Packaging Unit:** 1

**OEM No :**

1268 304 274

**Model:**

AK6 90  
S6 90  
S6 90 SETRA  
S6 90+GV90  
S6 90/1  
S6 90/1+GV90

**EX / CROSS :**

**T08277**



**Description:**

MAIN SHAFT (34-35-41-36-22T.)

**Packaging Unit:** 1

**OEM No :**

1250 304 388

**Model:**

**EX / CROSS :**

**T19135**



**Description:**

MAIN SHAFT (38-38-31-28T.)

**Packaging Unit:** 1

**OEM No :**

1296 304 119

**Model:**

16S 112  
16S 112/1

**EX / CROSS :**



T09763



**Description:**

MAIN SHAFT (38-38-31-28T.)

**Packaging Unit:** 1

**OEM No :**

1295 304 245

**Model:**

**EX / CROSS :**

T18353



**Description:**

MAIN SHAFT (38-38-34-28T.)

**Packaging Unit:** 1

**OEM No :**

1297 304 181

**Model:**

**EX / CROSS :**

1297 304 030

T19074



**Description:**

MAIN SHAFT (38-40-34-28T.)

**Packaging Unit:** 1

**OEM No :**

1297 304 179

**Model:**

16K 160  
16K 190

**EX / CROSS :**

T17825



**Description:**

MAIN SHAFT (38-44-41-24T.)

**Packaging Unit:** 1

**OEM No :**

1316 304 130

**Model:**

**EX / CROSS :**

1312 304 153

1312 304 134

T17834



**Description:**

MAIN SHAFT (38-44-41-24T.)

**Packaging Unit:** 1

**OEM No :**

1315 304 130

**Model:**

16S 150  
16S 151  
16S 151 DAF  
16S 151 SNVI  
16S 151IT DAF  
8S 151  
Ecosplit III

**EX / CROSS :**

1313 304 072



**T18269**

**Description:**

MAIN SHAFT (38-44-41-25T.)

**Packaging Unit:** 1

**OEM No :**

1315 304 029

**Model:**

16S 151  
Ecosplit III

**EX / CROSS :**



**T22193**

**Description:**

MAIN SHAFT (39-62-36-31-28T.)

**Packaging Unit:** 1

**OEM No :**

1290 304 620

**Model:**

6S 700BO  
6S 700BO KAVZ  
6S 850  
6S 890

**EX / CROSS :**



**T23677**

**Description:**

MAIN SHAFT (39-62-62-29T.)

**Packaging Unit:** 1

**OEM No :**

1307 304 623

**Model:**

5S 600BO  
S5 42  
S5 42 KAVZ  
S5 42 KMZ  
S5 42 MAZ  
S5 42 SNVI  
S5 47

**EX / CROSS :**

1317 304 066



**T08487**

**Description:**

MAIN SHAFT (8-35-41-36-22T.)

**Packaging Unit:** 1

**OEM No :**

1250 304 474

**Model:**

**EX / CROSS :**



**T08574**

**Description:**

MAIN SHAFT (8-35-41-36-22T.)

**Packaging Unit:** 1





**OEM No :**





1250 304 129

**Model:**

**EX / CROSS :**







<p><b>T57353</b></p> 	<p><b>Description:</b> NEEDLE BEARING</p> <p><b>Packaging Unit:</b> 1</p> <p><b>OEM No :</b> 0735 321 487</p> <p><b>EX / CROSS :</b> 0735 301 274</p> <p><b>Model:</b> 10AS 2010B IT 10AS 2300BO 10AS 2310B 10AS 2310B IT 10AS 2700BO 12 TX 1410 TD IT (1372 001 023) 12 TX 1410 TD IT (1372 001 030) 12 TX 1410 TO (1372 002 019) 12 TX 1411 TD IT (1372 040 027) 12 TX 1411 TD IT (1372 040 251)</p> <p>12 TX 1415 TD IT (1372 001 026) 12 TX 1610 TO IT (1372 002 025) 12 TX 1610 TO IT (1372 002 045) 12 TX 1611 BO IT (1372 044 006) 12 TX 1611 BO IT (1372 044 033) 12 TX 1611 BO IT (1372 044 050) 12 TX 1611 BO IT (1372 044 251)</p>
<p><b>T57377</b></p> 	<p><b>Description:</b> NEEDLE BEARING</p> <p><b>Packaging Unit:</b> 1</p> <p><b>OEM No :</b> 0735 301 881</p> <p><b>EX / CROSS :</b> 0735 321 381</p> <p><b>Model:</b> 10AS 2010B IT 10AS 2300BO 10AS 2310B 10AS 2310B IT 10AS 2700BO 12AS 1601BO IT 12AS 1630TD 12AS 1631TD IT 12AS 1930TD 12AS 1930TO 12AS 1931TD IT 12AS 1931TO IT</p> <p>12AS 1935TD 12AS 2000B IT 12AS 2000BO 12AS 2001BO IT 12AS 2130TD 12AS 2130TO 12AS 2131TD IT 12AS 2131TO IT 12AS 2140TD 12AS 2300B IT 12AS 2300BO 12AS 2301</p>
<p><b>T59143</b></p> 	<p><b>Description:</b> NEEDLE BEARING</p> <p><b>Packaging Unit:</b> 1</p> <p><b>OEM No :</b> 0750 115 233</p> <p><b>EX / CROSS :</b> 0735 320 941</p> <p><b>Model:</b> 5S 580 5S 600BO 6AS 300VD 6AS 320VD 6AS 380VO 6S 1000BD 6S 1000BO 6S 1200BD 6S 1200BO 6S 1200TD 6S 1200TO 6S 1205TD</p> <p>6S 1350 BO 6S 1600 6S 1600BD 6S 1601BD IT 6S 1700BO 6S 1701BO IT 6S 1900BO 6S 1901BO IT 6S 300 AS Tronic S5 42 S5 420</p>
<p><b>T50164</b></p> 	<p><b>Description:</b> NEEDLE BEARING (104,5X128,4X10) INA ORIGINAL</p> <p><b>Packaging Unit:</b> 1</p> <p><b>OEM No :</b> 0735 298 169</p> <p><b>EX / CROSS :</b></p> <p><b>Model:</b> 12S 2130TD 12S 2131TD IT 12S 2133TD 12S 2330TD 12S 2331TD IT 12S 2333TD 12S 233TD IT 12S 2830TD 12S 2831TD IT 12S 2833TD 12S 283TD IT 16S 151</p> <p>16S 1620TD 16S 1621TD IT 16S 1625TD 16S 162TD IT 16S 1630TD 16S 1631TD IT 16S 1635TD 16S 163TD IT 16S 1685 16S 181 16S 182 16S 1820TO</p>
<p><b>T72948</b></p> 	<p><b>Description:</b> NEEDLE BEARING (10X14X15)</p> <p><b>Packaging Unit:</b> 5</p> <p><b>OEM No :</b> 0635 303 019</p> <p><b>EX / CROSS :</b></p> <p><b>Model:</b> 16S 1685</p>

<p><b>T56554</b></p> 	<p><b>Description:</b> NEEDLE BEARING (30X50X29,8)</p> <p><b>OEM No :</b> 0735 358 346</p> <p><b>EX / CROSS :</b> 0735 358 333 0735 358 340</p> <p><b>Model:</b> 6AS 1000TO 6AS 1005TO 6AS 800TO 6AS 805TO 6S 1000TO 6S 1005TO 6S 1010BO 6S 800TO AS Tronic</p>	<p><b>Packaging Unit:</b> 1</p>
<p><b>T63588</b></p> 	<p><b>Description:</b> NEEDLE BEARING (31X46X27,2)</p> <p><b>OEM No :</b> 0735 358 128</p> <p><b>EX / CROSS :</b> 0735 358 156 0750 115 135</p> <p><b>Model:</b> 6AS 700TO 6S 700BO 6S 850 6S 890 AS Tronic S5 680 S6 36 S6 36+GV36 S6 36/2</p>	<p><b>Packaging Unit:</b> 1</p>
<p><b>T51495</b></p> 	<p><b>Description:</b> NEEDLE BEARING (40X60X26)</p> <p><b>OEM No :</b> 0735 358 192</p> <p><b>EX / CROSS :</b> 0750 115 229 0750 115 974</p> <p><b>Model:</b> 12AS 1210TO 12AS 1220TD 12AS 1420TD 12AS 1420TO 12AS 1620TO 16S 109 6S 150C 8S 109 8S 140 8S 180 8S 2100BD 8S 2100BO</p>	<p><b>Packaging Unit:</b> 2</p> <p>8S 2101BD IT 8S 2101BO IT 9S 109 9S 1110TD 9S 1110TO 9S 1111TD IT 9S 1111TO IT 9S 1115TD 9S 1115TO 9S 1310TO 9S 1311TO IT 9S 1315TO</p>
<p><b>T53937</b></p> 	<p><b>Description:</b> NEEDLE BEARING (43X48X39,5)</p> <p><b>OEM No :</b> 0735 321 010</p> <p><b>EX / CROSS :</b></p> <p><b>Model:</b> 5S 580 5S 600BO S5 42 S5 420 S5 47</p>	<p><b>Packaging Unit:</b> 1</p>
<p><b>T46897</b></p> 	<p><b>Description:</b> NEEDLE BEARING (45X53X21)</p> <p><b>OEM No :</b> 0750 115 011</p> <p><b>EX / CROSS :</b> K 45X53X21 A 0735 320 042 0735 320 492</p> <p><b>Model:</b> 16K 130 16K 160 16K 190 16S 112 16S 112/1 16S 130 16S 130/1 16S 150 16S 160 16S 160/1 16S 160A 16S 160A/1</p>	<p><b>Packaging Unit:</b> 1</p> <p>16S 1650 16S 190 16S 190/1 16S 190A 16S 190A/1 16S 200 4S 120GP 4S 150GP 4S 150GP+400 5K 110GP 5K 110GP+GV90 5K 110GPA</p>



<p><b>T49209</b></p> 	<p><b>Description:</b> NEEDLE BEARING (45X57X21)</p> <p><b>OEM No :</b> 0750 115 366</p> <p><b>EX / CROSS :</b> F-217112</p>	<p><b>Packaging Unit:</b> 1</p> <p><b>Model:</b></p> <ul style="list-style-type: none"> <li>12S 2130TD</li> <li>12S 2131TD IT</li> <li>12S 2133TD</li> <li>16S 151</li> <li>16S 151 DAF</li> <li>16S 151 HIN</li> <li>16S 151 HYU</li> <li>16S 151 IVE</li> <li>16S 151 KMZ</li> <li>16S 151 MAN</li> <li>16S 151 RVI</li> <li>16S 151 SNVI</li> <li>16S 151IT DAF</li> <li>16S 151PTO HIN</li> <li>16S 1620TD</li> <li>16S 1621TD IT</li> <li>16S 1625TD</li> <li>16S 162TD IT</li> <li>16S 1630TD</li> <li>16S 1631TD IT</li> <li>16S 1635TD</li> <li>16S 163TD IT</li> <li>16S 1820TO</li> <li>16S 1820TO KMZ</li> </ul>
<p><b>T50167</b></p> 	<p><b>Description:</b> NEEDLE BEARING (45X57X25)</p> <p><b>OEM No :</b> 0750 115 369</p> <p><b>EX / CROSS :</b></p>	<p><b>Packaging Unit:</b> 1</p> <p><b>Model:</b></p> <ul style="list-style-type: none"> <li>12S 2330TD</li> <li>12S 2331TD IT</li> <li>12S 2333TD</li> <li>12S 233TD IT</li> <li>12S 2830TD</li> <li>12S 2831TD IT</li> <li>12S 2833TD</li> <li>12S 283TD IT</li> <li>16S 1685</li> <li>16S 181</li> <li>16S 182</li> <li>16S 1920TD</li> <li>16S 1921TD IT</li> <li>16S 1922TD</li> <li>16S 1923TD</li> <li>16S 1925TD</li> <li>16S 1930TD</li> <li>16S 1931TD IT</li> <li>16S 1933TD</li> <li>16S 1935TD</li> <li>16S 193TD IT</li> <li>16S 221</li> <li>16S 2220TD</li> <li>16S 2220TO</li> </ul>
<p><b>T78305</b></p> 	<p><b>Description:</b> NEEDLE BEARING (50X56X53,8)</p> <p><b>OEM No :</b> 0750 115 565</p> <p><b>EX / CROSS :</b> 0735 321 580 0735 321 588</p>	<p><b>Packaging Unit:</b> 1</p> <p><b>Model:</b></p> <ul style="list-style-type: none"> <li>6AS 1000TO</li> <li>6AS 1005TO</li> <li>6AS 1010 BO</li> <li>6AS 1110BO</li> <li>6S 1000TO</li> <li>6S 1005TO</li> <li>6S 1010BO</li> <li>AS Tronic</li> </ul>
<p><b>T46888</b></p> 	<p><b>Description:</b> NEEDLE BEARING (57X63X43)</p> <p><b>OEM No :</b> 0735 320 314</p> <p><b>EX / CROSS :</b> F-50908 0735 320 203 9999 888 662</p>	<p><b>Packaging Unit:</b> 1</p> <p><b>Model:</b></p> <ul style="list-style-type: none"> <li>AK6 80</li> <li>AK6 80+GV80</li> <li>AK6 90</li> <li>AK6 90+GV90</li> <li>S6 80+GV80</li> <li>S6 90</li> <li>S6 90+GV90</li> <li>S6 90/1</li> <li>S6 90/1+GV90</li> </ul>
<p><b>T50166</b></p> 	<p><b>Description:</b> NEEDLE BEARING (59,5X81,5X22)</p> <p><b>OEM No :</b> 0750 115 299</p> <p><b>EX / CROSS :</b></p>	<p><b>Packaging Unit:</b> 1</p> <p><b>Model:</b></p> <ul style="list-style-type: none"> <li>16S 109</li> <li>8S 109</li> </ul>



<p><b>T53922</b></p> 	<p><b>Description:</b> NEEDLE BEARING (60X66X42)</p> <p><b>OEM No :</b> 0735 320 871</p> <p><b>EX / CROSS :</b></p>	<p><b>Packaging Unit:</b> 1</p> <p><b>Model:</b> 5S 580 5S 600BO S5 42 S5 420 S5 47</p>
<p><b>T50169</b></p> 	<p><b>Description:</b> NEEDLE BEARING (60X68X25)</p> <p><b>OEM No :</b> 0750 115 969</p> <p><b>EX / CROSS :</b> 0735 321 563 0735 302 221</p>	<p><b>Packaging Unit:</b> 1</p> <p><b>Model:</b> 9S 1110TD 9S 1110TO 9S 1111TD IT 9S 1111TO IT 9S 1115TD 9S 1115TO 9S 1310TO 9S 1311TO IT 9S 1315TO</p>
<p><b>T51522</b></p> 	<p><b>Description:</b> NEEDLE BEARING (60X68X39)</p> <p><b>OEM No :</b> 0750 115 973</p> <p><b>EX / CROSS :</b> 0750 115 225</p>	<p><b>Packaging Unit:</b> 1</p> <p><b>Model:</b> 16S 109 6S 150C 8S 109 8S 140 8S 180 8S 2100BD 8S 2100BO 8S 2101BD IT 8S 2101BO IT 9S 109 9S 1110TD 9S 1110TO 9S 1111TD IT 9S 1111TO IT 9S 1115TD 9S 1115TO 9S 1310TO 9S 1311TO IT 9S 1315TO</p>
<p><b>T46856</b></p> 	<p><b>Description:</b> NEEDLE BEARING (62X70X37)</p> <p><b>OEM No :</b> 0735 320 396</p> <p><b>EX / CROSS :</b> F-58723 0735 320 261</p>	<p><b>Packaging Unit:</b> 1</p> <p><b>Model:</b> 5K 110GP 5K 110GP+GV90 5K 110GPA 5K 110GPA+GV90 5S 110GP 5S 110GP+GV90 5S 110GPA 5S 110GPA+GV90</p>
<p><b>T46801</b></p> 	<p><b>Description:</b> NEEDLE BEARING (62X70X40)</p> <p><b>OEM No :</b> 0735 320 499</p> <p><b>EX / CROSS :</b> K 62X70X40 ZW 0735 320 161 0735 320 205 0750 115 007</p>	<p><b>Packaging Unit:</b> 1</p> <p><b>Model:</b> 5S 110GP 5S 111GP 5S 111GP+GV90 5S 111GPA AK6 90 S6 36 S6 36+GV36 S6 36/2 S6 90 S6 90+GV90 S6 90/1 S6 90/1+GV90</p>



T54656



**Description:**

NEEDLE BEARING (66X74X22,5)

**Packaging Unit:** 1

**OEM No :**

0735 320 837

**Model:**

S5 680  
S5 680 SSO  
S6 1550

**EX / CROSS :**

T53929



**Description:**

NEEDLE BEARING (67X73X37)

**Packaging Unit:** 1

**OEM No :**

0735 320 873

**Model:**

5S 580  
5S 600BO  
S5 42  
S5 420  
S5 47

**EX / CROSS :**

T64098



**Description:**

NEEDLE BEARING (67X75X37)

**Packaging Unit:** 1

**OEM No :**

0750 115 427

**Model:**

9S 75  
S5 42

**EX / CROSS :**

0735 321 013

T46785



**Description:**

NEEDLE BEARING (70X78X43)

**Packaging Unit:** 1

**OEM No :**

0735 320 465

**Model:**

5S 110GP  
5S 111GP  
5S 111GP+GV90  
5S 111GPA

**EX / CROSS :**

722013010

F-58637

0735 300 149

T46670



**Description:**

NEEDLE BEARING (70X78X46)

**Packaging Unit:** 1

**OEM No :**

0735 320 548



**Model:**

16S 112  
16S 112/1  
16S 130  
16S 130/1

**EX / CROSS :**

<p><b>T46759</b></p> 	<p><b>Description:</b> NEEDLE BEARING (70X78X55)</p> <p><b>OEM No :</b> 0735 320 496</p> <p><b>EX / CROSS :</b></p>	<p><b>Packaging Unit:</b> 1</p> <p><b>Model:</b> 16S 130 16S 130/1</p>
<p><b>T77648</b></p> 	<p><b>Description:</b> NEEDLE BEARING (70X78X60)</p> <p><b>OEM No :</b> 0750 115 430</p> <p><b>EX / CROSS :</b> 0735 321 169</p>	<p><b>Packaging Unit:</b> 1</p> <p><b>Model:</b> 8S 180 8S 2100 8S 2100BD 8S 2100BO 8S 2101BD IT 8S 2101BO IT</p>
<p><b>T78313</b></p> 	<p><b>Description:</b> NEEDLE BEARING (72X80X35,8)</p> <p><b>OEM No :</b> 0750 115 566</p> <p><b>EX / CROSS :</b> 0735 321 581 0735 321 589</p>	<p><b>Packaging Unit:</b> 1</p> <p><b>Model:</b> 6AS 1000TO 6AS 1005TO 6AS 1010 BO 6AS 1110BO 6S 1000TO 6S 1005TO 6S 1010BO AS Tronic</p>
<p><b>T50165</b></p> 	<p><b>Description:</b> NEEDLE BEARING (75X83X23)</p> <p><b>OEM No :</b> 0735 320 816</p> <p><b>EX / CROSS :</b> 0750 115 971</p>	<p><b>Packaging Unit:</b> 1</p> <p><b>Model:</b> 16S 109 6S 150C 8S 109 8S 140 9S 109 9S 1110TD 9S 1110TO 9S 1111TD IT 9S 1111TO IT 9S 1115TD 9S 1115TO 9S 1310TO</p> <p>9S 1311TO IT 9S 1315TO</p>
<p><b>T46816</b></p> 	<p><b>Description:</b> NEEDLE BEARING (75X83X33)</p> <p><b>OEM No :</b> 0735 320 377</p> <p><b>EX / CROSS :</b> F-59437</p>	<p><b>Packaging Unit:</b> 1</p> <p><b>Model:</b> 5K 90GP 5K 90GPA 5K 91GP 5K 91GPA 5S 90GP 5S 90GPA 5S 92GP S4 90 S5 50</p>



<p><b>T51474</b></p> 	<p><b>Description:</b> NEEDLE BEARING (75X83X35)</p> <p><b>OEM No :</b> 0735 321 530</p> <p><b>EX / CROSS :</b> F-233439 0735 320 500 0750 115 009 0750 115 012</p>	<p><b>Packaging Unit:</b> 1</p> <p><b>Model:</b></p>
<p><b>T46834</b></p> 	<p><b>Description:</b> NEEDLE BEARING (75X83X40)</p> <p><b>OEM No :</b> 0750 115 970</p> <p><b>EX / CROSS :</b> F-87588 0735 320 462 0735 320 551 0735 320 374</p>	<p><b>Packaging Unit:</b> 1</p> <p><b>Model:</b> 4S 120GP 5K 90GP 5K 90GPA 5K 91GP 5K 91GPA 5S 90GP 5S 90GPA 5S 92GP AK6 65 AK6 65+GV80 S5 50 S6 65</p> <p>S6 65+GV80</p>
<p><b>T46721</b></p> 	<p><b>Description:</b> NEEDLE BEARING (78X86X44)</p> <p><b>OEM No :</b> 0735 320 486</p> <p><b>EX / CROSS :</b> F-88404 0750 115 957</p>	<p><b>Packaging Unit:</b> 1</p> <p><b>Model:</b> 16K 160 16K 190 16S 160 16S 160/1 16S 160A 16S 160A/1 16S 1650 16S 190 16S 190/1 16S 190A 16S 190A/1 16S 200</p> <p>8S 190</p>
<p><b>T46794</b></p> 	<p><b>Description:</b> NEEDLE BEARING (80X88X35)</p> <p><b>OEM No :</b> 0735 320 466</p> <p><b>EX / CROSS :</b> F-88416 0735 300 150</p>	<p><b>Packaging Unit:</b> 1</p> <p><b>Model:</b> 5S 110GP 5S 111GP 5S 111GP+GV90 5S 111GPA</p>
<p><b>T46911</b></p> 	<p><b>Description:</b> NEEDLE BEARING (80X88X40)</p> <p><b>OEM No :</b> 0735 320 407</p> <p><b>EX / CROSS :</b> 0735 320 110</p>	<p><b>Packaging Unit:</b> 1</p> <p><b>Model:</b> AK6 80 AK6 80+GV80 AK6 90 AK6 90+GV90 S6 80/1 S6 80/1+GV80 S6 90 S6 90+GV90 S6 90/1 S6 90/1+GV90</p>







<p><b>T78320</b></p> 	<p><b>Description:</b> NEEDLE BEARING (80X88X41,8)</p> <p><b>OEM No :</b> 0750 115 567</p> <p><b>EX / CROSS :</b> 0735 321 582 0735 321 590</p>	<p><b>Packaging Unit:</b> 1</p> <p><b>Model:</b> 6AS 100TO 6AS 1005TO 6AS 1010 BO 6AS 1110BO 6AS 800TO 6AS 805TO 6S 1000TO 6S 1005TO 6S 1010BO 6S 800TO AS Tronic</p>
<p><b>T46931</b></p> 	<p><b>Description:</b> NEEDLE BEARING (80X88X46)</p> <p><b>OEM No :</b> 0750 115 283</p> <p><b>EX / CROSS :</b> K 80X88X46 ZW A 0735 320 471 0735 320 410 0735 320 206</p>	<p><b>Packaging Unit:</b> 1</p> <p><b>Model:</b> 4S 150GP 4S 150GP+400 AK6 80 AK6 80+GV80 AK6 90 AK6 90+GV90 S6 1550 S6 80 S6 80+GV80 S6 80/1 S6 80/1+GV80 S6 90 S6 90+GV90 S6 90/1 S6 90/1+GV90</p>
<p><b>T46847</b></p> 	<p><b>Description:</b> NEEDLE BEARING (82X90X37)</p> <p><b>OEM No :</b> 0735 320 371</p> <p><b>EX / CROSS :</b> F-58242 0735 320 483 0735 320 484</p>	<p><b>Packaging Unit:</b> 1</p> <p><b>Model:</b> 5K 110GP 5K 110GP+GV90 5K 110GPA 5K 110GPA+GV90 5S 110GP 5S 110GP+GV90 5S 110GPA 5S 110GPA+GV90</p>
<p><b>T46676</b></p> 	<p><b>Description:</b> NEEDLE BEARING (82X90X42)</p> <p><b>OEM No :</b> 0735 320 549</p> <p><b>EX / CROSS :</b></p>	<p><b>Packaging Unit:</b> 1</p> <p><b>Model:</b> 16S 112 16S 112/1</p>
<p><b>T46664</b></p> 	<p><b>Description:</b> NEEDLE BEARING (82X90X46)</p> <p><b>OEM No :</b> 0735 320 460</p> <p><b>EX / CROSS :</b></p>	<p><b>Packaging Unit:</b> 1</p> <p><b>Model:</b> 16K 130 16S 112 16S 112/1</p>















<p><b>T46712</b></p> 	<p><b>Description:</b> NEEDLE BEARING (82X90X55)</p> <p><b>OEM No :</b> 0735 320 452</p> <p><b>EX / CROSS :</b> F-553954 F-84992 0750 115 021 0750 115 958</p>	<p><b>Packaging Unit:</b> 1</p> <p><b>Model:</b> 16S 160 16S 160/1 16S 160A 16S 160A/1 16S 1650 16S 190 16S 190/1 16S 190A 16S 190A/1 16S 200 8S 190</p>
<p><b>T46704</b></p> 	<p><b>Description:</b> NEEDLE BEARING (82X90X60)</p> <p><b>OEM No :</b> 0735 320 451</p> <p><b>EX / CROSS :</b> F-553952 F-87934</p>	<p><b>Packaging Unit:</b> 1</p> <p><b>Model:</b> 16S 130 16S 130/1 16S 160 16S 160/1 16S 160A 16S 160A/1 16S 190 16S 190/1 16S 190A 16S 190A/1 16S 200 16S 220 8S 190</p>
<p><b>T46731</b></p> 	<p><b>Description:</b> NEEDLE BEARING (82X90X68)</p> <p><b>OEM No :</b> 0735 320 487</p> <p><b>EX / CROSS :</b> F-88405 0750 115 956</p>	<p><b>Packaging Unit:</b> 1</p> <p><b>Model:</b> 16S 160 16S 160/1 16S 160A 16S 160A/1 16S 1650 16S 190 16S 190/1 16S 190A 16S 190A/1 16S 200 8S 190</p>
<p><b>T46878</b></p> 	<p><b>Description:</b> NEEDLE BEARING (84X96X36,5)</p> <p><b>OEM No :</b> 0735 320 154</p> <p><b>EX / CROSS :</b> F-20339</p>	<p><b>Packaging Unit:</b> 1</p> <p><b>Model:</b> AK6 80 AK6 80+GV80 AK6 90 AK6 90+GV90 S6 1550 S6 80 S6 80+GV80 S6 80/1 S6 80/1+GV80 S6 90 S6 90+GV90 S6 90/1</p> <p>S6 90/1+GV90</p>
<p><b>T46683</b></p> 	<p><b>Description:</b> NEEDLE BEARING (88X96X23)</p> <p><b>OEM No :</b> 0735 320 799</p> <p><b>EX / CROSS :</b> 0735 320 475 0735 320 684</p>	<p><b>Packaging Unit:</b> 1</p> <p><b>Model:</b> 16S 112 16S 112/1</p>

<p><b>T46769</b></p> 	<p><b>Description:</b> NEEDLE BEARING (88X96X24,5)</p> <p><b>OEM No :</b> 0735 320 786</p> <p><b>EX / CROSS :</b> 0735 320 584 0501 398 351</p>	<p><b>Packaging Unit:</b> 1</p> <p><b>Model:</b> 16K 130 16S 130 16S 130/1</p>
<p><b>T46739</b></p> 	<p><b>Description:</b> NEEDLE BEARING (88X96X29)</p> <p><b>OEM No :</b> 0735 320 896</p> <p><b>EX / CROSS :</b> 0750 115 959</p>	<p><b>Packaging Unit:</b> 1</p> <p><b>Model:</b> 16K 160 16K 190 16S 160 16S 160/1 16S 160A 16S 160A/1 16S 1650 16S 190 16S 190/1 16S 190A 16S 190A/1 16S 200</p> <p>8S 190</p>
<p><b>T56157</b></p> 	<p><b>Description:</b> NEEDLE BEARING (90X98X50)</p> <p><b>OEM No :</b> 0750 115 326</p> <p><b>EX / CROSS :</b></p>	<p><b>Packaging Unit:</b> 1</p> <p><b>Model:</b> 16S 1685 16S 181 16S 182 16S 1920TD 16S 1921TD IT 16S 1922TD 16S 1923TD 16S 1925TD 16S 1930TD 16S 1931TD IT 16S 1933TD 16S 1935TD</p> <p>16S 193TD IT 16S 220 16S 220A 16S 221 16S 2220TD 16S 2220TO 16S 2220TO IT 16S 2221TD IT 16S 2221TO IT 16S 2222TD 16S 2222TO 16S 2223TD</p>
<p><b>T49178</b></p> 	<p><b>Description:</b> NEEDLE BEARING (92X100X53)</p> <p><b>OEM No :</b> 0750 115 584</p> <p><b>EX / CROSS :</b> 0735 321 087</p>	<p><b>Packaging Unit:</b> 1</p> <p><b>Model:</b> 16S 150 16S 151 16S 151 DAF 16S 151 HIN 16S 151 HYU 16S 151 IVE 16S 151 KMZ 16S 151 MAN 16S 151 RVI 16S 151 SNVI 16S 151IT DAF 16S 1620TD</p> <p>16S 1621TD IT 16S 1625TD 16S 162TD IT 16S 1820TO 16S 1820TO KMZ 16S 1820TO RVI 16S 1821TO IT 16S 1822TO 16S 1823TO 16S 1825TO 16S 182TO IT 8S 151</p>
<p><b>T56143</b></p> 	<p><b>Description:</b> NEEDLE BEARING (92X100X63)</p> <p><b>OEM No :</b> 0750 115 303</p> <p><b>EX / CROSS :</b> 0735 321 094</p>	<p><b>Packaging Unit:</b> 1</p> <p><b>Model:</b> 16S 1685 16S 181 16S 182 16S 1920TD 16S 1921TD IT 16S 1922TD 16S 1923TD 16S 1925TD 16S 1930TD 16S 1931TD IT 16S 1933TD 16S 1935TD</p> <p>16S 193TD IT 16S 220 16S 220A 16S 221 16S 2220TD 16S 2220TO 16S 2220TO IT 16S 2221TD IT 16S 2221TO IT 16S 2222TD 16S 2222TO 16S 2223TD</p>





<p><b>T61001</b></p> 	<p><b>Description:</b> NEEDLE BEARING (93X101X25)</p> <p><b>OEM No :</b> 0750 115 310</p> <p><b>EX / CROSS :</b> 0735 321 373 0735 321 437</p>	<p><b>Packaging Unit:</b> 1</p> <p><b>Model:</b> 16S 150 16S 151 Ecosplit III</p>
<p><b>T46924</b></p> 	<p><b>Description:</b> NEEDLE BEARING (95X103X40)</p> <p><b>OEM No :</b> 0750 115 282</p> <p><b>EX / CROSS :</b> K 95X103X40 ZW A 0735 320 111 0735 320 408</p>	<p><b>Packaging Unit:</b> 1</p> <p><b>Model:</b> AK6 80 AK6 80+GV80 AK6 90 AK6 90+GV90 S6 80/1 S6 80/1+GV80 S6 90 S6 90+GV90 S6 90/1 S6 90/1+GV90</p>
<p><b>T49199</b></p> 	<p><b>Description:</b> NEEDLE BEARING (96X104X55)</p> <p><b>OEM No :</b> 0750 115 325</p> <p><b>EX / CROSS :</b> F-212875.01</p>	<p><b>Packaging Unit:</b> 1</p> <p><b>Model:</b> 16S 150 16S 151 16S 151 DAF 16S 151 HIN 16S 151 HYU 16S 151 IVE 16S 151 KMZ 16S 151 MAN 16S 151 RVI 16S 151 SNVI 16S 151IT DAF 16S 151PTO HIN 16S 1620TD 16S 1621TD IT 16S 1625TD 16S 162TD IT 16S 1630TD 16S 1631TD IT 16S 1635TD 16S 163TD IT 16S 1820TO 16S 1820TO KMZ 16S 1820TO RVI 16S 1821TO IT</p>
<p><b>T56150</b></p> 	<p><b>Description:</b> NEEDLE BEARING (96X104X72)</p> <p><b>OEM No :</b> 0750 115 327</p> <p><b>EX / CROSS :</b></p>	<p><b>Packaging Unit:</b> 1</p> <p><b>Model:</b> 12S 2130TD 12S 2131TD IT 12S 2133TD 16S 1685 16S 181 16S 182 16S 1920TD 16S 1921TD IT 16S 1922TD 16S 1923TD 16S 1925TD 16S 1930TD 16S 1931TD IT 16S 1933TD 16S 1935TD 16S 193TD IT 16S 220 16S 220A 16S 221 16S 221TD 16S 2220TD 16S 2220TO 16S 2220TO IT 16S 2221TD IT 16S 2221TO IT</p>
<p><b>T46662</b></p> 	<p><b>Description:</b> NEEDLE BEARING KIT</p> <p><b>OEM No :</b> 1295 298 948</p> <p><b>EX / CROSS :</b></p>	<p><b>Packaging Unit:</b> 1</p> <p><b>Model:</b> 16S 112 16S 112/1</p>

<p><b>T46784</b></p> 	<p><b>Description:</b> NEEDLE BEARING KIT</p> <p><b>OEM No :</b> 1292 298 905</p> <p><b>EX / CROSS :</b></p>	<p><b>Packaging Unit:</b> 1</p> <p><b>Model:</b> 5S 110GP 5S 111GP 5S 111GP+GV90 5S 111GPA</p>
<p><b>T46876</b></p> 	<p><b>Description:</b> NEEDLE BEARING KIT</p> <p><b>OEM No :</b> 1268 298 950</p> <p><b>EX / CROSS :</b></p>	<p><b>Packaging Unit:</b> 1</p> <p><b>Model:</b> S6 90 S6 90/1</p>
<p><b>T15760</b></p> 	<p><b>Description:</b> NEEDLE ROLLER (Ø10X16,8)</p> <p><b>OEM No :</b> 0750 119 143</p> <p><b>EX / CROSS :</b> 0750 119 116 0750 119 109 0735 470 163 0735 470 074</p>	<p><b>Packaging Unit:</b> 140</p> <p><b>Model:</b></p>
<p><b>T08935</b></p> 	<p><b>Description:</b> NEEDLE ROLLER (Ø5X13,75)</p> <p><b>OEM No :</b> 0735 470 027</p> <p><b>EX / CROSS :</b></p>	<p><b>Packaging Unit:</b> 200</p> <p><b>Model:</b></p>
<p><b>T08936</b></p> 	<p><b>Description:</b> NEEDLE ROLLER (Ø6X14,8)</p> <p><b>OEM No :</b> 0735 470 057</p> <p><b>EX / CROSS :</b></p>	<p><b>Packaging Unit:</b> 180</p> <p><b>Model:</b></p>







<p><b>T57481</b></p> 	<p><b>Description:</b> NEEDLE ROLLER (Ø7,9X16,6)</p> <p><b>OEM No :</b> 0730 162 804</p> <p><b>EX / CROSS :</b></p>	<p><b>Packaging Unit:</b> 6</p> <p><b>Model:</b> 10AS 2010B IT 10AS 2300BO 10AS 2310B 10AS 2310B IT 10AS 2700BO 12 TX 1410 TD IT (1372 001 023) 12 TX 1410 TD IT (1372 001 030) 12 TX 1410 TO (1372 002 019) 12 TX 1411 TD IT (1372 040 027) 12 TX 1411 TD IT (1372 040 028)</p> <p>12 TX 1415 TD IT (1372 001 026) 12 TX 1610 TO IT (1372 002 025) 12 TX 1610 TO IT (1372 002 045) 12 TX 1611 BO IT (1372 044 006) 12 TX 1611 BO IT (1372 044 033) 12 TX 1611 BO IT (1372 044 050) 12 TX 1611 BO IT (1372 044 051)</p>
<p><b>T23323</b></p> 	<p><b>Description:</b> NUT (M12)</p> <p><b>OEM No :</b> 0737 300 035</p> <p><b>EX / CROSS :</b> 0737 006 005 0737 006 061</p>	<p><b>Packaging Unit:</b> 1</p> <p><b>Model:</b> 16S 151PTO HIN AK6 65 AK6 65+GV80 AK6 80 AK6 80+GV80</p>
<p><b>T21748</b></p> 	<p><b>Description:</b> O-RING</p> <p><b>OEM No :</b> 0750 112 019</p> <p><b>EX / CROSS :</b> 0734 317 150 0734 317 032</p>	<p><b>Packaging Unit:</b> 2</p> <p><b>Model:</b> 16K 130 16K 160 16K 190 16S 112 16S 112/1 16S 130 16S 130/1 16S 1300 16S 150 16S 151 16S 151 MAN 16S 160</p> <p>16S 160/1 16S 1600 16S 160A 16S 160A/1 16S 1650 16S 1650 MAZ 16S 181 16S 190 16S 190/1 16S 1900 16S 190A 16S 200</p>
<p><b>T21955</b></p> 	<p><b>Description:</b> O-RING</p> <p><b>OEM No :</b> 0634 313 375</p> <p><b>EX / CROSS :</b> 0501 317 536</p>	<p><b>Packaging Unit:</b> 5</p> <p><b>Model:</b> 16S 150 16S 151 16S 151 DAF 16S 151 HIN 16S 151 HYU 16S 151 IVE 16S 151 KMZ 16S 151 MAN 16S 151 RVI 16S 151 SNVI 16S 151IT DAF 16S 151PTO HIN</p> <p>16S 1620TD 16S 1621TD IT 16S 1625TD 16S 162TD IT 16S 1685 16S 181 16S 181 IVE 16S 181 MAN 16S 181 RVI 16S 181IT DAF 16S 182 16S 1820TO</p>
<p><b>T37680</b></p> 	<p><b>Description:</b> O-RING (13X2)</p> <p><b>OEM No :</b> 0634 316 523</p> <p><b>EX / CROSS :</b></p>	<p><b>Packaging Unit:</b> 1</p> <p><b>Model:</b></p>





<p><b>T21981</b></p> 	<p><b>Description:</b> O-RING (20X3)</p>	<p><b>Packaging Unit:</b> 1</p>
	<p><b>OEM No :</b> 0634 313 198</p>	<p><b>Model:</b> 16S 181 16S 181 IVE 16S 181 MAN 16S 181 RVI 16S 181IT DAF 16S 1820TO KMZ 16S 1820TO RVI 16S 221 16S 221 DAF 16S 221 IVE 16S 221 MAN 16S 221 MB 16S 1685</p>
	<p><b>EX / CROSS :</b></p>	
<p><b>T21107</b></p> 	<p><b>Description:</b> O-RING (36,2X3)</p>	<p><b>Packaging Unit:</b> 5</p>
	<p><b>OEM No :</b> 0634 316 057</p>	<p><b>Model:</b> 16K 130 16K 160 16K 190 16S 109 16S 112 16S 112/1 16S 130 16S 130/1 16S 150 16S 151 16S 151 MAN 16S 160 16S 160/1 16S 160A 16S 160A/1 16S 181 16S 190 16S 190/1 16S 190A 16S 190A/1 16S 220 16S 220A 16S 221 16S 251</p>
	<p><b>EX / CROSS :</b> 0634 314 021</p>	
<p><b>T22001</b></p> 	<p><b>Description:</b> O-RING (42X3)</p>	<p><b>Packaging Unit:</b> 10</p>
	<p><b>OEM No :</b> 0634 313 505</p>	<p><b>Model:</b> 16S 109 STR 16S 151 16S 151 DAF 16S 151 HIN 16S 151 HYU 16S 151 IVE 16S 151 KMZ 16S 151 MAN 16S 151 RVI 16S 151 SNVI 16S 151IT DAF 16S 151PTO HIN 16S 1685 16S 181 16S 181 IVE 16S 181 MAN 16S 181 RVI 16S 181IT DAF 16S 1820TO KMZ 16S 221 16S 221 DAF 16S 221 IVE 16S 221 MB 16S 221 RVI</p>
	<p><b>EX / CROSS :</b></p>	
<p><b>T21618</b></p> 	<p><b>Description:</b> O-RING (5,28X1,78)</p>	<p><b>Packaging Unit:</b> 5</p>
	<p><b>OEM No :</b> 0634 314 017</p>	<p><b>Model:</b> 16S 112 16S 112/1 16S 130 16S 130/1 16S 150 16S 160 16S 160/1 16S 1650 MAZ 16S 190 16S 190/1 16S 220</p>
	<p><b>EX / CROSS :</b> 0634 304 327</p>	
<p><b>T21628</b></p> 	<p><b>Description:</b> O-RING (59X2)</p>	<p><b>Packaging Unit:</b> 5</p>
	<p><b>OEM No :</b> 0634 314 018</p>	<p><b>Model:</b> 16K 130 16K 160 16K 190 16S 112 16S 112/1 16S 130 16S 130/1 16S 1300 16S 150 16S 160 16S 160/1 16S 1600 16S 160A 16S 160A/1 16S 1650 MAZ 16S 190 16S 190/1 16S 1900 16S 190A 16S 190A/1 16S 200 16S 220 16S 220A 6AS 1005TO</p>
	<p><b>EX / CROSS :</b></p>	







<p><b>T21994</b></p>	<p><b>Description:</b> O-RING (67X3)</p> <p><b>OEM No :</b> 0634 313 320</p> <p><b>EX / CROSS :</b></p>	<p><b>Packaging Unit:</b> 1</p> <p><b>Model:</b></p> <table border="0"> <tr><td>12S 2130TD</td><td>16S 151 DAF</td></tr> <tr><td>12S 2131TD IT</td><td>16S 151 HIN</td></tr> <tr><td>12S 2133TD</td><td>16S 151 HYU</td></tr> <tr><td>12S 2330TD</td><td>16S 151 IVE</td></tr> <tr><td>12S 2331TD IT</td><td>16S 151 KMZ</td></tr> <tr><td>12S 2333TD</td><td>16S 151 MAN</td></tr> <tr><td>12S 2333TD IT</td><td>16S 151 RVI</td></tr> <tr><td>12S 2333TD IT</td><td>16S 151 SNVI</td></tr> <tr><td>12S 2830TD</td><td>16S 151IT DAF</td></tr> <tr><td>12S 2831TD IT</td><td>16S 151PTO HIN</td></tr> <tr><td>12S 2833TD</td><td>16S 1620TD</td></tr> <tr><td>12S 283TD IT</td><td>16S 1621TD IT</td></tr> <tr><td>16S 151</td><td></td></tr> </table>	12S 2130TD	16S 151 DAF	12S 2131TD IT	16S 151 HIN	12S 2133TD	16S 151 HYU	12S 2330TD	16S 151 IVE	12S 2331TD IT	16S 151 KMZ	12S 2333TD	16S 151 MAN	12S 2333TD IT	16S 151 RVI	12S 2333TD IT	16S 151 SNVI	12S 2830TD	16S 151IT DAF	12S 2831TD IT	16S 151PTO HIN	12S 2833TD	16S 1620TD	12S 283TD IT	16S 1621TD IT	16S 151	
12S 2130TD	16S 151 DAF																											
12S 2131TD IT	16S 151 HIN																											
12S 2133TD	16S 151 HYU																											
12S 2330TD	16S 151 IVE																											
12S 2331TD IT	16S 151 KMZ																											
12S 2333TD	16S 151 MAN																											
12S 2333TD IT	16S 151 RVI																											
12S 2333TD IT	16S 151 SNVI																											
12S 2830TD	16S 151IT DAF																											
12S 2831TD IT	16S 151PTO HIN																											
12S 2833TD	16S 1620TD																											
12S 283TD IT	16S 1621TD IT																											
16S 151																												
<p><b>T21606</b></p>	<p><b>Description:</b> O-RING (68X4)</p> <p><b>OEM No :</b> 0634 314 015</p> <p><b>EX / CROSS :</b> 0634 313 052</p>	<p><b>Packaging Unit:</b> 1</p> <p><b>Model:</b></p> <table border="0"> <tr><td>16K 130</td><td>16S 151IT DAF</td></tr> <tr><td>16K 160</td><td>16S 160</td></tr> <tr><td>16K 190</td><td>16S 160/1</td></tr> <tr><td>16S 112</td><td>16S 1600</td></tr> <tr><td>16S 112/1</td><td>16S 1650 IVE</td></tr> <tr><td>16S 130</td><td>16S 1650 MAZ</td></tr> <tr><td>16S 130/1</td><td>16S 181</td></tr> <tr><td>16S 1300</td><td>16S 1822TO</td></tr> <tr><td>16S 150</td><td>16S 190</td></tr> <tr><td>16S 151</td><td>16S 190/1</td></tr> <tr><td>16S 151 MAN</td><td>16S 1900</td></tr> <tr><td>16S 151 SNVI</td><td>16S 1922TD</td></tr> </table>	16K 130	16S 151IT DAF	16K 160	16S 160	16K 190	16S 160/1	16S 112	16S 1600	16S 112/1	16S 1650 IVE	16S 130	16S 1650 MAZ	16S 130/1	16S 181	16S 1300	16S 1822TO	16S 150	16S 190	16S 151	16S 190/1	16S 151 MAN	16S 1900	16S 151 SNVI	16S 1922TD		
16K 130	16S 151IT DAF																											
16K 160	16S 160																											
16K 190	16S 160/1																											
16S 112	16S 1600																											
16S 112/1	16S 1650 IVE																											
16S 130	16S 1650 MAZ																											
16S 130/1	16S 181																											
16S 1300	16S 1822TO																											
16S 150	16S 190																											
16S 151	16S 190/1																											
16S 151 MAN	16S 1900																											
16S 151 SNVI	16S 1922TD																											
<p><b>T21657</b></p>	<p><b>Description:</b> O-RING (72X4)</p> <p><b>OEM No :</b> 0634 314 022</p> <p><b>EX / CROSS :</b> 0634 313 053</p>	<p><b>Packaging Unit:</b> 1</p> <p><b>Model:</b></p> <table border="0"> <tr><td>16S 112</td><td></td></tr> <tr><td>16S 112/1</td><td></td></tr> <tr><td>16S 130</td><td></td></tr> <tr><td>16S 130/1</td><td></td></tr> <tr><td>16S 160</td><td></td></tr> <tr><td>16S 160/1</td><td></td></tr> <tr><td>16S 190</td><td></td></tr> <tr><td>16S 190/1</td><td></td></tr> <tr><td>S5 42</td><td></td></tr> <tr><td>S5 42 USA</td><td></td></tr> </table>	16S 112		16S 112/1		16S 130		16S 130/1		16S 160		16S 160/1		16S 190		16S 190/1		S5 42		S5 42 USA							
16S 112																												
16S 112/1																												
16S 130																												
16S 130/1																												
16S 160																												
16S 160/1																												
16S 190																												
16S 190/1																												
S5 42																												
S5 42 USA																												
<p><b>T21597</b></p>	<p><b>Description:</b> O-RING (80X3)</p> <p><b>OEM No :</b> 0634 313 671</p> <p><b>EX / CROSS :</b></p>	<p><b>Packaging Unit:</b> 5</p> <p><b>Model:</b></p> <table border="0"> <tr><td>16K 130</td><td>16S 160A</td></tr> <tr><td>16K 160</td><td>16S 160A/1</td></tr> <tr><td>16K 190</td><td>16S 1650 MAZ</td></tr> <tr><td>16S 112</td><td>16S 190</td></tr> <tr><td>16S 112/1</td><td>16S 190/1</td></tr> <tr><td>16S 130</td><td>16S 1900</td></tr> <tr><td>16S 130/1</td><td>16S 190A</td></tr> <tr><td>16S 1300</td><td>16S 190A/1</td></tr> <tr><td>16S 150</td><td>16S 190A/1</td></tr> <tr><td>16S 160</td><td>16S 200</td></tr> <tr><td>16S 160/1</td><td>16S 220</td></tr> <tr><td>16S 1600</td><td>16S 220A</td></tr> <tr><td></td><td>8S 1350 KMZ</td></tr> </table>	16K 130	16S 160A	16K 160	16S 160A/1	16K 190	16S 1650 MAZ	16S 112	16S 190	16S 112/1	16S 190/1	16S 130	16S 1900	16S 130/1	16S 190A	16S 1300	16S 190A/1	16S 150	16S 190A/1	16S 160	16S 200	16S 160/1	16S 220	16S 1600	16S 220A		8S 1350 KMZ
16K 130	16S 160A																											
16K 160	16S 160A/1																											
16K 190	16S 1650 MAZ																											
16S 112	16S 190																											
16S 112/1	16S 190/1																											
16S 130	16S 1900																											
16S 130/1	16S 190A																											
16S 1300	16S 190A/1																											
16S 150	16S 190A/1																											
16S 160	16S 200																											
16S 160/1	16S 220																											
16S 1600	16S 220A																											
	8S 1350 KMZ																											
<p><b>T21971</b></p>	<p><b>Description:</b> O-RING (82X3)</p> <p><b>OEM No :</b> 0634 313 018</p> <p><b>EX / CROSS :</b></p>	<p><b>Packaging Unit:</b> 1</p> <p><b>Model:</b></p> <table border="0"> <tr><td>12S 2130TD</td><td>16S 151 DAF</td></tr> <tr><td>12S 2131TD IT</td><td>16S 151 HIN</td></tr> <tr><td>12S 2133TD</td><td>16S 151 HYU</td></tr> <tr><td>12S 2330TD</td><td>16S 151 IVE</td></tr> <tr><td>12S 2331TD IT</td><td>16S 151 KMZ</td></tr> <tr><td>12S 2333TD</td><td>16S 151 MAN</td></tr> <tr><td>12S 2333TD IT</td><td>16S 151 RVI</td></tr> <tr><td>12S 2333TD IT</td><td>16S 151 SNVI</td></tr> <tr><td>12S 2830TD</td><td>16S 151IT DAF</td></tr> <tr><td>12S 2831TD IT</td><td>16S 151PTO HIN</td></tr> <tr><td>12S 2833TD</td><td>16S 1620TD</td></tr> <tr><td>12S 283TD IT</td><td>16S 1621TD IT</td></tr> <tr><td>16S 151</td><td></td></tr> </table>	12S 2130TD	16S 151 DAF	12S 2131TD IT	16S 151 HIN	12S 2133TD	16S 151 HYU	12S 2330TD	16S 151 IVE	12S 2331TD IT	16S 151 KMZ	12S 2333TD	16S 151 MAN	12S 2333TD IT	16S 151 RVI	12S 2333TD IT	16S 151 SNVI	12S 2830TD	16S 151IT DAF	12S 2831TD IT	16S 151PTO HIN	12S 2833TD	16S 1620TD	12S 283TD IT	16S 1621TD IT	16S 151	
12S 2130TD	16S 151 DAF																											
12S 2131TD IT	16S 151 HIN																											
12S 2133TD	16S 151 HYU																											
12S 2330TD	16S 151 IVE																											
12S 2331TD IT	16S 151 KMZ																											
12S 2333TD	16S 151 MAN																											
12S 2333TD IT	16S 151 RVI																											
12S 2333TD IT	16S 151 SNVI																											
12S 2830TD	16S 151IT DAF																											
12S 2831TD IT	16S 151PTO HIN																											
12S 2833TD	16S 1620TD																											
12S 283TD IT	16S 1621TD IT																											
16S 151																												

<p><b>T22007</b></p> 	<p><b>Description:</b> O-RING (82X4)</p> <p><b>OEM No :</b> 0634 313 805</p> <p><b>EX / CROSS :</b></p>	<p><b>Packaging Unit:</b> 10</p> <p><b>Model:</b></p> <table border="0"> <tr> <td>10AS 2010B IT</td> <td>12 TX 1415 TD IT (1372 001 026)</td> </tr> <tr> <td>10AS 2300BO</td> <td>12 TX 1610 TO IT (1372 002 025)</td> </tr> <tr> <td>10AS 2310B</td> <td>12 TX 1610 TO IT (1372 002 045)</td> </tr> <tr> <td>10AS 2310B IT</td> <td>12 TX 1611 BO IT (1372 044 006)</td> </tr> <tr> <td>10AS 2700BO</td> <td>12 TX 1611 BO IT (1372 044 033)</td> </tr> <tr> <td>12 TX 1410 TD IT (1372 001 023)</td> <td>12 TX 1611 BO IT (1372 044 050)</td> </tr> <tr> <td>12 TX 1410 TD IT (1372 001 030)</td> <td>12 TX 1611 BO IT (1372 044 051)</td> </tr> <tr> <td>12 TX 1410 TO (1372 002 019)</td> <td></td> </tr> <tr> <td>12 TX 1411 TD IT (1372 040 027)</td> <td></td> </tr> <tr> <td>12 TX 1411 TD IT (1372 040 028)</td> <td></td> </tr> </table>	10AS 2010B IT	12 TX 1415 TD IT (1372 001 026)	10AS 2300BO	12 TX 1610 TO IT (1372 002 025)	10AS 2310B	12 TX 1610 TO IT (1372 002 045)	10AS 2310B IT	12 TX 1611 BO IT (1372 044 006)	10AS 2700BO	12 TX 1611 BO IT (1372 044 033)	12 TX 1410 TD IT (1372 001 023)	12 TX 1611 BO IT (1372 044 050)	12 TX 1410 TD IT (1372 001 030)	12 TX 1611 BO IT (1372 044 051)	12 TX 1410 TO (1372 002 019)		12 TX 1411 TD IT (1372 040 027)		12 TX 1411 TD IT (1372 040 028)					
10AS 2010B IT	12 TX 1415 TD IT (1372 001 026)																									
10AS 2300BO	12 TX 1610 TO IT (1372 002 025)																									
10AS 2310B	12 TX 1610 TO IT (1372 002 045)																									
10AS 2310B IT	12 TX 1611 BO IT (1372 044 006)																									
10AS 2700BO	12 TX 1611 BO IT (1372 044 033)																									
12 TX 1410 TD IT (1372 001 023)	12 TX 1611 BO IT (1372 044 050)																									
12 TX 1410 TD IT (1372 001 030)	12 TX 1611 BO IT (1372 044 051)																									
12 TX 1410 TO (1372 002 019)																										
12 TX 1411 TD IT (1372 040 027)																										
12 TX 1411 TD IT (1372 040 028)																										
<p><b>T21645</b></p> 	<p><b>Description:</b> O-RING (8X2)</p> <p><b>OEM No :</b> 0634 316 174</p> <p><b>EX / CROSS :</b> 0634 314 020</p>	<p><b>Packaging Unit:</b> 5</p> <p><b>Model:</b></p> <table border="0"> <tr> <td>16S 112</td> <td>16S 151 MAN</td> </tr> <tr> <td>16S 112/1</td> <td>16S 151 RVI</td> </tr> <tr> <td>16S 130</td> <td>16S 151 SNVI</td> </tr> <tr> <td>16S 130/1</td> <td>16S 151IT DAF</td> </tr> <tr> <td>16S 1300</td> <td>16S 160</td> </tr> <tr> <td>16S 150</td> <td>16S 160/1</td> </tr> <tr> <td>16S 151</td> <td>16S 1600</td> </tr> <tr> <td>16S 151 DAF</td> <td>16S 1650 MAZ</td> </tr> <tr> <td>16S 151 HIN</td> <td>16S 181</td> </tr> <tr> <td>16S 151 HYU</td> <td>16S 181 IVE</td> </tr> <tr> <td>16S 151 IVE</td> <td>16S 181 MAN</td> </tr> <tr> <td>16S 151 KMZ</td> <td>16S 181 RVI</td> </tr> </table>	16S 112	16S 151 MAN	16S 112/1	16S 151 RVI	16S 130	16S 151 SNVI	16S 130/1	16S 151IT DAF	16S 1300	16S 160	16S 150	16S 160/1	16S 151	16S 1600	16S 151 DAF	16S 1650 MAZ	16S 151 HIN	16S 181	16S 151 HYU	16S 181 IVE	16S 151 IVE	16S 181 MAN	16S 151 KMZ	16S 181 RVI
16S 112	16S 151 MAN																									
16S 112/1	16S 151 RVI																									
16S 130	16S 151 SNVI																									
16S 130/1	16S 151IT DAF																									
16S 1300	16S 160																									
16S 150	16S 160/1																									
16S 151	16S 1600																									
16S 151 DAF	16S 1650 MAZ																									
16S 151 HIN	16S 181																									
16S 151 HYU	16S 181 IVE																									
16S 151 IVE	16S 181 MAN																									
16S 151 KMZ	16S 181 RVI																									
<p><b>T21636</b></p> 	<p><b>Description:</b> O-RING (94X3)</p> <p><b>OEM No :</b> 0634 314 019</p> <p><b>EX / CROSS :</b> 0634 313 734</p>	<p><b>Packaging Unit:</b> 5</p> <p><b>Model:</b></p> <table border="0"> <tr> <td>16K 130</td> <td>16S 160A</td> </tr> <tr> <td>16K 160</td> <td>16S 160A/1</td> </tr> <tr> <td>16K 190</td> <td>16S 1650 MAZ</td> </tr> <tr> <td>16S 112</td> <td>16S 190</td> </tr> <tr> <td>16S 112/1</td> <td>16S 190/1</td> </tr> <tr> <td>16S 130</td> <td>16S 1900</td> </tr> <tr> <td>16S 130/1</td> <td>16S 190A</td> </tr> <tr> <td>16S 1300</td> <td>16S 200</td> </tr> <tr> <td>16S 150</td> <td>16S 220</td> </tr> <tr> <td>16S 160</td> <td>8S 1350 KMZ</td> </tr> <tr> <td>16S 160/1</td> <td>8S 190</td> </tr> <tr> <td>16S 1600</td> <td></td> </tr> </table>	16K 130	16S 160A	16K 160	16S 160A/1	16K 190	16S 1650 MAZ	16S 112	16S 190	16S 112/1	16S 190/1	16S 130	16S 1900	16S 130/1	16S 190A	16S 1300	16S 200	16S 150	16S 220	16S 160	8S 1350 KMZ	16S 160/1	8S 190	16S 1600	
16K 130	16S 160A																									
16K 160	16S 160A/1																									
16K 190	16S 1650 MAZ																									
16S 112	16S 190																									
16S 112/1	16S 190/1																									
16S 130	16S 1900																									
16S 130/1	16S 190A																									
16S 1300	16S 200																									
16S 150	16S 220																									
16S 160	8S 1350 KMZ																									
16S 160/1	8S 190																									
16S 1600																										
<p><b>T76146</b></p> 	<p><b>Description:</b> O-RINGS AND OIL SEALS KIT</p> <p><b>OEM No :</b> 1325 298 011</p> <p><b>EX / CROSS :</b></p>	<p><b>Packaging Unit:</b> 1</p> <p><b>Model:</b></p> <table border="0"> <tr> <td>12S 2130TD</td> <td>16S 1930TD</td> </tr> <tr> <td>12S 2131TD IT</td> <td>16S 1931TD IT</td> </tr> <tr> <td>12S 2133TD</td> <td>16S 1933TD</td> </tr> <tr> <td>12S 2330TD</td> <td>16S 1935TD</td> </tr> <tr> <td>12S 2331TD IT</td> <td>16S 2220TD</td> </tr> <tr> <td>12S 2333TD</td> <td>16S 2220TO</td> </tr> <tr> <td>16S 1620TD</td> <td>16S 2221TD IT</td> </tr> <tr> <td>16S 1621TD IT</td> <td>16S 2221TO IT</td> </tr> <tr> <td>16S 1631TD IT</td> <td>16S 2230TD</td> </tr> <tr> <td>16S 1830TO</td> <td>16S 2230TO</td> </tr> <tr> <td>16S 1831TO IT</td> <td>16S 2231TD IT</td> </tr> <tr> <td>16S 1833TO</td> <td>16S 2231TO IT</td> </tr> </table>	12S 2130TD	16S 1930TD	12S 2131TD IT	16S 1931TD IT	12S 2133TD	16S 1933TD	12S 2330TD	16S 1935TD	12S 2331TD IT	16S 2220TD	12S 2333TD	16S 2220TO	16S 1620TD	16S 2221TD IT	16S 1621TD IT	16S 2221TO IT	16S 1631TD IT	16S 2230TD	16S 1830TO	16S 2230TO	16S 1831TO IT	16S 2231TD IT	16S 1833TO	16S 2231TO IT
12S 2130TD	16S 1930TD																									
12S 2131TD IT	16S 1931TD IT																									
12S 2133TD	16S 1933TD																									
12S 2330TD	16S 1935TD																									
12S 2331TD IT	16S 2220TD																									
12S 2333TD	16S 2220TO																									
16S 1620TD	16S 2221TD IT																									
16S 1621TD IT	16S 2221TO IT																									
16S 1631TD IT	16S 2230TD																									
16S 1830TO	16S 2230TO																									
16S 1831TO IT	16S 2231TD IT																									
16S 1833TO	16S 2231TO IT																									
<p><b>T62175</b></p> 	<p><b>Description:</b> OIL FILTER</p> <p><b>OEM No :</b> 0501 215 163</p> <p><b>EX / CROSS :</b> 5961 307 148</p>	<p><b>Packaging Unit:</b> 1</p> <p><b>Model:</b></p> <table border="0"> <tr> <td>12 TX 1411 TD IT (1372 040 028) INT</td> <td>12 TX 1811 TO IT (1372 041 035) INT</td> </tr> <tr> <td>12 TX 1411 TD IT (1372 040 029) INT</td> <td>12 TX 1811 TO IT (1372 041 041) INT</td> </tr> <tr> <td>12 TX 1811 TD IT (1372 040 030) INT</td> <td>12 TX 1811 TO IT (1372 041 042) INT</td> </tr> <tr> <td>12 TX 1811 TD IT (1372 040 031) INT</td> <td>12 TX 1811 TO IT (1372 041 045) INT</td> </tr> <tr> <td>12 TX 1811 TD IT (1372 040 040) INT</td> <td>12 TX 2421 TD IT (1358 040 038) INT</td> </tr> <tr> <td>12 TX 1811 TD IT (1372 040 043) INT</td> <td>12 TX 2421 TD IT (1358 040 050) INT</td> </tr> </table>	12 TX 1411 TD IT (1372 040 028) INT	12 TX 1811 TO IT (1372 041 035) INT	12 TX 1411 TD IT (1372 040 029) INT	12 TX 1811 TO IT (1372 041 041) INT	12 TX 1811 TD IT (1372 040 030) INT	12 TX 1811 TO IT (1372 041 042) INT	12 TX 1811 TD IT (1372 040 031) INT	12 TX 1811 TO IT (1372 041 045) INT	12 TX 1811 TD IT (1372 040 040) INT	12 TX 2421 TD IT (1358 040 038) INT	12 TX 1811 TD IT (1372 040 043) INT	12 TX 2421 TD IT (1358 040 050) INT												
12 TX 1411 TD IT (1372 040 028) INT	12 TX 1811 TO IT (1372 041 035) INT																									
12 TX 1411 TD IT (1372 040 029) INT	12 TX 1811 TO IT (1372 041 041) INT																									
12 TX 1811 TD IT (1372 040 030) INT	12 TX 1811 TO IT (1372 041 042) INT																									
12 TX 1811 TD IT (1372 040 031) INT	12 TX 1811 TO IT (1372 041 045) INT																									
12 TX 1811 TD IT (1372 040 040) INT	12 TX 2421 TD IT (1358 040 038) INT																									
12 TX 1811 TD IT (1372 040 043) INT	12 TX 2421 TD IT (1358 040 050) INT																									







<p><b>T09751</b></p> 	<p><b>Description:</b> OIL PUMP</p> <p><b>OEM No :</b> 1295 202 041</p> <p><b>EX / CROSS :</b> 0091 202 057 1269 202 087 1269 202 093 1295 202 035</p>	<p><b>Packaging Unit:</b> 1</p> <p><b>Model:</b></p>
<p><b>T08829</b></p> 	<p><b>Description:</b> OIL PUMP</p> <p><b>OEM No :</b> 1269 202 104</p> <p><b>EX / CROSS :</b> 1269 202 027 1269 202 033</p>	<p><b>Packaging Unit:</b> 1</p> <p><b>Model:</b></p>
<p><b>T58905</b></p> 	<p><b>Description:</b> OIL PUMP</p> <p><b>OEM No :</b> 0501 215 245</p> <p><b>EX / CROSS :</b></p>	<p><b>Packaging Unit:</b> 1</p> <p><b>Model:</b> 9S 1110TD 9S 1115TD 9S 1310TO 9S 1315TO</p>
<p><b>T65816</b></p> 	<p><b>Description:</b> OIL PUMP</p> <p><b>OEM No :</b> 1304 403 204</p> <p><b>EX / CROSS :</b></p>	<p><b>Packaging Unit:</b> 1</p> <p><b>Model:</b> 16S 109 6S 150C 8S 109 8S 140 9S 109</p>
<p><b>T20143</b></p> 	<p><b>Description:</b> OIL PUMP BODY</p> <p><b>OEM No :</b> 1315 302 121</p> <p><b>EX / CROSS :</b> 1315 302 117</p>	<p><b>Packaging Unit:</b> 1</p> <p><b>Model:</b> 16S 151 16S 151 DAF 16S 151 HIN 16S 151 HYU 16S 151 IVE 16S 151 KMZ 16S 151 MAN 16S 151 RVI 16S 151 SNVI 16S 151IT DAF 16S 151PTO HIN 16S 1620TD 16S 1621TD IT 16S 1625TD 16S 162TD IT 16S 1685 16S 181 16S 181 IVE 16S 181 MAN 16S 181 RVI 16S 181IT DAF 16S 182 16S 1820TO 16S 1820TO KMZ</p>

<p><b>T20138</b></p> 	<p><b>Description:</b> OIL PUMP COVER</p> <p><b>OEM No :</b> 1315 302 120</p> <p><b>EX / CROSS :</b> 1315 302 116</p>	<p><b>Packaging Unit:</b> 1</p> <p><b>Model:</b></p> <table border="0"> <tr><td>16S 151</td><td>16S 1621TD IT</td></tr> <tr><td>16S 151 DAF</td><td>16S 1625TD</td></tr> <tr><td>16S 151 HIN</td><td>16S 162TD IT</td></tr> <tr><td>16S 151 HYU</td><td>16S 1685</td></tr> <tr><td>16S 151 IVE</td><td>16S 181</td></tr> <tr><td>16S 151 KMZ</td><td>16S 181 IVE</td></tr> <tr><td>16S 151 MAN</td><td>16S 181 MAN</td></tr> <tr><td>16S 151 RVI</td><td>16S 181 RVI</td></tr> <tr><td>16S 151 SNVI</td><td>16S 181IT DAF</td></tr> <tr><td>16S 151IT DAF</td><td>16S 182</td></tr> <tr><td>16S 151PTO HIN</td><td>16S 1820TO</td></tr> <tr><td>16S 1620TD</td><td>16S 1820TO KMZ</td></tr> </table>	16S 151	16S 1621TD IT	16S 151 DAF	16S 1625TD	16S 151 HIN	16S 162TD IT	16S 151 HYU	16S 1685	16S 151 IVE	16S 181	16S 151 KMZ	16S 181 IVE	16S 151 MAN	16S 181 MAN	16S 151 RVI	16S 181 RVI	16S 151 SNVI	16S 181IT DAF	16S 151IT DAF	16S 182	16S 151PTO HIN	16S 1820TO	16S 1620TD	16S 1820TO KMZ
16S 151	16S 1621TD IT																									
16S 151 DAF	16S 1625TD																									
16S 151 HIN	16S 162TD IT																									
16S 151 HYU	16S 1685																									
16S 151 IVE	16S 181																									
16S 151 KMZ	16S 181 IVE																									
16S 151 MAN	16S 181 MAN																									
16S 151 RVI	16S 181 RVI																									
16S 151 SNVI	16S 181IT DAF																									
16S 151IT DAF	16S 182																									
16S 151PTO HIN	16S 1820TO																									
16S 1620TD	16S 1820TO KMZ																									
<p><b>T60363</b></p> 	<p><b>Description:</b> OIL PUMP COVER</p> <p><b>OEM No :</b> 1325 303 017</p> <p><b>EX / CROSS :</b></p>	<p><b>Packaging Unit:</b> 1</p> <p><b>Model:</b></p> <table border="0"> <tr><td>12S 2130TD</td><td>16S 1621TD IT</td></tr> <tr><td>12S 2131TD IT</td><td>16S 1625TD</td></tr> <tr><td>12S 2133TD</td><td>16S 162TD IT</td></tr> <tr><td>12S 2330TD</td><td>16S 1630TD</td></tr> <tr><td>12S 2331TD IT</td><td>16S 1631TD IT</td></tr> <tr><td>12S 2333TD</td><td>16S 1635TD</td></tr> <tr><td>12S 233TD IT</td><td>16S 163TD IT</td></tr> <tr><td>12S 2830TD</td><td>16S 1820TO</td></tr> <tr><td>12S 2831TD IT</td><td>16S 1821TO IT</td></tr> <tr><td>12S 2833TD</td><td>16S 182TO IT</td></tr> <tr><td>12S 283TD IT</td><td>16S 1830TO</td></tr> <tr><td>16S 1620TD</td><td>16S 1831TO IT</td></tr> </table>	12S 2130TD	16S 1621TD IT	12S 2131TD IT	16S 1625TD	12S 2133TD	16S 162TD IT	12S 2330TD	16S 1630TD	12S 2331TD IT	16S 1631TD IT	12S 2333TD	16S 1635TD	12S 233TD IT	16S 163TD IT	12S 2830TD	16S 1820TO	12S 2831TD IT	16S 1821TO IT	12S 2833TD	16S 182TO IT	12S 283TD IT	16S 1830TO	16S 1620TD	16S 1831TO IT
12S 2130TD	16S 1621TD IT																									
12S 2131TD IT	16S 1625TD																									
12S 2133TD	16S 162TD IT																									
12S 2330TD	16S 1630TD																									
12S 2331TD IT	16S 1631TD IT																									
12S 2333TD	16S 1635TD																									
12S 233TD IT	16S 163TD IT																									
12S 2830TD	16S 1820TO																									
12S 2831TD IT	16S 1821TO IT																									
12S 2833TD	16S 182TO IT																									
12S 283TD IT	16S 1830TO																									
16S 1620TD	16S 1831TO IT																									
<p><b>T57321</b></p> 	<p><b>Description:</b> OIL PUMP COVER</p> <p><b>OEM No :</b> 1328 302 203</p> <p><b>EX / CROSS :</b> 1314 302 138</p>	<p><b>Packaging Unit:</b> 1</p> <p><b>Model:</b></p> <table border="0"> <tr><td>10AS 2010B IT</td><td>12AS 1931TD IT</td></tr> <tr><td>10AS 2300BO</td><td>12AS 1931TO IT</td></tr> <tr><td>10AS 2310B</td><td>12AS 1935TD</td></tr> <tr><td>10AS 2310B IT</td><td>12AS 2000B IT</td></tr> <tr><td>10AS 2700BO</td><td>12AS 2000BO</td></tr> <tr><td>12AS 1601BO IT</td><td>12AS 2001BO IT</td></tr> <tr><td>12AS 1630TD</td><td>12AS 2130TD</td></tr> <tr><td>12AS 1631TD IT</td><td>12AS 2130TO</td></tr> <tr><td>12AS 1800</td><td>12AS 2131TD IT</td></tr> <tr><td>12AS 1800IT</td><td>12AS 2131TO IT</td></tr> <tr><td>12AS 1930TD</td><td>12AS 2140TD</td></tr> <tr><td>12AS 1930TO</td><td>12AS 2300B IT</td></tr> </table>	10AS 2010B IT	12AS 1931TD IT	10AS 2300BO	12AS 1931TO IT	10AS 2310B	12AS 1935TD	10AS 2310B IT	12AS 2000B IT	10AS 2700BO	12AS 2000BO	12AS 1601BO IT	12AS 2001BO IT	12AS 1630TD	12AS 2130TD	12AS 1631TD IT	12AS 2130TO	12AS 1800	12AS 2131TD IT	12AS 1800IT	12AS 2131TO IT	12AS 1930TD	12AS 2140TD	12AS 1930TO	12AS 2300B IT
10AS 2010B IT	12AS 1931TD IT																									
10AS 2300BO	12AS 1931TO IT																									
10AS 2310B	12AS 1935TD																									
10AS 2310B IT	12AS 2000B IT																									
10AS 2700BO	12AS 2000BO																									
12AS 1601BO IT	12AS 2001BO IT																									
12AS 1630TD	12AS 2130TD																									
12AS 1631TD IT	12AS 2130TO																									
12AS 1800	12AS 2131TD IT																									
12AS 1800IT	12AS 2131TO IT																									
12AS 1930TD	12AS 2140TD																									
12AS 1930TO	12AS 2300B IT																									
<p><b>T20132</b></p> 	<p><b>Description:</b> OIL PUMP DRIVE GEAR AND SHAFT (6T.)</p> <p><b>OEM No :</b> 1314 202 039</p> <p><b>EX / CROSS :</b> 1315 202 018</p>	<p><b>Packaging Unit:</b> 1</p> <p><b>Model:</b></p> <table border="0"> <tr><td>10AS 2010B IT</td><td>12AS 1931TD IT</td></tr> <tr><td>10AS 2300BO</td><td>12AS 1931TO IT</td></tr> <tr><td>10AS 2310B</td><td>12AS 1935TD</td></tr> <tr><td>10AS 2310B IT</td><td>12AS 2000B IT</td></tr> <tr><td>10AS 2700BO</td><td>12AS 2000BO</td></tr> <tr><td>12AS 1601BO IT</td><td>12AS 2001BO IT</td></tr> <tr><td>12AS 1630TD</td><td>12AS 2130TD</td></tr> <tr><td>12AS 1631TD IT</td><td>12AS 2130TO</td></tr> <tr><td>12AS 1800</td><td>12AS 2131TD IT</td></tr> <tr><td>12AS 1800IT</td><td>12AS 2131TO IT</td></tr> <tr><td>12AS 1930TD</td><td>12AS 2140TD</td></tr> <tr><td>12AS 1930TO</td><td>12AS 2300B IT</td></tr> </table>	10AS 2010B IT	12AS 1931TD IT	10AS 2300BO	12AS 1931TO IT	10AS 2310B	12AS 1935TD	10AS 2310B IT	12AS 2000B IT	10AS 2700BO	12AS 2000BO	12AS 1601BO IT	12AS 2001BO IT	12AS 1630TD	12AS 2130TD	12AS 1631TD IT	12AS 2130TO	12AS 1800	12AS 2131TD IT	12AS 1800IT	12AS 2131TO IT	12AS 1930TD	12AS 2140TD	12AS 1930TO	12AS 2300B IT
10AS 2010B IT	12AS 1931TD IT																									
10AS 2300BO	12AS 1931TO IT																									
10AS 2310B	12AS 1935TD																									
10AS 2310B IT	12AS 2000B IT																									
10AS 2700BO	12AS 2000BO																									
12AS 1601BO IT	12AS 2001BO IT																									
12AS 1630TD	12AS 2130TD																									
12AS 1631TD IT	12AS 2130TO																									
12AS 1800	12AS 2131TD IT																									
12AS 1800IT	12AS 2131TO IT																									
12AS 1930TD	12AS 2140TD																									
12AS 1930TO	12AS 2300B IT																									
<p><b>T20148</b></p> 	<p><b>Description:</b> OIL PUMP DRIVEN GEAR (7T.)</p> <p><b>OEM No :</b> 1315 303 027</p> <p><b>EX / CROSS :</b></p>	<p><b>Packaging Unit:</b> 1</p> <p><b>Model:</b></p> <table border="0"> <tr><td>10AS 2010B IT</td><td>12AS 1631TD IT</td></tr> <tr><td>10AS 2300BO</td><td>12AS 1800</td></tr> <tr><td>10AS 2310B</td><td>12AS 1800IT</td></tr> <tr><td>10AS 2310B IT</td><td>12AS 1930TD</td></tr> <tr><td>10AS 2700BO</td><td>12AS 1930TO</td></tr> <tr><td>12AS 1210TO</td><td>12AS 1931TD IT</td></tr> <tr><td>12AS 1220TD</td><td>12AS 1931TO IT</td></tr> <tr><td>12AS 1420TD</td><td>12AS 1935TD</td></tr> <tr><td>12AS 1420TO</td><td>12AS 2000B IT</td></tr> <tr><td>12AS 1601BO IT</td><td>12AS 2000BO</td></tr> <tr><td>12AS 1620TO</td><td>12AS 2001BO IT</td></tr> <tr><td>12AS 1630TD</td><td>12AS 2130TD</td></tr> </table>	10AS 2010B IT	12AS 1631TD IT	10AS 2300BO	12AS 1800	10AS 2310B	12AS 1800IT	10AS 2310B IT	12AS 1930TD	10AS 2700BO	12AS 1930TO	12AS 1210TO	12AS 1931TD IT	12AS 1220TD	12AS 1931TO IT	12AS 1420TD	12AS 1935TD	12AS 1420TO	12AS 2000B IT	12AS 1601BO IT	12AS 2000BO	12AS 1620TO	12AS 2001BO IT	12AS 1630TD	12AS 2130TD
10AS 2010B IT	12AS 1631TD IT																									
10AS 2300BO	12AS 1800																									
10AS 2310B	12AS 1800IT																									
10AS 2310B IT	12AS 1930TD																									
10AS 2700BO	12AS 1930TO																									
12AS 1210TO	12AS 1931TD IT																									
12AS 1220TD	12AS 1931TO IT																									
12AS 1420TD	12AS 1935TD																									
12AS 1420TO	12AS 2000B IT																									
12AS 1601BO IT	12AS 2000BO																									
12AS 1620TO	12AS 2001BO IT																									
12AS 1630TD	12AS 2130TD																									







<p><b>T75906</b></p> 	<p><b>Description:</b> OIL PUMP GEAR</p> <p><b>OEM No :</b> 0501 215 062</p> <p><b>EX / CROSS :</b></p>	<p><b>Packaging Unit:</b></p> <p><b>Model:</b></p>																								
<p><b>T85645</b></p> 	<p><b>Description:</b> OIL PUMP KIT FOR ECOSPLIT</p> <p><b>OEM No :</b> TAS49334</p> <p><b>EX / CROSS :</b></p>	<p><b>Packaging Unit:</b> 1</p> <p><b>Model:</b></p> <table border="0"> <tr> <td>16S 151 DAF</td> <td>16S 181 RVI</td> </tr> <tr> <td>16S 151 HIN</td> <td>16S 181IT DAF</td> </tr> <tr> <td>16S 151 HYU</td> <td>16S 1820TO KMZ</td> </tr> <tr> <td>16S 151 IVE</td> <td>16S 1820TO RVI</td> </tr> <tr> <td>16S 151 KMZ</td> <td>16S 221 DAF</td> </tr> <tr> <td>16S 151 MAN</td> <td>16S 221 IVE</td> </tr> <tr> <td>16S 151 RVI</td> <td>16S 221 MAN</td> </tr> <tr> <td>16S 151 SNVI</td> <td>16S 221 MB</td> </tr> <tr> <td>16S 151IT DAF</td> <td>16S 221 RVI</td> </tr> <tr> <td>16S 151PTO HIN</td> <td>16S 221IT IVE</td> </tr> <tr> <td>16S 181 IVE</td> <td>16S 221IT RVI</td> </tr> <tr> <td>16S 181 MAN</td> <td>16S 251 NIS</td> </tr> </table>	16S 151 DAF	16S 181 RVI	16S 151 HIN	16S 181IT DAF	16S 151 HYU	16S 1820TO KMZ	16S 151 IVE	16S 1820TO RVI	16S 151 KMZ	16S 221 DAF	16S 151 MAN	16S 221 IVE	16S 151 RVI	16S 221 MAN	16S 151 SNVI	16S 221 MB	16S 151IT DAF	16S 221 RVI	16S 151PTO HIN	16S 221IT IVE	16S 181 IVE	16S 221IT RVI	16S 181 MAN	16S 251 NIS
16S 151 DAF	16S 181 RVI																									
16S 151 HIN	16S 181IT DAF																									
16S 151 HYU	16S 1820TO KMZ																									
16S 151 IVE	16S 1820TO RVI																									
16S 151 KMZ	16S 221 DAF																									
16S 151 MAN	16S 221 IVE																									
16S 151 RVI	16S 221 MAN																									
16S 151 SNVI	16S 221 MB																									
16S 151IT DAF	16S 221 RVI																									
16S 151PTO HIN	16S 221IT IVE																									
16S 181 IVE	16S 221IT RVI																									
16S 181 MAN	16S 251 NIS																									
<p><b>T39312</b></p> 	<p><b>Description:</b> OIL SEAL RING</p> <p><b>OEM No :</b> 0750 190 014</p> <p><b>EX / CROSS :</b> 0750 112 239 0501 316 778 0501 314 772 0501 311 036</p>	<p><b>Packaging Unit:</b> 1</p> <p><b>Model:</b></p>																								
<p><b>T18524</b></p> 	<p><b>Description:</b> OIL SEAL RING</p> <p><b>OEM No :</b> 0501 325 930</p> <p><b>EX / CROSS :</b> 0501 314 060 0501 320 435 0750 101 179</p>	<p><b>Packaging Unit:</b> 5</p> <p><b>Model:</b></p> <table border="0"> <tr> <td>16S 151 DAF</td> <td>16S 181 MAN</td> </tr> <tr> <td>16S 151 HIN</td> <td>16S 181 RVI</td> </tr> <tr> <td>16S 151 HYU</td> <td>16S 181IT DAF</td> </tr> <tr> <td>16S 151 IVE</td> <td>16S 221 DAF</td> </tr> <tr> <td>16S 151 KMZ</td> <td>16S 221 IVE</td> </tr> <tr> <td>16S 151 MAN</td> <td>16S 221 MAN</td> </tr> <tr> <td>16S 151 RVI</td> <td>16S 221 MB</td> </tr> <tr> <td>16S 151 SNVI</td> <td>16S 221 RVI</td> </tr> <tr> <td>16S 151IT DAF</td> <td>16S 221IT IVE</td> </tr> <tr> <td>16S 151PTO HIN</td> <td>16S 221IT RVI</td> </tr> <tr> <td>16S 1685</td> <td>16S 2280TO</td> </tr> <tr> <td>16S 181 IVE</td> <td>16S 251 NIS</td> </tr> </table>	16S 151 DAF	16S 181 MAN	16S 151 HIN	16S 181 RVI	16S 151 HYU	16S 181IT DAF	16S 151 IVE	16S 221 DAF	16S 151 KMZ	16S 221 IVE	16S 151 MAN	16S 221 MAN	16S 151 RVI	16S 221 MB	16S 151 SNVI	16S 221 RVI	16S 151IT DAF	16S 221IT IVE	16S 151PTO HIN	16S 221IT RVI	16S 1685	16S 2280TO	16S 181 IVE	16S 251 NIS
16S 151 DAF	16S 181 MAN																									
16S 151 HIN	16S 181 RVI																									
16S 151 HYU	16S 181IT DAF																									
16S 151 IVE	16S 221 DAF																									
16S 151 KMZ	16S 221 IVE																									
16S 151 MAN	16S 221 MAN																									
16S 151 RVI	16S 221 MB																									
16S 151 SNVI	16S 221 RVI																									
16S 151IT DAF	16S 221IT IVE																									
16S 151PTO HIN	16S 221IT RVI																									
16S 1685	16S 2280TO																									
16S 181 IVE	16S 251 NIS																									
<p><b>T20829</b></p> 	<p><b>Description:</b> OIL SEAL RING</p> <p><b>OEM No :</b> 0734 307 294</p> <p><b>EX / CROSS :</b> 0734 307 280</p>	<p><b>Packaging Unit:</b> 1</p> <p><b>Model:</b></p> <table border="0"> <tr> <td>12S 2130TD</td> <td>16S 151 DAF</td> </tr> <tr> <td>12S 2131TD IT</td> <td>16S 151 HIN</td> </tr> <tr> <td>12S 2133TD</td> <td>16S 151 HYU</td> </tr> <tr> <td>12S 2330TD</td> <td>16S 151 IVE</td> </tr> <tr> <td>12S 2331TD IT</td> <td>16S 151 KMZ</td> </tr> <tr> <td>12S 2333TD</td> <td>16S 151 MAN</td> </tr> <tr> <td>12S 2333TD IT</td> <td>16S 151 RVI</td> </tr> <tr> <td>12S 2830TD</td> <td>16S 151 SNVI</td> </tr> <tr> <td>12S 2831TD IT</td> <td>16S 151IT DAF</td> </tr> <tr> <td>12S 2833TD</td> <td>16S 151PTO HIN</td> </tr> <tr> <td>12S 2833TD IT</td> <td>16S 1620TD</td> </tr> <tr> <td>16S 151</td> <td>16S 1621TD IT</td> </tr> </table>	12S 2130TD	16S 151 DAF	12S 2131TD IT	16S 151 HIN	12S 2133TD	16S 151 HYU	12S 2330TD	16S 151 IVE	12S 2331TD IT	16S 151 KMZ	12S 2333TD	16S 151 MAN	12S 2333TD IT	16S 151 RVI	12S 2830TD	16S 151 SNVI	12S 2831TD IT	16S 151IT DAF	12S 2833TD	16S 151PTO HIN	12S 2833TD IT	16S 1620TD	16S 151	16S 1621TD IT
12S 2130TD	16S 151 DAF																									
12S 2131TD IT	16S 151 HIN																									
12S 2133TD	16S 151 HYU																									
12S 2330TD	16S 151 IVE																									
12S 2331TD IT	16S 151 KMZ																									
12S 2333TD	16S 151 MAN																									
12S 2333TD IT	16S 151 RVI																									
12S 2830TD	16S 151 SNVI																									
12S 2831TD IT	16S 151IT DAF																									
12S 2833TD	16S 151PTO HIN																									
12S 2833TD IT	16S 1620TD																									
16S 151	16S 1621TD IT																									

<p><b>T21786</b></p> 	<p><b>Description:</b> OIL SEAL RING</p> <p><b>Packaging Unit:</b> 5</p> <p><b>OEM No :</b> 0750 112 066</p> <p><b>EX / CROSS :</b> 0501 307 769</p> <p><b>Model:</b> 12S 2130TD 12S 2131TD IT 12S 2133TD 12S 2330TD 12S 2331TD IT 12S 2333TD 12S 2333TD IT 12S 2830TD 12S 2831TD IT 12S 2833TD 12S 2833TD IT 16K 130</p> <p>16K 160 16K 190 16S 112 16S 112/1 16S 130 16S 130/1 16S 1300 16S 150 16S 151 16S 151 DAF 16S 151 HIN 16S 151 HYU</p>
<p><b>T20762</b></p> 	<p><b>Description:</b> OIL SEAL RING (105X125X12)</p> <p><b>Packaging Unit:</b> 1</p> <p><b>OEM No :</b> 0734 319 459</p> <p><b>EX / CROSS :</b></p> <p><b>Model:</b> 10AS 2010B IT 10AS 2310B IT 12AS 1601BO IT 12AS 1630TD 12AS 1631TD IT 12AS 1800IT 12AS 1930TD 12AS 1930TO 12AS 1931TD IT 12AS 1931TO IT 12AS 1935TD 12AS 2000B IT</p> <p>12AS 2001BO IT 12AS 2131TD IT 12AS 2131TO IT 12AS 2300B IT 12AS 2301BO IT 12AS 2301IT 12AS 2302 12AS 2330TO 12AS 2331TD IT 12AS 2331TO IT 12AS 2335TO 12AS 2341TD IT</p>
<p><b>T57520</b></p> 	<p><b>Description:</b> OIL SEAL RING (105X125X12/16)</p> <p><b>Packaging Unit:</b> 1</p> <p><b>OEM No :</b> 0734 300 421</p> <p><b>EX / CROSS :</b> 0768 800 001 0734 300 679 0769 174 312</p> <p><b>Model:</b> 10AS 2010B IT 10AS 2300BO 10AS 2310B 10AS 2310B IT 10AS 2700BO 12 TX 1410 TD IT (1372 001 023) 12 TX 1410 TD IT (1372 001 030) 12 TX 1410 TO (1372 002 019) 12 TX 1411 TD IT (1372 040 028) INT 12 TX 1411 TD IT (1372 040 029) INT</p> <p>12 TX 1415 TD IT (1372 001 026) S/PUMP 12 TX 1610 TO IT (1372 002 025) 12 TX 1610 TO IT (1372 002 045) 12 TX 1810 TD IT (1372 001 031) 12 TX 1810 TD IT (1372 001 037) 12 TX 1810 TD IT (1372 001 042) 12 TX 1810 TO (1372 002 018) 12 TX 1810 TO (1372 002 021)</p>
<p><b>T20768</b></p> 	<p><b>Description:</b> OIL SEAL RING (105X130X12/9,5)</p> <p><b>Packaging Unit:</b> 5</p> <p><b>OEM No :</b> 0750 111 341</p> <p><b>EX / CROSS :</b> 0734 300 095 0734 300 102 0734 310 116 0734 319 253</p> <p><b>Model:</b> 16K 130 16K 160 16K 190 16S 112 16S 112/1 16S 130 16S 130/1 16S 150 16S 151 16S 151 DAF 16S 151 HIN 16S 151 HYU</p> <p>16S 151 IVE 16S 151 KMZ 16S 151 MAN 16S 151 RVI 16S 151 SNVI 16S 151PTO HIN 16S 160 16S 160/1 16S 1620TD 16S 1625TD 16S 1650 MAZ 16S 181</p>
<p><b>T21067</b></p> 	<p><b>Description:</b> OIL SEAL RING (10X15X3)</p> <p><b>Packaging Unit:</b> 1</p> <p><b>OEM No :</b> 0634 300 185</p> <p><b>EX / CROSS :</b> 0501 398 018</p> <p><b>Model:</b> 5S 111GP 5S 111GP+GV90 5S 111GPA 9S 1110TD 9S 1115TD 9S 1310TO AK5 35/2 AK6 65 AK6 65+GV80 S5 35/2 S5 42 S5 42 SNVI</p> <p>S5 42 USA S6 65 S6 65+GV80 S6 90 SETRA S6 90+GV90 SNVI</p>



<p><b>T21011</b></p> 	<p><b>Description:</b> OIL SEAL RING (22X36X14,5)</p> <p><b>OEM No :</b> 0750 112 047</p> <p><b>EX / CROSS :</b></p>	<p><b>Packaging Unit:</b> 10</p> <p><b>Model:</b> 16S 109 16S 109 STR 6S 150C 8S 109 8S 140 8S 180 8S 180 ENASA 8S 2100 8S 2100BD 8S 2100BO 8S 2101BD IT 8S 2101BO IT</p> <p>9S 109 9S 109 MAN 9S 109 SNVI 9S 1110TD 9S 1110TO 9S 1111TD IT 9S 1111TO IT 9S 1115TD 9S 1115TO 9S 1310TO 9S 1310TO KMZ 9S 1311TO IT</p>
<p><b>T21769</b></p> 	<p><b>Description:</b> OIL SEAL RING (25X28X14,2)</p> <p><b>OEM No :</b> 0750 112 034</p> <p><b>EX / CROSS :</b> 0501 306 439 0501 309 420 0501 309 421 0501 398 042</p>	<p><b>Packaging Unit:</b> 5</p> <p><b>Model:</b> 16K 130 16K 160 16K 190 16S 112 16S 112/1 16S 130 16S 130/1 16S 150 16S 151 16S 151 MAN 16S 160 16S 160/1</p> <p>16S 160A 16S 160A/1 16S 1650 16S 1650 IVE 16S 1650 MAZ 16S 181 16S 190 16S 190/1 16S 190A 16S 190A/1 16S 200 16S 220</p>
<p><b>T21588</b></p> 	<p><b>Description:</b> OIL SEAL RING (25X32X5)</p> <p><b>OEM No :</b> 0634 300 020</p> <p><b>EX / CROSS :</b></p>	<p><b>Packaging Unit:</b> 1</p> <p><b>Model:</b> 16K 130 16K 160 16K 190 16S 109 STR 16S 112 16S 112/1 16S 130 16S 130/1 16S 150 16S 151 16S 151 DAF 16S 151 MAN</p> <p>16S 151 SNVI 16S 151IT DAF 16S 160 16S 160/1 16S 181 16S 181IT DAF 16S 190 16S 190/1 16S 190A 16S 220 16S 220A 16S 221</p>
<p><b>T21967</b></p> 	<p><b>Description:</b> OIL SEAL RING (25X33X7/4,5)</p> <p><b>OEM No :</b> 0634 312 523</p> <p><b>EX / CROSS :</b></p>	<p><b>Packaging Unit:</b> 1</p> <p><b>Model:</b> 16S 151 16S 151 DAF 16S 151 MAN 16S 151IT DAF 16S 181 16S 181IT DAF 16S 221 16S 221 DAF 16S 251 8S 151 8S 151 DAF Ecosplit III</p>
<p><b>T21080</b></p> 	<p><b>Description:</b> OIL SEAL RING (25X35X7)</p> <p><b>OEM No :</b> 0634 300 302</p> <p><b>EX / CROSS :</b> 0734 300 196</p>	<p><b>Packaging Unit:</b> 1</p> <p><b>Model:</b> 16K 130 16K 160 16K 190 16S 109 16S 109 STR 16S 112 16S 112/1 16S 130 16S 130/1 16S 150 16S 151 16S 151 MAN</p> <p>16S 160 16S 160/1 16S 160A 16S 1650 IVE 16S 1650 MAZ 16S 181 16S 190 16S 190/1 16S 190A 16S 190A/1 16S 220 16S 220A</p>



<p><b>T21095</b></p> 	<p><b>Description:</b> OIL SEAL RING (25X35X7/10)</p> <p><b>OEM No :</b> 0634 307 367</p> <p><b>EX / CROSS :</b></p>	<p><b>Packaging Unit:</b> 10</p> <p><b>Model:</b> 16K 130 16K 160 16K 190 16S 109 16S 109 STR 16S 112 16S 112/1 16S 130 16S 130/1 16S 150 16S 151 16S 151 DAF 16S 151 HIN 16S 151 KMZ 16S 151 MAN 16S 151 SNVI 16S 151IT DAF 16S 160 16S 160/1 16S 160A 16S 160A/1 16S 1650 IVE 16S 1650 MAZ 16S 181</p>
<p><b>T20859</b></p> 	<p><b>Description:</b> OIL SEAL RING (25X40X15)</p> <p><b>OEM No :</b> 0750 112 253</p> <p><b>EX / CROSS :</b> 0750 112 131 0501 324 292 0501 312 845 0501 312 712</p>	<p><b>Packaging Unit:</b> 5</p> <p><b>Model:</b> 12S 2130TD 12S 2131TD IT 12S 2133TD 12S 2330TD 12S 2331TD IT 12S 2333TD 12S 233TD IT 12S 2830TD 12S 2831TD IT 12S 2833TD 12S 283TD IT 16S 151 16S 151 DAF 16S 151 HIN 16S 151 HYU 16S 151 IVE 16S 151 KMZ 16S 151 MAN 16S 151 RVI 16S 151 SNVI 16S 151IT DAF 16S 151PTO HIN 16S 1620TD 16S 1621TD IT</p>
<p><b>T21945</b></p> 	<p><b>Description:</b> OIL SEAL RING (30X37X4)</p> <p><b>OEM No :</b> 0750 111 575</p> <p><b>EX / CROSS :</b> 0501 312 738</p>	<p><b>Packaging Unit:</b> 4</p> <p><b>Model:</b> 16S 151 16S 151 HIN 16S 151 HYU 16S 151 MAN 16S 151 SNVI 16S 1685 16S 181 16S 181 IVE 16S 1920TD 16S 221 16S 221 IVE 16S 221 MB 16S 221 RVI 16S 221IT IVE 16S 2220TD 16S 2221TD IT 16S 2225TD 16S 2280TO 16S 2320TD 16S 2321TD IT 16S 2323TD 16S 2325TD 16S 232TD IT</p>
<p><b>T37750</b></p> 	<p><b>Description:</b> OIL SEAL RING (40X52X7/9)</p> <p><b>OEM No :</b> 0734 310 396</p> <p><b>EX / CROSS :</b> 0734 310 253</p>	<p><b>Packaging Unit:</b> 1</p> <p><b>Model:</b> S5 42 S5 42 SNVI S5 42 USA</p>
<p><b>T38660</b></p> 	<p><b>Description:</b> OIL SEAL RING (42X62X10/8)</p> <p><b>OEM No :</b> 0750 111 476</p> <p><b>EX / CROSS :</b> 0734 310 112 0734 310 304 0750 111 269</p>	<p><b>Packaging Unit:</b> 1</p> <p><b>Model:</b> 6S 700BO 6S 850 6S 850 DAF 6S 850 MAN 6S 890 AK5 35/2 S6 36 S6 36+GV36 S6 36/2</p>







<p><b>T38576</b></p>	<p><b>Description:</b> OIL SEAL RING (48X65X10)</p> <p><b>OEM No :</b> 0750 111 149</p> <p><b>EX / CROSS :</b> 0734 310 161</p>	<p><b>Packaging Unit:</b> 1</p> <p><b>Model:</b></p> <table> <tr><td>16S 109</td><td>6S 890</td></tr> <tr><td>6S 1000BD</td><td>8S 109</td></tr> <tr><td>6S 1000BO</td><td>8S 140</td></tr> <tr><td>6S 1200BD</td><td>9S 109</td></tr> <tr><td>6S 1200BO</td><td>9S 109 MAN</td></tr> <tr><td>6S 1200BO IKA</td><td>9S 109 SNVI</td></tr> <tr><td>6S 1200BO KMZ</td><td>9S 75</td></tr> <tr><td>6S 1200TD</td><td>S5 42</td></tr> <tr><td>6S 1200TO</td><td>S6 36</td></tr> <tr><td>6S 1205TD</td><td>S6 36/2</td></tr> <tr><td>6S 150C</td><td>S6 66</td></tr> <tr><td>6S 850</td><td>S6 66+GV66</td></tr> </table>	16S 109	6S 890	6S 1000BD	8S 109	6S 1000BO	8S 140	6S 1200BD	9S 109	6S 1200BO	9S 109 MAN	6S 1200BO IKA	9S 109 SNVI	6S 1200BO KMZ	9S 75	6S 1200TD	S5 42	6S 1200TO	S6 36	6S 1205TD	S6 36/2	6S 150C	S6 66	6S 850	S6 66+GV66
16S 109	6S 890																									
6S 1000BD	8S 109																									
6S 1000BO	8S 140																									
6S 1200BD	9S 109																									
6S 1200BO	9S 109 MAN																									
6S 1200BO IKA	9S 109 SNVI																									
6S 1200BO KMZ	9S 75																									
6S 1200TD	S5 42																									
6S 1200TO	S6 36																									
6S 1205TD	S6 36/2																									
6S 150C	S6 66																									
6S 850	S6 66+GV66																									
<p><b>T39290</b></p>	<p><b>Description:</b> OIL SEAL RING (48X65X10)</p> <p><b>OEM No :</b> 0734 300 087</p> <p><b>EX / CROSS :</b> 0634 300 543</p>	<p><b>Packaging Unit:</b> 1</p> <p><b>Model:</b></p>																								
<p><b>T69066</b></p>	<p><b>Description:</b> OIL SEAL RING (48X65X7)</p> <p><b>OEM No :</b> 0734 319 782</p> <p><b>EX / CROSS :</b></p>	<p><b>Packaging Unit:</b> 1</p> <p><b>Model:</b></p> <table> <tr><td>6AS 1000TO</td></tr> <tr><td>6AS 1005TO</td></tr> <tr><td>6AS 1110BO</td></tr> <tr><td>6AS 700TO</td></tr> <tr><td>6AS 800TO</td></tr> <tr><td>6AS 805TO</td></tr> <tr><td>6S 1000TO</td></tr> <tr><td>6S 1005TO</td></tr> <tr><td>6S 1010BO</td></tr> <tr><td>6S 800TO</td></tr> <tr><td>AS Tronic</td></tr> </table>	6AS 1000TO	6AS 1005TO	6AS 1110BO	6AS 700TO	6AS 800TO	6AS 805TO	6S 1000TO	6S 1005TO	6S 1010BO	6S 800TO	AS Tronic													
6AS 1000TO																										
6AS 1005TO																										
6AS 1110BO																										
6AS 700TO																										
6AS 800TO																										
6AS 805TO																										
6S 1000TO																										
6S 1005TO																										
6S 1010BO																										
6S 800TO																										
AS Tronic																										
<p><b>T38688</b></p>	<p><b>Description:</b> OIL SEAL RING (48X65X8/10)</p> <p><b>OEM No :</b> 0734 310 397</p> <p><b>EX / CROSS :</b></p>	<p><b>Packaging Unit:</b> 1</p> <p><b>Model:</b></p> <table> <tr><td>5S 600BO</td></tr> <tr><td>S5 42</td></tr> <tr><td>S5 42 KAVZ</td></tr> <tr><td>S5 42 KMZ</td></tr> <tr><td>S5 42 MAZ</td></tr> </table>	5S 600BO	S5 42	S5 42 KAVZ	S5 42 KMZ	S5 42 MAZ																			
5S 600BO																										
S5 42																										
S5 42 KAVZ																										
S5 42 KMZ																										
S5 42 MAZ																										
<p><b>T21126</b></p>	<p><b>Description:</b> OIL SEAL RING (48X69X10)</p> <p><b>OEM No :</b> 0734 310 108</p> <p><b>EX / CROSS :</b></p>	<p><b>Packaging Unit:</b> 1</p> <p><b>Model:</b></p> <table> <tr><td>AK6 65</td><td>S6 80/1</td></tr> <tr><td>AK6 65+GV80</td><td>S6 80/1+GV80</td></tr> <tr><td>AK6 80</td><td>S6 90</td></tr> <tr><td>AK6 80+GV80</td><td>S6 90 SETRA</td></tr> <tr><td>AK6 90</td><td>S6 90+GV90</td></tr> <tr><td>AK6 90+GV90</td><td>S6 90+GV90 SNVI</td></tr> <tr><td>S5 680</td><td>S6 90/1</td></tr> <tr><td>S5 680 SSO</td><td>S6 90/1+GV90</td></tr> <tr><td>S6 65</td><td></td></tr> <tr><td>S6 65+GV80</td><td></td></tr> <tr><td>S6 680</td><td></td></tr> <tr><td>S6 80+GV80</td><td></td></tr> </table>	AK6 65	S6 80/1	AK6 65+GV80	S6 80/1+GV80	AK6 80	S6 90	AK6 80+GV80	S6 90 SETRA	AK6 90	S6 90+GV90	AK6 90+GV90	S6 90+GV90 SNVI	S5 680	S6 90/1	S5 680 SSO	S6 90/1+GV90	S6 65		S6 65+GV80		S6 680		S6 80+GV80	
AK6 65	S6 80/1																									
AK6 65+GV80	S6 80/1+GV80																									
AK6 80	S6 90																									
AK6 80+GV80	S6 90 SETRA																									
AK6 90	S6 90+GV90																									
AK6 90+GV90	S6 90+GV90 SNVI																									
S5 680	S6 90/1																									
S5 680 SSO	S6 90/1+GV90																									
S6 65																										
S6 65+GV80																										
S6 680																										
S6 80+GV80																										







<p><b>T21759</b></p>	<p><b>Description:</b> OIL SEAL RING (48X75X8)</p> <p><b>OEM No :</b> 0750 111 002</p> <p><b>EX / CROSS :</b> 0734 310 110</p>	<p><b>Packaging Unit:</b> 1</p> <p><b>Model:</b> 16K 130 16K 160 16S 112 16S 112/1 16S 130 16S 130/1 16S 160 16S 160/1 16S 1650 16S 190 16S 190/1 16S 190A</p> <p>4S 150GP 5K 110GP 5K 110GP+GV90 5K 90GP 5K 91GP 5S 110GP 5S 110GP+GV90 5S 111GP 5S 111GP+GV90 5S 111GPA 5S 90GP 5S 92GP</p>
<p><b>T38681</b></p>	<p><b>Description:</b> OIL SEAL RING (50X100X7,5)</p> <p><b>OEM No :</b> 0734 307 287</p> <p><b>EX / CROSS :</b></p>	<p><b>Packaging Unit:</b> 1</p> <p><b>Model:</b> 16S 109 8S 109 8S 180 8S 2100BD 8S 2100BO 8S 2101BD IT 8S 2101BO IT 9S 109 9S 1110TD 9S 1110TO 9S 1111TD IT 9S 1111TO IT</p> <p>9S 1115TD 9S 1115TO 9S 1310TO 9S 1310TO KMZ 9S 1311TO IT 9S 1315TO</p>
<p><b>T54606</b></p>	<p><b>Description:</b> OIL SEAL RING (50X65X8)</p> <p><b>OEM No :</b> 0750 111 159</p> <p><b>EX / CROSS :</b> 0734 319 221 0734 319 609 0750 111 424</p>	<p><b>Packaging Unit:</b> 1</p> <p><b>Model:</b> S5 42 S5 47</p>
<p><b>T37898</b></p>	<p><b>Description:</b> OIL SEAL RING (50X65X8)</p> <p><b>OEM No :</b> 0734 319 652</p> <p><b>EX / CROSS :</b></p>	<p><b>Packaging Unit:</b> 1</p> <p><b>Model:</b> 5S 600BO S5 42 S5 42 KAVZ S5 42 KMZ S5 42 MAZ S5 42 SNVI S5 42 USA</p>
<p><b>T21004</b></p>	<p><b>Description:</b> OIL SEAL RING (52X68X8)</p> <p><b>OEM No :</b> 0734 310 104</p> <p><b>EX / CROSS :</b></p>	<p><b>Packaging Unit:</b> 1</p> <p><b>Model:</b> 16S 151 16S 151 MAN 16S 181 16S 221 16S 251 6S 150C 8S 180 8S 180 ENASA 8S 2100 8S 2100BD 8S 2100BO 8S 2101BD IT</p> <p>8S 2101BO IT 8S 221 9S 1110TD 9S 1110TO 9S 1115TD 9S 1310TO 9S 1310TO KMZ 9S 1315TO Ecosplit III</p>





<p><b>T38862</b></p> 	<p><b>Description:</b> OIL SEAL RING (52X72X8)</p> <p><b>OEM No :</b> 0734 319 514</p> <p><b>EX / CROSS :</b></p>	<p><b>Packaging Unit:</b> 1</p> <p><b>Model:</b> 16S 151 16S 181 16S 1822TO 16S 1922TD 16S 221 16S 2222TD 16S 2222TO 16S 2322TD 16S 2522TO Ecosplit III</p>
<p><b>T21798</b></p> 	<p><b>Description:</b> OIL SEAL RING (53X63X16,2)</p> <p><b>OEM No :</b> 0750 112 089</p> <p><b>EX / CROSS :</b> 0634 307 825 0734 317 025</p>	<p><b>Packaging Unit:</b> 1</p> <p><b>Model:</b> 16K 130 16K 160 16K 190 16S 109 16S 109 STR 16S 112 16S 112/1 16S 130 16S 130/1 16S 150 16S 160 16S 160/1 16S 160A 16S 160A/1 16S 1650 MAZ 16S 190 16S 190/1 16S 190A 16S 190A/1 16S 200 16S 220 16S 220A 8S 190</p>
<p><b>T22059</b></p> 	<p><b>Description:</b> OIL SEAL RING (55X63X9,4)</p> <p><b>OEM No :</b> 0750 112 177</p> <p><b>EX / CROSS :</b> 0750 112 117</p>	<p><b>Packaging Unit:</b> 10</p> <p><b>Model:</b> 16S 151 16S 151 DAF 16S 151 HIN 16S 151 HYU 16S 151 IVE 16S 151 KMZ 16S 151 MAN 16S 151 RVI 16S 151 SNVI 16S 151IT DAF 16S 151PTO HIN 16S 1620TD 16S 1621TD IT 16S 1625TD 16S 162TD IT 16S 1685 16S 181 16S 181 IVE 16S 181 MAN 16S 181 RVI 16S 181IT DAF 16S 182 16S 1820TO 16S 1820TO KMZ</p>
<p><b>T80286</b></p> 	<p><b>Description:</b> OIL SEAL RING (55X70X8)</p> <p><b>OEM No :</b> 0634 349 645</p> <p><b>EX / CROSS :</b></p>	<p><b>Packaging Unit:</b> 1</p> <p><b>Model:</b> 12AS 1210TO 12AS 1220TD 12AS 1420TD 12AS 1420TO 12AS 1620TO 9S 1110TD 9S 1110TO 9S 1111TD IT 9S 1111TO IT 9S 1115TO 9S 1310TO 9S 1311TO IT 9S 1315TO AS Tronic</p>
<p><b>T37694</b></p> 	<p><b>Description:</b> OIL SEAL RING (55X70X8)</p> <p><b>OEM No :</b> 0734 319 847</p> <p><b>EX / CROSS :</b> 0750 111 348</p>	<p><b>Packaging Unit:</b> 1</p> <p><b>Model:</b> 12AS 2302</p>



<p><b>T75437</b></p> 	<p><b>Description:</b> OIL SEAL RING (55X72X10)</p> <p><b>OEM No :</b> 0734 310 230</p> <p><b>EX / CROSS :</b></p>	<p><b>Packaging Unit:</b> 1</p> <p><b>Model:</b> 16S 109 6S 150C 8S 109 8S 140 9S 109</p>
<p><b>T37877</b></p> 	<p><b>Description:</b> OIL SEAL RING (55X72X8)</p> <p><b>OEM No :</b> 0734 319 559</p> <p><b>EX / CROSS :</b> 0634 300 128 0734 310 142 0750 111 040</p>	<p><b>Packaging Unit:</b> 1</p> <p><b>Model:</b> 16S 112 16S 130 16S 150 16S 160 16S 1625TD 16S 1831TO IT 16S 1835TO 16S 190 16S 1931TD IT 16S 1935TD 16S 200 16S 220 16S 2235TD 16S 2235TO 16S 2535TO 6AS 1005TO 6S 1005TO 6S 850 DAF 6S 850 MAN 8S 221 AS Tronic Ecosplit III Ecosplit IV - 16 speed</p>
<p><b>T54637</b></p> 	<p><b>Description:</b> OIL SEAL RING (55X75X10)</p> <p><b>OEM No :</b> 0734 300 094</p> <p><b>EX / CROSS :</b></p>	<p><b>Packaging Unit:</b> 1</p> <p><b>Model:</b></p>
<p><b>T20838</b></p> 	<p><b>Description:</b> OIL SEAL RING (55X75X8)</p> <p><b>OEM No :</b> 0768 800 253</p> <p><b>EX / CROSS :</b> 0734 310 387 0734 310 386 0734 310 111 0730 162 753</p>	<p><b>Packaging Unit:</b> 5</p> <p><b>Model:</b> 16S 1300 16S 151 MAN 16S 1600 16S 1650 IVE 16S 1900 8S 1350 KMZ S6 1550</p>
<p><b>T56534</b></p> 	<p><b>Description:</b> OIL SEAL RING (55X78X8)</p> <p><b>OEM No :</b> 0734 310 435</p> <p><b>EX / CROSS :</b> 0768 800 301</p>	<p><b>Packaging Unit:</b> 1</p> <p><b>Model:</b> 12S 2130TD 12S 2131TD IT 12S 2133TD 12S 2330TD 12S 2331TD IT 12S 2333TD 12S 2333TD IT 12S 2830TD 12S 2831TD IT 12S 2833TD 12S 2833TD IT 12S 2837TD 16S 1621TD IT 16S 1625TD 16S 162TD IT 16S 1630TD 16S 1631TD IT 16S 1635TD 16S 1635TD IT 16S 163TD IT 16S 1820TO 16S 1821TO IT 16S 182TO IT 16S 1830TO 16S 1831TO IT</p>



<p><b>T37763</b></p> 	<p><b>Description:</b> OIL SEAL RING (60X74X10)</p> <p><b>OEM No :</b> 0750 111 469</p> <p><b>EX / CROSS :</b> 0734 319 047 0750 111 268</p>	<p><b>Packaging Unit:</b> 1</p> <p><b>Model:</b> 5S 400V 6AS 300VD 6AS 320VD 6AS 380VO 6S 300 6S 700BO 6S 700BO KAVZ 6S 850 DAF 6S 850 MAN AK5 35/2 AS Tronic S5 35/2</p> <p>S6 36 S6 36+GV36</p>
<p><b>T50627</b></p> 	<p><b>Description:</b> OIL SEAL RING (60X85X12)</p> <p><b>OEM No :</b> 0734 310 122</p> <p><b>EX / CROSS :</b></p>	<p><b>Packaging Unit:</b> 1</p> <p><b>Model:</b> 4S 120GP 5K 110GPA 5K 110GPA+GV90 5K 90GPA 5K 91GPA 5S 110GPA 5S 110GPA+GV90 5S 111GP 5S 111GP+GV90 5S 111GPA 5S 90GPA AK6 65</p> <p>AK6 80 AK6 90 S6 65 S6 90</p>
<p><b>T20699</b></p> 	<p><b>Description:</b> OIL SEAL RING (79X105,1X5,3)</p> <p><b>OEM No :</b> 0501 314 108</p> <p><b>EX / CROSS :</b></p>	<p><b>Packaging Unit:</b> 5</p> <p><b>Model:</b> 8S 180 8S 180 ENASA 8S 2100BD 8S 2100BO 8S 2101BD IT 8S 2101BO IT 9S 1110TD 9S 1110TO 9S 1111TD IT 9S 1111TO IT 9S 1115TD 9S 1115TO</p> <p>9S 1310TO 9S 1310TO KMZ 9S 1311TO IT 9S 1315TO</p>
<p><b>T38575</b></p> 	<p><b>Description:</b> OIL SEAL RING (80X100X10)</p> <p><b>OEM No :</b> 0734 319 687</p> <p><b>EX / CROSS :</b> 0734 319 440 0750 111 334</p>	<p><b>Packaging Unit:</b> 1</p> <p><b>Model:</b> G100-12 G4/110-6/9,0 G4/65-6/9,0 G4/65-7/11,0 G4/95-6/9,0 G4/95-7/11,0 GO170-6/8,2-1,0 GO190-6/8,2-1,0 GO230-6/6,5-0,8 GO4/105-6/7,18 GO4/110-5/5,1 GO4/120-6/7,18</p> <p>GO4/130-6/7,18 GO4/160-6/7,18 GO4/160-6/8,2 GO4/95-5/5,1 GV4/110-6/9,0 GV4/65-6/9,0 GV4/95-6/9,0 HD 4/02 DG-10 HD 4/02 DG-10 BRAZIL HD 4/02 GD-10 HD 4/021 GS-10 BRAZIL HD 4/21 DG-10</p>
<p><b>T21159</b></p> 	<p><b>Description:</b> OIL SEAL RING (85X105X10)</p> <p><b>OEM No :</b> 0750 111 004</p> <p><b>EX / CROSS :</b> 0734 310 109</p>	<p><b>Packaging Unit:</b> 1</p> <p><b>Model:</b> 5K 90GP 5K 91GP 5S 111GP 5S 111GP+GV90 5S 111GPA 5S 90GP 5S 92GP AK6 80 AK6 80+GV80 AK6 90 AK6 90+GV90 S6 1550</p> <p>S6 80 S6 80+GV80 S6 80/1 S6 80/1+GV80 S6 90 S6 90 SETRA S6 90+GV90 S6 90+GV90 SNVI S6 90/1 S6 90/1+GV90</p>

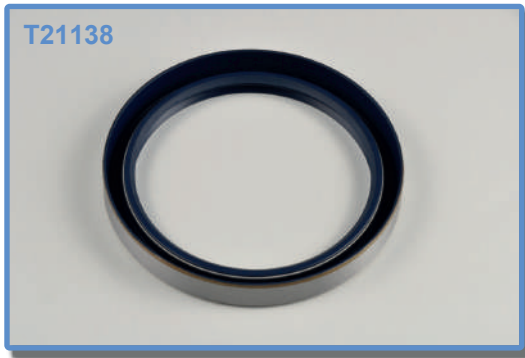

**T21138**

**Description:**

OIL SEAL RING (85X105X12)

**Packaging Unit:** 1

**OEM No :**

0750 110 074

**Model:**

5K 90GP S6 80+GV80  
5K 91GP S6 80/1  
5S 111GP S6 80/1+GV80  
5S 111GP+GV90 S6 90  
5S 111GPA S6 90+GV90  
5S 90GP S6 90/1  
5S 92GP S6 90/1+GV90  
AK6 80  
AK6 80+GV80  
AK6 90  
AK6 90+GV90  
S6 80

**EX / CROSS :**

0634 300 712

0734 300 093



**T37860**

**Description:**

OIL SEAL RING (95X115X10)

**Packaging Unit:** 1

**OEM No :**

0734 319 439

**Model:**

16S 109  
16S 109 STR  
6S 150C  
8S 109  
8S 140  
8S 180  
9S 109  
9S 109 MAN  
9S 109 SNVI

**EX / CROSS :**

0734 319 283

0750 111 081

0750 111 317



**T19433**

**Description:**

OIL SEAL RING KIT

**Packaging Unit:** 1

**OEM No :**

1315 298 003

**Model:**

16S 151  
16S 151 KMZ  
16S 151 MAN  
16S 181  
16S 221  
16S 251  
Ecosplit III

**EX / CROSS :**



**T19427**

**Description:**

OIL SEAL RING KIT

**Packaging Unit:** 1

**OEM No :**

1315 298 002

**Model:**

16S 151  
16S 151 DAF  
16S 151 HYU  
16S 151 KMZ  
16S 151 MAN  
16S 151 RVI  
16S 151 SNVI  
16S 181  
16S 221  
16S 2280TO  
16S 251  
Ecosplit III

**EX / CROSS :**



**T80289**

**Description:**

OIL SEAL RING KIT

**Packaging Unit:** 1



**OEM No :**

1290 298 920

**Model:**





S6 36  
S6 36+GV36

**EX / CROSS :**





<p><b>T20221</b></p> 	<p><b>Description:</b> OIL SEAL RING KIT</p> <p><b>OEM No :</b> 1268 298 903</p> <p><b>EX / CROSS :</b></p>	<p><b>Packaging Unit:</b> 1</p> <p><b>Model:</b> AK6 90 AK6 90+GV90 S6 90</p>
<p><b>T61735</b></p> 	<p><b>Description:</b> OIL SEAL RING KIT</p> <p><b>OEM No :</b> 1312 298 901</p> <p><b>EX / CROSS :</b></p>	<p><b>Packaging Unit:</b> 1</p> <p><b>Model:</b> 16S 150 16S 220</p>
<p><b>T51387</b></p> 	<p><b>Description:</b> OIL SEALS KIT</p> <p><b>OEM No :</b> 1297 298 800</p> <p><b>EX / CROSS :</b></p>	<p><b>Packaging Unit:</b> 1</p> <p><b>Model:</b> 16S 1650</p>
<p><b>T76143</b></p> 	<p><b>Description:</b> OIL SEALS RING KIT</p> <p><b>OEM No :</b> 1325 298 010</p> <p><b>EX / CROSS :</b></p>	<p><b>Packaging Unit:</b> 1</p> <p><b>Model:</b> 12S 2130TD 12S 2131TD IT 12S 2133TD 12S 2330TD 12S 2331TD IT 12S 2333TD 16S 1620TD 16S 1621TD IT 16S 1631TD IT 16S 1830TO 16S 1831TO IT 16S 1833TO 16S 1930TD 16S 1931TD IT 16S 1933TD 16S 1935TD 16S 2220TD 16S 2220TO 16S 2221TD IT 16S 2221TO IT 16S 2230TD 16S 2230TO 16S 2231TD IT 16S 2231TO IT</p>
<p><b>T93807</b></p> 	<p><b>Description:</b> OIL SEALS RING KIT</p> <p><b>OEM No :</b> 8098 633 003</p> <p><b>EX / CROSS :</b> 8098 633 014 8098 633 001</p>	<p><b>Packaging Unit:</b> 1</p> <p><b>Model:</b></p>

<p><b>T19997</b></p> 	<p><b>Description:</b> OIL TUBE</p> <p><b>OEM No :</b> 1312 304 150</p> <p><b>EX / CROSS :</b> 1312 304 097</p>	<p><b>Packaging Unit:</b> 1</p> <p><b>Model:</b></p> <table border="0"> <tr><td>12S 2130TD</td><td>16S 150</td></tr> <tr><td>12S 2131TD IT</td><td>16S 151</td></tr> <tr><td>12S 2133TD</td><td>16S 151 DAF</td></tr> <tr><td>12S 2330TD</td><td>16S 151 HIN</td></tr> <tr><td>12S 2331TD IT</td><td>16S 151 HYU</td></tr> <tr><td>12S 2333TD</td><td>16S 151 IVE</td></tr> <tr><td>12S 2333TD IT</td><td>16S 151 KMZ</td></tr> <tr><td>12S 2830TD</td><td>16S 151 MAN</td></tr> <tr><td>12S 2831TD IT</td><td>16S 151 RVI</td></tr> <tr><td>12S 2833TD</td><td>16S 151 SNVI</td></tr> <tr><td>12S 2833TD IT</td><td>16S 151IT DAF</td></tr> <tr><td>16S 109 STR</td><td>16S 151PTO HIN</td></tr> </table>	12S 2130TD	16S 150	12S 2131TD IT	16S 151	12S 2133TD	16S 151 DAF	12S 2330TD	16S 151 HIN	12S 2331TD IT	16S 151 HYU	12S 2333TD	16S 151 IVE	12S 2333TD IT	16S 151 KMZ	12S 2830TD	16S 151 MAN	12S 2831TD IT	16S 151 RVI	12S 2833TD	16S 151 SNVI	12S 2833TD IT	16S 151IT DAF	16S 109 STR	16S 151PTO HIN
12S 2130TD	16S 150																									
12S 2131TD IT	16S 151																									
12S 2133TD	16S 151 DAF																									
12S 2330TD	16S 151 HIN																									
12S 2331TD IT	16S 151 HYU																									
12S 2333TD	16S 151 IVE																									
12S 2333TD IT	16S 151 KMZ																									
12S 2830TD	16S 151 MAN																									
12S 2831TD IT	16S 151 RVI																									
12S 2833TD	16S 151 SNVI																									
12S 2833TD IT	16S 151IT DAF																									
16S 109 STR	16S 151PTO HIN																									
<p><b>T20709</b></p> 	<p><b>Description:</b> OIL TUBE</p> <p><b>OEM No :</b> 1304 302 440</p> <p><b>EX / CROSS :</b> 1304 302 364</p>	<p><b>Packaging Unit:</b> 1</p> <p><b>Model:</b></p> <table border="0"> <tr><td>16S 109</td><td>9S 109 MAN</td></tr> <tr><td>16S 109 STR</td><td>9S 109 SNVI</td></tr> <tr><td>6S 150C</td><td>9S 1110TD</td></tr> <tr><td>8S 109</td><td>9S 1110TO</td></tr> <tr><td>8S 140</td><td>9S 1111TD IT</td></tr> <tr><td>8S 180</td><td>9S 1111TO IT</td></tr> <tr><td>8S 180 ENASA</td><td>9S 1115TD</td></tr> <tr><td>8S 2100BD</td><td>9S 1115TO</td></tr> <tr><td>8S 2100BO</td><td>9S 1310TO</td></tr> <tr><td>8S 2101BD IT</td><td>9S 1310TO KMZ</td></tr> <tr><td>8S 2101BO IT</td><td>9S 1311TO IT</td></tr> <tr><td>9S 109</td><td>9S 1315TO</td></tr> </table>	16S 109	9S 109 MAN	16S 109 STR	9S 109 SNVI	6S 150C	9S 1110TD	8S 109	9S 1110TO	8S 140	9S 1111TD IT	8S 180	9S 1111TO IT	8S 180 ENASA	9S 1115TD	8S 2100BD	9S 1115TO	8S 2100BO	9S 1310TO	8S 2101BD IT	9S 1310TO KMZ	8S 2101BO IT	9S 1311TO IT	9S 109	9S 1315TO
16S 109	9S 109 MAN																									
16S 109 STR	9S 109 SNVI																									
6S 150C	9S 1110TD																									
8S 109	9S 1110TO																									
8S 140	9S 1111TD IT																									
8S 180	9S 1111TO IT																									
8S 180 ENASA	9S 1115TD																									
8S 2100BD	9S 1115TO																									
8S 2100BO	9S 1310TO																									
8S 2101BD IT	9S 1310TO KMZ																									
8S 2101BO IT	9S 1311TO IT																									
9S 109	9S 1315TO																									
<p><b>T20946</b></p> 	<p><b>Description:</b> OIL TUBE</p> <p><b>OEM No :</b> 1324 304 014</p> <p><b>EX / CROSS :</b></p>	<p><b>Packaging Unit:</b> 5</p> <p><b>Model:</b></p> <table border="0"> <tr><td>16S 109</td><td>9S 1110TO</td></tr> <tr><td>6S 150C</td><td>9S 1111TD IT</td></tr> <tr><td>8S 109</td><td>9S 1111TO IT</td></tr> <tr><td>8S 140</td><td>9S 1115TD</td></tr> <tr><td>8S 180</td><td>9S 1115TO</td></tr> <tr><td>8S 2100</td><td>9S 1310TO</td></tr> <tr><td>8S 2100BD</td><td>9S 1310TO KMZ</td></tr> <tr><td>8S 2100BO</td><td>9S 1311TO IT</td></tr> <tr><td>8S 2101BD IT</td><td>9S 1315TO</td></tr> <tr><td>8S 2101BO IT</td><td></td></tr> <tr><td>9S 109</td><td></td></tr> <tr><td>9S 1110TD</td><td></td></tr> </table>	16S 109	9S 1110TO	6S 150C	9S 1111TD IT	8S 109	9S 1111TO IT	8S 140	9S 1115TD	8S 180	9S 1115TO	8S 2100	9S 1310TO	8S 2100BD	9S 1310TO KMZ	8S 2100BO	9S 1311TO IT	8S 2101BD IT	9S 1315TO	8S 2101BO IT		9S 109		9S 1110TD	
16S 109	9S 1110TO																									
6S 150C	9S 1111TD IT																									
8S 109	9S 1111TO IT																									
8S 140	9S 1115TD																									
8S 180	9S 1115TO																									
8S 2100	9S 1310TO																									
8S 2100BD	9S 1310TO KMZ																									
8S 2100BO	9S 1311TO IT																									
8S 2101BD IT	9S 1315TO																									
8S 2101BO IT																										
9S 109																										
9S 1110TD																										
<p><b>T53677</b></p> 	<p><b>Description:</b> OIL TUBE</p> <p><b>OEM No :</b> 0730 061 842</p> <p><b>EX / CROSS :</b></p>	<p><b>Packaging Unit:</b> 1</p> <p><b>Model:</b></p> <table border="0"> <tr><td>16K 130</td><td>16S 190/1</td></tr> <tr><td>16K 160</td><td>16S 190A</td></tr> <tr><td>16K 190</td><td>16S 190A/1</td></tr> <tr><td>16S 112</td><td>16S 200</td></tr> <tr><td>16S 112/1</td><td>4S 150GP</td></tr> <tr><td>16S 130</td><td>4S 150GP+400</td></tr> <tr><td>16S 130/1</td><td>5K 110GP</td></tr> <tr><td>16S 160</td><td>5K 110GP+GV90</td></tr> <tr><td>16S 160/1</td><td>5K 110GPA</td></tr> <tr><td>16S 160A</td><td>5S 110GP</td></tr> <tr><td>16S 160A/1</td><td>5S 110GP+GV90</td></tr> <tr><td>16S 190</td><td>5S 110GPA</td></tr> </table>	16K 130	16S 190/1	16K 160	16S 190A	16K 190	16S 190A/1	16S 112	16S 200	16S 112/1	4S 150GP	16S 130	4S 150GP+400	16S 130/1	5K 110GP	16S 160	5K 110GP+GV90	16S 160/1	5K 110GPA	16S 160A	5S 110GP	16S 160A/1	5S 110GP+GV90	16S 190	5S 110GPA
16K 130	16S 190/1																									
16K 160	16S 190A																									
16K 190	16S 190A/1																									
16S 112	16S 200																									
16S 112/1	4S 150GP																									
16S 130	4S 150GP+400																									
16S 130/1	5K 110GP																									
16S 160	5K 110GP+GV90																									
16S 160/1	5K 110GPA																									
16S 160A	5S 110GP																									
16S 160A/1	5S 110GP+GV90																									
16S 190	5S 110GPA																									
<p><b>T60592</b></p> 	<p><b>Description:</b> OIL TUBE</p> <p><b>OEM No :</b> 1314 304 097</p> <p><b>EX / CROSS :</b></p>	<p><b>Packaging Unit:</b> 1</p> <p><b>Model:</b></p> <table border="0"> <tr><td>10AS 2010B IT</td><td>12 TX 1415 TD IT (1372 001 026)</td></tr> <tr><td>10AS 2300BO</td><td>12 TX 1610 TO IT (1372 002 025)</td></tr> <tr><td>10AS 2310B</td><td>12 TX 1610 TO IT (1372 002 045)</td></tr> <tr><td>10AS 2310B IT</td><td>12 TX 1611 BO IT (1372 044 006)</td></tr> <tr><td>10AS 2700BO</td><td>12 TX 1611 BO IT (1372 044 033)</td></tr> <tr><td>12 TX 1410 TD IT (1372 001 023)</td><td>12 TX 1611 BO IT (1372 044 050)</td></tr> <tr><td>12 TX 1410 TD IT (1372 001 030)</td><td>12 TX 1611 BO IT (1372 044 051)</td></tr> <tr><td>12 TX 1410 TO (1372 002 019)</td><td></td></tr> <tr><td>12 TX 1411 TD IT (1372 040 027)</td><td></td></tr> <tr><td>12 TX 1411 TD IT (1372 040 028)</td><td></td></tr> </table>	10AS 2010B IT	12 TX 1415 TD IT (1372 001 026)	10AS 2300BO	12 TX 1610 TO IT (1372 002 025)	10AS 2310B	12 TX 1610 TO IT (1372 002 045)	10AS 2310B IT	12 TX 1611 BO IT (1372 044 006)	10AS 2700BO	12 TX 1611 BO IT (1372 044 033)	12 TX 1410 TD IT (1372 001 023)	12 TX 1611 BO IT (1372 044 050)	12 TX 1410 TD IT (1372 001 030)	12 TX 1611 BO IT (1372 044 051)	12 TX 1410 TO (1372 002 019)		12 TX 1411 TD IT (1372 040 027)		12 TX 1411 TD IT (1372 040 028)					
10AS 2010B IT	12 TX 1415 TD IT (1372 001 026)																									
10AS 2300BO	12 TX 1610 TO IT (1372 002 025)																									
10AS 2310B	12 TX 1610 TO IT (1372 002 045)																									
10AS 2310B IT	12 TX 1611 BO IT (1372 044 006)																									
10AS 2700BO	12 TX 1611 BO IT (1372 044 033)																									
12 TX 1410 TD IT (1372 001 023)	12 TX 1611 BO IT (1372 044 050)																									
12 TX 1410 TD IT (1372 001 030)	12 TX 1611 BO IT (1372 044 051)																									
12 TX 1410 TO (1372 002 019)																										
12 TX 1411 TD IT (1372 040 027)																										
12 TX 1411 TD IT (1372 040 028)																										



<p><b>T62174</b></p> 	<p><b>Description:</b> OIL TUBE</p> <p><b>OEM No :</b> 1314 332 043</p> <p><b>EX / CROSS :</b></p>	<p><b>Packaging Unit:</b></p> <p><b>Model:</b></p> <table border="0"> <tr> <td>10AS 2010B IT</td> <td>12 TX 1415 TD IT (1372 001 026)</td> </tr> <tr> <td>10AS 2300BO</td> <td>12 TX 1610 TO IT (1372 002 025)</td> </tr> <tr> <td>10AS 2310B</td> <td>12 TX 1610 TO IT (1372 002 045)</td> </tr> <tr> <td>10AS 2310B IT</td> <td>12 TX 1611 BO IT (1372 044 006)</td> </tr> <tr> <td>10AS 2700BO</td> <td>12 TX 1611 BO IT (1372 044 033)</td> </tr> <tr> <td>12 TX 1410 TD IT (1372 001 023)</td> <td>12 TX 1611 BO IT (1372 044 050)</td> </tr> <tr> <td>12 TX 1410 TD IT (1372 001 030)</td> <td>12 TX 1611 BO IT (1372 044 050)</td> </tr> <tr> <td>12 TX 1410 TO (1372 002 019)</td> <td></td> </tr> <tr> <td>12 TX 1411 TD IT (1372 040 027)</td> <td></td> </tr> <tr> <td>12 TX 1411 TD IT (1372 040 027)</td> <td></td> </tr> </table>	10AS 2010B IT	12 TX 1415 TD IT (1372 001 026)	10AS 2300BO	12 TX 1610 TO IT (1372 002 025)	10AS 2310B	12 TX 1610 TO IT (1372 002 045)	10AS 2310B IT	12 TX 1611 BO IT (1372 044 006)	10AS 2700BO	12 TX 1611 BO IT (1372 044 033)	12 TX 1410 TD IT (1372 001 023)	12 TX 1611 BO IT (1372 044 050)	12 TX 1410 TD IT (1372 001 030)	12 TX 1611 BO IT (1372 044 050)	12 TX 1410 TO (1372 002 019)		12 TX 1411 TD IT (1372 040 027)		12 TX 1411 TD IT (1372 040 027)					
10AS 2010B IT	12 TX 1415 TD IT (1372 001 026)																									
10AS 2300BO	12 TX 1610 TO IT (1372 002 025)																									
10AS 2310B	12 TX 1610 TO IT (1372 002 045)																									
10AS 2310B IT	12 TX 1611 BO IT (1372 044 006)																									
10AS 2700BO	12 TX 1611 BO IT (1372 044 033)																									
12 TX 1410 TD IT (1372 001 023)	12 TX 1611 BO IT (1372 044 050)																									
12 TX 1410 TD IT (1372 001 030)	12 TX 1611 BO IT (1372 044 050)																									
12 TX 1410 TO (1372 002 019)																										
12 TX 1411 TD IT (1372 040 027)																										
12 TX 1411 TD IT (1372 040 027)																										
<p><b>T18533</b></p> 	<p><b>Description:</b> OIL TUBE (ZF ORIGINAL)</p> <p><b>OEM No :</b> 1354 302 019</p> <p><b>EX / CROSS :</b> 1312 202 017 1312 302 095 1315 302 196</p>	<p><b>Packaging Unit:</b> 1</p> <p><b>Model:</b></p> <table border="0"> <tr> <td>16S 151 DAF</td> <td>16S 181 RVI</td> </tr> <tr> <td>16S 151 HIN</td> <td>16S 181IT DAF</td> </tr> <tr> <td>16S 151 HYU</td> <td>16S 221 DAF</td> </tr> <tr> <td>16S 151 KMZ</td> <td>16S 221 IVE</td> </tr> <tr> <td>16S 151 MAN</td> <td>16S 221 MAN</td> </tr> <tr> <td>16S 151 RVI</td> <td>16S 221 MB</td> </tr> <tr> <td>16S 151 SNVI</td> <td>16S 221 RVI</td> </tr> <tr> <td>16S 151IT DAF</td> <td>16S 221IT IVE</td> </tr> <tr> <td>16S 151PTO HIN</td> <td>16S 221IT RVI</td> </tr> <tr> <td>16S 1685</td> <td>16S 2280TO</td> </tr> <tr> <td>16S 181 IVE</td> <td>16S 251 NIS</td> </tr> <tr> <td>16S 181 MAN</td> <td>16S 2520TO MAN</td> </tr> </table>	16S 151 DAF	16S 181 RVI	16S 151 HIN	16S 181IT DAF	16S 151 HYU	16S 221 DAF	16S 151 KMZ	16S 221 IVE	16S 151 MAN	16S 221 MAN	16S 151 RVI	16S 221 MB	16S 151 SNVI	16S 221 RVI	16S 151IT DAF	16S 221IT IVE	16S 151PTO HIN	16S 221IT RVI	16S 1685	16S 2280TO	16S 181 IVE	16S 251 NIS	16S 181 MAN	16S 2520TO MAN
16S 151 DAF	16S 181 RVI																									
16S 151 HIN	16S 181IT DAF																									
16S 151 HYU	16S 221 DAF																									
16S 151 KMZ	16S 221 IVE																									
16S 151 MAN	16S 221 MAN																									
16S 151 RVI	16S 221 MB																									
16S 151 SNVI	16S 221 RVI																									
16S 151IT DAF	16S 221IT IVE																									
16S 151PTO HIN	16S 221IT RVI																									
16S 1685	16S 2280TO																									
16S 181 IVE	16S 251 NIS																									
16S 181 MAN	16S 2520TO MAN																									
<p><b>T41955</b></p> 	<p><b>Description:</b> P.T.O. ASSEMBLY (NH 1C) PRESSURE SWITCH SLEEVE Z12</p> <p><b>OEM No :</b> 6090 012 002</p> <p><b>EX / CROSS :</b></p>	<p><b>Packaging Unit:</b> 1</p> <p><b>Model:</b></p>																								
<p><b>T60686</b></p> 	<p><b>Description:</b> P.T.O. ASSEMBLY (NH 1C) REED SWITCH SLEEVE Z12</p> <p><b>OEM No :</b> 6090 012 022</p> <p><b>EX / CROSS :</b> 6090 012 030</p>	<p><b>Packaging Unit:</b> 1</p> <p><b>Model:</b></p>																								
<p><b>T57538</b></p> 	<p><b>Description:</b> PIN</p> <p><b>OEM No :</b> 0731 208 242</p> <p><b>EX / CROSS :</b></p>	<p><b>Packaging Unit:</b> 1</p> <p><b>Model:</b></p> <table border="0"> <tr> <td>10AS 2010B IT</td> <td>12 TX 1415 TD IT (1372 001 026)</td> </tr> <tr> <td>10AS 2300BO</td> <td>12 TX 1610 TO IT (1372 002 025)</td> </tr> <tr> <td>10AS 2310B</td> <td>12 TX 1610 TO IT (1372 002 045)</td> </tr> <tr> <td>10AS 2310B IT</td> <td>12 TX 1611 BO IT (1372 044 006)</td> </tr> <tr> <td>10AS 2700BO</td> <td>12 TX 1611 BO IT (1372 044 033)</td> </tr> <tr> <td>12 TX 1410 TD IT (1372 001 023)</td> <td>12 TX 1611 BO IT (1372 044 050)</td> </tr> <tr> <td>12 TX 1410 TD IT (1372 001 030)</td> <td>12 TX 1611 BO IT (1372 044 050)</td> </tr> <tr> <td>12 TX 1410 TO (1372 002 019)</td> <td></td> </tr> <tr> <td>12 TX 1411 TD IT (1372 040 027)</td> <td></td> </tr> <tr> <td>12 TX 1411 TD IT (1372 040 027)</td> <td></td> </tr> </table>	10AS 2010B IT	12 TX 1415 TD IT (1372 001 026)	10AS 2300BO	12 TX 1610 TO IT (1372 002 025)	10AS 2310B	12 TX 1610 TO IT (1372 002 045)	10AS 2310B IT	12 TX 1611 BO IT (1372 044 006)	10AS 2700BO	12 TX 1611 BO IT (1372 044 033)	12 TX 1410 TD IT (1372 001 023)	12 TX 1611 BO IT (1372 044 050)	12 TX 1410 TD IT (1372 001 030)	12 TX 1611 BO IT (1372 044 050)	12 TX 1410 TO (1372 002 019)		12 TX 1411 TD IT (1372 040 027)		12 TX 1411 TD IT (1372 040 027)					
10AS 2010B IT	12 TX 1415 TD IT (1372 001 026)																									
10AS 2300BO	12 TX 1610 TO IT (1372 002 025)																									
10AS 2310B	12 TX 1610 TO IT (1372 002 045)																									
10AS 2310B IT	12 TX 1611 BO IT (1372 044 006)																									
10AS 2700BO	12 TX 1611 BO IT (1372 044 033)																									
12 TX 1410 TD IT (1372 001 023)	12 TX 1611 BO IT (1372 044 050)																									
12 TX 1410 TD IT (1372 001 030)	12 TX 1611 BO IT (1372 044 050)																									
12 TX 1410 TO (1372 002 019)																										
12 TX 1411 TD IT (1372 040 027)																										
12 TX 1411 TD IT (1372 040 027)																										







<p><b>T53730</b></p> 	<p><b>Description:</b> PIN</p> <p><b>OEM No :</b> 0735 470 007</p> <p><b>EX / CROSS :</b></p> <p><b>Model:</b> 5K 90GP 5K 90GPA 5K 91GP 5K 91GPA 5S 110GP 5S 110GP+GV90 5S 110GPA 5S 110GPA+GV90 5S 90GP 5S 90GPA 5S 92GP AK6 65</p>	<p><b>Packaging Unit:</b> 10</p> <p>AK6 65+GV80 AK6 80 AK6 80+GV80 AK6 90 AK6 90+GV90 S6 1550 S6 65 S6 65+GV80 S6 80 S6 80+GV80 S6 80/1 S6 80/1+GV80</p>
<p><b>T08929</b></p> 	<p><b>Description:</b> PIN</p> <p><b>OEM No :</b> 1252 306 077</p> <p><b>EX / CROSS :</b> 1252 306 012</p>	<p><b>Packaging Unit:</b> 2</p>
<p><b>T19116</b></p> 	<p><b>Description:</b> PIN</p> <p><b>OEM No :</b> 1295 307 243</p> <p><b>EX / CROSS :</b> 0731 208 033</p>	<p><b>Packaging Unit:</b> 5</p> <p>16S 1650 IVE 16S 1650 MAZ 16S 190 16S 190/1 16S 190A 16S 190A/1 16S 220 16S 220A 8S 1350 KMZ 8S 190 AK6 65 AK6 65+GV80</p>
<p><b>T76072</b></p> 	<p><b>Description:</b> PIN</p> <p><b>OEM No :</b> 1358 302 261</p> <p><b>EX / CROSS :</b></p>	<p><b>Packaging Unit:</b> 1</p> <p>12 TX 1410 TD IT (1372 001 023) 12 TX 1410 TD IT (1372 001 030) 12 TX 1410 TO (1372 002 019) 12 TX 1411 TD IT (1372 040 027) 12 TX 1411 TD IT (1372 040 028) 12 TX 1411 TD IT (1372 040 029) 12 TX 1411 TO IT (1372 041 017) 12 TX 1611 BO IT (1372 044 050) 12 TX 1611 BO IT (1372 044 051) 12 TX 1611 BO IT (1372 044 071) 12 TX 1611 BO IT (1372 044 075) 12 TX 1611 TO IT (1372 041 015) 12 TX 1611 TO IT (1372 041 016) 12 TX 1810 TD IT (1372 001 024)</p>
<p><b>T58490</b></p> 	<p><b>Description:</b> PISTON</p> <p><b>OEM No :</b> 0501 324 670</p> <p><b>EX / CROSS :</b></p>	<p><b>Packaging Unit:</b> 1</p> <p>12S 2130TD 12S 2131TD IT 12S 2133TD 12S 2330TD 12S 2331TD IT 12S 2333TD 12S 2333TD IT 12S 2831TD IT 12S 2833TD 12S 2833TD IT 16S 1620TD 16S 1621TD IT 16S 1625TD 16S 162TD IT 16S 1630TD 16S 1631TD IT 16S 1635TD 16S 163TD IT 16S 1685 16S 1820TO 16S 1821TO IT 16S 182TO IT 16S 1830TO 16S 1831TO IT</p>





<p><b>T80296</b></p> 	<p><b>Description:</b> PISTON</p> <p><b>OEM No :</b> 1315 334 041</p> <p><b>EX / CROSS :</b></p>	<p><b>Packaging Unit:</b> 1</p> <p><b>Model:</b> 16S 109 8S 109 8S 180 8S 2100 8S 2100BD 8S 2100BO 8S 2101BD IT 8S 2101BO IT 9S 109 9S 1110TD 9S 1110TO 9S 1111TD IT</p> <p>9S 1111TO IT 9S 1115TD 9S 1115TO 9S 1310TO 9S 1311TO IT 9S 1315TO</p>
<p><b>T08532</b></p> 	<p><b>Description:</b> PIVOT</p> <p><b>OEM No :</b> 1285 332 011</p> <p><b>EX / CROSS :</b></p>	<p><b>Packaging Unit:</b> 5</p> <p><b>Model:</b></p>
<p><b>T08919</b></p> 	<p><b>Description:</b> PIVOT</p> <p><b>OEM No :</b> 1269 332 036</p> <p><b>EX / CROSS :</b> 1269 332 025</p>	<p><b>Packaging Unit:</b> 5</p> <p><b>Model:</b></p>
<p><b>T15739</b></p> 	<p><b>Description:</b> PIVOT</p> <p><b>OEM No :</b> 1297 332 109</p> <p><b>EX / CROSS :</b> 1297 332 005</p>	<p><b>Packaging Unit:</b> 5</p> <p><b>Model:</b></p>
<p><b>T43981</b></p> 	<p><b>Description:</b> PIVOT</p> <p><b>OEM No :</b> 1316 332 140</p> <p><b>EX / CROSS :</b></p>	<p><b>Packaging Unit:</b> 5</p> <p><b>Model:</b> 12S 2330TD 12S 2331TD IT 12S 2333TD 12S 2333TD IT 12S 2831TD IT 12S 2833TD 12S 2833TD IT 16S 1685 16S 181 16S 221 16S 2220TD 16S 2221TD IT</p> <p>16S 2222TD 16S 2223TD 16S 2225TD 16S 2227TD IT 16S 2230TD 16S 2231TD IT 16S 2233TD 16S 2235TD 16S 2237TD IT 16S 2280TO 16S 2320TD 16S 2321TD IT</p>



<p><b>T10175</b></p> 	<p><b>Description:</b> PIVOT</p> <p><b>OEM No :</b> 1269 332 050</p> <p><b>EX / CROSS :</b></p>	<p><b>Packaging Unit:</b> 5</p> <p><b>Model:</b> 5K 110GPA 5K 110GPA+GV90 5S 110GPA 5S 110GPA+GV90 5S 111GPA</p>
<p><b>T20551</b></p> 	<p><b>Description:</b> PIVOT</p> <p><b>OEM No :</b> 1316 332 096</p> <p><b>EX / CROSS :</b> 1316 332 038</p>	<p><b>Packaging Unit:</b> 5</p> <p><b>Model:</b> 12S 2830TD 16S 181 16S 181IT DAF 16S 221 16S 221 DAF 16S 221 MAN 16S 221 VW 16S 221IT RVI 16S 2320TD 16S 2321TD IT 16S 2322TD 16S 2323TD 16S 2325TD 16S 2327TD IT 16S 2520TO 16S 2520TO MAN 16S 2521TO IT 16S 2522TO 16S 2523TO IT 16S 2525TO Ecosplit III</p>
<p><b>T20259</b></p> 	<p><b>Description:</b> PIVOT</p> <p><b>OEM No :</b> 1315 332 053</p> <p><b>EX / CROSS :</b> 1315 332 044</p>	<p><b>Packaging Unit:</b> 5</p> <p><b>Model:</b> 16S 181 16S 181 DAF 16S 181 HIN 16S 181 HYU 16S 181 IVE 16S 181 KMZ 16S 181 MAN 16S 181 RVI 16S 1820TD 16S 1820TO KMZ 16S 1821TO IT 16S 1822TO 16S 1823TO 16S 1825TO 16S 182TO IT</p>
<p><b>T43983</b></p> 	<p><b>Description:</b> PIVOT</p> <p><b>OEM No :</b> 1315 332 091</p> <p><b>EX / CROSS :</b></p>	<p><b>Packaging Unit:</b> 5</p> <p><b>Model:</b> 12S 2130TD 12S 2131TD IT 12S 2133TD 16S 181 16S 1820TD 16S 1821TD IT 16S 1825TD 16S 182TD IT 16S 1620TD 16S 1621TD IT 16S 1625TD 16S 162TD IT 16S 1630TD 16S 1631TD IT 16S 1635TD 16S 163TD IT 16S 181 16S 182 16S 1820TO 16S 1820TO RVI 16S 1821TO IT 16S 1822TO 16S 1823TO 16S 1825TO 16S 182TO IT 16S 1830TO 16S 1831TO IT 16S 1833TO</p>
<p><b>T57495</b></p> 	<p><b>Description:</b> PIVOT</p> <p><b>OEM No :</b> 1358 332 229</p> <p><b>EX / CROSS :</b> 1328 332 041</p>	<p><b>Packaging Unit:</b> 1</p> <p><b>Model:</b> 10AS 2010B IT 10AS 2300BO 10AS 2310B 10AS 2310B IT 10AS 2700BO 12AS 1601BO IT 12AS 1630TD 12AS 1631TD IT 12AS 1930TD 12AS 1930TO 12AS 1931TD IT 12AS 1931TO IT 12AS 1935TD 12AS 2000B IT 12AS 2000BO 12AS 2001BO IT 12AS 2130TD 12AS 2130TO 12AS 2131TD IT 12AS 2131TO IT 12AS 2140TD 12AS 2300B IT 12AS 2300BO 12AS 2301</p>



<p><b>T60303</b></p> 	<p><b>Description:</b> PIVOT</p> <p><b>OEM No :</b> 1304 332 111</p> <p><b>EX / CROSS :</b> 1304 332 019</p> <p><b>Model:</b> 16S 109 8S 109 8S 140 8S 180 8S 2100 8S 2100BD 8S 2100BO 8S 2101BD IT 8S 2101BO IT 9S 109</p>	<p><b>Packaging Unit:</b> 5</p>
<p><b>T22308</b></p> 	<p><b>Description:</b> PIVOT</p> <p><b>OEM No :</b> 1324 332 016</p> <p><b>EX / CROSS :</b> 1324 332 012</p> <p><b>Model:</b> 9S 1310TO 9S 1310TO KMZ</p>	<p><b>Packaging Unit:</b> 4</p>
<p><b>T08506</b></p> 	<p><b>Description:</b> PIVOT REVERSE</p> <p><b>OEM No :</b> 1269 305 003</p> <p><b>EX / CROSS :</b> 1240 305 005 1281 305 001</p> <p><b>Model:</b></p>	<p><b>Packaging Unit:</b> 1</p>
<p><b>T08582</b></p> 	<p><b>Description:</b> PIVOT REVERSE</p> <p><b>OEM No :</b> 1250 305 003</p> <p><b>EX / CROSS :</b></p> <p><b>Model:</b></p>	<p><b>Packaging Unit:</b> 1</p>
<p><b>T19961</b></p> 	<p><b>Description:</b> PLANETARY CARRIER EMPTY</p> <p><b>OEM No :</b> 1297 232 039</p> <p><b>EX / CROSS :</b> 1297 232 027 0091 232 022 0091 232 013</p> <p><b>Model:</b> 16K 160 16K 190 16S 160 16S 160/1 16S 1600 16S 190 16S 190/1 16S 1900 16S 200 8S 190</p>	<p><b>Packaging Unit:</b> 1</p>



**T08833**

**Description:**

PLANETARY CARRIER EMPTY

**Packaging Unit:** 1

**OEM No :**

1269 232 041

**Model:**

**EX / CROSS :**

1269 232 019



**T43980**

**Description:**

PLANETARY CARRIER EMPTY

**Packaging Unit:** 1

**OEM No :**

1316 232 039

**Model:**

12S 2330TD  
12S 2331TD IT  
12S 2333TD  
12S 2333TD IT  
12S 2831TD IT  
12S 2833TD  
12S 2833TD IT  
12S 2837TD IT  
16S 1685  
16S 181  
16S 221  
16S 2220TD  
16S 2221TD IT  
16S 2222TD  
16S 2223TD  
16S 2225TD  
16S 2227TD IT  
16S 2230TD  
16S 2231TD IT  
16S 2233TD  
16S 2235TD  
16S 2237TD IT  
16S 2280TO  
16S 2320TD  
16S 2321TD IT

**EX / CROSS :**



**T23645**

**Description:**

PLANETARY CARRIER EMPTY

**Packaging Unit:** 1

**OEM No :**

1324 232 004

**Model:**

9S 1110TD  
9S 1110TO  
9S 1115TD  
9S 1115TO  
9S 1310TO  
9S 1310TO KMZ  
9S 1315TO

**EX / CROSS :**



**T43982**

**Description:**

PLANETARY CARRIER EMPTY

**Packaging Unit:** 1

**OEM No :**

1315 232 027

**Model:**

12S 2130TD  
12S 2131TD IT  
12S 2133TD  
16S 151  
16S 1620TD  
16S 1621TD IT  
16S 1625TD  
16S 1627TD IT  
16S 1630TD  
16S 1631TD IT  
16S 1635TD  
16S 1637TD IT  
16S 181  
16S 182  
16S 1820TO  
16S 1820TO RVI  
16S 1821TO IT  
16S 1822TO  
16S 1823TO  
16S 1825TO  
16S 1827TO IT  
16S 1830TO  
16S 1831TO IT  
16S 1833TO

**EX / CROSS :**



**T57493**

**Description:**

PLANETARY CARRIER EMPTY

**Packaging Unit:** 1

**OEM No :**

1358 232 201

**Model:**

10AS 2010B IT  
10AS 2300BO  
10AS 2310B  
10AS 2310B IT  
10AS 2700BO  
12AS 1601BO IT  
12AS 1630TD  
12AS 1631TD IT  
12AS 1930TD  
12AS 1930TO  
12AS 1931TD IT  
12AS 1931TO IT  
12AS 1935TD  
12AS 2000B IT  
12AS 2000BO  
12AS 2001BO IT  
12AS 2130TD  
12AS 2130TO  
12AS 2131TD IT  
12AS 2131TO IT  
12AS 2140TD  
12AS 2300B IT  
12AS 2300BO  
12AS 2301

**EX / CROSS :**

0769 171 145

1328 232 011

1328 232 016

1328 232 010



**T08827**

**Description:**  
PLANETARY CARRIER EMPTY

**Packaging Unit:** 1

**OEM No :** 1285 232 003  
**Model:**

**EX / CROSS :**



**T20235**

**Description:**  
PLANETARY CARRIER EMPTY

**Packaging Unit:** 1

**OEM No :** 1315 232 017  
**Model:**

**EX / CROSS :**  
1315 232 016  
1315 232 013



**T20581**

**Description:**  
PLANETARY CARRIER EMPTY

**Packaging Unit:** 1

**OEM No :** 1316 232 019  
**Model:**  
12S 2830TD  
16S 181  
16S 181IT DAF  
16S 221  
16S 221 DAF  
16S 221 MAN  
16S 221 VW  
16S 221IT RVI  
16S 2320TD  
16S 2321TD IT  
16S 2322TD  
16S 2323TD

16S 2325TD  
16S 232TD IT  
16S 2520TO  
16S 2520TO MAN  
16S 2521TO IT  
16S 2522TO  
16S 2523TO IT  
16S 2525TO  
Ecosplit III

**EX / CROSS :**



**T22326**

**Description:**  
PLANETARY CARRIER HUB (114T.)

**Packaging Unit:** 1

**OEM No :** 1324 332 007  
**Model:**

**EX / CROSS :**

9S 1110TD  
9S 1110TO  
9S 1115TD  
9S 1115TO  
9S 1310TO  
9S 1310TO KMZ  
9S 1315TO



**T20268**

**Description:**  
PLANETARY CARRIER HUB (82T.)

**Packaging Unit:** 1

**OEM No :** 1316 332 130  
**Model:**

**EX / CROSS :**  
1316 332 103

16S 151 DAF  
16S 151 HIN  
16S 151 HYU  
16S 151 KMZ  
16S 151 MAN  
16S 151 RVI  
16S 181 IVE  
16S 181 MAN  
16S 181 RVI  
16S 181IT DAF  
16S 221 DAF  
16S 221 MAN

16S 221 VW  
16S 221IT RVI  
16S 2280TO  
16S 2520TO MAN  
8S 151 DAF



<p><b>T20043</b></p> 	<p><b>Description:</b> PLANETARY CARRIER HUB (83T.)</p> <p><b>Packaging Unit:</b> 1</p> <p><b>OEM No :</b> 1297 332 017</p> <p><b>Model:</b> 16K 160 16K 190 16S 160 16S 160/1 16S 1600 16S 160A 16S 160A/1 16S 190 16S 190/1 16S 1900 16S 190A 16S 200</p> <p><b>EX / CROSS :</b></p>
<p><b>T08836</b></p> 	<p><b>Description:</b> PLANETARY CARRIER HUB (85T.)</p> <p><b>Packaging Unit:</b> 1</p> <p><b>OEM No :</b> 1269 332 054</p> <p><b>Model:</b></p> <p><b>EX / CROSS :</b></p>
<p><b>T50171</b></p> 	<p><b>Description:</b> PLANETARY CARRIER HUB (86T.)</p> <p><b>Packaging Unit:</b> 1</p> <p><b>OEM No :</b> 1297 332 120</p> <p><b>Model:</b> 16S 190 16S 190/1 16S 220 16S 220A 16S 221 Ecosplit III</p> <p><b>EX / CROSS :</b></p>
<p><b>T53412</b></p> 	<p><b>Description:</b> PLANETARY CARRIER HUB (86T.)</p> <p><b>Packaging Unit:</b> 1</p> <p><b>OEM No :</b> 1297 332 035</p> <p><b>Model:</b> 16K 160 16K 190 16S 130 16S 130/1 16S 160 16S 160/1 16S 160A 16S 1650 16S 190 16S 190A 16S 190A/1</p> <p><b>EX / CROSS :</b></p>
<p><b>T74157</b></p> 	<p><b>Description:</b> PLANETARY CARRIER HUB (86T.)</p> <p><b>Packaging Unit:</b> 1</p> <p><b>OEM No :</b> 1304 332 060</p> <p><b>Model:</b> 16S 109 8S 140 9S 109</p> <p><b>EX / CROSS :</b></p>



**T73976**



**Description:**

PLANETARY CARRIER W/GEARS

**Packaging Unit: 1**

**OEM No :**

TAS73976

**Model:**

12 TX 1410 TD IT (1372 001 023)	12 TX 1611 BO IT (1372 044 050)
12 TX 1410 TD IT (1372 001 030)	12 TX 1611 BO IT (1372 044 051)
12 TX 1410 TO (1372 002 019)	12 TX 1611 BO IT (1372 044 071)
12 TX 1411 TD IT (1372 040 027)	12 TX 1611 BO IT (1372 044 075)
12 TX 1411 TD IT (1372 040 028)	12 TX 1611 TO IT (1372 041 015)
12 TX 1411 TD IT (1372 040 029)	12 TX 1611 TO IT (1372 041 016)
12 TX 1411 TO IT (1372 041 017)	12 TX 1810 TD IT (1372 001 251)

**EX / CROSS :**

**T94453**



**Description:**

PLANETARY CARRIER W/GEARS (33T.) ZF NEW-ECOMID

**Packaging Unit: 1**

**OEM No :**

TAS94453

**Model:**

9S 1110TD  
9S 1110TO  
9S 1115TD  
9S 1115TO  
9S 1310TO  
9S 1315TO

**EX / CROSS :**

**T63513**



**Description:**

PLANETARY CARRIER W/GEARS FOR ECOSPLIT

**Packaging Unit: 1**

**OEM No :**

TAS63513

**Model:**

12S 2830TD	16S 2523TO IT
16S 181	16S 2525TO
16S 221	Ecosplit III
16S 2320TD	Ecosplit IV - 16 speed
16S 2321TD IT	
16S 2322TD	
16S 2323TD	
16S 2325TD	
16S 232TD IT	
16S 2520TO	
16S 2521TO IT	
16S 2522TO	

**EX / CROSS :**

**T63514**



**Description:**

PLANETARY CARRIER W/GEARS FOR ECOSPLIT

**Packaging Unit: 1**

**OEM No :**

TAS63514

**Model:**

12S 2130TD	16S 181
12S 2131TD IT	16S 182
12S 2133TD	16S 1820TO
16S 151	16S 1821TO IT
16S 1620TD	16S 1822TO
16S 1621TD IT	16S 1823TO
16S 1625TD	16S 1825TO
16S 162TD IT	16S 182TO IT
16S 1630TD	16S 1830TO
16S 1631TD IT	16S 1831TO IT
16S 1635TD	16S 1833TO
16S 163TD IT	16S 1835TO

**EX / CROSS :**

**T20249**



**Description:**

PLANETARY GEAR (28T.)

**Packaging Unit: 1**

**OEM No :**

1315 332 032

**Model:**

16S 151 KMZ  
16S 151 MAN  
16S 151PTO HIN

**EX / CROSS :**

<p><b>T20500</b></p> 	<p><b>Description:</b> PLANETARY GEAR (28T.)</p> <p><b>OEM No :</b> 1316 332 031</p> <p><b>EX / CROSS :</b></p>	<p><b>Packaging Unit:</b> 1</p> <p><b>Model:</b></p>																								
<p><b>T20580</b></p> 	<p><b>Description:</b> PLANETARY GEAR (30T.)</p> <p><b>OEM No :</b> (1313 232 003/G)</p> <p><b>EX / CROSS :</b></p>	<p><b>Packaging Unit:</b> 1</p> <p><b>Model:</b></p>																								
<p><b>T22307</b></p> 	<p><b>Description:</b> PLANETARY GEAR (33T.)</p> <p><b>OEM No :</b> 1324 332 001</p> <p><b>EX / CROSS :</b></p>	<p><b>Packaging Unit:</b> 1</p> <p><b>Model:</b></p>																								
<p><b>T57504</b></p> 	<p><b>Description:</b> PLANETARY GEAR KIT (28T.)</p> <p><b>OEM No :</b> 1358 232 013</p> <p><b>EX / CROSS :</b> 1328 232 006 1358 232 010</p>	<p><b>Packaging Unit:</b> 1</p> <p><b>Model:</b></p> <table border="0"> <tr> <td>10AS 2010B IT</td> <td>12AS 1935TD</td> </tr> <tr> <td>10AS 2300BO</td> <td>12AS 2000B IT</td> </tr> <tr> <td>10AS 2310B</td> <td>12AS 2000BO</td> </tr> <tr> <td>10AS 2310B IT</td> <td>12AS 2001BO IT</td> </tr> <tr> <td>10AS 2700BO</td> <td>12AS 2130TD</td> </tr> <tr> <td>12AS 1601BO IT</td> <td>12AS 2130TO</td> </tr> <tr> <td>12AS 1630TD</td> <td>12AS 2131TD IT</td> </tr> <tr> <td>12AS 1631TD IT</td> <td>12AS 2131TO IT</td> </tr> <tr> <td>12AS 1930TD</td> <td>12AS 2140TD</td> </tr> <tr> <td>12AS 1930TO</td> <td>12AS 2300B IT</td> </tr> <tr> <td>12AS 1931TD IT</td> <td>12AS 2300BO</td> </tr> <tr> <td>12AS 1931TO IT</td> <td>12AS 2301</td> </tr> </table>	10AS 2010B IT	12AS 1935TD	10AS 2300BO	12AS 2000B IT	10AS 2310B	12AS 2000BO	10AS 2310B IT	12AS 2001BO IT	10AS 2700BO	12AS 2130TD	12AS 1601BO IT	12AS 2130TO	12AS 1630TD	12AS 2131TD IT	12AS 1631TD IT	12AS 2131TO IT	12AS 1930TD	12AS 2140TD	12AS 1930TO	12AS 2300B IT	12AS 1931TD IT	12AS 2300BO	12AS 1931TO IT	12AS 2301
10AS 2010B IT	12AS 1935TD																									
10AS 2300BO	12AS 2000B IT																									
10AS 2310B	12AS 2000BO																									
10AS 2310B IT	12AS 2001BO IT																									
10AS 2700BO	12AS 2130TD																									
12AS 1601BO IT	12AS 2130TO																									
12AS 1630TD	12AS 2131TD IT																									
12AS 1631TD IT	12AS 2131TO IT																									
12AS 1930TD	12AS 2140TD																									
12AS 1930TO	12AS 2300B IT																									
12AS 1931TD IT	12AS 2300BO																									
12AS 1931TO IT	12AS 2301																									
<p><b>T22301</b></p> 	<p><b>Description:</b> PLANETARY GEAR KIT (4 PCS.) (33T.)</p> <p><b>OEM No :</b> 1324 232 002</p> <p><b>EX / CROSS :</b></p>	<p><b>Packaging Unit:</b> 1</p> <p><b>Model:</b></p> <table border="0"> <tr> <td>9S 1110TD</td> </tr> <tr> <td>9S 1110TO</td> </tr> <tr> <td>9S 1111TD IT</td> </tr> <tr> <td>9S 1111TO IT</td> </tr> <tr> <td>9S 1115TD</td> </tr> <tr> <td>9S 1115TO</td> </tr> <tr> <td>9S 1310TO</td> </tr> <tr> <td>9S 1310TO KMZ</td> </tr> <tr> <td>9S 1311TO IT</td> </tr> <tr> <td>9S 1315TO</td> </tr> </table>	9S 1110TD	9S 1110TO	9S 1111TD IT	9S 1111TO IT	9S 1115TD	9S 1115TO	9S 1310TO	9S 1310TO KMZ	9S 1311TO IT	9S 1315TO														
9S 1110TD																										
9S 1110TO																										
9S 1111TD IT																										
9S 1111TO IT																										
9S 1115TD																										
9S 1115TO																										
9S 1310TO																										
9S 1310TO KMZ																										
9S 1311TO IT																										
9S 1315TO																										



**T80301**



**Description:**

PLANETARY GEAR KIT (5 PCS)

**Packaging Unit:** 1

**OEM No :**

1308 232 007

**Model:**

9S 75

**EX / CROSS :**

**T81209**



**Description:**

PLANETARY GEAR KIT (5 PCS)

**Packaging Unit:** 1

**OEM No :**

1304 232 051

**Model:**

8S 180  
8S 2100  
8S 2100BD  
8S 2100BO  
8S 2101BD IT  
8S 2101BO IT

**EX / CROSS :**

**T20230**



**Description:**

PLANETARY GEAR KIT (5 PCS) (28T.)

**Packaging Unit:** 1

**OEM No :**

1315 232 010

**Model:**

12S 2130TD  
12S 2131TD IT  
12S 2133TD  
16S 151  
16S 151 DAF  
16S 151 HIN  
16S 151 HYU  
16S 151 IVE  
16S 151 KMZ  
16S 151 MAN  
16S 151 RVI  
16S 151PTO HIN  
16S 1620TD  
16S 1621TD IT  
16S 1625TD  
16S 162TD IT  
16S 1630TD  
16S 1631TD IT  
16S 1635TD  
16S 163TD IT  
16S 181  
16S 181 IVE  
16S 181 MAN  
16S 181 RVI

**EX / CROSS :**

**T20474**



**Description:**

PLANETARY GEAR KIT (5 PCS) (28T.)

**Packaging Unit:** 1

**OEM No :**

1316 232 011

**Model:**

12S 2330TD  
12S 2331TD IT  
12S 2333TD  
12S 233TD IT  
12S 2830TD  
12S 2831TD IT  
12S 2833TD  
12S 283TD IT  
16S 1685  
16S 181  
16S 181IT DAF  
16S 221  
16S 221 DAF  
16S 221 MAN  
16S 221 VW  
16S 221IT RVI  
16S 2220TD  
16S 2221TD IT  
16S 2222TD  
16S 2223TD  
16S 2225TD  
16S 222TD IT  
16S 2230TD  
16S 2231TD IT

**EX / CROSS :**

**T10134**



**Description:**

PLANETARY REDUCTION GEAR (26T.)

**Packaging Unit:** 1





**OEM No :**





(000 260 1597/G)





**Model:**

**EX / CROSS :**

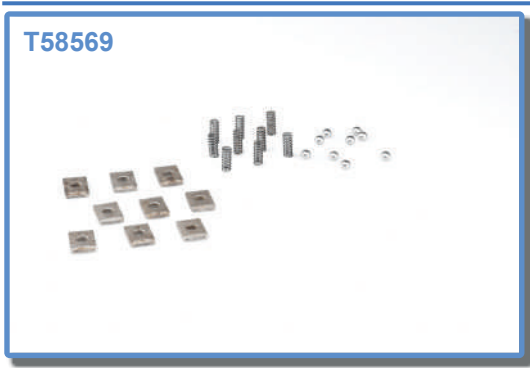

<p><b>T41561</b></p> 	<p><b>Description:</b> PLATE</p> <p><b>OEM No :</b> 1325 302 044</p> <p><b>EX / CROSS :</b></p>	<p><b>Packaging Unit:</b> 1</p> <p><b>Model:</b></p> <p>16S 1830TO 16S 1831TO IT 16S 1835TO 16S 183TO IT 16S 1930TD 16S 1931TD IT 16S 1935TD 16S 193TD IT 16S 2230TD 16S 2230TO 16S 2231TD IT 16S 2231TO IT</p> <p>16S 2235TD 16S 2235TO 16S 223TD IT 16S 223TO IT 16S 2530TO 16S 2533TO 16S 2535TO 16S 253TO IT</p>
<p><b>T61510</b></p> 	<p><b>Description:</b> PLUG</p> <p><b>OEM No :</b> 1324 207 033</p> <p><b>EX / CROSS :</b> 1296 207 004 1313 207 003</p>	<p><b>Packaging Unit:</b> 1</p> <p><b>Model:</b></p> <p>16K 130 16K 160 16K 190 16S 112 16S 112/1 16S 130 16S 130/1 16S 150 16S 160 16S 160/1 16S 160A 16S 160A/1</p> <p>16S 1685 16S 190 16S 190/1 16S 190A 16S 190A/1 16S 200 16S 220 16S 220A 8S 190</p>
<p><b>T63581</b></p> 	<p><b>Description:</b> PLUG</p> <p><b>OEM No :</b> 1324 207 035</p> <p><b>EX / CROSS :</b> 1296 207 006 1313 207 005</p>	<p><b>Packaging Unit:</b> 1</p> <p><b>Model:</b></p>
<p><b>T37749</b></p> 	<p><b>Description:</b> PRESSURE PIN (Ø7X10)</p> <p><b>OEM No :</b> 0635 470 046</p> <p><b>EX / CROSS :</b></p>	<p><b>Packaging Unit:</b> 3</p> <p><b>Model:</b></p> <p>10AS 2010B IT 10AS 2300BO 10AS 2310B 10AS 2310B IT 10AS 2700BO 12 TX 1410 TD IT (1372 001 023) 12 TX 1410 TD IT (1372 001 030) 12 TX 1410 TO (1372 002 019) 12 TX 1411 TD IT (1372 040 027) 12 TX 1411 TD IT (1372 040 224)</p> <p>12 TX 1415 TD IT (1372 001 026) 12 TX 1610 TO IT (1372 002 025) 12 TX 1610 TO IT (1372 002 045) 12 TX 1611 BO IT (1372 044 006) 12 TX 1611 BO IT (1372 044 033) 12 TX 1611 BO IT (1372 044 050) 12 TX 1611 BO IT (1372 044 241)</p>
<p><b>T08949</b></p> 	<p><b>Description:</b> PRESSURE PLUNGER</p> <p><b>OEM No :</b> 1240 304 278</p> <p><b>EX / CROSS :</b> 1285 333 007 6002 304 628</p>	<p><b>Packaging Unit:</b> 3</p> <p><b>Model:</b></p>

<p><b>T15096</b></p> 	<p><b>Description:</b> PRESSURE PLUNGER</p> <p><b>OEM No :</b> 1297 304 436</p> <p><b>EX / CROSS :</b> 1268 304 510</p>	<p><b>Packaging Unit:</b> 3</p> <p><b>Model:</b></p>
<p><b>T13455</b></p> 	<p><b>Description:</b> PRESSURE PLUNGER</p> <p><b>OEM No :</b> 1249 304 222</p> <p><b>EX / CROSS :</b> 1249 304 215</p>	<p><b>Packaging Unit:</b> 3</p> <p><b>Model:</b> 16S 109 16S 109 STR 6S 150C 8S 109 8S 140 9S 109 9S 109 MAN 9S 109 SNVI S5 24/3 S5 27 S5 35/2 S5 680 S6 36 S6 36+GV36 S6 36/2 S6 680</p>
<p><b>T09060</b></p> 	<p><b>Description:</b> PRESSURE PLUNGER</p> <p><b>OEM No :</b> 1269 328 253</p> <p><b>EX / CROSS :</b> 1269 328 234</p>	<p><b>Packaging Unit:</b> 6</p> <p><b>Model:</b></p>
<p><b>T85574</b></p> 	<p><b>Description:</b> PULSE DISK</p> <p><b>OEM No :</b> 1336 302 010</p> <p><b>EX / CROSS :</b></p>	<p><b>Packaging Unit:</b> 1</p> <p><b>Model:</b> 12AS 1210TO 12AS 1220TD 12AS 1420TD 12AS 1420TO 12AS 1620TO</p>
<p><b>T38841</b></p> 	<p><b>Description:</b> REPAIR KIT</p> <p><b>OEM No :</b> 1297 198 400</p> <p><b>EX / CROSS :</b></p>	<p><b>Packaging Unit:</b> 1</p> <p><b>Model:</b> 16S 1650 IVE 16S 1650 MAZ 16S 1685 16S 221 MB 16S 221 VW 16S 2280TO 8S 1350 KMZ</p>

<p><b>T41470</b></p> 	<p><b>Description:</b> REPAIR KIT</p> <p><b>OEM No :</b> 0501 321 146</p> <p><b>EX / CROSS :</b></p>	<p><b>Packaging Unit:</b></p> <p><b>Model:</b> AS Tronic</p>
<p><b>T58569</b></p> 	<p><b>Description:</b> REPAIR KIT</p> <p><b>OEM No :</b> 1307 198 412</p> <p><b>EX / CROSS :</b></p>	<p><b>Packaging Unit:</b> 1</p> <p><b>Model:</b> 5S 580 5S 600BO S5 42</p>
<p><b>T75240</b></p> 	<p><b>Description:</b> REPAIR KIT FOR P.T.O.</p> <p><b>OEM No :</b> 6090 190 028</p> <p><b>EX / CROSS :</b></p>	<p><b>Packaging Unit:</b> 1</p> <p><b>Model:</b></p>
<p><b>T75241</b></p> 	<p><b>Description:</b> REPAIR KIT FOR P.T.O.</p> <p><b>OEM No :</b> 6090 199 009</p> <p><b>EX / CROSS :</b></p>	<p><b>Packaging Unit:</b> 1</p> <p><b>Model:</b></p>
<p><b>T09499</b></p> 	<p><b>Description:</b> RETAINER RING</p> <p><b>OEM No :</b> 0730 361 046</p> <p><b>EX / CROSS :</b> 0730 061 190</p>	<p><b>Packaging Unit:</b> 5</p> <p><b>Model:</b></p>



<p><b>T08926</b></p> 	<p><b>Description:</b> RETAINER RING</p>	<p><b>Packaging Unit:</b> 25</p>
	<p><b>OEM No :</b> 0730 061 890</p>	<p><b>Model:</b></p>
	<p><b>EX / CROSS :</b></p>	
<p><b>T09497</b></p> 	<p><b>Description:</b> RETAINER RING</p>	<p><b>Packaging Unit:</b> 1</p>
	<p><b>OEM No :</b> 0730 061 921</p>	<p><b>Model:</b></p>
	<p><b>EX / CROSS :</b></p>	
<p><b>T39036</b></p> 	<p><b>Description:</b> RETAINER RING</p>	<p><b>Packaging Unit:</b> 1</p>
	<p><b>OEM No :</b> 0730 062 781</p>	<p><b>Model:</b></p>
	<p><b>EX / CROSS :</b></p>	<p>12S 2330TD 12S 2331TD IT 12S 233TD IT 16S 150 16S 151 16S 151 DAF 16S 151 HIN 16S 151 HYU 16S 151 IVE 16S 151 KMZ 16S 151 MAN 16S 151 RVI 16S 151 SNVI 16S 151IT DAF 16S 151PTO HIN 16S 1620TD 16S 1621TD IT 16S 1625TD 16S 162TD IT 16S 1685 16S 181 16S 181 IVE 16S 181 MAN 16S 181IT DAF</p>
<p><b>T15289</b></p> 	<p><b>Description:</b> RETAINER RING</p>	<p><b>Packaging Unit:</b> 1</p>
	<p><b>OEM No :</b> 0730 301 356</p>	<p><b>Model:</b></p>
	<p><b>EX / CROSS :</b> 0730 061 816 0501 398 753</p>	
<p><b>T19311</b></p> 	<p><b>Description:</b> RETAINER RING</p>	<p><b>Packaging Unit:</b> 20</p>
	<p><b>OEM No :</b> 0730 062 579</p>	<p><b>Model:</b></p>
	<p><b>EX / CROSS :</b></p>	<p>16K 130 16K 160 16K 190 16S 112 16S 112/1 16S 130/1 16S 151 DAF 16S 151 HYU 16S 151 RVI 16S 151 SNVI 16S 160 16S 160/1 16S 160A 16S 1650 MAZ 16S 190 16S 190/1 16S 190A 16S 200 16S 221 MB 8S 1350 KMZ 8S 190</p>

<p><b>T73071</b></p> 	<p><b>Description:</b> RETAINER RING (80X3,65)</p> <p><b>OEM No :</b> 0630 501 339</p> <p><b>EX / CROSS :</b></p>	<p><b>Packaging Unit:</b> 1</p> <p><b>Model:</b></p> <table border="0"> <tr><td>12S 2130TD</td><td>16S 1621TD IT</td></tr> <tr><td>12S 2131TD IT</td><td>16S 1625TD</td></tr> <tr><td>12S 2133TD</td><td>16S 162TD IT</td></tr> <tr><td>12S 2330TD</td><td>16S 1630TD</td></tr> <tr><td>12S 2331TD IT</td><td>16S 1631TD IT</td></tr> <tr><td>12S 2333TD</td><td>16S 1635TD</td></tr> <tr><td>12S 233TD IT</td><td>16S 163TD IT</td></tr> <tr><td>12S 2830TD</td><td>16S 1685</td></tr> <tr><td>12S 2831TD IT</td><td>16S 182</td></tr> <tr><td>12S 2833TD</td><td>16S 1820TO</td></tr> <tr><td>12S 283TD IT</td><td>16S 1821TO IT</td></tr> <tr><td>16S 1620TD</td><td>16S 1822TO</td></tr> </table>	12S 2130TD	16S 1621TD IT	12S 2131TD IT	16S 1625TD	12S 2133TD	16S 162TD IT	12S 2330TD	16S 1630TD	12S 2331TD IT	16S 1631TD IT	12S 2333TD	16S 1635TD	12S 233TD IT	16S 163TD IT	12S 2830TD	16S 1685	12S 2831TD IT	16S 182	12S 2833TD	16S 1820TO	12S 283TD IT	16S 1821TO IT	16S 1620TD	16S 1822TO
12S 2130TD	16S 1621TD IT																									
12S 2131TD IT	16S 1625TD																									
12S 2133TD	16S 162TD IT																									
12S 2330TD	16S 1630TD																									
12S 2331TD IT	16S 1631TD IT																									
12S 2333TD	16S 1635TD																									
12S 233TD IT	16S 163TD IT																									
12S 2830TD	16S 1685																									
12S 2831TD IT	16S 182																									
12S 2833TD	16S 1820TO																									
12S 283TD IT	16S 1821TO IT																									
16S 1620TD	16S 1822TO																									
<p><b>T60587</b></p> 	<p><b>Description:</b> RETAINER RING (T.2,00)</p> <p><b>OEM No :</b> 0730 513 641</p> <p><b>EX / CROSS :</b></p>	<p><b>Packaging Unit:</b> 1</p> <p><b>Model:</b></p> <table border="0"> <tr><td>10AS 2010B IT</td><td>12AS 1935TD</td></tr> <tr><td>10AS 2300BO</td><td>12AS 2000B IT</td></tr> <tr><td>10AS 2310B</td><td>12AS 2000BO</td></tr> <tr><td>10AS 2310B IT</td><td>12AS 2001BO IT</td></tr> <tr><td>10AS 2700BO</td><td>12AS 2130TD</td></tr> <tr><td>12AS 1601BO IT</td><td>12AS 2130TO</td></tr> <tr><td>12AS 1630TD</td><td>12AS 2130TD IT</td></tr> <tr><td>12AS 1631TD IT</td><td>12AS 2131TO IT</td></tr> <tr><td>12AS 1930TD</td><td>12AS 2140TD</td></tr> <tr><td>12AS 1930TO</td><td>12AS 2300B IT</td></tr> <tr><td>12AS 1931TD IT</td><td>12AS 2300BO</td></tr> <tr><td>12AS 1931TO IT</td><td>12AS 2301</td></tr> </table>	10AS 2010B IT	12AS 1935TD	10AS 2300BO	12AS 2000B IT	10AS 2310B	12AS 2000BO	10AS 2310B IT	12AS 2001BO IT	10AS 2700BO	12AS 2130TD	12AS 1601BO IT	12AS 2130TO	12AS 1630TD	12AS 2130TD IT	12AS 1631TD IT	12AS 2131TO IT	12AS 1930TD	12AS 2140TD	12AS 1930TO	12AS 2300B IT	12AS 1931TD IT	12AS 2300BO	12AS 1931TO IT	12AS 2301
10AS 2010B IT	12AS 1935TD																									
10AS 2300BO	12AS 2000B IT																									
10AS 2310B	12AS 2000BO																									
10AS 2310B IT	12AS 2001BO IT																									
10AS 2700BO	12AS 2130TD																									
12AS 1601BO IT	12AS 2130TO																									
12AS 1630TD	12AS 2130TD IT																									
12AS 1631TD IT	12AS 2131TO IT																									
12AS 1930TD	12AS 2140TD																									
12AS 1930TO	12AS 2300B IT																									
12AS 1931TD IT	12AS 2300BO																									
12AS 1931TO IT	12AS 2301																									
<p><b>T75033</b></p> 	<p><b>Description:</b> RETAINER RING (T.3,40)</p> <p><b>OEM No :</b> 0730 063 154</p> <p><b>EX / CROSS :</b></p>	<p><b>Packaging Unit:</b> 1</p> <p><b>Model:</b></p> <table border="0"> <tr><td>10AS 2010B IT</td><td>12AS 2301BO IT</td></tr> <tr><td>10AS 2310B IT</td><td>12AS 2301IT</td></tr> <tr><td>12AS 1601BO IT</td><td>12AS 2331TD IT</td></tr> <tr><td>12AS 1631TD IT</td><td>12AS 2331TO IT</td></tr> <tr><td>12AS 1800IT</td><td>12AS 2341TD IT</td></tr> <tr><td>12AS 1931TD IT</td><td>12AS 2531TO IT</td></tr> <tr><td>12AS 1931TO IT</td><td>12AS 2701BO IT</td></tr> <tr><td>12AS 2000B IT</td><td>12AS 2741TO IT</td></tr> <tr><td>12AS 2001BO IT</td><td>12AS 2941TO IT</td></tr> <tr><td>12AS 2131TD IT</td><td>12AS 3001IT</td></tr> <tr><td>12AS 2131TO IT</td><td>16AS 2200TD IT</td></tr> <tr><td>12AS 2300B IT</td><td>16AS 2231TD IT</td></tr> </table>	10AS 2010B IT	12AS 2301BO IT	10AS 2310B IT	12AS 2301IT	12AS 1601BO IT	12AS 2331TD IT	12AS 1631TD IT	12AS 2331TO IT	12AS 1800IT	12AS 2341TD IT	12AS 1931TD IT	12AS 2531TO IT	12AS 1931TO IT	12AS 2701BO IT	12AS 2000B IT	12AS 2741TO IT	12AS 2001BO IT	12AS 2941TO IT	12AS 2131TD IT	12AS 3001IT	12AS 2131TO IT	16AS 2200TD IT	12AS 2300B IT	16AS 2231TD IT
10AS 2010B IT	12AS 2301BO IT																									
10AS 2310B IT	12AS 2301IT																									
12AS 1601BO IT	12AS 2331TD IT																									
12AS 1631TD IT	12AS 2331TO IT																									
12AS 1800IT	12AS 2341TD IT																									
12AS 1931TD IT	12AS 2531TO IT																									
12AS 1931TO IT	12AS 2701BO IT																									
12AS 2000B IT	12AS 2741TO IT																									
12AS 2001BO IT	12AS 2941TO IT																									
12AS 2131TD IT	12AS 3001IT																									
12AS 2131TO IT	16AS 2200TD IT																									
12AS 2300B IT	16AS 2231TD IT																									
<p><b>T54521</b></p> 	<p><b>Description:</b> RETARDER GEAR (55T.)</p> <p><b>OEM No :</b> 1304 232 085</p> <p><b>EX / CROSS :</b> 1304 232 083</p>	<p><b>Packaging Unit:</b> 1</p> <p><b>Model:</b></p> <table border="0"> <tr><td>16S 109</td><td></td></tr> <tr><td>8S 109</td><td></td></tr> <tr><td>8S 140</td><td></td></tr> <tr><td>8S 180</td><td></td></tr> <tr><td>8S 2100</td><td></td></tr> <tr><td>8S 2101BD IT</td><td></td></tr> <tr><td>8S 2101BO IT</td><td></td></tr> <tr><td>9S 109</td><td></td></tr> <tr><td>9S 1111TD IT</td><td></td></tr> <tr><td>9S 1111TO IT</td><td></td></tr> <tr><td>9S 1311TO IT</td><td></td></tr> </table>	16S 109		8S 109		8S 140		8S 180		8S 2100		8S 2101BD IT		8S 2101BO IT		9S 109		9S 1111TD IT		9S 1111TO IT		9S 1311TO IT			
16S 109																										
8S 109																										
8S 140																										
8S 180																										
8S 2100																										
8S 2101BD IT																										
8S 2101BO IT																										
9S 109																										
9S 1111TD IT																										
9S 1111TO IT																										
9S 1311TO IT																										
<p><b>T54539</b></p> 	<p><b>Description:</b> RETARDER GEAR (57T.)</p> <p><b>OEM No :</b> 6093 204 010</p> <p><b>EX / CROSS :</b> 6093 204 001 6093 204 007</p>	<p><b>Packaging Unit:</b> 1</p> <p><b>Model:</b></p> <table border="0"> <tr><td>12S 2131TD IT</td><td>16S 183TO IT</td></tr> <tr><td>12S 2331TD IT</td><td>16S 1921TD IT</td></tr> <tr><td>12S 233TD IT</td><td>16S 1930TD</td></tr> <tr><td>12S 2831TD IT</td><td>16S 1931TD IT</td></tr> <tr><td>12S 283TD IT</td><td>16S 193TD IT</td></tr> <tr><td>16S 1621TD IT</td><td>16S 2221TD IT</td></tr> <tr><td>16S 162TD IT</td><td>16S 2221TO IT</td></tr> <tr><td>16S 1631TD IT</td><td>16S 2231TD IT</td></tr> <tr><td>16S 163TD IT</td><td>16S 2231TO IT</td></tr> <tr><td>16S 1821TO IT</td><td>16S 223TD IT</td></tr> <tr><td>16S 182TO IT</td><td>16S 223TO IT</td></tr> <tr><td>16S 1831TO IT</td><td>16S 2321TD IT</td></tr> </table>	12S 2131TD IT	16S 183TO IT	12S 2331TD IT	16S 1921TD IT	12S 233TD IT	16S 1930TD	12S 2831TD IT	16S 1931TD IT	12S 283TD IT	16S 193TD IT	16S 1621TD IT	16S 2221TD IT	16S 162TD IT	16S 2221TO IT	16S 1631TD IT	16S 2231TD IT	16S 163TD IT	16S 2231TO IT	16S 1821TO IT	16S 223TD IT	16S 182TO IT	16S 223TO IT	16S 1831TO IT	16S 2321TD IT
12S 2131TD IT	16S 183TO IT																									
12S 2331TD IT	16S 1921TD IT																									
12S 233TD IT	16S 1930TD																									
12S 2831TD IT	16S 1931TD IT																									
12S 283TD IT	16S 193TD IT																									
16S 1621TD IT	16S 2221TD IT																									
16S 162TD IT	16S 2221TO IT																									
16S 1631TD IT	16S 2231TD IT																									
16S 163TD IT	16S 2231TO IT																									
16S 1821TO IT	16S 223TD IT																									
16S 182TO IT	16S 223TO IT																									
16S 1831TO IT	16S 2321TD IT																									



**T19375**

**Description:**  
RETARDER GEAR (59-63T.)

**Packaging Unit:** 1

**OEM No :**  
1316 233 010

**Model:**  
16S 221  
16S 221IT IVE  
Ecosplit III

**EX / CROSS :**

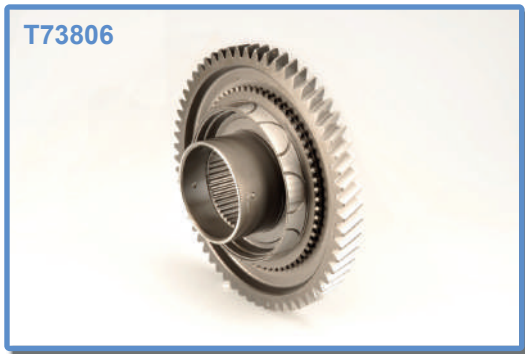

**T73806**

**Description:**  
RETARDER GEAR (59-63T.)

**Packaging Unit:** 1

**OEM No :**  
1316 233 028

**Model:**  
16S 1621TD IT  
16S 162TD IT  
16S 1820TO  
16S 1821TO IT  
16S 182TO IT  
16S 182TO IT  
16S 1921TD IT  
16S 2220TO  
16S 2220TO IT  
16S 2221TD IT  
16S 2221TO IT  
16S 222TD IT  
16S 222TO IT

16S 2321TD IT  
16S 232TD IT  
16S 2521TO IT  
16S 2523TO IT  
8S 151  
8S 1821TD IT  
8S 182TD IT  
8S 1821TO IT  
8S 182TO IT  
Ecosplit III

**EX / CROSS :**  
1316 233 016  
1316 233 014



**T73359**

**Description:**  
RETARDER GEAR (59T.)

**Packaging Unit:** 1

**OEM No :**  
1315 233 023

**Model:**  
16S 151  
Ecosplit III

**EX / CROSS :**



**T19280**

**Description:**  
REVERSE GEAR (17T.)

**Packaging Unit:** 1

**OEM No :**  
1292 305 004

**Model:**  
5S 111GP  
5S 111GP+GV90  
5S 111GPA

**EX / CROSS :**  
1292 305 002



**T22562**

**Description:**  
REVERSE GEAR (20T.)





**Packaging Unit:** 1

**OEM No :**  
1290 305 034

**Model:**  
6S 700BO  
6S 700BO KAVZ  
6S 850  
6S 850 DAF  
6S 850 MAN  
6S 890  
S6 36  
S6 36+GV36  
S6 36/2





**EX / CROSS :**  
1290 305 031  
1290 305 029  
1290 305 026  
1290 305 025



<p><b>T08511</b></p> 	<p><b>Description:</b> REVERSE GEAR (20T.)</p> <p><b>OEM No :</b> 1268 305 009</p> <p><b>EX / CROSS :</b> 1268 305 001 1268 305 003</p>	<p><b>Packaging Unit:</b> 1</p> <p><b>Model:</b></p>
<p><b>T94456</b></p> 	<p><b>Description:</b> REVERSE GEAR (20T.)</p> <p><b>OEM No :</b> 1315 305 005</p> <p><b>EX / CROSS :</b></p>	<p><b>Packaging Unit:</b> 1</p> <p><b>Model:</b> 16S 151 Ecosplit III</p>
<p><b>T20365</b></p> 	<p><b>Description:</b> REVERSE GEAR (21T.)</p> <p><b>OEM No :</b> 1269 305 005</p> <p><b>EX / CROSS :</b> 1269 305 004</p>	<p><b>Packaging Unit:</b> 1</p> <p><b>Model:</b> 5K 110GP 5K 110GP+GV90 5K 110GPA 5K 110GPA+GV90 5S 110GP 5S 110GP+GV90 5S 110GPA 5S 110GPA+GV90</p>
<p><b>T22306</b></p> 	<p><b>Description:</b> REVERSE GEAR (21T.)</p> <p><b>OEM No :</b> 1324 305 001</p> <p><b>EX / CROSS :</b></p>	<p><b>Packaging Unit:</b> 1</p> <p><b>Model:</b> 9S 109 9S 1110TD 9S 1110TO 9S 1111TD IT 9S 1111TO IT 9S 1115TD 9S 1115TO 9S 1310TO 9S 1311TO IT 9S 1315TO</p>
<p><b>T08524</b></p> 	<p><b>Description:</b> REVERSE GEAR (21T.)</p> <p><b>OEM No :</b> 1250 305 033</p> <p><b>EX / CROSS :</b> 1250 305 004 1250 305 007</p>	<p><b>Packaging Unit:</b> 1</p> <p><b>Model:</b></p>



<p><b>T20919</b></p> 	<p><b>Description:</b> REVERSE GEAR (22T.)</p> <p><b>OEM No :</b> 1315 305 011</p> <p><b>EX / CROSS :</b> 1315 305 002</p> <p><b>Model:</b> 16S 151 DAF 16S 151 HYU 16S 151 KMZ 16S 151 MAN 16S 151 RVI 16S 151 SNVI 16S 151IT DAF 16S 151PTO HIN 8S 151 DAF</p>	<p><b>Packaging Unit:</b> 1</p>
<p><b>T38701</b></p> 	<p><b>Description:</b> REVERSE GEAR (22T.)</p> <p><b>OEM No :</b> 1316 305 008</p> <p><b>EX / CROSS :</b> 1316 305 001</p> <p><b>Model:</b> 12S 2330TD 12S 2331TD IT 12S 2333TD 12S 2333TD IT 12S 2830TD 12S 2831TD IT 12S 2833TD 12S 2833TD IT 16S 1685 16S 181 16S 181 IVE 16S 181 MAN</p>	<p><b>Packaging Unit:</b> 1</p> <p>16S 181 RVI 16S 181IT DAF 16S 182 16S 1920TD 16S 1921TD IT 16S 1923TD 16S 1925TD 16S 1930TD 16S 1931TD IT 16S 1933TD 16S 1935TD 16S 1937TD IT</p>
<p><b>T23800</b></p> 	<p><b>Description:</b> REVERSE GEAR (29T.)</p> <p><b>OEM No :</b> 1307 305 026</p> <p><b>EX / CROSS :</b> 1307 305 014</p> <p><b>Model:</b> 5S 600BO S5 42 S5 42 KAVZ</p>	<p><b>Packaging Unit:</b> 1</p>
<p><b>T23794</b></p> 	<p><b>Description:</b> REVERSE GEAR (29T.)</p> <p><b>OEM No :</b> 1307 305 025</p> <p><b>EX / CROSS :</b></p> <p><b>Model:</b> S5 42 S5 42 KMZ S5 42 MAZ S5 42 SNVI S5 47</p>	<p><b>Packaging Unit:</b> 1</p>
<p><b>T22544</b></p> 	<p><b>Description:</b> REVERSE GEAR (35T.)</p> <p><b>OEM No :</b> 1290 304 058</p> <p><b>EX / CROSS :</b> 1290 304 371</p> <p><b>Model:</b> 6S 700BO 6S 700BO KAVZ 6S 850 6S 850 DAF 6S 850 MAN 6S 890 S6 36 S6 36+GV36 S6 36/2</p>	<p><b>Packaging Unit:</b> 1</p>





<p><b>T22211</b></p> 	<p><b>Description:</b> REVERSE GEAR (35T.)</p> <p><b>OEM No :</b> 1324 304 021</p> <p><b>EX / CROSS :</b> 1304 304 553</p> <p><b>Model:</b> 9S 109 9S 1110TD 9S 1110TO 9S 1111TD IT 9S 1111TO IT 9S 1115TD 9S 1115TO 9S 1310TO 9S 1311TO IT 9S 1315TO</p>	<p><b>Packaging Unit:</b> 1</p>
<p><b>T14188</b></p> 	<p><b>Description:</b> REVERSE GEAR (37-22T.)</p> <p><b>OEM No :</b> 1292 304 017</p> <p><b>EX / CROSS :</b></p>	<p><b>Packaging Unit:</b> 1</p>
<p><b>T08488</b></p> 	<p><b>Description:</b> REVERSE GEAR (38-22T.)</p> <p><b>OEM No :</b> 1283 304 022</p> <p><b>EX / CROSS :</b> 1283 304 006</p>	<p><b>Packaging Unit:</b> 1</p>
<p><b>T44698</b></p> 	<p><b>Description:</b> REVERSE GEAR (38T.)</p> <p><b>OEM No :</b> 1297 304 148</p> <p><b>EX / CROSS :</b> 0091 304 367 0091 304 210</p> <p><b>Model:</b> 16S 1600 16S 1650 16S 1650 MAZ 16S 1900</p>	<p><b>Packaging Unit:</b> 1</p>
<p><b>T20535</b></p> 	<p><b>Description:</b> REVERSE GEAR (42-23T.)</p> <p><b>OEM No :</b> 1316 304 015</p> <p><b>EX / CROSS :</b></p> <p><b>Model:</b> 16S 151PTO HIN 16S 221 16S 221 DAF 16S 221 MB Ecosplit III</p>	<p><b>Packaging Unit:</b> 1</p>



<p><b>T20520</b></p> 	<p><b>Description:</b> REVERSE GEAR (42-23T.)</p> <p><b>OEM No :</b> 1315 304 013</p> <p><b>EX / CROSS :</b></p>	<p><b>Packaging Unit:</b> 1</p> <p><b>Model:</b> 16S 151 16S 151 HIN Ecosplit III</p>
<p><b>T19542</b></p> 	<p><b>Description:</b> REVERSE GEAR (44-23T.)</p> <p><b>OEM No :</b> 1315 304 380</p> <p><b>EX / CROSS :</b> 1315 304 006</p>	<p><b>Packaging Unit:</b> 1</p> <p><b>Model:</b> 16S 151 DAF 16S 151 HYU 16S 151 IVE 16S 151 KMZ 16S 151 MAN 16S 151 RVI 16S 151 SNVI 16S 151IT DAF 16S 151PTO HIN 16S 1820TO KMZ 16S 1820TO RVI 8S 151 DAF</p>
<p><b>T19407</b></p> 	<p><b>Description:</b> REVERSE GEAR (44-23T.)</p> <p><b>OEM No :</b> 1316 304 235</p> <p><b>EX / CROSS :</b> 1316 304 012</p>	<p><b>Packaging Unit:</b> 1</p> <p><b>Model:</b> 16S 1685 16S 181 IVE 16S 181 MAN 16S 181IT DAF 16S 221 IVE 16S 221 MAN 16S 221 RVI 16S 221IT IVE 16S 221IT RVI 16S 2220TO IVE 16S 2230TO RVI 16S 2280TO 16S 251 NIS 16S 2520TO MAN</p>
<p><b>T23763</b></p> 	<p><b>Description:</b> REVERSE GEAR (44-60T.)</p> <p><b>OEM No :</b> 1307 304 650</p> <p><b>EX / CROSS :</b> 1307 204 268 1307 204 291 1307 204 309</p>	<p><b>Packaging Unit:</b> 1</p> <p><b>Model:</b> 5S 600BO S5 42 S5 42 KAVZ</p>
<p><b>T23778</b></p> 	<p><b>Description:</b> REVERSE GEAR (44T.)</p> <p><b>OEM No :</b> 1307 304 649</p> <p><b>EX / CROSS :</b> 1307 204 292 1307 204 310</p>	<p><b>Packaging Unit:</b> 1</p> <p><b>Model:</b> S5 42 S5 42 KMZ S5 42 MAZ S5 42 SNVI</p>

<p><b>T08857</b></p> 	<p><b>Description:</b> REVERSE GEAR (45-22T.)</p> <p><b>OEM No :</b> 1269 304 068</p> <p><b>EX / CROSS :</b></p>	<p><b>Packaging Unit:</b> 1</p> <p><b>Model:</b></p>
<p><b>T08460</b></p> 	<p><b>Description:</b> REVERSE GEAR (47-26T.)</p> <p><b>OEM No :</b> 1268 304 008</p> <p><b>EX / CROSS :</b> 0091 304 341</p>	<p><b>Packaging Unit:</b> 1</p> <p><b>Model:</b></p>
<p><b>T61199</b></p> 	<p><b>Description:</b> REVERSE GEAR 35 T</p> <p><b>OEM No :</b> 1304 304 672</p> <p><b>EX / CROSS :</b></p>	<p><b>Packaging Unit:</b> 1</p> <p><b>Model:</b> 8S 180 8S 2100 8S 2100BD 8S 2100BO 8S 2101BD IT 8S 2101BO IT</p>
<p><b>T57371</b></p> 	<p><b>Description:</b> RING</p> <p><b>OEM No :</b> 1328 302 075</p> <p><b>EX / CROSS :</b> 1328 302 056</p>	<p><b>Packaging Unit:</b> 1</p> <p><b>Model:</b> 10AS 2010B IT 10AS 2300BO 10AS 2310B 10AS 2310B IT 10AS 2700BO 12AS 1601BO IT 12AS 1630TD 12AS 1631TD IT 12AS 1930TD 12AS 1930TO 12AS 1931TD IT 12AS 1931TO IT 12AS 1935TD 12AS 2000B IT 12AS 2000BO 12AS 2001BO IT 12AS 2130TD 12AS 2130TO 12AS 2131TD IT 12AS 2131TO IT 12AS 2140TD 12AS 2300B IT 12AS 2300BO 12AS 2301</p>
<p><b>T50178</b></p> 	<p><b>Description:</b> RING</p> <p><b>OEM No :</b> 1315 332 073</p> <p><b>EX / CROSS :</b></p>	<p><b>Packaging Unit:</b> 1</p> <p><b>Model:</b> 12S 2130TD 12S 2131TD IT 12S 2133TD 12S 2330TD 12S 2331TD IT 12S 2333TD 12S 2333TD IT 12S 2830TD 12S 2831TD IT 12S 2833TD 12S 2833TD IT 16S 151 16S 1620TD 16S 1621TD IT 16S 1625TD 16S 162TD IT 16S 1630TD 16S 1631TD IT 16S 1635TD 16S 163TD IT 16S 1685 16S 181 16S 182 16S 1820TO</p>

<p><b>T52347</b></p> 	<p><b>Description:</b> RING</p> <p><b>OEM No :</b> 0750 112 096</p> <p><b>EX / CROSS :</b></p>	<p><b>Packaging Unit:</b> 1</p> <p><b>Model:</b> 12AS 1800 12AS 1800IT 16AS 2200TD 16AS 2200TD IT 16S 109 16S 190 16S 190/1 16S 190A/1 16S 220 16S 220A 8S 109 8S 140</p> <p>8S 180 8S 2100BD 8S 2100BO 8S 2101BD IT 8S 2101BO IT 9S 109 9S 1110TD 9S 1110TO 9S 1111TD IT 9S 1111TO IT 9S 1115TD 9S 1115TO</p>
<p><b>T22309</b></p> 	<p><b>Description:</b> RING GEAR (114T.)</p> <p><b>OEM No :</b> 1324 332 018</p> <p><b>EX / CROSS :</b> 1324 332 002</p>	<p><b>Packaging Unit:</b> 1</p> <p><b>Model:</b> 9S 1110TD 9S 1110TO 9S 1111TD IT 9S 1111TO IT 9S 1115TD 9S 1115TO 9S 1310TO 9S 1311TO IT 9S 1315TO</p>
<p><b>T20250</b></p> 	<p><b>Description:</b> RING GEAR (82T.)</p> <p><b>OEM No :</b> 1315 332 041</p> <p><b>EX / CROSS :</b> 1316 332 054</p>	<p><b>Packaging Unit:</b> 1</p> <p><b>Model:</b> 12S 2130TD 12S 2131TD IT 12S 2133TD 12S 2330TD 12S 2331TD IT 12S 2333TD 12S 2333TD IT 12S 2830TD 12S 2831TD IT 12S 2833TD 12S 2833TD IT 16S 151 16S 151 DAF 16S 151 HIN 16S 151 HYU 16S 151 IVE 16S 151 KMZ 16S 151 MAN 16S 151 RV1 16S 151PTO HIN 16S 1620TD 16S 1621TD IT 16S 1625TD 16S 1625TD IT 16S 162TD IT</p>
<p><b>T57455</b></p> 	<p><b>Description:</b> RING GEAR (82T.)</p> <p><b>OEM No :</b> 1328 332 045</p> <p><b>EX / CROSS :</b> 1328 332 009 1328 332 016</p>	<p><b>Packaging Unit:</b> 1</p> <p><b>Model:</b> 10AS 2010B IT 10AS 2300BO 10AS 2310B 10AS 2310B IT 10AS 2700BO 12AS 1601BO IT 12AS 1630TD 12AS 1631TD IT 12AS 1930TD 12AS 1930TO 12AS 1931TD IT 12AS 1931TO IT 12AS 1935TD 12AS 2000B IT 12AS 2000BO 12AS 2001BO IT 12AS 2130TD 12AS 2130TO 12AS 2131TD IT 12AS 2131TO IT 12AS 2140TD 12AS 2300B IT 12AS 2300BO 12AS 2301</p>
<p><b>T53410</b></p> 	<p><b>Description:</b> RING GEAR (83T.)</p> <p><b>OEM No :</b> 1297 332 080</p> <p><b>EX / CROSS :</b> 1297 332 036</p>	<p><b>Packaging Unit:</b> 1</p> <p><b>Model:</b> 16K 160 16K 190 16S 160 16S 160/1 16S 160A 16S 160A/1 16S 1650 16S 190 16S 190/1 16S 190A 16S 200 16S 220</p> <p>8S 190</p>

<p><b>T08925</b></p> 	<p><b>Description:</b> RING GEAR (85T.)</p> <p><b>OEM No :</b> 1269 332 055</p> <p><b>EX / CROSS :</b></p>	<p><b>Packaging Unit:</b> 1</p> <p><b>Model:</b></p>																								
<p><b>T08922</b></p> 	<p><b>Description:</b> RING GEAR (85T.)</p> <p><b>OEM No :</b> 1285 332 005</p> <p><b>EX / CROSS :</b></p>	<p><b>Packaging Unit:</b> 1</p> <p><b>Model:</b></p>																								
<p><b>T08921</b></p> 	<p><b>Description:</b> RING GEAR (85T.)</p> <p><b>OEM No :</b> 1269 332 020</p> <p><b>EX / CROSS :</b></p>	<p><b>Packaging Unit:</b> 1</p> <p><b>Model:</b></p>																								
<p><b>T74163</b></p> 	<p><b>Description:</b> RING GEAR (86T.)</p> <p><b>OEM No :</b> 1304 332 178</p> <p><b>EX / CROSS :</b> 1304 332 059</p>	<p><b>Packaging Unit:</b> 1</p> <p><b>Model:</b> 16S 109 8S 140 9S 109</p>																								
<p><b>T57444</b></p> 	<p><b>Description:</b> RING GEAR SUPPORT (82T.)</p> <p><b>OEM No :</b> 1358 332 221</p> <p><b>EX / CROSS :</b> 1328 332 024</p>	<p><b>Packaging Unit:</b> 1</p> <p><b>Model:</b></p> <table border="0"> <tr> <td>10AS 2010B IT</td> <td>12AS 1935TD</td> </tr> <tr> <td>10AS 2300BO</td> <td>12AS 2000B IT</td> </tr> <tr> <td>10AS 2310B</td> <td>12AS 2000BO</td> </tr> <tr> <td>10AS 2310B IT</td> <td>12AS 2001BO IT</td> </tr> <tr> <td>10AS 2700BO</td> <td>12AS 2130TD</td> </tr> <tr> <td>12AS 1601BO IT</td> <td>12AS 2130TO</td> </tr> <tr> <td>12AS 1630TD</td> <td>12AS 2131TD IT</td> </tr> <tr> <td>12AS 1631TD IT</td> <td>12AS 2131TO IT</td> </tr> <tr> <td>12AS 1930TD</td> <td>12AS 2140TD</td> </tr> <tr> <td>12AS 1930TO</td> <td>12AS 2300B IT</td> </tr> <tr> <td>12AS 1931TD IT</td> <td>12AS 2300BO</td> </tr> <tr> <td>12AS 1931TO IT</td> <td>12AS 2301</td> </tr> </table>	10AS 2010B IT	12AS 1935TD	10AS 2300BO	12AS 2000B IT	10AS 2310B	12AS 2000BO	10AS 2310B IT	12AS 2001BO IT	10AS 2700BO	12AS 2130TD	12AS 1601BO IT	12AS 2130TO	12AS 1630TD	12AS 2131TD IT	12AS 1631TD IT	12AS 2131TO IT	12AS 1930TD	12AS 2140TD	12AS 1930TO	12AS 2300B IT	12AS 1931TD IT	12AS 2300BO	12AS 1931TO IT	12AS 2301
10AS 2010B IT	12AS 1935TD																									
10AS 2300BO	12AS 2000B IT																									
10AS 2310B	12AS 2000BO																									
10AS 2310B IT	12AS 2001BO IT																									
10AS 2700BO	12AS 2130TD																									
12AS 1601BO IT	12AS 2130TO																									
12AS 1630TD	12AS 2131TD IT																									
12AS 1631TD IT	12AS 2131TO IT																									
12AS 1930TD	12AS 2140TD																									
12AS 1930TO	12AS 2300B IT																									
12AS 1931TD IT	12AS 2300BO																									
12AS 1931TO IT	12AS 2301																									



**Description:**  
RING GEAR SUPPORT KIT

**Packaging Unit:** 1

**OEM No :**  
1358 232 012

**Model:**  
12 TX 1410 TD IT (1372 001 023)  
12 TX 1410 TD IT (1372 001 030)  
12 TX 1410 TO (1372 002 019)  
12 TX 1411 TD IT (1372 040 027)  
12 TX 1411 TD IT (1372 040 028)  
12 TX 1411 TD IT (1372 040 029)  
12 TX 1411 TO IT (1372 041 017)  
12 TX 1611 BO IT (1372 044 050)  
12 TX 1611 BO IT (1372 044 051)  
12 TX 1611 BO IT (1372 044 071)  
12 TX 1611 BO IT (1372 044 075)  
12 TX 1611 TO IT (1372 041 015)  
12 TX 1611 TO IT (1372 041 016)  
12 TX 1810 TD IT (1372 001 055)

**EX / CROSS :**



**Description:**  
ROLLER

**Packaging Unit:** 10

**OEM No :**  
1269 302 127

**Model:**  
16K 130  
16K 160  
16K 190  
16S 112  
16S 112/1  
16S 130  
16S 130/1  
16S 150  
16S 160  
16S 160/1  
16S 160A  
16S 160A/1  
16S 190  
16S 190/1  
16S 190A  
16S 190A/1  
16S 200  
16S 220  
16S 220A  
4S 120GP  
4S 150GP  
4S 150GP+400  
5K 110GP  
5K 110GP+GV90

**EX / CROSS :**  
0635 470 012



**Description:**  
SCREW

**Packaging Unit:** 2

**OEM No :**  
1240 306 244

**Model:**

**EX / CROSS :**  
1240 306 114



**Description:**  
SCREW

**Packaging Unit:** 2

**OEM No :**  
1240 306 242

**Model:**

**EX / CROSS :**  
1240 306 167



**Description:**  
SCREW (M12X80)





**Packaging Unit:** 1

**OEM No :**  
0636 604 496

**Model:**  
16S 151PTO HIN





**EX / CROSS :**







<p><b>T72965</b></p> 	<p><b>Description:</b> SCREW (M24X1,5)</p> <p><b>OEM No :</b> 1315 334 074</p> <p><b>EX / CROSS :</b> 1315 334 011 1324 334 008</p>	<p><b>Packaging Unit:</b> 1</p> <p><b>Model:</b> 16S 109 8S 109 8S 140 8S 180 8S 2100BD 8S 2100BO 8S 2101BD IT 8S 2101BO IT 9S 109 9S 1110TD 9S 1110TO 9S 1111TD IT</p> <p>9S 1111TO IT 9S 1115TD 9S 1115TO 9S 1310TO 9S 1311TO IT 9S 1315TO</p>
<p><b>T94247</b></p> 	<p><b>Description:</b> SEAL KIT FOR AS-TRONIC ACTUATOR</p> <p><b>OEM No :</b> TAS94247</p> <p><b>EX / CROSS :</b></p>	<p><b>Packaging Unit:</b> 1</p> <p><b>Model:</b> 10AS 2010B IT 10AS 2310B IT 12AS 1630TD 12AS 1631TD IT 12AS 1800IT 12AS 1930TD 12AS 1930TO 12AS 1931TD IT 12AS 1931TO IT 12AS 1935TD 12AS 2000B IT 12AS 2001BO IT</p> <p>12AS 2131TD IT 12AS 2131TO IT 12AS 2300B IT 12AS 2301 12AS 2301BO IT 12AS 2301IT 12AS 2301TD IT 12AS 2331TO IT 12AS 2335TD 12AS 2335TO 12AS 2341TD IT 12AS 2540TD</p>
<p><b>T37686</b></p> 	<p><b>Description:</b> SEAL RING</p> <p><b>OEM No :</b> 0634 801 308</p> <p><b>EX / CROSS :</b></p>	<p><b>Packaging Unit:</b> 1</p> <p><b>Model:</b> 12AS 2302</p>
<p><b>T22042</b></p> 	<p><b>Description:</b> SEAL RING (10X14)</p> <p><b>OEM No :</b> 0730 008 055</p> <p><b>EX / CROSS :</b></p>	<p><b>Packaging Unit:</b> 10</p> <p><b>Model:</b> 16S 109 STR 16S 151 16S 151 IVE 16S 151 MAN 16S 151PTO HIN 16S 181 16S 1820TO KMZ 16S 1820TO RVI 16S 221 16S 221 MAN 16S 2220TO IVE 16S 2230TO RVI</p> <p>16S 251 16S 2520TO MAN Ecosplit III</p>
<p><b>T21662</b></p> 	<p><b>Description:</b> SEAL RING (10X14)</p> <p><b>OEM No :</b> 0634 801 013</p> <p><b>EX / CROSS :</b></p>	<p><b>Packaging Unit:</b> 1</p> <p><b>Model:</b> 12AS 2302 16S 112 16S 112/1 16S 130 16S 130/1 16S 150 16S 151 DAF 16S 151 HIN 16S 151 HYU 16S 151 KMZ 16S 151 MAN 16S 151 RVI</p> <p>16S 151 SNVI 16S 151IT DAF 16S 160 16S 160/1 16S 1650 MAZ 16S 1685 16S 181 IVE 16S 181 MAN 16S 181 RVI 16S 181IT DAF 16S 190 16S 190/1</p>















<p><b>T21693</b></p> 	<p><b>Description:</b> SEAL RING (12X15,5)</p> <p><b>OEM No :</b> 0634 801 205</p> <p><b>EX / CROSS :</b> 0634 801 164 0634 801 214</p>	<p><b>Packaging Unit:</b> 1</p> <p><b>Model:</b> 16S 109 16S 112 16S 112/1 16S 130 16S 130/1 16S 150 16S 151 HIN 16S 160 16S 160/1 16S 190 16S 190/1 16S 220</p> <p>5S 111GP 5S 111GP+GV90 5S 111GPA 6S 150C 8S 109 8S 140 8S 180 9S 109 9S 75 AK5 35/2 S5 35/2 S6 90+GV90 SNVI</p>
<p><b>T21705</b></p> 	<p><b>Description:</b> SEAL RING (12X15,5)</p> <p><b>OEM No :</b> 0634 801 246</p> <p><b>EX / CROSS :</b> 0634 801 027</p>	<p><b>Packaging Unit:</b> 1</p> <p><b>Model:</b> 16S 112 16S 112/1 16S 130 16S 130/1 16S 151 16S 160 16S 160/1 16S 190 16S 190/1 16S 221 6S 1600 6S 1600 KMZ</p> <p>6S 1900BO HYU Ecosplit III S6 66</p>
<p><b>T21667</b></p> 	<p><b>Description:</b> SEAL RING (12X16)</p> <p><b>OEM No :</b> 0634 801 028</p> <p><b>EX / CROSS :</b> 0634 801 216</p>	<p><b>Packaging Unit:</b> 1</p> <p><b>Model:</b> 16S 112 16S 112/1 16S 130 16S 130/1 16S 150 16S 151 16S 151IT DAF 16S 160 16S 160/1 16S 181IT DAF 16S 190 16S 190/1</p> <p>16S 220 16S 221 16S 221IT IVE 16S 221IT RVI 6S 1701BO XAM Ecosplit III</p>
<p><b>T21718</b></p> 	<p><b>Description:</b> SEAL RING (14X18)</p> <p><b>OEM No :</b> 0634 801 260</p> <p><b>EX / CROSS :</b> 0634 801 038</p>	<p><b>Packaging Unit:</b> 5</p> <p><b>Model:</b> 16S 112 16S 112/1 16S 130 16S 130/1 16S 160 16S 160/1 16S 1650 IVE 16S 1650 MAZ 16S 190 16S 190/1 6S 1600 6S 1600 KMZ</p> <p>6S 1900BO HYU 8S 1350 KMZ S6 66</p>
<p><b>T22049</b></p> 	<p><b>Description:</b> SEAL RING (14X19)</p> <p><b>OEM No :</b> 0730 008 057</p> <p><b>EX / CROSS :</b></p>	<p><b>Packaging Unit:</b> 1</p> <p><b>Model:</b> 16S 109 16S 109 STR 16S 151 16S 151 MAN 16S 181 16S 221 16S 251 6S 150C 8S 109 8S 140 8S 180 8S 180 ENASA</p> <p>9S 109 9S 109 MAN 9S 109 SNVI 9S 1110TD 9S 1310TO 9S 1310TO KMZ Ecosplit III</p>







<p><b>T22271</b></p> 	<p><b>Description:</b> SEAL RING (14X20)</p> <p><b>OEM No :</b> 0634 801 217</p> <p><b>EX / CROSS :</b></p>	<p><b>Packaging Unit:</b> 1</p> <p><b>Model:</b> 16S 181 RVI 16S 1820TO KMZ 16S 1820TO RVI 16S 221 IVE 16S 221 MAN 16S 221 MB 16S 221 RVI 16S 221IT IVE 16S 221IT RVI 16S 2280TO 16S 251 NIS 16S 2520TO MAN</p>
<p><b>T21668</b></p> 	<p><b>Description:</b> SEAL RING (16X22)</p> <p><b>OEM No :</b> 0634 801 050</p> <p><b>EX / CROSS :</b> 0634 801 045</p>	<p><b>Packaging Unit:</b> 10</p> <p><b>Model:</b> 16S 112 16S 112/1 16S 130 16S 130/1 16S 150 16S 160 16S 160/1 16S 1650 IVE 16S 1650 MAZ 16S 190 16S 190/1 16S 220 8S 1350 KMZ S5 680 SSO S6 1550</p>
<p><b>T22026</b></p> 	<p><b>Description:</b> SEAL RING (16X22)</p> <p><b>OEM No :</b> 0634 801 219</p> <p><b>EX / CROSS :</b> 0634 801 051 0730 008 604</p>	<p><b>Packaging Unit:</b> 1</p> <p><b>Model:</b> 16S 151 16S 151 MAN 16S 181 16S 221 16S 251 8S 180 9S 1110TO 9S 75 Ecosplit III S6 66</p>
<p><b>T21677</b></p> 	<p><b>Description:</b> SEAL RING (18X24X1,4)</p> <p><b>OEM No :</b> 0634 801 062</p> <p><b>EX / CROSS :</b></p>	<p><b>Packaging Unit:</b> 10</p> <p><b>Model:</b> 16S 109 16S 109 STR 16S 112 16S 112/1 16S 130 16S 130/1 16S 150 16S 151 16S 151 DAF 16S 151 HIN 16S 151 HYU 16S 151 IVE 16S 151 KMZ 16S 151 MAN 16S 151 RVI 16S 151 SNVI 16S 151IT DAF 16S 151PTO HIN 16S 160 16S 160/1 16S 1650 IVE 16S 1650 MAZ 16S 1685 16S 181</p>
<p><b>T21685</b></p> 	<p><b>Description:</b> SEAL RING (22X27)</p> <p><b>OEM No :</b> 0634 801 074</p> <p><b>EX / CROSS :</b> 5838 300 094</p>	<p><b>Packaging Unit:</b> 5</p> <p><b>Model:</b> 16S 112 16S 112/1 16S 130 16S 130/1 16S 150 16S 160 16S 160/1 16S 1650 IVE 16S 1650 MAZ 16S 190 16S 190/1 16S 220 8S 1350 KMZ</p>







<p><b>T22053</b></p> 	<p><b>Description:</b> SEAL RING (22X27)</p>	<p><b>Packaging Unit:</b> 10</p>
	<p><b>OEM No :</b> 0730 009 515</p>	<p><b>Model:</b> 12AS 2302 16S 151 16S 151 DAF 16S 151 HIN 16S 151 HYU 16S 151 IVE 16S 151 KMZ 16S 151 MAN 16S 151 RVI 16S 151 SNVI 16S 151IT DAF 16S 151PTO HIN 16S 1685 16S 181 16S 181 IVE 16S 181 MAN 16S 181 RVI 16S 181IT DAF 16S 1820TO KMZ 16S 1820TO RVI 16S 221 16S 221 DAF 16S 221 IVE 16S 221 MAN</p>
	<p><b>EX / CROSS :</b> 0634 801 073</p>	
<p><b>T21735</b></p> 	<p><b>Description:</b> SEAL RING (24X29)</p>	<p><b>Packaging Unit:</b> 5</p>
	<p><b>OEM No :</b> 0730 008 637</p>	<p><b>Model:</b> 10AS 2010B IT 10AS 2310B IT 12AS 1601BO IT 12AS 1631TD IT 12AS 1800IT 12AS 1930TD 12AS 1930TO 12AS 1931TD IT 12AS 1931TO IT 12AS 1935TD 12AS 2000B IT 12AS 2001BO IT 12AS 2131TD IT 12AS 2131TO IT 12AS 2300B IT 12AS 2301BO IT 12AS 2301IT 12AS 2302 12AS 2330TO 12AS 2331TD IT 12AS 2331TO IT 12AS 2335TO 12AS 2341TD IT 12AS 2531TO IT</p>
	<p><b>EX / CROSS :</b> 0634 801 236</p>	
<p><b>T22020</b></p> 	<p><b>Description:</b> SEAL RING (24X29)</p>	<p><b>Packaging Unit:</b> 1</p>
	<p><b>OEM No :</b> 0634 801 206</p>	<p><b>Model:</b> 16S 151 16S 151 MAN 16S 181 16S 221 16S 251 6S 1701BO XAM 6S 700BO KAVZ 6S 850 6S 850 DAF 6S 850 MAN Ecosplit III S5 680 SSO S6 36 S6 36+GV36</p>
	<p><b>EX / CROSS :</b></p>	
<p><b>T22033</b></p> 	<p><b>Description:</b> SEAL RING (26X31)</p>	<p><b>Packaging Unit:</b> 5</p>
	<p><b>OEM No :</b> 0634 801 249</p>	<p><b>Model:</b> 16S 151 16S 151 DAF 16S 151 HIN 16S 151 HYU 16S 151 IVE 16S 151 KMZ 16S 151 MAN 16S 151 RVI 16S 151 SNVI 16S 151IT DAF 16S 151PTO HIN 16S 1685 16S 181 16S 181 IVE 16S 181 MAN 16S 181 RVI 16S 181IT DAF 16S 1820TO KMZ 16S 1820TO RVI 16S 221 16S 221 DAF 16S 221 IVE 16S 221 MAN 16S 221 MB</p>
	<p><b>EX / CROSS :</b></p>	
<p><b>T21722</b></p> 	<p><b>Description:</b> SEAL RING (30X36)</p>	<p><b>Packaging Unit:</b> 5</p>
	<p><b>OEM No :</b> 0634 801 324</p>	<p><b>Model:</b> 16K 130 16K 160 16K 190 16S 109 16S 109 STR 16S 112 16S 112/1 16S 130 16S 130/1 16S 1300 16S 150 16S 160 16S 160/1 16S 1600 16S 160A 16S 160A/1 16S 1650 MAZ 16S 190 16S 190/1 16S 1900 16S 190A 16S 190A/1 16S 220 16S 220A</p>
	<p><b>EX / CROSS :</b> 0634 801 156</p>	





<p><b>T22012</b></p> 	<p><b>Description:</b> SEAL RING (30X36)</p> <p><b>OEM No :</b> 0634 801 097</p> <p><b>EX / CROSS :</b></p>	<p><b>Packaging Unit:</b> 1</p> <p><b>Model:</b> 16S 151 16S 151 MAN 16S 151 SNVI 16S 181 16S 221 16S 221 MB 16S 251 6S 1000TO KMZ Ecosplit III S6 66</p>
<p><b>T21715</b></p> 	<p><b>Description:</b> SEAL RING (38X44)</p> <p><b>OEM No :</b> 0634 801 250</p> <p><b>EX / CROSS :</b></p>	<p><b>Packaging Unit:</b> 1</p> <p><b>Model:</b> 16K 130 16K 160 16K 190 16S 112 16S 112/1 16S 130 16S 130/1 16S 150 16S 160 16S 160/1 16S 160A 16S 160A/1 16S 190 16S 190/1 16S 190A 16S 190A/1 16S 200 16S 220 8S 190</p>
<p><b>T22036</b></p> 	<p><b>Description:</b> SEAL RING (38X44)</p> <p><b>OEM No :</b> 0634 801 321</p> <p><b>EX / CROSS :</b></p>	<p><b>Packaging Unit:</b> 1</p> <p><b>Model:</b> 16S 109 16S 109 STR 16S 151 16S 151 MAN 16S 1650 IVE 16S 1650 MAZ 16S 181 16S 221 16S 251 6S 150C 6S 1701BO XAM 8S 109 8S 1350 KMZ 8S 140 8S 180 8S 180 ENASA 9S 109 9S 109 MAN 9S 109 SNVI 9S 1110TO 9S 1310TO KMZ Ecosplit III</p>
<p><b>T54571</b></p> 	<p><b>Description:</b> SEAL RING KIT</p> <p><b>OEM No :</b> 1295 298 801</p> <p><b>EX / CROSS :</b> 1295 298 932</p>	<p><b>Packaging Unit:</b> 1</p> <p><b>Model:</b> 16S 1300 16S 1600 16S 1900</p>
<p><b>T50181</b></p> 	<p><b>Description:</b> SEAL RING KIT</p> <p><b>OEM No :</b> 1304 298 910</p> <p><b>EX / CROSS :</b></p>	<p><b>Packaging Unit:</b> 1</p> <p><b>Model:</b> 16S 109</p>







<p><b>T20703</b></p> 	<p><b>Description:</b> SEEGER RING</p> <p><b>OEM No :</b> 0630 502 063</p> <p><b>EX / CROSS :</b></p>	<p><b>Packaging Unit:</b> 5</p> <p><b>Model:</b> 12AS 1210TO 12AS 1220TD 12AS 1420TD 12AS 1420TO 12AS 1620TO 16S 109 16S 109 STR 6S 150C 8S 109 8S 140 8S 180 8S 180 ENASA</p> <p>8S 2100BD 8S 2100BO 8S 2101BD IT 8S 2101BO IT 9S 109 9S 109 MAN 9S 109 SNVI 9S 1110TD 9S 1110TO 9S 1111TD IT 9S 1111TO IT 9S 1115TD</p>
<p><b>T18530</b></p> 	<p><b>Description:</b> SEEGER RING</p> <p><b>OEM No :</b> 0630 502 027</p> <p><b>EX / CROSS :</b></p>	<p><b>Packaging Unit:</b> 5</p> <p><b>Model:</b> 12S 2130TD 12S 2330TD 12S 2331TD IT 12S 233TD IT 16S 150 16S 151 16S 151 DAF 16S 151 HIN 16S 151 HYU 16S 151 IVE 16S 151 KMZ 16S 151 MAN</p> <p>16S 151 RVI 16S 151 SNVI 16S 151IT DAF 16S 151PTO HIN 16S 1620TD 16S 1621TD IT 16S 1625TD 16S 1625TD IT 16S 1630TD 16S 1631TD IT 16S 1635TD 16S 163TD IT</p>
<p><b>T50679</b></p> 	<p><b>Description:</b> SEEGER RING</p> <p><b>OEM No :</b> 0630 501 019</p> <p><b>EX / CROSS :</b></p>	<p><b>Packaging Unit:</b> 1</p> <p><b>Model:</b> 5S 111GP 5S 111GP+GV90 5S 111GPA 5S 90GP 5S 90GPA 5S 92GP AK6 65 AK6 65+GV80 AK6 80 AK6 80+GV80 AK6 90 AK6 90+GV90</p> <p>S6 65 S6 65+GV80 S6 80 S6 80+GV80 S6 90</p>
<p><b>T39112</b></p> 	<p><b>Description:</b> SEEGER RING (125X3,7)</p> <p><b>OEM No :</b> 0630 501 175</p> <p><b>EX / CROSS :</b></p>	<p><b>Packaging Unit:</b> 1</p> <p><b>Model:</b> 12S 2130TD 12S 2131TD IT 12S 2133TD 12S 2330TD 12S 2331TD IT 12S 2333TD 12S 233TD IT 12S 2830TD 12S 2831TD IT 12S 2833TD 12S 283TD IT 16K 130</p> <p>16K 160 16K 190 16S 112 16S 112/1 16S 130 16S 130/1 16S 1300 16S 150 16S 151 16S 151 DAF 16S 151 HIN 16S 151 HYU</p>
<p><b>T09503</b></p> 	<p><b>Description:</b> SEEGER RING (30X1,5)</p> <p><b>OEM No :</b> 0630 501 024</p> <p><b>EX / CROSS :</b></p>	<p><b>Packaging Unit:</b> 5</p> <p><b>Model:</b> HL 2/5-4,5 HL 2/9-4,7</p>

<p><b>T39113</b></p> 	<p><b>Description:</b> SEEGER RING (50X2,50)</p> <p><b>OEM No :</b> 0630 531 064</p> <p><b>EX / CROSS :</b></p>	<p><b>Packaging Unit:</b> 1</p> <p><b>Model:</b></p> <table border="0"> <tr><td>12S 2130TD</td><td>16K 160</td></tr> <tr><td>12S 2131TD IT</td><td>16K 190</td></tr> <tr><td>12S 2133TD</td><td>16S 112</td></tr> <tr><td>12S 2330TD</td><td>16S 112/1</td></tr> <tr><td>12S 2331TD IT</td><td>16S 130</td></tr> <tr><td>12S 2333TD</td><td>16S 130/1</td></tr> <tr><td>12S 2333TD IT</td><td>16S 1300</td></tr> <tr><td>12S 2830TD</td><td>16S 150</td></tr> <tr><td>12S 2831TD IT</td><td>16S 151</td></tr> <tr><td>12S 2833TD</td><td>16S 151 DAF</td></tr> <tr><td>12S 2833TD IT</td><td>16S 151 HIN</td></tr> <tr><td>12S 283TD IT</td><td>16S 151 HYU</td></tr> <tr><td>16K 130</td><td></td></tr> </table>	12S 2130TD	16K 160	12S 2131TD IT	16K 190	12S 2133TD	16S 112	12S 2330TD	16S 112/1	12S 2331TD IT	16S 130	12S 2333TD	16S 130/1	12S 2333TD IT	16S 1300	12S 2830TD	16S 150	12S 2831TD IT	16S 151	12S 2833TD	16S 151 DAF	12S 2833TD IT	16S 151 HIN	12S 283TD IT	16S 151 HYU	16K 130	
12S 2130TD	16K 160																											
12S 2131TD IT	16K 190																											
12S 2133TD	16S 112																											
12S 2330TD	16S 112/1																											
12S 2331TD IT	16S 130																											
12S 2333TD	16S 130/1																											
12S 2333TD IT	16S 1300																											
12S 2830TD	16S 150																											
12S 2831TD IT	16S 151																											
12S 2833TD	16S 151 DAF																											
12S 2833TD IT	16S 151 HIN																											
12S 283TD IT	16S 151 HYU																											
16K 130																												
<p><b>T39099</b></p> 	<p><b>Description:</b> SEEGER RING (50X2,70)</p> <p><b>OEM No :</b> 0630 501 116</p> <p><b>EX / CROSS :</b></p>	<p><b>Packaging Unit:</b> 1</p> <p><b>Model:</b></p> <table border="0"> <tr><td>12S 2130TD</td><td>16S 112/1</td></tr> <tr><td>12S 2131TD IT</td><td>16S 151 DAF</td></tr> <tr><td>12S 2133TD</td><td>16S 151 HIN</td></tr> <tr><td>12S 2330TD</td><td>16S 151 HYU</td></tr> <tr><td>12S 2331TD IT</td><td>16S 151 IVE</td></tr> <tr><td>12S 2333TD</td><td>16S 151 KMZ</td></tr> <tr><td>12S 2333TD IT</td><td>16S 151 MAN</td></tr> <tr><td>12S 2830TD</td><td>16S 151 RVI</td></tr> <tr><td>12S 2831TD IT</td><td>16S 151 SNVI</td></tr> <tr><td>12S 2833TD</td><td>16S 151IT DAF</td></tr> <tr><td>12S 283TD IT</td><td>16S 151PTO HIN</td></tr> <tr><td>16K 160</td><td>16S 160</td></tr> </table>	12S 2130TD	16S 112/1	12S 2131TD IT	16S 151 DAF	12S 2133TD	16S 151 HIN	12S 2330TD	16S 151 HYU	12S 2331TD IT	16S 151 IVE	12S 2333TD	16S 151 KMZ	12S 2333TD IT	16S 151 MAN	12S 2830TD	16S 151 RVI	12S 2831TD IT	16S 151 SNVI	12S 2833TD	16S 151IT DAF	12S 283TD IT	16S 151PTO HIN	16K 160	16S 160		
12S 2130TD	16S 112/1																											
12S 2131TD IT	16S 151 DAF																											
12S 2133TD	16S 151 HIN																											
12S 2330TD	16S 151 HYU																											
12S 2331TD IT	16S 151 IVE																											
12S 2333TD	16S 151 KMZ																											
12S 2333TD IT	16S 151 MAN																											
12S 2830TD	16S 151 RVI																											
12S 2831TD IT	16S 151 SNVI																											
12S 2833TD	16S 151IT DAF																											
12S 283TD IT	16S 151PTO HIN																											
16K 160	16S 160																											
<p><b>T39098</b></p> 	<p><b>Description:</b> SEEGER RING (50X2,90)</p> <p><b>OEM No :</b> 0630 501 112</p> <p><b>EX / CROSS :</b></p>	<p><b>Packaging Unit:</b> 1</p> <p><b>Model:</b></p> <table border="0"> <tr><td>12S 2130TD</td><td>16S 112/1</td></tr> <tr><td>12S 2131TD IT</td><td>16S 151 DAF</td></tr> <tr><td>12S 2133TD</td><td>16S 151 HIN</td></tr> <tr><td>12S 2330TD</td><td>16S 151 HYU</td></tr> <tr><td>12S 2331TD IT</td><td>16S 151 IVE</td></tr> <tr><td>12S 2333TD</td><td>16S 151 KMZ</td></tr> <tr><td>12S 2333TD IT</td><td>16S 151 MAN</td></tr> <tr><td>12S 2830TD</td><td>16S 151 RVI</td></tr> <tr><td>12S 2831TD IT</td><td>16S 151 SNVI</td></tr> <tr><td>12S 2833TD</td><td>16S 151IT DAF</td></tr> <tr><td>12S 283TD IT</td><td>16S 151PTO HIN</td></tr> <tr><td>16K 160</td><td>16S 160</td></tr> </table>	12S 2130TD	16S 112/1	12S 2131TD IT	16S 151 DAF	12S 2133TD	16S 151 HIN	12S 2330TD	16S 151 HYU	12S 2331TD IT	16S 151 IVE	12S 2333TD	16S 151 KMZ	12S 2333TD IT	16S 151 MAN	12S 2830TD	16S 151 RVI	12S 2831TD IT	16S 151 SNVI	12S 2833TD	16S 151IT DAF	12S 283TD IT	16S 151PTO HIN	16K 160	16S 160		
12S 2130TD	16S 112/1																											
12S 2131TD IT	16S 151 DAF																											
12S 2133TD	16S 151 HIN																											
12S 2330TD	16S 151 HYU																											
12S 2331TD IT	16S 151 IVE																											
12S 2333TD	16S 151 KMZ																											
12S 2333TD IT	16S 151 MAN																											
12S 2830TD	16S 151 RVI																											
12S 2831TD IT	16S 151 SNVI																											
12S 2833TD	16S 151IT DAF																											
12S 283TD IT	16S 151PTO HIN																											
16K 160	16S 160																											
<p><b>T66446</b></p> 	<p><b>Description:</b> SEEGER RING (64X2)</p> <p><b>OEM No :</b> 0630 502 218</p> <p><b>EX / CROSS :</b></p>	<p><b>Packaging Unit:</b></p> <p><b>Model:</b></p> <table border="0"> <tr><td>10AS 2010B IT</td><td>12AS 1935TD</td></tr> <tr><td>10AS 2300BO</td><td>12AS 2000B IT</td></tr> <tr><td>10AS 2310B</td><td>12AS 2000BO</td></tr> <tr><td>10AS 2310B IT</td><td>12AS 2001BO IT</td></tr> <tr><td>10AS 2700BO</td><td>12AS 2130TD</td></tr> <tr><td>12AS 1601BO IT</td><td>12AS 2130TO</td></tr> <tr><td>12AS 1630TD</td><td>12AS 2131TD IT</td></tr> <tr><td>12AS 1631TD IT</td><td>12AS 2131TO IT</td></tr> <tr><td>12AS 1930TD</td><td>12AS 2140TD</td></tr> <tr><td>12AS 1930TO</td><td>12AS 2300B IT</td></tr> <tr><td>12AS 1931TD IT</td><td>12AS 2300BO</td></tr> <tr><td>12AS 1931TO IT</td><td>12AS 2301</td></tr> </table>	10AS 2010B IT	12AS 1935TD	10AS 2300BO	12AS 2000B IT	10AS 2310B	12AS 2000BO	10AS 2310B IT	12AS 2001BO IT	10AS 2700BO	12AS 2130TD	12AS 1601BO IT	12AS 2130TO	12AS 1630TD	12AS 2131TD IT	12AS 1631TD IT	12AS 2131TO IT	12AS 1930TD	12AS 2140TD	12AS 1930TO	12AS 2300B IT	12AS 1931TD IT	12AS 2300BO	12AS 1931TO IT	12AS 2301		
10AS 2010B IT	12AS 1935TD																											
10AS 2300BO	12AS 2000B IT																											
10AS 2310B	12AS 2000BO																											
10AS 2310B IT	12AS 2001BO IT																											
10AS 2700BO	12AS 2130TD																											
12AS 1601BO IT	12AS 2130TO																											
12AS 1630TD	12AS 2131TD IT																											
12AS 1631TD IT	12AS 2131TO IT																											
12AS 1930TD	12AS 2140TD																											
12AS 1930TO	12AS 2300B IT																											
12AS 1931TD IT	12AS 2300BO																											
12AS 1931TO IT	12AS 2301																											
<p><b>T66444</b></p> 	<p><b>Description:</b> SEEGER RING (80X3,1)</p> <p><b>OEM No :</b> 0630 501 312</p> <p><b>EX / CROSS :</b></p>	<p><b>Packaging Unit:</b></p> <p><b>Model:</b></p> <table border="0"> <tr><td>12S 2130TD</td><td>16S 151</td></tr> <tr><td>12S 2131TD IT</td><td>16S 1620TD</td></tr> <tr><td>12S 2133TD</td><td>16S 1621TD IT</td></tr> <tr><td>12S 2330TD</td><td>16S 1625TD</td></tr> <tr><td>12S 2331TD IT</td><td>16S 162TD IT</td></tr> <tr><td>12S 2333TD</td><td>16S 1630TD</td></tr> <tr><td>12S 2333TD IT</td><td>16S 1631TD IT</td></tr> <tr><td>12S 2830TD</td><td>16S 1635TD</td></tr> <tr><td>12S 2831TD IT</td><td>16S 163TD IT</td></tr> <tr><td>12S 2833TD</td><td>16S 1685</td></tr> <tr><td>12S 283TD IT</td><td>16S 181</td></tr> <tr><td>16S 150</td><td>16S 182</td></tr> </table>	12S 2130TD	16S 151	12S 2131TD IT	16S 1620TD	12S 2133TD	16S 1621TD IT	12S 2330TD	16S 1625TD	12S 2331TD IT	16S 162TD IT	12S 2333TD	16S 1630TD	12S 2333TD IT	16S 1631TD IT	12S 2830TD	16S 1635TD	12S 2831TD IT	16S 163TD IT	12S 2833TD	16S 1685	12S 283TD IT	16S 181	16S 150	16S 182		
12S 2130TD	16S 151																											
12S 2131TD IT	16S 1620TD																											
12S 2133TD	16S 1621TD IT																											
12S 2330TD	16S 1625TD																											
12S 2331TD IT	16S 162TD IT																											
12S 2333TD	16S 1630TD																											
12S 2333TD IT	16S 1631TD IT																											
12S 2830TD	16S 1635TD																											
12S 2831TD IT	16S 163TD IT																											
12S 2833TD	16S 1685																											
12S 283TD IT	16S 181																											
16S 150	16S 182																											



<p><b>T19907</b></p> 	<p><b>Description:</b> SEEGER RING (T.1,50)</p> <p><b>OEM No :</b> 0630 531 055</p> <p><b>EX / CROSS :</b></p>	<p><b>Packaging Unit:</b> 1</p> <p><b>Model:</b> 12 TX 1815 TO (1372 002 035) 16S 130/1 PTO 16S 151 12AS 3141TO IT 16S 151PTO HIN 16AS 2230TD 16S 160 16AS 2600TO 16S 160/1 16AS 2630TO 16S 1635TD 16AS 2631TO IT 16S 181 16AS 2635TO 16S 190 16K 130 16S 190/1 16K 160 16S 221 16K 190 16S 2225TO 16S 112 16S 2235TD 16S 130</p>
<p><b>T09547</b></p> 	<p><b>Description:</b> SEEGER RING (T.1,75)</p> <p><b>OEM No :</b> 0630 501 033</p> <p><b>EX / CROSS :</b></p>	<p><b>Packaging Unit:</b> 1</p> <p><b>Model:</b> 5S 580 5S 600BO S5 42 S5 42 KAVZ S5 42 KMZ S5 42 MAZ S5 42 SNVI S5 420 S5 47</p>
<p><b>T09545</b></p> 	<p><b>Description:</b> SEEGER RING (T.1,75)</p> <p><b>OEM No :</b> 0630 501 031</p> <p><b>EX / CROSS :</b> 5838 300 279 5840 303 205</p>	<p><b>Packaging Unit:</b> 1</p> <p><b>Model:</b> 16S 109 STR 9S 109 MAN 5S 580 9S 109 SNVI 5S 600BO S5 42 6S 150C S5 42 KAVZ 6S 700BO S5 42 KMZ 6S 700BO KAVZ S5 42 MAZ 6S 850 S5 42 SNVI 6S 850 DAF S5 420 6S 890 S5 47 8S 109 S5 680 SSO 8S 140 S6 680 9S 109</p>
<p><b>T53644</b></p> 	<p><b>Description:</b> SEEGER RING (T.2,35)</p> <p><b>OEM No :</b> 0630 501 147</p> <p><b>EX / CROSS :</b></p>	<p><b>Packaging Unit:</b> 1</p> <p><b>Model:</b> GV4/95-6/9,0 G155-16/11,9 G155-16/14,0 G155-9/15,9 G180-16/11,9 G180-16/14,0 G200-16/11,9 G4/95-6/9,0 G71-6 G90-6 GO210-8/11,8 GO4/160-6/8,2 GV4/110-6/9,0</p>
<p><b>T58110</b></p> 	<p><b>Description:</b> SEEGER RING (T.2,50)</p> <p><b>OEM No :</b> 0630 501 050</p> <p><b>EX / CROSS :</b></p>	<p><b>Packaging Unit:</b> 1</p> <p><b>Model:</b> 16S 112 S6 90/1 16S 112/1 S6 90/1+GV90 16S 130 16S 130/1 AK6 80 AK6 80+GV80 AK6 90 AK6 90+GV90 S6 80/1 S6 80/1+GV80 S6 90 S6 90+GV90</p>

<p><b>T63639</b></p> 	<p><b>Description:</b> SEEGER RING (T.2,50)</p>	<p><b>Packaging Unit:</b> 1</p>
	<p><b>OEM No :</b> 0730 513 862</p>	<p><b>Model:</b> 16S 1822TO 16S 1922TD 16S 2222TD 16S 2222TD 16S 2322TD 16S 2522TO 6S 700BO 6S 850 6S 890 8S 180 8S 2100BD 8S 2100BO</p> <p>8S 2101BD IT 8S 2101BO IT 9S 1110TD 9S 1110TO 9S 1111TD IT 9S 1111TO IT 9S 1115TD 9S 1115TO 9S 1310TO 9S 1311TO IT 9S 1315TO</p>
<p><b>T61369</b></p> 	<p><b>Description:</b> SEEGER RING (T.3,00)</p>	<p><b>Packaging Unit:</b> 1</p>
	<p><b>OEM No :</b> 0630 531 070</p>	<p><b>Model:</b> 16S 220 6AS 700TO 6S 500 TO 6S 700BO 6S 850 6S 890 AS Tronic</p>
<p><b>T39101</b></p> 	<p><b>Description:</b> SEEGER RING (T.3,20)</p>	<p><b>Packaging Unit:</b> 1</p>
	<p><b>OEM No :</b> 0630 501 313</p>	<p><b>Model:</b> 12S 2130TD 12S 2131TD IT 12S 2133TD 12S 2330TD 12S 2331TD IT 12S 2333TD 12S 2333TD IT 12S 2830TD 12S 2831TD IT 12S 2833TD 12S 2833TD IT 16S 151 DAF</p> <p>16S 151 HIN 16S 151 HYU 16S 151 IVE 16S 151 KMZ 16S 151 MAN 16S 151 RVI 16S 151 SNVI 16S 151IT DAF 16S 151PTO HIN 16S 1620TD 16S 1621TD IT 16S 1625TD</p>
<p><b>T39102</b></p> 	<p><b>Description:</b> SEEGER RING (T.3,25)</p>	<p><b>Packaging Unit:</b> 1</p>
	<p><b>OEM No :</b> 0630 501 334</p>	<p><b>Model:</b> 12S 2130TD 12S 2131TD IT 12S 2133TD 12S 2330TD 12S 2331TD IT 12S 2333TD 12S 2333TD IT 12S 2830TD 12S 2831TD IT 12S 2833TD 12S 2833TD IT 16S 151 DAF</p> <p>16S 151 HIN 16S 151 HYU 16S 151 IVE 16S 151 KMZ 16S 151 MAN 16S 151 RVI 16S 151 SNVI 16S 151IT DAF 16S 151PTO HIN 16S 1620TD 16S 1621TD IT 16S 1625TD</p>
<p><b>T39100</b></p> 	<p><b>Description:</b> SEEGER RING (T.3,50)</p>	<p><b>Packaging Unit:</b> 1</p>
	<p><b>OEM No :</b> 0630 501 516</p>	<p><b>Model:</b> 12S 2130TD 12S 2131TD IT 12S 2133TD 12S 2330TD 12S 2331TD IT 12S 2333TD 12S 2333TD IT 12S 2830TD 12S 2831TD IT 12S 2833TD 12S 2833TD IT 16S 150</p> <p>16S 151 16S 151 DAF 16S 151 HIN 16S 151 HYU 16S 151 IVE 16S 151 KMZ 16S 151 MAN 16S 151 RVI 16S 151 SNVI 16S 151IT DAF 16S 151PTO HIN 16S 1620TD</p>



<p><b>T58473</b></p> 	<p><b>Description:</b> SEEGER RING (T.4,00)</p> <p><b>OEM No :</b> 0730 501 598</p> <p><b>EX / CROSS :</b> 0630 501 142</p> <p><b>Model:</b> 12S 2130TD 12S 2131TD IT 12S 2133TD 12S 2330TD 12S 2331TD IT 12S 2333TD 12S 2333TD IT 12S 2830TD 12S 2831TD IT 12S 2833TD 12S 283TD IT 16S 151</p>	<p><b>Packaging Unit:</b> 1</p> <p>16S 1620TD 16S 1621TD IT 16S 1625TD 16S 162TD IT 16S 1630TD 16S 1631TD IT 16S 1635TD 16S 163TD IT 16S 1685 16S 181 16S 182 16S 1820TO</p>
<p><b>T39111</b></p> 	<p><b>Description:</b> SEEGER RING (T.4,00)</p> <p><b>OEM No :</b> 0630 501 061</p> <p><b>EX / CROSS :</b></p>	<p><b>Packaging Unit:</b> 1</p> <p><b>Model:</b> 16K 130 16K 160 16K 190 16S 112 16S 112/1 16S 130 16S 130/1 16S 1300 16S 150 16S 151 16S 151 DAF 16S 151 HIN</p> <p>16S 151 HYU 16S 151 IVE 16S 151 KMZ 16S 151 MAN 16S 151 RVJ 16S 151 SNVI 16S 151IT DAF 16S 160 16S 160/1 16S 160A 16S 160A/1 16S 1620TD</p>
<p><b>T58316</b></p> 	<p><b>Description:</b> SEEGER RING MM. 4,00</p> <p><b>OEM No :</b> 0730 501 360</p> <p><b>EX / CROSS :</b></p>	<p><b>Packaging Unit:</b> 1</p> <p><b>Model:</b> 10AS 2010B IT 10AS 2300BO 10AS 2310B 10AS 2310B IT 10AS 2700BO 12AS 1601BO IT 12AS 1630TD 12AS 1631TD IT 12AS 1930TD 12AS 1930TO 12AS 1931TD IT 12AS 1931TO IT</p> <p>12AS 1935TD 12AS 2000B IT 12AS 2000BO 12AS 2001BO IT 12AS 2130TD 12AS 2130TD IT 12AS 2131TD IT 12AS 2131TO IT 12AS 2140TD 12AS 2300B IT 12AS 2300BO 12AS 2301</p>
<p><b>T67389</b></p> 	<p><b>Description:</b> SENSOR</p> <p><b>OEM No :</b> 0501 321 148</p> <p><b>EX / CROSS :</b></p>	<p><b>Packaging Unit:</b></p> <p><b>Model:</b> AS Tronic</p>
<p><b>T14758</b></p> 	<p><b>Description:</b> SHAFT (14-16T.)</p> <p><b>OEM No :</b> 1269 334 002</p> <p><b>EX / CROSS :</b></p>	<p><b>Packaging Unit:</b> 1</p> <p><b>Model:</b></p>

**T19492**



**Description:**  
SHAFT P.T.O. (12T.-14SPL.)

**Packaging Unit:** 1

**OEM No :**  
1316 303 036

**Model:**  
16S 151PTO HIN  
16S 1635TD  
16S 2225TO  
16S 2235TD  
8S 151  
Ecosplit III  
Ecosplit IV - 16 speed

**EX / CROSS :**  
1316 203 001

**T23294**



**Description:**  
SHAFT P.T.O. (14T.)

**Packaging Unit:** 1

**OEM No :**  
1304 242 006

**Model:**  
9S 1115TD  
9S 1315TO

**EX / CROSS :**

**T79969**



**Description:**  
SHAFT RETARDER (28T.)

**Packaging Unit:** 1

**OEM No :**  
6093 304 079

**Model:**  
12 TX 1411 TD IT (1372 040  
028) INT  
12 TX 1411 TD IT (1372 040  
029) INT  
12 TX 1811 TD IT (1372 040  
030) INT  
12 TX 1811 TD IT (1372 040  
031) INT  
12 TX 1811 TD IT (1372 040  
040) INT  
12 TX 1811 TD IT (1372 040  
043) INT  
12 TX 1811 TO IT (1372 041  
035) INT  
12 TX 1811 TO IT (1372 041  
041) INT  
12 TX 1811 TO IT (1372 041  
042) INT  
12 TX 1811 TO IT (1372 041  
045) INT  
12 TX 2421 TD IT (1358 040  
038) INT  
12 TX 2421 TD IT (1358 040  
051) INT

**EX / CROSS :**

**T21066**



**Description:**  
SHAFT TURBINE (18-18T.)

**Packaging Unit:** 1

**OEM No :**  
4139 333 794

**Model:**

**EX / CROSS :**  
4139 333 755

**T18748**



**Description:**  
SHIFTING CYLINDER

**Packaging Unit:** 1

**OEM No :**  
1295 334 075

**Model:**

**EX / CROSS :**  
1296 334 026  
0750 132 027  
1296 334 046  
1296 334 003

<p><b>T38486</b></p> 	<p><b>Description:</b> SHIFTING CYLINDER</p> <p><b>OEM No :</b> 1315 334 069</p> <p><b>EX / CROSS :</b> 1315 334 056</p>	<p><b>Packaging Unit:</b> 1</p> <p><b>Model:</b></p> <table border="0"> <tr><td>16S 151</td><td>16S 1820TO</td></tr> <tr><td>16S 151 DAF</td><td>16S 1820TO KMZ</td></tr> <tr><td>16S 151 IVE</td><td>16S 1820TO RVI</td></tr> <tr><td>16S 151 RVI</td><td>16S 1821TO IT</td></tr> <tr><td>16S 151 SNVI</td><td>16S 1822TO</td></tr> <tr><td>16S 151PTO HIN</td><td>16S 1823TO</td></tr> <tr><td>16S 1620TD</td><td>16S 1825TO</td></tr> <tr><td>16S 1621TD IT</td><td>16S 182TO IT</td></tr> <tr><td>16S 1625TD</td><td>16S 1920TD</td></tr> <tr><td>16S 162TD IT</td><td>16S 1921TD IT</td></tr> <tr><td>16S 1685</td><td>16S 1922TD</td></tr> <tr><td>16S 181</td><td>16S 1923TD</td></tr> </table>	16S 151	16S 1820TO	16S 151 DAF	16S 1820TO KMZ	16S 151 IVE	16S 1820TO RVI	16S 151 RVI	16S 1821TO IT	16S 151 SNVI	16S 1822TO	16S 151PTO HIN	16S 1823TO	16S 1620TD	16S 1825TO	16S 1621TD IT	16S 182TO IT	16S 1625TD	16S 1920TD	16S 162TD IT	16S 1921TD IT	16S 1685	16S 1922TD	16S 181	16S 1923TD
16S 151	16S 1820TO																									
16S 151 DAF	16S 1820TO KMZ																									
16S 151 IVE	16S 1820TO RVI																									
16S 151 RVI	16S 1821TO IT																									
16S 151 SNVI	16S 1822TO																									
16S 151PTO HIN	16S 1823TO																									
16S 1620TD	16S 1825TO																									
16S 1621TD IT	16S 182TO IT																									
16S 1625TD	16S 1920TD																									
16S 162TD IT	16S 1921TD IT																									
16S 1685	16S 1922TD																									
16S 181	16S 1923TD																									
<p><b>T38901</b></p> 	<p><b>Description:</b> SHIFTING CYLINDER</p> <p><b>OEM No :</b> 1316 312 015</p> <p><b>EX / CROSS :</b> 1316 312 011</p>	<p><b>Packaging Unit:</b> 1</p> <p><b>Model:</b></p> <table border="0"> <tr><td>16S 1685</td><td>16S 221 DAF</td></tr> <tr><td>16S 181</td><td>16S 221 IVE</td></tr> <tr><td>16S 181 IVE</td><td>16S 221 MAN</td></tr> <tr><td>16S 181 MAN</td><td>16S 221 MB</td></tr> <tr><td>16S 181 RVI</td><td>16S 221 RVI</td></tr> <tr><td>16S 181IT DAF</td><td>16S 221IT IVE</td></tr> <tr><td>16S 182</td><td>16S 221IT RVI</td></tr> <tr><td>16S 1920TD</td><td>16S 2220TD</td></tr> <tr><td>16S 1921TD IT</td><td>16S 2220TO</td></tr> <tr><td>16S 1922TD</td><td>16S 2220TO IT</td></tr> <tr><td>16S 1923TD</td><td>16S 2221TD IT</td></tr> <tr><td>16S 221</td><td>16S 2221TO IT</td></tr> </table>	16S 1685	16S 221 DAF	16S 181	16S 221 IVE	16S 181 IVE	16S 221 MAN	16S 181 MAN	16S 221 MB	16S 181 RVI	16S 221 RVI	16S 181IT DAF	16S 221IT IVE	16S 182	16S 221IT RVI	16S 1920TD	16S 2220TD	16S 1921TD IT	16S 2220TO	16S 1922TD	16S 2220TO IT	16S 1923TD	16S 2221TD IT	16S 221	16S 2221TO IT
16S 1685	16S 221 DAF																									
16S 181	16S 221 IVE																									
16S 181 IVE	16S 221 MAN																									
16S 181 MAN	16S 221 MB																									
16S 181 RVI	16S 221 RVI																									
16S 181IT DAF	16S 221IT IVE																									
16S 182	16S 221IT RVI																									
16S 1920TD	16S 2220TD																									
16S 1921TD IT	16S 2220TO																									
16S 1922TD	16S 2220TO IT																									
16S 1923TD	16S 2221TD IT																									
16S 221	16S 2221TO IT																									
<p><b>T58506</b></p> 	<p><b>Description:</b> SHIFTING CYLINDER</p> <p><b>OEM No :</b> 1325 334 013</p> <p><b>EX / CROSS :</b></p>	<p><b>Packaging Unit:</b> 1</p> <p><b>Model:</b></p> <table border="0"> <tr><td>12S 2130TD</td><td>16S 1621TD IT</td></tr> <tr><td>12S 2131TD IT</td><td>16S 1625TD</td></tr> <tr><td>12S 2133TD</td><td>16S 162TD IT</td></tr> <tr><td>12S 2330TD</td><td>16S 1630TD</td></tr> <tr><td>12S 2331TD IT</td><td>16S 1631TD IT</td></tr> <tr><td>12S 2333TD</td><td>16S 1635TD</td></tr> <tr><td>12S 233TD IT</td><td>16S 163TD IT</td></tr> <tr><td>12S 2830TD</td><td>16S 1820TO</td></tr> <tr><td>12S 2831TD IT</td><td>16S 1821TO IT</td></tr> <tr><td>12S 2833TD</td><td>16S 182TO IT</td></tr> <tr><td>12S 283TD IT</td><td>16S 1830TO</td></tr> <tr><td>16S 1620TD</td><td>16S 1831TO IT</td></tr> </table>	12S 2130TD	16S 1621TD IT	12S 2131TD IT	16S 1625TD	12S 2133TD	16S 162TD IT	12S 2330TD	16S 1630TD	12S 2331TD IT	16S 1631TD IT	12S 2333TD	16S 1635TD	12S 233TD IT	16S 163TD IT	12S 2830TD	16S 1820TO	12S 2831TD IT	16S 1821TO IT	12S 2833TD	16S 182TO IT	12S 283TD IT	16S 1830TO	16S 1620TD	16S 1831TO IT
12S 2130TD	16S 1621TD IT																									
12S 2131TD IT	16S 1625TD																									
12S 2133TD	16S 162TD IT																									
12S 2330TD	16S 1630TD																									
12S 2331TD IT	16S 1631TD IT																									
12S 2333TD	16S 1635TD																									
12S 233TD IT	16S 163TD IT																									
12S 2830TD	16S 1820TO																									
12S 2831TD IT	16S 1821TO IT																									
12S 2833TD	16S 182TO IT																									
12S 283TD IT	16S 1830TO																									
16S 1620TD	16S 1831TO IT																									
<p><b>T16712</b></p> 	<p><b>Description:</b> SHIFTING CYLINDER</p> <p><b>OEM No :</b> 1296 312 042</p> <p><b>EX / CROSS :</b> 1296 312 003 1296 312 016</p>	<p><b>Packaging Unit:</b> 1</p> <p><b>Model:</b></p>																								
<p><b>T38900</b></p> 	<p><b>Description:</b> SHIFTING CYLINDER</p> <p><b>OEM No :</b> 1315 312 048</p> <p><b>EX / CROSS :</b> 1315 312 032</p>	<p><b>Packaging Unit:</b> 1</p> <p><b>Model:</b></p> <table border="0"> <tr><td>16S 151</td><td>16S 1621TD IT</td></tr> <tr><td>16S 151 DAF</td><td>16S 1625TD</td></tr> <tr><td>16S 151 HIN</td><td>16S 162TD IT</td></tr> <tr><td>16S 151 HYU</td><td>16S 1820TO</td></tr> <tr><td>16S 151 IVE</td><td>16S 1820TO KMZ</td></tr> <tr><td>16S 151 KMZ</td><td>16S 1820TO RVI</td></tr> <tr><td>16S 151 MAN</td><td>16S 1821TO IT</td></tr> <tr><td>16S 151 RVI</td><td>16S 1822TO</td></tr> <tr><td>16S 151 SNVI</td><td>16S 1823TO</td></tr> <tr><td>16S 151IT DAF</td><td>16S 1825TO</td></tr> <tr><td>16S 151PTO HIN</td><td>16S 182TO IT</td></tr> <tr><td>16S 1620TD</td><td>8S 151</td></tr> </table>	16S 151	16S 1621TD IT	16S 151 DAF	16S 1625TD	16S 151 HIN	16S 162TD IT	16S 151 HYU	16S 1820TO	16S 151 IVE	16S 1820TO KMZ	16S 151 KMZ	16S 1820TO RVI	16S 151 MAN	16S 1821TO IT	16S 151 RVI	16S 1822TO	16S 151 SNVI	16S 1823TO	16S 151IT DAF	16S 1825TO	16S 151PTO HIN	16S 182TO IT	16S 1620TD	8S 151
16S 151	16S 1621TD IT																									
16S 151 DAF	16S 1625TD																									
16S 151 HIN	16S 162TD IT																									
16S 151 HYU	16S 1820TO																									
16S 151 IVE	16S 1820TO KMZ																									
16S 151 KMZ	16S 1820TO RVI																									
16S 151 MAN	16S 1821TO IT																									
16S 151 RVI	16S 1822TO																									
16S 151 SNVI	16S 1823TO																									
16S 151IT DAF	16S 1825TO																									
16S 151PTO HIN	16S 182TO IT																									
16S 1620TD	8S 151																									



**T17222**

**Description:**  
SHIFTING PLATE

**Packaging Unit:** 3

**OEM No :**  
1312 304 159

**Model:**

**EX / CROSS :**  
1268 304 476



**T73206**

**Description:**  
SHIFTING VALVE

**Packaging Unit:** 1

**OEM No :**  
0501 219 311

**Model:**

**EX / CROSS :**  
0501 217 295



**T81265**

**Description:**  
SHIM (T.7,05)

**Packaging Unit:** 1

**OEM No :**  
1327 304 033

**Model:**

**EX / CROSS :**

10AS 2010B IT  
10AS 2300BO  
10AS 2310B  
10AS 2310B IT  
10AS 2700BO  
12AS 1601BO IT  
12AS 1630TD  
12AS 1631TD IT  
12AS 1930TD  
12AS 1930TO  
12AS 1931TD IT  
12AS 1931TO IT  
12AS 1935TD  
12AS 2000B IT  
12AS 2000BO  
12AS 2001BO IT  
12AS 2130TD  
12AS 2130TO  
12AS 2131TD IT  
12AS 2131TO IT  
12AS 2140TD  
12AS 2300B IT  
12AS 2300BO  
12AS 2301



**T61346**

**Description:**  
SLEEVE

**Packaging Unit:**

**OEM No :**  
1325 304 225

**Model:**

**EX / CROSS :**

12S 2130TD  
12S 2131TD IT  
12S 2133TD  
12S 2331TD IT  
12S 2333TD  
12S 2833TD  
12S 283TD IT



**T13452**

**Description:**  
SLIDING BLOCK

**Packaging Unit:** 1





**OEM No :**  
1238 304 394

**Model:**





**EX / CROSS :**





16S 109  
16S 109 STR  
6S 150C  
8S 109  
8S 140  
9S 109  
9S 109 MAN  
9S 109 SNVI  
S5 35/2  
S5 680  
S6 36  
S6 36+GV36  
S6 36/2  
S6 680







<p><b>T17901</b></p> 	<p><b>Description:</b> SLIDING BLOCK</p> <p><b>OEM No :</b> 1297 306 120</p> <p><b>EX / CROSS :</b></p>	<p><b>Packaging Unit:</b> 2</p> <p><b>Model:</b></p>																								
<p><b>T09066</b></p> 	<p><b>Description:</b> SLIDING BLOCK</p> <p><b>OEM No :</b> 1283 306 003</p> <p><b>EX / CROSS :</b></p>	<p><b>Packaging Unit:</b> 2</p> <p><b>Model:</b></p>																								
<p><b>T57551</b></p> 	<p><b>Description:</b> SLIDING BLOCK</p> <p><b>OEM No :</b> 1328 312 005</p> <p><b>EX / CROSS :</b> 1314 312 018</p>	<p><b>Packaging Unit:</b> 1</p> <p><b>Model:</b></p> <table border="0"> <tr> <td>10AS 2010B IT</td> <td>12AS 1931TD IT</td> </tr> <tr> <td>10AS 2300BO</td> <td>12AS 1931TO IT</td> </tr> <tr> <td>10AS 2310B</td> <td>12AS 1935TD</td> </tr> <tr> <td>10AS 2310B IT</td> <td>12AS 2000B IT</td> </tr> <tr> <td>10AS 2700BO</td> <td>12AS 2000BO</td> </tr> <tr> <td>12AS 1601BO IT</td> <td>12AS 2001BO IT</td> </tr> <tr> <td>12AS 1630TD</td> <td>12AS 2130TD</td> </tr> <tr> <td>12AS 1631TD IT</td> <td>12AS 2130TO</td> </tr> <tr> <td>12AS 1800</td> <td>12AS 2131TD IT</td> </tr> <tr> <td>12AS 1800IT</td> <td>12AS 2131TO IT</td> </tr> <tr> <td>12AS 1930TD</td> <td>12AS 2140TD</td> </tr> <tr> <td>12AS 1930TO</td> <td>12AS 2300B IT</td> </tr> </table>	10AS 2010B IT	12AS 1931TD IT	10AS 2300BO	12AS 1931TO IT	10AS 2310B	12AS 1935TD	10AS 2310B IT	12AS 2000B IT	10AS 2700BO	12AS 2000BO	12AS 1601BO IT	12AS 2001BO IT	12AS 1630TD	12AS 2130TD	12AS 1631TD IT	12AS 2130TO	12AS 1800	12AS 2131TD IT	12AS 1800IT	12AS 2131TO IT	12AS 1930TD	12AS 2140TD	12AS 1930TO	12AS 2300B IT
10AS 2010B IT	12AS 1931TD IT																									
10AS 2300BO	12AS 1931TO IT																									
10AS 2310B	12AS 1935TD																									
10AS 2310B IT	12AS 2000B IT																									
10AS 2700BO	12AS 2000BO																									
12AS 1601BO IT	12AS 2001BO IT																									
12AS 1630TD	12AS 2130TD																									
12AS 1631TD IT	12AS 2130TO																									
12AS 1800	12AS 2131TD IT																									
12AS 1800IT	12AS 2131TO IT																									
12AS 1930TD	12AS 2140TD																									
12AS 1930TO	12AS 2300B IT																									
<p><b>T08933</b></p> 	<p><b>Description:</b> SLIDING BLOCK</p> <p><b>OEM No :</b> 1297 306 028</p> <p><b>EX / CROSS :</b> 1295 306 132</p>	<p><b>Packaging Unit:</b> 2</p> <p><b>Model:</b></p>																								
<p><b>T20293</b></p> 	<p><b>Description:</b> SLIDING BLOCK</p> <p><b>OEM No :</b> 1238 317 058</p> <p><b>EX / CROSS :</b></p>	<p><b>Packaging Unit:</b> 2</p> <p><b>Model:</b></p> <table border="0"> <tr> <td>16K 130</td> <td>16S 221</td> </tr> <tr> <td>16K 160</td> <td>16S 251</td> </tr> <tr> <td>16K 190</td> <td>5K 110GP</td> </tr> <tr> <td>16S 112</td> <td>5K 110GP+GV90</td> </tr> <tr> <td>16S 130</td> <td>5K 110GPA</td> </tr> <tr> <td>16S 130/1</td> <td>5K 110GPA+GV90</td> </tr> <tr> <td>16S 151</td> <td>5K 90GP</td> </tr> <tr> <td>16S 160</td> <td>5K 90GPA</td> </tr> <tr> <td>16S 160/1</td> <td>5K 91GP</td> </tr> <tr> <td>16S 181</td> <td>5K 91GPA</td> </tr> <tr> <td>16S 190</td> <td>5S 110GP</td> </tr> <tr> <td>16S 190/1</td> <td>5S 110GP+GV90</td> </tr> </table>	16K 130	16S 221	16K 160	16S 251	16K 190	5K 110GP	16S 112	5K 110GP+GV90	16S 130	5K 110GPA	16S 130/1	5K 110GPA+GV90	16S 151	5K 90GP	16S 160	5K 90GPA	16S 160/1	5K 91GP	16S 181	5K 91GPA	16S 190	5S 110GP	16S 190/1	5S 110GP+GV90
16K 130	16S 221																									
16K 160	16S 251																									
16K 190	5K 110GP																									
16S 112	5K 110GP+GV90																									
16S 130	5K 110GPA																									
16S 130/1	5K 110GPA+GV90																									
16S 151	5K 90GP																									
16S 160	5K 90GPA																									
16S 160/1	5K 91GP																									
16S 181	5K 91GPA																									
16S 190	5S 110GP																									
16S 190/1	5S 110GP+GV90																									



<p><b>T19201</b></p> 	<p><b>Description:</b> SLIDING BLOCK</p> <p><b>OEM No :</b> 1316 306 015</p> <p><b>EX / CROSS :</b> 1315 312 017</p>	<p><b>Packaging Unit:</b> 2</p> <p><b>Model:</b> 12AS 1210TO 12AS 1220TD 12AS 1420TD 12AS 1420TO 12AS 1620TO 12S 2130TD 12S 2131TD IT 12S 2133TD 12S 2330TD 12S 2331TD IT 12S 2333TD 12S 2333TD IT 12S 233TD IT</p> <p>12S 2830TD 12S 2831TD IT 12S 2833TD 12S 283TD IT 16S 151 16S 151 DAF 16S 151 HIN 16S 151 HYU 16S 151 IVE 16S 151 KMZ 16S 151 MAN 16S 151 RVI</p>
<p><b>T08930</b></p> 	<p><b>Description:</b> SLIDING BLOCK</p> <p><b>OEM No :</b> 1272 334 003</p> <p><b>EX / CROSS :</b> 1250 306 148</p>	<p><b>Packaging Unit:</b> 2</p> <p><b>Model:</b></p>
<p><b>T41563</b></p> 	<p><b>Description:</b> SLIDING BLOCK</p> <p><b>OEM No :</b> 1325 334 008</p> <p><b>EX / CROSS :</b></p>	<p><b>Packaging Unit:</b> 2</p> <p><b>Model:</b> 12S 2130TD 12S 2131TD IT 12S 2133TD 12S 2330TD 12S 2331TD IT 12S 2333TD 12S 2333TD IT 12S 2830TD 12S 2831TD IT 12S 2833TD 12S 283TD IT 16S 1621TD IT 16S 1625TD 16S 162TD IT 16S 1630TD 16S 1631TD IT 16S 1635TD 16S 163TD IT 16S 1820TO 16S 1821TO IT 16S 182TO IT 16S 1830TO 16S 1831TO IT</p>
<p><b>T57510</b></p> 	<p><b>Description:</b> SLIDING BLOCK</p> <p><b>OEM No :</b> 1328 334 004</p> <p><b>EX / CROSS :</b></p>	<p><b>Packaging Unit:</b> 2</p> <p><b>Model:</b> 10AS 2010B IT 10AS 2300BO 10AS 2310B 10AS 2310B IT 10AS 2700BO 12AS 1210TO 12AS 1220TD 12AS 1420TD 12AS 1420TO 12AS 1601BO IT 12AS 1620TO 12AS 1630TD</p> <p>12AS 1631TD IT 12AS 1930TD 12AS 1930TO 12AS 1931TD IT 12AS 1931TO IT 12AS 1935TD 12AS 2000B IT 12AS 2000BO 12AS 2001BO IT 12AS 2130TD 12AS 2130TO 12AS 2131TD IT</p>
<p><b>T17892</b></p> 	<p><b>Description:</b> SLIDING BLOCK</p> <p><b>OEM No :</b> 1296 334 004</p> <p><b>EX / CROSS :</b></p>	<p><b>Packaging Unit:</b> 2</p> <p><b>Model:</b></p>





<p><b>T22902</b></p> 	<p><b>Description:</b> SLIDING BLOCK</p> <p><b>OEM No :</b> 1304 306 107</p> <p><b>EX / CROSS :</b></p>	<p><b>Packaging Unit:</b> 2</p> <p><b>Model:</b> 8S 180 8S 180 ENASA 8S 2100 8S 2100BO 8S 2101BO IT 9S 1110TD 9S 1111TD IT 9S 1310TO 9S 1310TO KMZ 9S 1315TO</p>
<p><b>T08932</b></p> 	<p><b>Description:</b> SLIDING BLOCK</p> <p><b>OEM No :</b> 1295 334 027</p> <p><b>EX / CROSS :</b></p>	<p><b>Packaging Unit:</b> 2</p> <p><b>Model:</b></p>
<p><b>T22898</b></p> 	<p><b>Description:</b> SLIDING BLOCK</p> <p><b>OEM No :</b> 1290 306 439</p> <p><b>EX / CROSS :</b></p>	<p><b>Packaging Unit:</b> 2</p> <p><b>Model:</b> 6S 700BO 6S 700BO KAVZ 6S 850 6S 850 DAF 6S 850 MAN 6S 890</p>
<p><b>T09557</b></p> 	<p><b>Description:</b> SLIDING BLOCK</p> <p><b>OEM No :</b> 1307 304 156</p> <p><b>EX / CROSS :</b></p>	<p><b>Packaging Unit:</b> 3</p> <p><b>Model:</b> 5S 600BO 9S 75 S5 42 S5 42 KAVZ S5 42 KMZ S5 42 MAZ S5 42 SNVI S5 420</p>
<p><b>T11833</b></p> 	<p><b>Description:</b> SLIDING BLOCK</p> <p><b>OEM No :</b> 1317 304 081</p> <p><b>EX / CROSS :</b></p>	<p><b>Packaging Unit:</b> 3</p> <p><b>Model:</b> 5S 400V 6AS 1000TO 6AS 1005TO 6AS 1010 BO 6AS 1110BO 6AS 700TO 6AS 800TO 6AS 805TO 6S 1000TO 6S 1000TO KMZ 6S 1005TO 6S 1010BO 6S 700BO 6S 700BO KAVZ 6S 800TO 6S 850 6S 850 DAF 6S 850 MAN 6S 890 AS Tronic S5 47 S6 650</p>

<p><b>T22880</b></p> 	<p><b>Description:</b> SLIDING BLOCK</p> <p><b>OEM No :</b> 1290 306 066</p> <p><b>EX / CROSS :</b></p>	<p><b>Packaging Unit:</b> 2</p> <p><b>Model:</b></p> <p>16S 109 16S 109 STR 6AS 1000TO 6AS 1005TO 6AS 1010 BO 6AS 1110BO 6AS 700TO 6AS 800TO 6AS 805TO 6S 1000BD 6S 1000BO 6S 1000TO</p> <p>6S 1000TO KMZ 6S 1005TO 6S 1010BO 6S 1200BD 6S 1200BO 6S 1200BO IKA 6S 1200BO KMZ 6S 1200TD 6S 1200TO 6S 1205TD 6S 1350 BO 6S 150C</p>
<p><b>T22894</b></p> 	<p><b>Description:</b> SLIDING BLOCK</p> <p><b>OEM No :</b> 1290 306 423</p> <p><b>EX / CROSS :</b></p>	<p><b>Packaging Unit:</b> 2</p> <p><b>Model:</b></p> <p>6AS 1000TO 6AS 1005TO 6AS 1010 BO 6AS 1110BO 6AS 700TO 6AS 800TO 6AS 805TO 6S 1000TO 6S 1000TO KMZ 6S 1005TO 6S 1010BO 6S 500 TO</p> <p>6S 700BO 6S 700BO KAVZ 6S 800TO 6S 850 6S 850 DAF 6S 850 MAN 6S 890 AS Tronic</p>
<p><b>T08927</b></p> 	<p><b>Description:</b> SLIDING BLOCK (STEEL)</p> <p><b>OEM No :</b> 1240 306 234</p> <p><b>EX / CROSS :</b> 1240 306 171</p>	<p><b>Packaging Unit:</b> 2</p> <p><b>Model:</b></p>
<p><b>T57473</b></p> 	<p><b>Description:</b> SLIDING SLEEVE</p> <p><b>OEM No :</b> 1358 304 247</p> <p><b>EX / CROSS :</b> 1328 304 033 1328 304 062 1328 304 068</p>	<p><b>Packaging Unit:</b> 1</p> <p><b>Model:</b></p> <p>10AS 2010B IT 10AS 2300BO 10AS 2310B 10AS 2310B IT 10AS 2700BO 12AS 1601BO IT 12AS 1630TD 12AS 1631TD IT 12AS 1930TD 12AS 1930TO 12AS 1931TD IT 12AS 1931TO IT</p> <p>12AS 1935TD 12AS 2000B IT 12AS 2000BO 12AS 2001BO IT 12AS 2130TD 12AS 2130TO 12AS 2131TD IT 12AS 2131TO IT 12AS 2140TD 12AS 2300B IT 12AS 2300BO 12AS 2301</p>
<p><b>T57387</b></p> 	<p><b>Description:</b> SLIDING SLEEVE</p> <p><b>OEM No :</b> 1328 304 064</p> <p><b>EX / CROSS :</b> 1328 304 043</p>	<p><b>Packaging Unit:</b> 1</p> <p><b>Model:</b></p> <p>10AS 2010B IT 10AS 2300BO 10AS 2310B 10AS 2310B IT 10AS 2700BO 12AS 1601BO IT 12AS 1630TD 12AS 1631TD IT 12AS 1930TD 12AS 1930TO 12AS 1931TD IT 12AS 1931TO IT</p> <p>12AS 1935TD 12AS 2000B IT 12AS 2000BO 12AS 2001BO IT 12AS 2130TD 12AS 2130TO 12AS 2131TD IT 12AS 2131TO IT 12AS 2140TD 12AS 2300B IT 12AS 2300BO 12AS 2301</p>













<p><b>T57487</b></p> 	<p><b>Description:</b> SLIDING SLEEVE</p> <p><b>Packaging Unit:</b> 1</p> <p><b>OEM No :</b> 1358 333 012</p> <p><b>EX / CROSS :</b> 1328 333 003 1358 333 020</p> <p><b>Model:</b> 10AS 2010B IT 10AS 2300BO 10AS 2310B 10AS 2310B IT 10AS 2700BO 12AS 1210TO 12AS 1220TD 12AS 1420TD 12AS 1420TO 12AS 1601BO IT 12AS 1620TO 12AS 1630TD 12AS 1631TD IT 12AS 1930TD 12AS 1930TO 12AS 1931TD IT 12AS 1931TO IT 12AS 1935TD 12AS 2000B IT 12AS 2000BO 12AS 2001BO IT 12AS 2130TD 12AS 2130TO 12AS 2131TD IT</p>
<p><b>T78819</b></p> 	<p><b>Description:</b> SLIDING SLEEVE</p> <p><b>Packaging Unit:</b> 1</p> <p><b>OEM No :</b> 1358 304 253</p> <p><b>EX / CROSS :</b></p> <p><b>Model:</b> 12 TX 1410 TD IT (1372 001 023) 12 TX 1410 TD IT (1372 001 030) 12 TX 1410 TO (1372 002 019) 12 TX 1411 TD IT (1372 040 027) 12 TX 1411 TD IT (1372 040 028) 12 TX 1411 TD IT (1372 040 029) 12 TX 1411 TO IT (1372 041 017) 12 TX 1611 BO IT (1372 044 050) 12 TX 1611 BO IT (1372 044 051) 12 TX 1611 BO IT (1372 044 071) 12 TX 1611 BO IT (1372 044 075) 12 TX 1611 TO IT (1372 041 015) 12 TX 1611 TO IT (1372 041 016) 12 TX 1810 TD IT (1372 001 054)</p>
<p><b>T08917</b></p> 	<p><b>Description:</b> SLIDING SLEEVE (12T.)</p> <p><b>Packaging Unit:</b> 1</p> <p><b>OEM No :</b> 1240 317 075</p> <p><b>EX / CROSS :</b> 1240 317 002 1240 317 005 1240 317 141</p> <p><b>Model:</b></p>
<p><b>T16799</b></p> 	<p><b>Description:</b> SLIDING SLEEVE (19SPL.)</p> <p><b>Packaging Unit:</b> 1</p> <p><b>OEM No :</b> 1250 304 440</p> <p><b>EX / CROSS :</b></p> <p><b>Model:</b></p>
<p><b>T08938</b></p> 	<p><b>Description:</b> SPACER</p> <p><b>Packaging Unit:</b> 15</p> <p><b>OEM No :</b> 0730 103 102</p> <p><b>EX / CROSS :</b></p> <p><b>Model:</b></p>









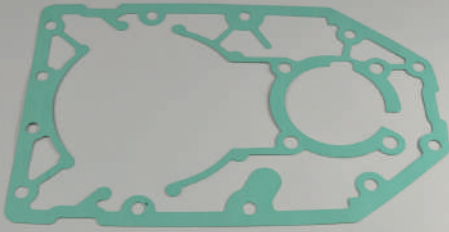

<p><b>T08939</b></p> 	<p><b>Description:</b> SPACER</p>	<p><b>Packaging Unit:</b> 15</p>																								
	<p><b>OEM No :</b> 0730 103 846</p>	<p><b>Model:</b></p>																								
	<p><b>EX / CROSS :</b></p>																									
<p><b>T15531</b></p> 	<p><b>Description:</b> SPACER</p>	<p><b>Packaging Unit:</b> 100</p>																								
	<p><b>OEM No :</b> 1205 308 016</p>	<p><b>Model:</b></p>																								
	<p><b>EX / CROSS :</b></p>																									
<p><b>T15532</b></p> 	<p><b>Description:</b> SPACER</p>	<p><b>Packaging Unit:</b> 10</p>																								
	<p><b>OEM No :</b> 1205 308 020</p>	<p><b>Model:</b></p>																								
	<p><b>EX / CROSS :</b></p>																									
<p><b>T79144</b></p> 	<p><b>Description:</b> SPACER</p>	<p><b>Packaging Unit:</b> 1</p>																								
	<p><b>OEM No :</b> 1358 303 222</p>	<p><b>Model:</b></p> <table border="0"> <tbody> <tr> <td>12 TX 1410 TD IT (1372 001 023)</td> <td>12 TX 1611 BO IT (1372 044 050)</td> </tr> <tr> <td>12 TX 1410 TD IT (1372 001 030)</td> <td>12 TX 1611 BO IT (1372 044 051)</td> </tr> <tr> <td>12 TX 1410 TO (1372 002 019)</td> <td>12 TX 1611 BO IT (1372 044 071)</td> </tr> <tr> <td>12 TX 1411 TD IT (1372 040 027)</td> <td>12 TX 1611 BO IT (1372 044 075)</td> </tr> <tr> <td>12 TX 1411 TD IT (1372 040 028)</td> <td>12 TX 1611 TO IT (1372 041 015)</td> </tr> <tr> <td>12 TX 1411 TD IT (1372 040 029)</td> <td>12 TX 1611 TO IT (1372 041 016)</td> </tr> <tr> <td>12 TX 1411 TO IT (1372 041 017)</td> <td>12 TX 1810 TD IT (1372 001 054)</td> </tr> </tbody> </table>	12 TX 1410 TD IT (1372 001 023)	12 TX 1611 BO IT (1372 044 050)	12 TX 1410 TD IT (1372 001 030)	12 TX 1611 BO IT (1372 044 051)	12 TX 1410 TO (1372 002 019)	12 TX 1611 BO IT (1372 044 071)	12 TX 1411 TD IT (1372 040 027)	12 TX 1611 BO IT (1372 044 075)	12 TX 1411 TD IT (1372 040 028)	12 TX 1611 TO IT (1372 041 015)	12 TX 1411 TD IT (1372 040 029)	12 TX 1611 TO IT (1372 041 016)	12 TX 1411 TO IT (1372 041 017)	12 TX 1810 TD IT (1372 001 054)										
12 TX 1410 TD IT (1372 001 023)	12 TX 1611 BO IT (1372 044 050)																									
12 TX 1410 TD IT (1372 001 030)	12 TX 1611 BO IT (1372 044 051)																									
12 TX 1410 TO (1372 002 019)	12 TX 1611 BO IT (1372 044 071)																									
12 TX 1411 TD IT (1372 040 027)	12 TX 1611 BO IT (1372 044 075)																									
12 TX 1411 TD IT (1372 040 028)	12 TX 1611 TO IT (1372 041 015)																									
12 TX 1411 TD IT (1372 040 029)	12 TX 1611 TO IT (1372 041 016)																									
12 TX 1411 TO IT (1372 041 017)	12 TX 1810 TD IT (1372 001 054)																									
	<p><b>EX / CROSS :</b></p>																									
<p><b>T61323</b></p> 	<p><b>Description:</b> SPACER (T.0,50)</p>	<p><b>Packaging Unit:</b> 1</p>																								
	<p><b>OEM No :</b> 1205 308 038</p>	<p><b>Model:</b></p> <table border="0"> <tbody> <tr> <td>16S 150</td> <td>S6 65</td> </tr> <tr> <td>16S 220</td> <td></td> </tr> <tr> <td>16S 220A</td> <td></td> </tr> <tr> <td>5K 110GP</td> <td></td> </tr> <tr> <td>5K 110GP+GV90</td> <td></td> </tr> <tr> <td>5K 110GPA</td> <td></td> </tr> <tr> <td>5S 110GP</td> <td></td> </tr> <tr> <td>5S 110GP+GV90</td> <td></td> </tr> <tr> <td>5S 110GPA</td> <td></td> </tr> <tr> <td>5S 110GPA+GV90</td> <td></td> </tr> <tr> <td>AK6 65</td> <td></td> </tr> <tr> <td>AK6 90</td> <td></td> </tr> </tbody> </table>	16S 150	S6 65	16S 220		16S 220A		5K 110GP		5K 110GP+GV90		5K 110GPA		5S 110GP		5S 110GP+GV90		5S 110GPA		5S 110GPA+GV90		AK6 65		AK6 90	
16S 150	S6 65																									
16S 220																										
16S 220A																										
5K 110GP																										
5K 110GP+GV90																										
5K 110GPA																										
5S 110GP																										
5S 110GP+GV90																										
5S 110GPA																										
5S 110GPA+GV90																										
AK6 65																										
AK6 90																										
	<p><b>EX / CROSS :</b> 2050 309 066</p>																									







<p><b>T39089</b></p> 	<p><b>Description:</b> SPACER (T.0,90)</p> <p><b>OEM No :</b> 0730 005 748</p> <p><b>EX / CROSS :</b></p>	<p><b>Packaging Unit:</b> 1</p> <p><b>Model:</b></p> <table border="0"> <tr><td>12S 2130TD</td><td>16S 151 HIN</td></tr> <tr><td>12S 2131TD IT</td><td>16S 151 HYU</td></tr> <tr><td>12S 2133TD</td><td>16S 151 IVE</td></tr> <tr><td>12S 2330TD</td><td>16S 151 KMZ</td></tr> <tr><td>12S 2331TD IT</td><td>16S 151 MAN</td></tr> <tr><td>12S 2333TD</td><td>16S 151 RVI</td></tr> <tr><td>12S 2333TD IT</td><td>16S 151 SNVI</td></tr> <tr><td>12S 2830TD</td><td>16S 151IT DAF</td></tr> <tr><td>12S 2831TD IT</td><td>16S 151PTO HIN</td></tr> <tr><td>12S 2833TD</td><td>16S 1620TD</td></tr> <tr><td>12S 283TD IT</td><td>16S 1621TD IT</td></tr> <tr><td>16S 151 DAF</td><td>16S 1625TD</td></tr> </table>	12S 2130TD	16S 151 HIN	12S 2131TD IT	16S 151 HYU	12S 2133TD	16S 151 IVE	12S 2330TD	16S 151 KMZ	12S 2331TD IT	16S 151 MAN	12S 2333TD	16S 151 RVI	12S 2333TD IT	16S 151 SNVI	12S 2830TD	16S 151IT DAF	12S 2831TD IT	16S 151PTO HIN	12S 2833TD	16S 1620TD	12S 283TD IT	16S 1621TD IT	16S 151 DAF	16S 1625TD
12S 2130TD	16S 151 HIN																									
12S 2131TD IT	16S 151 HYU																									
12S 2133TD	16S 151 IVE																									
12S 2330TD	16S 151 KMZ																									
12S 2331TD IT	16S 151 MAN																									
12S 2333TD	16S 151 RVI																									
12S 2333TD IT	16S 151 SNVI																									
12S 2830TD	16S 151IT DAF																									
12S 2831TD IT	16S 151PTO HIN																									
12S 2833TD	16S 1620TD																									
12S 283TD IT	16S 1621TD IT																									
16S 151 DAF	16S 1625TD																									
<p><b>T39090</b></p> 	<p><b>Description:</b> SPACER (T.0,95)</p> <p><b>OEM No :</b> 0730 005 749</p> <p><b>EX / CROSS :</b></p>	<p><b>Packaging Unit:</b> 1</p> <p><b>Model:</b></p> <table border="0"> <tr><td>12S 2130TD</td><td>16S 151 HIN</td></tr> <tr><td>12S 2131TD IT</td><td>16S 151 HYU</td></tr> <tr><td>12S 2133TD</td><td>16S 151 IVE</td></tr> <tr><td>12S 2330TD</td><td>16S 151 KMZ</td></tr> <tr><td>12S 2331TD IT</td><td>16S 151 MAN</td></tr> <tr><td>12S 2333TD</td><td>16S 151 RVI</td></tr> <tr><td>12S 2333TD IT</td><td>16S 151 SNVI</td></tr> <tr><td>12S 2830TD</td><td>16S 151IT DAF</td></tr> <tr><td>12S 2831TD IT</td><td>16S 151PTO HIN</td></tr> <tr><td>12S 2833TD</td><td>16S 1620TD</td></tr> <tr><td>12S 283TD IT</td><td>16S 1621TD IT</td></tr> <tr><td>16S 151 DAF</td><td>16S 1625TD</td></tr> </table>	12S 2130TD	16S 151 HIN	12S 2131TD IT	16S 151 HYU	12S 2133TD	16S 151 IVE	12S 2330TD	16S 151 KMZ	12S 2331TD IT	16S 151 MAN	12S 2333TD	16S 151 RVI	12S 2333TD IT	16S 151 SNVI	12S 2830TD	16S 151IT DAF	12S 2831TD IT	16S 151PTO HIN	12S 2833TD	16S 1620TD	12S 283TD IT	16S 1621TD IT	16S 151 DAF	16S 1625TD
12S 2130TD	16S 151 HIN																									
12S 2131TD IT	16S 151 HYU																									
12S 2133TD	16S 151 IVE																									
12S 2330TD	16S 151 KMZ																									
12S 2331TD IT	16S 151 MAN																									
12S 2333TD	16S 151 RVI																									
12S 2333TD IT	16S 151 SNVI																									
12S 2830TD	16S 151IT DAF																									
12S 2831TD IT	16S 151PTO HIN																									
12S 2833TD	16S 1620TD																									
12S 283TD IT	16S 1621TD IT																									
16S 151 DAF	16S 1625TD																									
<p><b>T57530</b></p> 	<p><b>Description:</b> SPACER (T.1,50)</p> <p><b>OEM No :</b> 1314 303 077</p> <p><b>EX / CROSS :</b></p>	<p><b>Packaging Unit:</b> 1</p> <p><b>Model:</b></p> <table border="0"> <tr><td>10AS 2010B IT</td><td>12AS 1931TD IT</td></tr> <tr><td>10AS 2300BO</td><td>12AS 1931TO IT</td></tr> <tr><td>10AS 2310B</td><td>12AS 1935TD</td></tr> <tr><td>10AS 2310B IT</td><td>12AS 2000B IT</td></tr> <tr><td>10AS 2700BO</td><td>12AS 2000BO</td></tr> <tr><td>12AS 1601BO IT</td><td>12AS 2001BO IT</td></tr> <tr><td>12AS 1630TD</td><td>12AS 2130TD</td></tr> <tr><td>12AS 1631TD IT</td><td>12AS 2130TO</td></tr> <tr><td>12AS 1800</td><td>12AS 2131TD IT</td></tr> <tr><td>12AS 1800IT</td><td>12AS 2131TO IT</td></tr> <tr><td>12AS 1930TD</td><td>12AS 2140TD</td></tr> <tr><td>12AS 1930TO</td><td>12AS 2300B IT</td></tr> </table>	10AS 2010B IT	12AS 1931TD IT	10AS 2300BO	12AS 1931TO IT	10AS 2310B	12AS 1935TD	10AS 2310B IT	12AS 2000B IT	10AS 2700BO	12AS 2000BO	12AS 1601BO IT	12AS 2001BO IT	12AS 1630TD	12AS 2130TD	12AS 1631TD IT	12AS 2130TO	12AS 1800	12AS 2131TD IT	12AS 1800IT	12AS 2131TO IT	12AS 1930TD	12AS 2140TD	12AS 1930TO	12AS 2300B IT
10AS 2010B IT	12AS 1931TD IT																									
10AS 2300BO	12AS 1931TO IT																									
10AS 2310B	12AS 1935TD																									
10AS 2310B IT	12AS 2000B IT																									
10AS 2700BO	12AS 2000BO																									
12AS 1601BO IT	12AS 2001BO IT																									
12AS 1630TD	12AS 2130TD																									
12AS 1631TD IT	12AS 2130TO																									
12AS 1800	12AS 2131TD IT																									
12AS 1800IT	12AS 2131TO IT																									
12AS 1930TD	12AS 2140TD																									
12AS 1930TO	12AS 2300B IT																									
<p><b>T39093</b></p> 	<p><b>Description:</b> SPACER (T.1,60)</p> <p><b>OEM No :</b> 0730 007 136</p> <p><b>EX / CROSS :</b></p>	<p><b>Packaging Unit:</b> 1</p> <p><b>Model:</b></p> <table border="0"> <tr><td>12S 2130TD</td><td>16S 151 HIN</td></tr> <tr><td>12S 2131TD IT</td><td>16S 151 HYU</td></tr> <tr><td>12S 2133TD</td><td>16S 151 IVE</td></tr> <tr><td>12S 2330TD</td><td>16S 151 KMZ</td></tr> <tr><td>12S 2331TD IT</td><td>16S 151 MAN</td></tr> <tr><td>12S 2333TD</td><td>16S 151 RVI</td></tr> <tr><td>12S 2333TD IT</td><td>16S 151 SNVI</td></tr> <tr><td>12S 2830TD</td><td>16S 151IT DAF</td></tr> <tr><td>12S 2831TD IT</td><td>16S 151PTO HIN</td></tr> <tr><td>12S 2833TD</td><td>16S 1620TD</td></tr> <tr><td>12S 283TD IT</td><td>16S 1621TD IT</td></tr> <tr><td>16S 151 DAF</td><td>16S 1625TD</td></tr> </table>	12S 2130TD	16S 151 HIN	12S 2131TD IT	16S 151 HYU	12S 2133TD	16S 151 IVE	12S 2330TD	16S 151 KMZ	12S 2331TD IT	16S 151 MAN	12S 2333TD	16S 151 RVI	12S 2333TD IT	16S 151 SNVI	12S 2830TD	16S 151IT DAF	12S 2831TD IT	16S 151PTO HIN	12S 2833TD	16S 1620TD	12S 283TD IT	16S 1621TD IT	16S 151 DAF	16S 1625TD
12S 2130TD	16S 151 HIN																									
12S 2131TD IT	16S 151 HYU																									
12S 2133TD	16S 151 IVE																									
12S 2330TD	16S 151 KMZ																									
12S 2331TD IT	16S 151 MAN																									
12S 2333TD	16S 151 RVI																									
12S 2333TD IT	16S 151 SNVI																									
12S 2830TD	16S 151IT DAF																									
12S 2831TD IT	16S 151PTO HIN																									
12S 2833TD	16S 1620TD																									
12S 283TD IT	16S 1621TD IT																									
16S 151 DAF	16S 1625TD																									
<p><b>T39092</b></p> 	<p><b>Description:</b> SPACER (T.1,90)</p> <p><b>OEM No :</b> 0730 007 484</p> <p><b>EX / CROSS :</b></p>	<p><b>Packaging Unit:</b> 1</p> <p><b>Model:</b></p> <table border="0"> <tr><td>12S 2130TD</td><td>16S 151 HIN</td></tr> <tr><td>12S 2131TD IT</td><td>16S 151 HYU</td></tr> <tr><td>12S 2133TD</td><td>16S 151 IVE</td></tr> <tr><td>12S 2330TD</td><td>16S 151 KMZ</td></tr> <tr><td>12S 2331TD IT</td><td>16S 151 MAN</td></tr> <tr><td>12S 2333TD</td><td>16S 151 RVI</td></tr> <tr><td>12S 2333TD IT</td><td>16S 151 SNVI</td></tr> <tr><td>12S 2830TD</td><td>16S 151IT DAF</td></tr> <tr><td>12S 2831TD IT</td><td>16S 151PTO HIN</td></tr> <tr><td>12S 2833TD</td><td>16S 1620TD</td></tr> <tr><td>12S 283TD IT</td><td>16S 1621TD IT</td></tr> <tr><td>16S 151 DAF</td><td>16S 1625TD</td></tr> </table>	12S 2130TD	16S 151 HIN	12S 2131TD IT	16S 151 HYU	12S 2133TD	16S 151 IVE	12S 2330TD	16S 151 KMZ	12S 2331TD IT	16S 151 MAN	12S 2333TD	16S 151 RVI	12S 2333TD IT	16S 151 SNVI	12S 2830TD	16S 151IT DAF	12S 2831TD IT	16S 151PTO HIN	12S 2833TD	16S 1620TD	12S 283TD IT	16S 1621TD IT	16S 151 DAF	16S 1625TD
12S 2130TD	16S 151 HIN																									
12S 2131TD IT	16S 151 HYU																									
12S 2133TD	16S 151 IVE																									
12S 2330TD	16S 151 KMZ																									
12S 2331TD IT	16S 151 MAN																									
12S 2333TD	16S 151 RVI																									
12S 2333TD IT	16S 151 SNVI																									
12S 2830TD	16S 151IT DAF																									
12S 2831TD IT	16S 151PTO HIN																									
12S 2833TD	16S 1620TD																									
12S 283TD IT	16S 1621TD IT																									
16S 151 DAF	16S 1625TD																									

<p><b>T39091</b></p> 	<p><b>Description:</b> SPACER (T.2,15)</p>	<p><b>Packaging Unit:</b> 1</p>
	<p><b>OEM No :</b> 0730 007 489</p>	<p><b>Model:</b> 12S 2130TD 12S 2131TD IT 12S 2133TD 12S 2330TD 12S 2331TD IT 12S 2333TD 12S 2333TD IT 12S 2830TD 12S 2831TD IT 12S 2833TD 12S 2833TD IT 12S 283TD IT 16S 151 DAF 16S 151 HIN 16S 151 HYU 16S 151 IVE 16S 151 KMZ 16S 151 MAN 16S 151 RVI 16S 151 SNVI 16S 151IT DAF 16S 151PTO HIN 16S 1620TD 16S 1621TD IT 16S 1625TD</p>
	<p><b>EX / CROSS :</b></p>	
<p><b>T50158</b></p> 	<p><b>Description:</b> SPACER (T.2,90)</p>	<p><b>Packaging Unit:</b> 1</p>
	<p><b>OEM No :</b> 0730 004 796</p>	<p><b>Model:</b> 6S 150C 8S 109 8S 140 9S 109</p>
	<p><b>EX / CROSS :</b></p>	
<p><b>T39109</b></p> 	<p><b>Description:</b> SPACER (T.3,40)</p>	<p><b>Packaging Unit:</b> 1</p>
	<p><b>OEM No :</b> 0730 005 465</p>	<p><b>Model:</b> 16S 151 DAF 16S 151 HIN 16S 151 HYU 16S 151 KMZ 16S 151 MAN 16S 151 RVI 16S 151 SNVI 16S 151IT DAF 16S 181 IVE 16S 181 MAN 16S 181 RVI 16S 181IT DAF 16S 221 DAF 16S 221 IVE 16S 221 MAN 16S 221 MB 16S 221 RVI 16S 221IT IVE 16S 221IT RVI 16S 251 NIS</p>
	<p><b>EX / CROSS :</b></p>	
<p><b>T64474</b></p> 	<p><b>Description:</b> SPACER L. 7,10 MM.</p>	<p><b>Packaging Unit:</b></p>
	<p><b>OEM No :</b> 1327 304 034</p>	<p><b>Model:</b> 10AS 2010B IT 10AS 2300BO 10AS 2310B 10AS 2310B IT 10AS 2700BO 12AS 1601BO IT 12AS 1630TD 12AS 1631TD IT 12AS 1930TD 12AS 1930TO 12AS 1931TD IT 12AS 1931TO IT 12AS 1935TD 12AS 2000B IT 12AS 2000BO 12AS 2001BO IT 12AS 2130TD 12AS 2130TO 12AS 2131TD IT 12AS 2131TO IT 12AS 2140TD 12AS 2300B IT 12AS 2300BO 12AS 2301</p>
	<p><b>EX / CROSS :</b></p>	
<p><b>T64476</b></p> 	<p><b>Description:</b> SPACER L. 7,15 MM.</p>	<p><b>Packaging Unit:</b></p>
	<p><b>OEM No :</b> 1327 304 035</p>	<p><b>Model:</b> 10AS 2010B IT 10AS 2300BO 10AS 2310B 10AS 2310B IT 10AS 2700BO 12AS 1601BO IT 12AS 1630TD 12AS 1631TD IT 12AS 1930TD 12AS 1930TO 12AS 1931TD IT 12AS 1931TO IT 12AS 1935TD 12AS 2000B IT 12AS 2000BO 12AS 2001BO IT 12AS 2130TD 12AS 2130TO 12AS 2131TD IT 12AS 2131TO IT 12AS 2140TD 12AS 2300B IT 12AS 2300BO 12AS 2301</p>
	<p><b>EX / CROSS :</b></p>	





<p><b>T64483</b></p> 	<p><b>Description:</b> SPACER L. 7,20 MM.</p> <p><b>Packaging Unit:</b> 1</p> <p><b>OEM No :</b> 1327 304 036</p> <p><b>EX / CROSS :</b></p> <p><b>Model:</b> 10AS 2010B IT 10AS 2300BO 10AS 2310B 10AS 2310B IT 10AS 2700BO 12AS 1601BO IT 12AS 1630TD 12AS 1631TD IT 12AS 1930TD 12AS 1930TO 12AS 1931TD IT 12AS 1931TO IT</p> <p>12AS 1935TD 12AS 2000B IT 12AS 2000BO 12AS 2001BO IT 12AS 2130TD 12AS 2130TO 12AS 2131TD IT 12AS 2131TO IT 12AS 2140TD 12AS 2300B IT 12AS 2300BO 12AS 2301</p>
<p><b>T21429</b></p> 	<p><b>Description:</b> SPEEDOMETER COVER GASKET</p> <p><b>Packaging Unit:</b> 1</p> <p><b>OEM No :</b> 1269 338 110</p> <p><b>EX / CROSS :</b> 0501 315 085</p> <p><b>Model:</b> 4S 150GP 4S 150GP+400 5K 110GP 5K 110GP+GV90 5K 110GPA 5K 110GPA+GV90 5S 110GP 5S 110GP+GV90 5S 110GPA 5S 110GPA+GV90 5S 111GP 5S 111GP+GV90</p> <p>5S 111GPA</p>
<p><b>T20451</b></p> 	<p><b>Description:</b> SPEEDOMETER DRIVE GEAR (11T.)</p> <p><b>Packaging Unit:</b> 1</p> <p><b>OEM No :</b> 1269 328 229</p> <p><b>EX / CROSS :</b></p> <p><b>Model:</b> 4S 150GP 4S 150GP+400 5K 110GP 5K 110GP+GV90 5K 110GPA 5K 110GPA+GV90 5S 110GP 5S 110GP+GV90 5S 110GPA 5S 110GPA+GV90 5S 111GP 5S 111GP+GV90</p> <p>5S 111GPA S6 65 S6 65+GV80 S6 80+GV80 S6 90 S6 90/1</p>
<p><b>T19347</b></p> 	<p><b>Description:</b> SPLIT RING (T.4,00)</p> <p><b>Packaging Unit:</b> 1</p> <p><b>OEM No :</b> 0730 105 156</p> <p><b>EX / CROSS :</b></p> <p><b>Model:</b> 16K 130 16K 160 16K 190 16S 112 16S 112/1 16S 130/1 16S 160 16S 160/1 16S 160A 16S 190 16S 190/1 16S 190A</p> <p>16S 200 8S 190</p>
<p><b>T39087</b></p> 	<p><b>Description:</b> SPLIT RING KIT (T.3,50)</p> <p><b>Packaging Unit:</b> 1</p> <p><b>OEM No :</b> 1499 298 160</p> <p><b>EX / CROSS :</b></p> <p><b>Model:</b> 12 TX 1410 TD IT (1372 001 023) 12 TX 1410 TD IT (1372 001 030) 12 TX 1410 TO (1372 002 019) 12 TX 1411 TD IT (1372 040 027) 12 TX 1411 TD IT (1372 040 028) 12 TX 1411 TD IT (1372 040 029) 12 TX 1411 TO IT (1372 041 017) 12 TX 1611 BO IT (1372 044 050) 12 TX 1611 BO IT (1372 044 051) 12 TX 1611 BO IT (1372 044 071) 12 TX 1611 BO IT (1372 044 075) 12 TX 1611 TO IT (1372 041 015) 12 TX 1611 TO IT (1372 041 016) 12 TX 1810 TD IT (1372 001 024)</p>

<p><b>T39088</b></p> 	<p><b>Description:</b> SPLIT RING KIT (T.3,70)</p> <p><b>OEM No :</b> 1499 298 156</p> <p><b>EX / CROSS :</b></p>	<p><b>Packaging Unit:</b> 1</p> <p><b>Model:</b> 8S 109</p>
<p><b>T19341</b></p> 	<p><b>Description:</b> SPLIT RING KIT (T.4,00)</p> <p><b>OEM No :</b> 1499 298 003</p> <p><b>EX / CROSS :</b></p>	<p><b>Packaging Unit:</b> 1</p> <p><b>Model:</b> 16K 130 16K 160 16K 190 16S 112 16S 112/1 16S 130/1 16S 160 16S 160/1 16S 160A 16S 190 16S 190/1 16S 190A 16S 200 8S 190</p>
<p><b>T38987</b></p> 	<p><b>Description:</b> SPLIT RING KIT (T.4,60)</p> <p><b>OEM No :</b> 1499 298 023</p> <p><b>EX / CROSS :</b></p>	<p><b>Packaging Unit:</b> 1</p> <p><b>Model:</b> 16S 150 16S 151 16S 151 DAF 16S 151 HYU 16S 151 MAN 16S 151 RVI 16S 151 SNVI 16S 1620TD 16S 1621TD IT 16S 1625TD 16S 162TD IT 16S 181 16S 181 MAN 16S 1820TO 16S 1820TO KMZ 16S 1820TO RVI 16S 1821TO IT 16S 1822TO 16S 1825TO 16S 182TO IT 16S 1920TD 16S 1921TD IT 16S 1922TD 16S 220</p>
<p><b>T39086</b></p> 	<p><b>Description:</b> SPLIT RING KIT (T.4,70)</p> <p><b>OEM No :</b> 1499 298 024</p> <p><b>EX / CROSS :</b></p>	<p><b>Packaging Unit:</b> 1</p> <p><b>Model:</b> 16S 150 16S 151 16S 1620TD 16S 1621TD IT 16S 1625TD 16S 162TD IT 16S 181 16S 1820TO 16S 1821TO IT 16S 1822TO 16S 1825TO 16S 182TO IT 16S 1920TD 16S 1921TD IT 16S 1922TD 16S 220 16S 220A 16S 221 16S 2220TD 16S 2220TO 16S 2220TO IT 16S 2221TD IT 16S 2221TO IT 16S 222TD</p>
<p><b>T38988</b></p> 	<p><b>Description:</b> SPLIT RING KIT (T.4,80)</p> <p><b>OEM No :</b> 1499 298 025</p> <p><b>EX / CROSS :</b></p>	<p><b>Packaging Unit:</b> 1</p> <p><b>Model:</b> 16S 150 16S 151 16S 151 DAF 16S 151 HYU 16S 151 MAN 16S 151 RVI 16S 151 SNVI 16S 1620TD 16S 1621TD IT 16S 1625TD 16S 162TD IT 16S 181 16S 181 MAN 16S 1820TO 16S 1820TO KMZ 16S 1820TO RVI 16S 1821TO IT 16S 1822TO 16S 1825TO 16S 182TO IT 16S 1920TD 16S 1921TD IT 16S 1922TD 16S 220</p>



<p><b>T39085</b></p> 	<p><b>Description:</b> SPLIT RING KIT (T.4,90)</p> <p><b>OEM No :</b> 1499 298 026</p> <p><b>EX / CROSS :</b></p>	<p><b>Packaging Unit:</b> 1</p> <p><b>Model:</b></p> <ul style="list-style-type: none"> <li>16S 150</li> <li>16S 151</li> <li>16S 1620TD</li> <li>16S 1621TD IT</li> <li>16S 1625TD</li> <li>16S 162TD IT</li> <li>16S 181</li> <li>16S 1820TO</li> <li>16S 1821TO IT</li> <li>16S 1822TO</li> <li>16S 1825TO</li> <li>16S 182TO IT</li> <li>16S 1920TD</li> <li>16S 1921TD IT</li> <li>16S 1922TD</li> <li>16S 220</li> <li>16S 220A</li> <li>16S 221</li> <li>16S 2220TD</li> <li>16S 2220TO</li> <li>16S 2220TO IT</li> <li>16S 2221TD IT</li> <li>16S 2221TO IT</li> <li>16S 2222TD</li> </ul>
<p><b>T38989</b></p> 	<p><b>Description:</b> SPLIT RING KIT (T.5,00)</p> <p><b>OEM No :</b> 1499 298 027</p> <p><b>EX / CROSS :</b></p>	<p><b>Packaging Unit:</b> 1</p> <p><b>Model:</b></p> <ul style="list-style-type: none"> <li>16S 150</li> <li>16S 151</li> <li>16S 151 DAF</li> <li>16S 151 HYU</li> <li>16S 151 RVI</li> <li>16S 151 SNVI</li> <li>16S 1620TD</li> <li>16S 1621TD IT</li> <li>16S 1625TD</li> <li>16S 162TD IT</li> <li>16S 181</li> <li>16S 181 MAN</li> <li>16S 1820TO</li> <li>16S 1820TO KMZ</li> <li>16S 1820TO RVI</li> <li>16S 1821TO IT</li> <li>16S 1822TO</li> <li>16S 1825TO</li> <li>16S 182TD IT</li> <li>16S 1920TD</li> <li>16S 1921TD IT</li> <li>16S 1922TD</li> <li>16S 220</li> <li>16S 220A</li> </ul>
<p><b>T13440</b></p> 	<p><b>Description:</b> SPRING</p> <p><b>OEM No :</b> 0732 040 409</p> <p><b>EX / CROSS :</b></p>	<p><b>Packaging Unit:</b> 3</p> <p><b>Model:</b></p> <ul style="list-style-type: none"> <li>12AS 1210TO</li> <li>12AS 1220TD</li> <li>12AS 1420TD</li> <li>12AS 1420TO</li> <li>12AS 1620TO</li> <li>12S 2130TD</li> <li>12S 2131TD IT</li> <li>12S 2133TD</li> <li>12S 2330TD</li> <li>12S 2331TD IT</li> <li>12S 2333TD</li> <li>12S 233TD IT</li> <li>12S 2830TD</li> <li>12S 2831TD IT</li> <li>12S 2833TD</li> <li>12S 283TD IT</li> <li>16S 109</li> <li>16S 109 STR</li> <li>16S 112/1</li> <li>16S 130/1</li> <li>16S 150</li> <li>16S 151</li> <li>16S 151 DAF</li> <li>16S 151 HIN</li> </ul>
<p><b>T09068</b></p> 	<p><b>Description:</b> SPRING</p> <p><b>OEM No :</b> 0732 040 736</p> <p><b>EX / CROSS :</b></p>	<p><b>Packaging Unit:</b> 6</p> <p><b>Model:</b></p>
<p><b>T08941</b></p> 	<p><b>Description:</b> SPRING</p> <p><b>OEM No :</b> 0732 040 929</p> <p><b>EX / CROSS :</b> 0732 040 735</p>	<p><b>Packaging Unit:</b> 6</p> <p><b>Model:</b></p>



<p><b>T09501</b></p> 	<p><b>Description:</b> SPRING</p> <p><b>OEM No :</b> 1203 321 009</p> <p><b>EX / CROSS :</b></p>	<p><b>Packaging Unit:</b> 3</p> <p><b>Model:</b></p>																								
<p><b>T11828</b></p> 	<p><b>Description:</b> SPRING</p> <p><b>OEM No :</b> 0732 042 510</p> <p><b>EX / CROSS :</b></p>	<p><b>Packaging Unit:</b> 3</p> <p><b>Model:</b></p> <table border="0"> <tr> <td>5S 400V</td> <td>6S 500 TO</td> </tr> <tr> <td>6AS 1000TO</td> <td>6S 700BO</td> </tr> <tr> <td>6AS 1005TO</td> <td>6S 700BO KAVZ</td> </tr> <tr> <td>6AS 1010 BO</td> <td>6S 800TO</td> </tr> <tr> <td>6AS 1110BO</td> <td>6S 850</td> </tr> <tr> <td>6AS 700TO</td> <td>6S 850 DAF</td> </tr> <tr> <td>6AS 800TO</td> <td>6S 850 MAN</td> </tr> <tr> <td>6AS 805TO</td> <td>6S 890</td> </tr> <tr> <td>6S 1000TO</td> <td>AS Tronic</td> </tr> <tr> <td>6S 1000TO KMZ</td> <td>S5 47</td> </tr> <tr> <td>6S 1005TO</td> <td>S6 650</td> </tr> <tr> <td>6S 1010BO</td> <td></td> </tr> </table>	5S 400V	6S 500 TO	6AS 1000TO	6S 700BO	6AS 1005TO	6S 700BO KAVZ	6AS 1010 BO	6S 800TO	6AS 1110BO	6S 850	6AS 700TO	6S 850 DAF	6AS 800TO	6S 850 MAN	6AS 805TO	6S 890	6S 1000TO	AS Tronic	6S 1000TO KMZ	S5 47	6S 1005TO	S6 650	6S 1010BO	
5S 400V	6S 500 TO																									
6AS 1000TO	6S 700BO																									
6AS 1005TO	6S 700BO KAVZ																									
6AS 1010 BO	6S 800TO																									
6AS 1110BO	6S 850																									
6AS 700TO	6S 850 DAF																									
6AS 800TO	6S 850 MAN																									
6AS 805TO	6S 890																									
6S 1000TO	AS Tronic																									
6S 1000TO KMZ	S5 47																									
6S 1005TO	S6 650																									
6S 1010BO																										
<p><b>T08953</b></p> 	<p><b>Description:</b> SPRING</p> <p><b>OEM No :</b> 0732 040 497</p> <p><b>EX / CROSS :</b></p>	<p><b>Packaging Unit:</b> 3</p> <p><b>Model:</b></p>																								
<p><b>T09556</b></p> 	<p><b>Description:</b> SPRING</p> <p><b>OEM No :</b> 0732 041 571</p> <p><b>EX / CROSS :</b></p>	<p><b>Packaging Unit:</b> 3</p> <p><b>Model:</b></p> <table border="0"> <tr> <td>5S 600BO</td> </tr> <tr> <td>9S 75</td> </tr> <tr> <td>S5 42</td> </tr> <tr> <td>S5 42 KAVZ</td> </tr> <tr> <td>S5 42 KMZ</td> </tr> <tr> <td>S5 42 MAZ</td> </tr> <tr> <td>S5 42 SNVI</td> </tr> <tr> <td>S5 420</td> </tr> </table>	5S 600BO	9S 75	S5 42	S5 42 KAVZ	S5 42 KMZ	S5 42 MAZ	S5 42 SNVI	S5 420																
5S 600BO																										
9S 75																										
S5 42																										
S5 42 KAVZ																										
S5 42 KMZ																										
S5 42 MAZ																										
S5 42 SNVI																										
S5 420																										
<p><b>T57544</b></p> 	<p><b>Description:</b> SPRING</p> <p><b>OEM No :</b> 0732 042 766</p> <p><b>EX / CROSS :</b></p>	<p><b>Packaging Unit:</b> 1</p> <p><b>Model:</b></p> <table border="0"> <tr> <td>10AS 2010B IT</td> <td>12 TX 1415 TD IT (1372 001 026)</td> </tr> <tr> <td>10AS 2300BO</td> <td>12 TX 1610 TO IT (1372 002 025)</td> </tr> <tr> <td>10AS 2310B</td> <td>12 TX 1610 TO IT (1372 002 045)</td> </tr> <tr> <td>10AS 2310B IT</td> <td>12 TX 1611 BO IT (1372 044 006)</td> </tr> <tr> <td>10AS 2700BO</td> <td>12 TX 1611 BO IT (1372 044 033)</td> </tr> <tr> <td>12 TX 1410 TD IT (1372 001 023)</td> <td>12 TX 1611 BO IT (1372 044 050)</td> </tr> <tr> <td>12 TX 1410 TD IT (1372 001 030)</td> <td>12 TX 1611 BO IT (1372 044 051)</td> </tr> <tr> <td>12 TX 1410 TO (1372 002 019)</td> <td></td> </tr> <tr> <td>12 TX 1411 TD IT (1372 040 027)</td> <td></td> </tr> <tr> <td>12 TX 1411 TD IT (1372 040 028)</td> <td></td> </tr> </table>	10AS 2010B IT	12 TX 1415 TD IT (1372 001 026)	10AS 2300BO	12 TX 1610 TO IT (1372 002 025)	10AS 2310B	12 TX 1610 TO IT (1372 002 045)	10AS 2310B IT	12 TX 1611 BO IT (1372 044 006)	10AS 2700BO	12 TX 1611 BO IT (1372 044 033)	12 TX 1410 TD IT (1372 001 023)	12 TX 1611 BO IT (1372 044 050)	12 TX 1410 TD IT (1372 001 030)	12 TX 1611 BO IT (1372 044 051)	12 TX 1410 TO (1372 002 019)		12 TX 1411 TD IT (1372 040 027)		12 TX 1411 TD IT (1372 040 028)					
10AS 2010B IT	12 TX 1415 TD IT (1372 001 026)																									
10AS 2300BO	12 TX 1610 TO IT (1372 002 025)																									
10AS 2310B	12 TX 1610 TO IT (1372 002 045)																									
10AS 2310B IT	12 TX 1611 BO IT (1372 044 006)																									
10AS 2700BO	12 TX 1611 BO IT (1372 044 033)																									
12 TX 1410 TD IT (1372 001 023)	12 TX 1611 BO IT (1372 044 050)																									
12 TX 1410 TD IT (1372 001 030)	12 TX 1611 BO IT (1372 044 051)																									
12 TX 1410 TO (1372 002 019)																										
12 TX 1411 TD IT (1372 040 027)																										
12 TX 1411 TD IT (1372 040 028)																										





<p><b>T08951</b></p> 	<p><b>Description:</b> SPRING, INNER</p> <p><b>OEM No :</b> 0732 040 386</p> <p><b>EX / CROSS :</b></p>	<p><b>Packaging Unit:</b> 3</p> <p><b>Model:</b></p>																								
<p><b>T08950</b></p> 	<p><b>Description:</b> SPRING, OUTER</p> <p><b>OEM No :</b> 0732 040 385</p> <p><b>EX / CROSS :</b> 6001 301 056</p>	<p><b>Packaging Unit:</b> 3</p> <p><b>Model:</b></p>																								
<p><b>T57477</b></p> 	<p><b>Description:</b> SUN GEAR</p> <p><b>OEM No :</b> 1358 332 244</p> <p><b>EX / CROSS :</b> 1328 332 030 1358 332 247</p>	<p><b>Packaging Unit:</b> 1</p> <p><b>Model:</b></p> <table border="0"> <tr> <td>10AS 2010B IT</td> <td>12AS 1935TD</td> </tr> <tr> <td>10AS 2300BO</td> <td>12AS 2000B IT</td> </tr> <tr> <td>10AS 2310B</td> <td>12AS 2000BO</td> </tr> <tr> <td>10AS 2310B IT</td> <td>12AS 2001BO IT</td> </tr> <tr> <td>10AS 2700BO</td> <td>12AS 2130TD</td> </tr> <tr> <td>12AS 1601BO IT</td> <td>12AS 2130TO</td> </tr> <tr> <td>12AS 1630TD</td> <td>12AS 2131TD IT</td> </tr> <tr> <td>12AS 1631TD IT</td> <td>12AS 2131TO IT</td> </tr> <tr> <td>12AS 1930TD</td> <td>12AS 2140TD</td> </tr> <tr> <td>12AS 1930TO</td> <td>12AS 2300B IT</td> </tr> <tr> <td>12AS 1931TD IT</td> <td>12AS 2300BO</td> </tr> <tr> <td>12AS 1931TO IT</td> <td>12AS 2301</td> </tr> </table>	10AS 2010B IT	12AS 1935TD	10AS 2300BO	12AS 2000B IT	10AS 2310B	12AS 2000BO	10AS 2310B IT	12AS 2001BO IT	10AS 2700BO	12AS 2130TD	12AS 1601BO IT	12AS 2130TO	12AS 1630TD	12AS 2131TD IT	12AS 1631TD IT	12AS 2131TO IT	12AS 1930TD	12AS 2140TD	12AS 1930TO	12AS 2300B IT	12AS 1931TD IT	12AS 2300BO	12AS 1931TO IT	12AS 2301
10AS 2010B IT	12AS 1935TD																									
10AS 2300BO	12AS 2000B IT																									
10AS 2310B	12AS 2000BO																									
10AS 2310B IT	12AS 2001BO IT																									
10AS 2700BO	12AS 2130TD																									
12AS 1601BO IT	12AS 2130TO																									
12AS 1630TD	12AS 2131TD IT																									
12AS 1631TD IT	12AS 2131TO IT																									
12AS 1930TD	12AS 2140TD																									
12AS 1930TO	12AS 2300B IT																									
12AS 1931TD IT	12AS 2300BO																									
12AS 1931TO IT	12AS 2301																									
<p><b>T59009</b></p> 	<p><b>Description:</b> SUN GEAR</p> <p><b>OEM No :</b> 1304 304 588</p> <p><b>EX / CROSS :</b></p>	<p><b>Packaging Unit:</b> 1</p> <p><b>Model:</b></p> <table border="0"> <tr> <td>8S 180</td> </tr> <tr> <td>8S 2100</td> </tr> <tr> <td>8S 2100BD</td> </tr> <tr> <td>8S 2100BO</td> </tr> <tr> <td>8S 2101BD IT</td> </tr> <tr> <td>8S 2101BO IT</td> </tr> </table>	8S 180	8S 2100	8S 2100BD	8S 2100BO	8S 2101BD IT	8S 2101BO IT																		
8S 180																										
8S 2100																										
8S 2100BD																										
8S 2100BO																										
8S 2101BD IT																										
8S 2101BO IT																										
<p><b>T18576</b></p> 	<p><b>Description:</b> SUN GEAR (18-22T.)</p> <p><b>OEM No :</b> 4472 353 158</p> <p><b>EX / CROSS :</b> 4472 353 157</p>	<p><b>Packaging Unit:</b> 1</p> <p><b>Model:</b></p>																								







<p><b>T15359</b></p> 	<p><b>Description:</b> SUN GEAR (27T.)</p> <p><b>OEM No :</b> 1295 304 247</p> <p><b>EX / CROSS :</b></p> <p><b>Model:</b></p> <p><b>Packaging Unit:</b> 1</p>
<p><b>T46586</b></p> 	<p><b>Description:</b> SUN GEAR (27T.)</p> <p><b>OEM No :</b> 0091 304 194</p> <p><b>EX / CROSS :</b></p> <p><b>Model:</b> 16S 1650 16S 1650 MAZ</p> <p><b>Packaging Unit:</b> 1</p>
<p><b>T15377</b></p> 	<p><b>Description:</b> SUN GEAR (27T.)</p> <p><b>OEM No :</b> 1295 304 248</p> <p><b>EX / CROSS :</b></p> <p><b>Model:</b></p> <p><b>Packaging Unit:</b> 1</p>
<p><b>T15383</b></p> 	<p><b>Description:</b> SUN GEAR (27T.)</p> <p><b>OEM No :</b> 1297 304 187</p> <p><b>EX / CROSS :</b></p> <p><b>Model:</b></p> <p><b>Packaging Unit:</b> 1</p>
<p><b>T80341</b></p> 	<p><b>Description:</b> SUN GEAR (30T.)</p> <p><b>OEM No :</b> 1308 304 059</p> <p><b>EX / CROSS :</b></p> <p><b>Model:</b> 9S 75</p> <p><b>Packaging Unit:</b> 1</p>

<p><b>T74139</b></p> 	<p><b>Description:</b> SUN GEAR (34T.)</p> <p><b>OEM No :</b> 1304 304 448</p> <p><b>EX / CROSS :</b></p>	<p><b>Packaging Unit:</b> 1</p> <p><b>Model:</b> 8S 140 9S 109</p>
<p><b>T08842</b></p> 	<p><b>Description:</b> SUN GEAR (35T.)</p> <p><b>OEM No :</b> 1286 304 022</p> <p><b>EX / CROSS :</b> 1269 304 055</p>	<p><b>Packaging Unit:</b> 1</p> <p><b>Model:</b></p>
<p><b>T11970</b></p> 	<p><b>Description:</b> SUN GEAR (35T.)</p> <p><b>OEM No :</b> 1285 304 038</p> <p><b>EX / CROSS :</b> 1285 304 104</p>	<p><b>Packaging Unit:</b> 1</p> <p><b>Model:</b></p>
<p><b>T22235</b></p> 	<p><b>Description:</b> SUN GEAR (46T.)</p> <p><b>OEM No :</b> 1324 304 028</p> <p><b>EX / CROSS :</b> 1324 304 012</p>	<p><b>Packaging Unit:</b> 1</p> <p><b>Model:</b> 9S 1110TD 9S 1110TO 9S 1111TD IT 9S 1111TO IT 9S 1115TD 9S 1115TO 9S 1310TO 9S 1310TO KMZ 9S 1311TO IT 9S 1315TO</p>
<p><b>T53457</b></p> 	<p><b>Description:</b> SWITCH</p> <p><b>OEM No :</b> 0501 210 058</p> <p><b>EX / CROSS :</b> 0501 331 660</p>	<p><b>Packaging Unit:</b> 1</p> <p><b>Model:</b> 16S 2280TO 6AS 1005TO AS Tronic</p>

<p><b>T81270</b></p> 	<p><b>Description:</b> SYNCHRO CONE</p> <p><b>OEM No :</b> 1290 395 021</p> <p><b>EX / CROSS :</b></p> <p><b>Model:</b> S5 680 S5 680 SSO</p>	<p><b>Packaging Unit:</b> 1</p>
<p><b>T80344</b></p> 	<p><b>Description:</b> SYNCHRO CONE</p> <p><b>OEM No :</b> 1311 302 022</p> <p><b>EX / CROSS :</b></p> <p><b>Model:</b> 6AS 800TO 6AS 805TO 6S 800TO AS Tronic S6 85</p>	<p><b>Packaging Unit:</b> 1</p>
<p><b>T53982</b></p> 	<p><b>Description:</b> SYNCHRO CONE</p> <p><b>OEM No :</b> 1311 304 015</p> <p><b>EX / CROSS :</b> 1311 304 180</p> <p><b>Model:</b> 8S 180 8S 2100 8S 2100BD 8S 2100BO 8S 2101BD IT 8S 2101BO IT S6 66 S6 66+GV66 S6 85</p>	<p><b>Packaging Unit:</b> 1</p>
<p><b>T50154</b></p> 	<p><b>Description:</b> SYNCHRO CONE</p> <p><b>OEM No :</b> 0091 304 128</p> <p><b>EX / CROSS :</b></p> <p><b>Model:</b> 16S 1650</p>	<p><b>Packaging Unit:</b> 1</p>
<p><b>T22124</b></p> 	<p><b>Description:</b> SYNCHRO CONE</p> <p><b>OEM No :</b> 1307 304 628</p> <p><b>EX / CROSS :</b> 1307 395 088</p> <p><b>Model:</b> 5S 580 5S 600BO S5 42 S5 42 KAVZ S5 42 KMZ S5 42 MAZ S5 42 SNVI</p>	<p><b>Packaging Unit:</b> 1</p>

<p><b>T54731</b></p> 	<p><b>Description:</b> SYNCHRO CONE</p> <p><b>OEM No :</b> 0091 304 202</p> <p><b>EX / CROSS :</b> 1268 304 569</p>	<p><b>Packaging Unit:</b> 1</p> <p><b>Model:</b> S6 1550</p>
<p><b>T60313</b></p> 	<p><b>Description:</b> SYNCHRO CONE</p> <p><b>OEM No :</b> 1310 304 232</p> <p><b>EX / CROSS :</b></p>	<p><b>Packaging Unit:</b> 1</p> <p><b>Model:</b> 6S 1200TD 6S 1205TD 6S 1600BD 6S 1601BD IT 6S 1700BO 6S 1701BO IT 6S 1900BO 6S 1901BO IT</p>
<p><b>T50549</b></p> 	<p><b>Description:</b> SYNCHRO CONE</p> <p><b>OEM No :</b> 1310 302 045</p> <p><b>EX / CROSS :</b></p>	<p><b>Packaging Unit:</b> 1</p> <p><b>Model:</b> 6S 1350 BO 6S 1600 6S 1600BD 6S 1601BD IT 6S 1700BO 6S 1701BO IT 6S 1900BO 6S 1901BO IT</p>
<p><b>T22188</b></p> 	<p><b>Description:</b> SYNCHRO CONE</p> <p><b>OEM No :</b> 1290 304 509</p> <p><b>EX / CROSS :</b></p>	<p><b>Packaging Unit:</b> 1</p> <p><b>Model:</b> 6AS 700TO 6S 700BO 6S 700BO KAVZ 6S 850 6S 850 DAF 6S 850 MAN 6S 890 AS Tronic</p>
<p><b>T77281</b></p> 	<p><b>Description:</b> SYNCHRO CONE</p> <p><b>OEM No :</b> 1290 304 488</p> <p><b>EX / CROSS :</b></p>	<p><b>Packaging Unit:</b> 1</p> <p><b>Model:</b> 6S 850</p>

<p><b>T77297</b></p> 	<p><b>Description:</b> SYNCHRO CONE</p> <p><b>OEM No :</b> 1336 304 050</p> <p><b>EX / CROSS :</b></p> <p><b>Model:</b> 12AS 1210TO 12AS 1220TD 12AS 1420TD 12AS 1420TO 12AS 1620TO AS Tronic</p>	<p><b>Packaging Unit:</b> 1</p>
<p><b>T81271</b></p> 	<p><b>Description:</b> SYNCHRO CONE</p> <p><b>OEM No :</b> 1290 395 013</p> <p><b>EX / CROSS :</b></p> <p><b>Model:</b> S5 680 S5 680 SSO</p>	<p><b>Packaging Unit:</b> 1</p>
<p><b>T53403</b></p> 	<p><b>Description:</b> SYNCHRO CONE</p> <p><b>OEM No :</b> 0091 304 207</p> <p><b>EX / CROSS :</b></p> <p><b>Model:</b> 16S 1650</p>	<p><b>Packaging Unit:</b> 1</p>
<p><b>T63688</b></p> 	<p><b>Description:</b> SYNCHRO CONE</p> <p><b>OEM No :</b> 1310 304 161</p> <p><b>EX / CROSS :</b> 0091 302 152 1268 302 176</p> <p><b>Model:</b> 6S 1350 BO 6S 1600BD 6S 1601BD IT 6S 1700BO 6S 1701BO IT 6S 1900BO 6S 1901BO IT</p>	<p><b>Packaging Unit:</b> 1</p>
<p><b>T77349</b></p> 	<p><b>Description:</b> SYNCHRO CONE</p> <p><b>OEM No :</b> 1336 333 001</p> <p><b>EX / CROSS :</b></p> <p><b>Model:</b> 12AS 1210TO 12AS 1220TD 12AS 1420TD 12AS 1420TO 12AS 1620TO AS Tronic</p>	<p><b>Packaging Unit:</b> 1</p>



<p><b>T45797</b></p> 	<p><b>Description:</b> SYNCHRO CONE</p> <p><b>OEM No :</b> 1307 395 124</p> <p><b>EX / CROSS :</b> 1307 302 109 0091 302 208</p>	<p><b>Packaging Unit:</b> 1</p> <p><b>Model:</b></p>
<p><b>T54726</b></p> 	<p><b>Description:</b> SYNCHRO CONE</p> <p><b>OEM No :</b> 0091 304 062</p> <p><b>EX / CROSS :</b></p>	<p><b>Packaging Unit:</b> 1</p> <p><b>Model:</b> S6 1550</p>
<p><b>T22293</b></p> 	<p><b>Description:</b> SYNCHRO CONE</p> <p><b>OEM No :</b> 1316 304 154</p> <p><b>EX / CROSS :</b></p>	<p><b>Packaging Unit:</b> 1</p> <p><b>Model:</b> 16S 1650 16S 1650 MAZ 8S 1350 KMZ</p>
<p><b>T77355</b></p> 	<p><b>Description:</b> SYNCHRO CONE</p> <p><b>OEM No :</b> 1336 333 006</p> <p><b>EX / CROSS :</b> 1336 333 005</p>	<p><b>Packaging Unit:</b> 1</p> <p><b>Model:</b> 12AS 1210TO 12AS 1220TD 12AS 1420TD 12AS 1420TO 12AS 1620TO AS Tronic</p>
<p><b>T22175</b></p> 	<p><b>Description:</b> SYNCHRO CONE</p> <p><b>OEM No :</b> 1290 304 482</p> <p><b>EX / CROSS :</b> 1290 304 505</p>	<p><b>Packaging Unit:</b> 1</p> <p><b>Model:</b> 6AS 700TO 6AS 800TO 6AS 805TO 6S 700BO 6S 700BO KAVZ 6S 800TO 6S 850 6S 850 DAF 6S 850 MAN 6S 890 AS Tronic</p>

<p><b>T50174</b></p> 	<p><b>Description:</b> SYNCHRO CONE</p> <p><b>OEM No :</b> 1304 233 013</p> <p><b>EX / CROSS :</b> 1297 233 059</p> <p><b>Model:</b> 16S 109 8S 109 8S 180 8S 2100 8S 2100BD 8S 2100BO 9S 109</p>	<p><b>Packaging Unit:</b> 1</p>
<p><b>T93563</b></p> 	<p><b>Description:</b> SYNCHRO CONE</p> <p><b>OEM No :</b> 1307 395 192</p> <p><b>EX / CROSS :</b> 1307 304 574</p> <p><b>Model:</b> S5 420</p>	<p><b>Packaging Unit:</b> 1</p>
<p><b>T67105</b></p> 	<p><b>Description:</b> SYNCHRO CONE</p> <p><b>OEM No :</b> 1360 304 146</p> <p><b>EX / CROSS :</b></p> <p><b>Model:</b> 6S 1310 BD 6S 1310 BO 6S 1311 BD 6S 1311 BO</p>	<p><b>Packaging Unit:</b> 1</p>
<p><b>T57466</b></p> 	<p><b>Description:</b> SYNCHRO CONE</p> <p><b>OEM No :</b> 1328 333 009</p> <p><b>EX / CROSS :</b> 1328 333 004</p> <p><b>Model:</b> 10AS 2010B IT 10AS 2300BO 10AS 2310B 10AS 2310B IT 10AS 2700BO 12 TX 1410 TD IT (1372 001 023) 12 TX 1410 TD IT (1372 001 030) 12 TX 1410 TO (1372 002 019) 12 TX 1411 TD IT (1372 040 027) 12 TX 1411 TD IT (1372 040 222)</p> <p>12 TX 1415 TD IT (1372 001 026) 12 TX 1610 TO IT (1372 002 025) 12 TX 1610 TO IT (1372 002 045) 12 TX 1611 BO IT (1372 044 006) 12 TX 1611 BO IT (1372 044 033) 12 TX 1611 BO IT (1372 044 050) 12 TX 1611 BO IT (1372 044 254)</p>	<p><b>Packaging Unit:</b> 1</p>
<p><b>T55074</b></p> 	<p><b>Description:</b> SYNCHRO CONE</p> <p><b>OEM No :</b> 1304 304 660</p> <p><b>EX / CROSS :</b> 1304 304 056</p> <p><b>Model:</b> 6S 150C 8S 140 9S 109</p>	<p><b>Packaging Unit:</b> 1</p>



<p><b>T38890</b></p> 	<p><b>Description:</b> SYNCHRO CONE</p> <p><b>OEM No :</b> 1325 233 007</p> <p><b>EX / CROSS :</b> 1325 333 017</p>	<p><b>Packaging Unit:</b> 1</p> <p><b>Model:</b> 12S 2130TD 12S 2133TD 12S 2330TD 12S 2333TD 12S 2830TD 12S 2833TD 16S 1620TD 16S 1625TD 16S 1630TD 16S 1635TD 16S 1820TO 16S 1830TO 16S 1833TO 16S 1835TO 16S 1920TD 16S 1923TD 16S 1925TD 16S 1933TD 16S 1935TD 16S 2220TD 16S 2220TO 16S 2220TO IVE 16S 2223TD 16S 2223TO</p>
<p><b>T67103</b></p> 	<p><b>Description:</b> SYNCHRO CONE</p> <p><b>OEM No :</b> 1360 303 134</p> <p><b>EX / CROSS :</b></p>	<p><b>Packaging Unit:</b></p> <p><b>Model:</b> 6S 1310 BD 6S 1310 BO 6S 1311 BD 6S 1311 BO</p>
<p><b>T72403</b></p> 	<p><b>Description:</b> SYNCHRO CONE</p> <p><b>OEM No :</b> 1308 233 003</p> <p><b>EX / CROSS :</b> 1308 233 001</p>	<p><b>Packaging Unit:</b> 1</p> <p><b>Model:</b> 9S 75</p>
<p><b>T38930</b></p> 	<p><b>Description:</b> SYNCHRO CONE</p> <p><b>OEM No :</b> 1304 304 623</p> <p><b>EX / CROSS :</b></p>	<p><b>Packaging Unit:</b> 1</p> <p><b>Model:</b> 16S 109 6S 700BO 6S 850 6S 850 DAF 6S 850 MAN 6S 890 8S 109 9S 109 S5 680 S6 36 S6 680</p>
<p><b>T77099</b></p> 	<p><b>Description:</b> SYNCHRO CONE</p> <p><b>OEM No :</b> 1346 304 092</p> <p><b>EX / CROSS :</b></p>	<p><b>Packaging Unit:</b> 1</p> <p><b>Model:</b> 6S 1000TO 6S 800TO</p>



T44643



**Description:**  
SYNCHRO CONE

**Packaging Unit:** 1

**OEM No :**  
1295 304 278/M

**Model:**

**EX / CROSS :**

T55219



**Description:**  
SYNCHRO CONE

**Packaging Unit:** 1

**OEM No :**  
1290 395 134

**Model:**  
S5 680  
S5 680 SSO

**EX / CROSS :**

T72472



**Description:**  
SYNCHRO CONE

**Packaging Unit:** 1

**OEM No :**  
1328 333 010

**Model:**  
12AS 2302

**EX / CROSS :**  
1314 333 031

T11027



**Description:**  
SYNCHRO CONE (36-63T.)

**Packaging Unit:** 1

**OEM No :**  
1269 333 056

**Model:**

**EX / CROSS :**

T10171





**Description:**  
SYNCHRO CONE (36T.)

**Packaging Unit:** 1

**OEM No :**  
1238 304 383

**Model:**  
S5 35/2



**EX / CROSS :**  
1238 304 363

<p><b>T10176</b></p> 	<p><b>Description:</b> SYNCHRO CONE (36T.)</p> <p><b>OEM No :</b> 1290 302 023</p> <p><b>EX / CROSS :</b></p> <p><b>Model:</b> S6 36 S6 36+GV36 S6 36/2</p>	<p><b>Packaging Unit:</b> 1</p>
<p><b>T38279</b></p> 	<p><b>Description:</b> SYNCHRO CONE (45-48T.)</p> <p><b>OEM No :</b> 1304 304 012</p> <p><b>EX / CROSS :</b></p> <p><b>Model:</b> 16S 109 16S 109 STR 8S 109</p>	<p><b>Packaging Unit:</b> 1</p>
<p><b>T72418</b></p> 	<p><b>Description:</b> SYNCHRO CONE (48-27T.)</p> <p><b>OEM No :</b> 1310 302 024</p> <p><b>EX / CROSS :</b></p> <p><b>Model:</b> 6S 1000BD 6S 1200BD 6S 1200TD 6S 1205TD S6 85</p>	<p><b>Packaging Unit:</b> 1</p>
<p><b>T37959</b></p> 	<p><b>Description:</b> SYNCHRO CONE (48-38T.)</p> <p><b>OEM No :</b> 1311 304 009</p> <p><b>EX / CROSS :</b></p> <p><b>Model:</b> 6S 1000BD 6S 1000BO 6S 1200BD 6S 1200BO 6S 1200BO IKA 6S 1200BO KMZ 6S 1200TD 6S 1200TO 6S 1205TD S6 66 S6 66+GV66 S6 85</p>	<p><b>Packaging Unit:</b> 1</p> <p>S6 85 LIAZ S6 85 MAN S6 85 MAZ S6 85 NEFAZ</p>
<p><b>T38869</b></p> 	<p><b>Description:</b> SYNCHRO CONE (48-45T.)</p> <p><b>OEM No :</b> 1346 304 047</p> <p><b>EX / CROSS :</b></p> <p><b>Model:</b> 6AS 1000TO 6AS 1005TO 6AS 1010 BO 6AS 1110BO 6S 1000TO 6S 1005TO 6S 1010BO AS Tronic</p>	<p><b>Packaging Unit:</b> 1</p>



<p><b>T38271</b></p> 	<p><b>Description:</b> SYNCHRO CONE (48-48T.)</p> <p><b>OEM No :</b> 1304 302 188</p> <p><b>EX / CROSS :</b> 1304 302 006</p>	<p><b>Packaging Unit:</b> 1</p> <p><b>Model:</b> 16S 109 16S 109 STR</p>
<p><b>T20716</b></p> 	<p><b>Description:</b> SYNCHRO CONE (48T.)</p> <p><b>OEM No :</b> 1324 304 011</p> <p><b>EX / CROSS :</b></p>	<p><b>Packaging Unit:</b> 1</p> <p><b>Model:</b> 9S 1110TD 9S 1110TO 9S 1111TD IT 9S 1111TO IT 9S 1115TD 9S 1115TO 9S 1310TO 9S 1310TO KMZ 9S 1311TO IT 9S 1315TO</p>
<p><b>T19727</b></p> 	<p><b>Description:</b> SYNCHRO CONE (48T.)</p> <p><b>OEM No :</b> 1304 302 425</p> <p><b>EX / CROSS :</b> 1304 302 259</p>	<p><b>Packaging Unit:</b> 1</p> <p><b>Model:</b> 8S 180 8S 180 ENASA 8S 2100 8S 2100BD 8S 2100BO 8S 2101BD IT 8S 2101BO IT</p>
<p><b>T08530</b></p> 	<p><b>Description:</b> SYNCHRO CONE (48T.)</p> <p><b>OEM No :</b> 1250 312 366</p> <p><b>EX / CROSS :</b> 1250 312 087</p>	<p><b>Packaging Unit:</b> 1</p> <p><b>Model:</b></p>
<p><b>T37946</b></p> 	<p><b>Description:</b> SYNCHRO CONE (48T.)</p> <p><b>OEM No :</b> 1310 302 023</p> <p><b>EX / CROSS :</b></p>	<p><b>Packaging Unit:</b> 1</p> <p><b>Model:</b> 6AS 700TO 6AS 800TO 6AS 805TO 6S 1000BO 6S 1200BO 6S 1200BO IKA 6S 1200BO KMZ 6S 1200TO 6S 800TO AS Tronic S6 85 S6 85 LIAZ</p> <p>S6 85 MAN S6 85 NEFAZ</p>

<p><b>T08527</b></p> 	<p><b>Description:</b> SYNCHRO CONE (48T.)</p> <p><b>OEM No :</b> 1250 312 364</p> <p><b>EX / CROSS :</b> 1250 312 088</p>	<p><b>Packaging Unit:</b> 1</p> <p><b>Model:</b></p>
<p><b>T20711</b></p> 	<p><b>Description:</b> SYNCHRO CONE (48T.) W/OIL SEAL</p> <p><b>OEM No :</b> 1324 204 009</p> <p><b>EX / CROSS :</b></p>	<p><b>Packaging Unit:</b> 1</p> <p><b>Model:</b> 9S 1110TD 9S 1110TO 9S 1111TD IT 9S 1111TO IT 9S 1115TD 9S 1115TO 9S 1310TO 9S 1310TO KMZ 9S 1311TO IT 9S 1315TO</p>
<p><b>T53975</b></p> 	<p><b>Description:</b> SYNCHRO CONE (48T.) W/OIL SEAL</p> <p><b>OEM No :</b> 1304 202 214</p> <p><b>EX / CROSS :</b></p>	<p><b>Packaging Unit:</b> 1</p> <p><b>Model:</b> 8S 180 8S 2100 8S 2100BD 8S 2100BO 8S 2101BD IT 8S 2101BO IT</p>
<p><b>T14451</b></p> 	<p><b>Description:</b> SYNCHRO CONE (51-18T.)</p> <p><b>OEM No :</b> 1268 304 142</p> <p><b>EX / CROSS :</b></p>	<p><b>Packaging Unit:</b> 1</p> <p><b>Model:</b></p>
<p><b>T39076</b></p> 	<p><b>Description:</b> SYNCHRO CONE (51-48T.)</p> <p><b>OEM No :</b> 1346 304 093</p> <p><b>EX / CROSS :</b></p>	<p><b>Packaging Unit:</b> 1</p> <p><b>Model:</b> 6AS 1000TO 6AS 1005TO 6AS 1010 BO 6AS 1110BO 6S 1000TO 6S 1000TO KMZ 6S 1005TO 6S 1010BO AS Tronic</p>

<p><b>T38873</b></p> 	<p><b>Description:</b> SYNCHRO CONE (51-51T.)</p> <p><b>OEM No :</b> 1346 304 094</p> <p><b>EX / CROSS :</b></p>	<p><b>Packaging Unit:</b> 1</p> <p><b>Model:</b> 6AS 1000TO 6AS 1005TO 6AS 1010BO 6AS 1110BO 6AS 800TO 6AS 805TO 6S 1000TO 6S 1005TO 6S 1010BO AS Tronic</p>
<p><b>T08463</b></p> 	<p><b>Description:</b> SYNCHRO CONE (51T.)</p> <p><b>OEM No :</b> 1269 304 196</p> <p><b>EX / CROSS :</b></p>	<p><b>Packaging Unit:</b> 1</p> <p><b>Model:</b></p>
<p><b>T08861</b></p> 	<p><b>Description:</b> SYNCHRO CONE (51T.)</p> <p><b>OEM No :</b> 1269 304 137</p> <p><b>EX / CROSS :</b> 1269 302 138 1269 304 023</p>	<p><b>Packaging Unit:</b> 1</p> <p><b>Model:</b></p>
<p><b>T08479</b></p> 	<p><b>Description:</b> SYNCHRO CONE (51T.)</p> <p><b>OEM No :</b> 1272 304 136</p> <p><b>EX / CROSS :</b> 1250 302 202 1250 302 242 1250 304 389</p>	<p><b>Packaging Unit:</b> 1</p> <p><b>Model:</b></p>
<p><b>T09051</b></p> 	<p><b>Description:</b> SYNCHRO CONE (51T.)</p> <p><b>OEM No :</b> 1268 304 537</p> <p><b>EX / CROSS :</b></p>	<p><b>Packaging Unit:</b> 1</p> <p><b>Model:</b> S6 90 S6 90 SETRA S6 90+GV90</p>



<p><b>T08451</b></p> 	<p><b>Description:</b> SYNCHRO CONE (51T.)</p> <p><b>OEM No :</b> 1250 304 351</p> <p><b>EX / CROSS :</b> 1250 304 312 1250 304 165 1250 204 072</p>	<p><b>Packaging Unit:</b> 1</p> <p><b>Model:</b></p>
<p><b>T09052</b></p> 	<p><b>Description:</b> SYNCHRO CONE (51T.)</p> <p><b>OEM No :</b> 1268 304 538</p> <p><b>EX / CROSS :</b></p>	<p><b>Packaging Unit:</b> 1</p> <p><b>Model:</b> S6 90 S6 90 SETRA S6 90+GV90</p>
<p><b>T20867</b></p> 	<p><b>Description:</b> SYNCHRO CONE (51T.)</p> <p><b>OEM No :</b> 1324 304 013</p> <p><b>EX / CROSS :</b></p>	<p><b>Packaging Unit:</b> 1</p> <p><b>Model:</b> 9S 1110TD 9S 1110TO 9S 1111TD IT 9S 1111TO IT 9S 1115TD 9S 1115TO 9S 1310TO 9S 1310TO KMZ 9S 1311TO IT 9S 1315TO</p>
<p><b>T08559</b></p> 	<p><b>Description:</b> SYNCHRO CONE (51T.)</p> <p><b>OEM No :</b> 1250 304 292</p> <p><b>EX / CROSS :</b> 1250 304 228 1250 304 352</p>	<p><b>Packaging Unit:</b> 1</p> <p><b>Model:</b></p>
<p><b>T08476</b></p> 	<p><b>Description:</b> SYNCHRO CONE (51T.)</p> <p><b>OEM No :</b> 1285 333 021</p> <p><b>EX / CROSS :</b> 1285 333 004 1285 333 018</p>	<p><b>Packaging Unit:</b> 1</p> <p><b>Model:</b></p>



<p><b>T19786</b></p> 	<p><b>Description:</b> SYNCHRO CONE (51T.)</p> <p><b>OEM No :</b> 1304 304 408</p> <p><b>EX / CROSS :</b> 1304 304 076</p> <p><b>Model:</b> 16S 109 16S 109 STR 6S 150C 8S 109 8S 140 9S 109 9S 109 MAN 9S 109 SNVI</p>	<p><b>Packaging Unit:</b> 1</p>
<p><b>T12197</b></p> 	<p><b>Description:</b> SYNCHRO CONE (51T.)</p> <p><b>OEM No :</b> (1299 304 875)</p> <p><b>EX / CROSS :</b></p>	<p><b>Packaging Unit:</b> 1</p>
<p><b>T12198</b></p> 	<p><b>Description:</b> SYNCHRO CONE (51T.)</p> <p><b>OEM No :</b> (1299 304 882)</p> <p><b>EX / CROSS :</b></p>	<p><b>Packaging Unit:</b> 1</p>
<p><b>T22183</b></p> 	<p><b>Description:</b> SYNCHRO CONE (54-44T.)</p> <p><b>OEM No :</b> 1290 304 508</p> <p><b>EX / CROSS :</b></p>	<p><b>Packaging Unit:</b> 1</p> <p><b>Model:</b> 6AS 700TO 6S 700BO 6S 700BO KAVZ 6S 850 6S 850 DAF 6S 850 MAN 6S 890 AS Tronic</p>
<p><b>T22284</b></p> 	<p><b>Description:</b> SYNCHRO CONE (57-30T.) (CARBON FIBER)</p> <p><b>OEM No :</b> 1356 304 025</p> <p><b>EX / CROSS :</b> 1316 304 218</p>	<p><b>Packaging Unit:</b> 1</p> <p><b>Model:</b> 16S 1620TD 16S 1621TD IT 16S 1625TD 16S 162TD IT 16S 1630TD 16S 1631TD IT 16S 1635TD 16S 163TD IT 16S 1820TO 16S 1820TO RVI 16S 1821TO IT 16S 1822TO 16S 1825TO 16S 182TO IT 16S 1830TO 16S 1831TO IT 16S 1833TO 16S 1835TO 16S 183TO IT 16S 1920TD 16S 1921TD IT 16S 1922TD 16S 1923TD 16S 1925TD</p>



<p><b>T22279</b></p> 	<p><b>Description:</b> SYNCHRO CONE (57-30T.) (MOLYBDENUM)</p> <p><b>Packaging Unit:</b> 1</p> <p><b>OEM No :</b> 1316 304 190 <b>EX / CROSS :</b> 1316 304 201 1356 304 025/M</p> <p><b>Model:</b> 12S 2130TD 12S 2131TD IT 12S 2133TD 12S 2330TD 12S 2331TD IT 12S 2333TD 12S 2333TD IT 12S 2830TD 12S 2831TD IT 12S 2833TD 12S 283TD IT 16S 150 16S 151 16S 151PTO HIN 16S 1620TD 16S 1621TD IT 16S 1625TD 16S 162TD IT 16S 1630TD 16S 1631TD IT 16S 1635TD 16S 163TD IT 16S 181 16S 1820TO</p>
<p><b>T08871</b></p> 	<p><b>Description:</b> SYNCHRO CONE (57-58T.)</p> <p><b>Packaging Unit:</b> 1</p> <p><b>OEM No :</b> 1295 304 278 <b>EX / CROSS :</b> 1295 304 294 1297 304 041</p> <p><b>Model:</b></p>
<p><b>T22295</b></p> 	<p><b>Description:</b> SYNCHRO CONE (57-58T.)</p> <p><b>Packaging Unit:</b> 1</p> <p><b>OEM No :</b> 1316 304 185 <b>EX / CROSS :</b></p> <p><b>Model:</b> 16S 1650 IVE</p>
<p><b>T08858</b></p> 	<p><b>Description:</b> SYNCHRO CONE (57T.- 61SPL.)</p> <p><b>Packaging Unit:</b> 1</p> <p><b>OEM No :</b> 1295 304 165 <b>EX / CROSS :</b></p> <p><b>Model:</b></p>
<p><b>T17867</b></p> 	<p><b>Description:</b> SYNCHRO CONE (57T.)</p> <p><b>Packaging Unit:</b> 1</p> <p><b>OEM No :</b> 1316 304 159 <b>EX / CROSS :</b> 1316 304 145</p> <p><b>Model:</b> 16S 150 16S 151 16S 151 DAF 16S 151 HIN 16S 151 HYU 16S 151 IVE 16S 151 KMZ 16S 151 MAN 16S 151 RVI 16S 151 SNVI 16S 151IT DAF 16S 151PTO HIN 16S 1685 16S 181 16S 181 IVE 16S 181 MAN 16S 181 RVI 16S 181IT DAF 16S 1820TO KMZ 16S 1920TD 16S 1921TD IT 16S 1922TD 16S 1923TD 16S 220</p>

<p><b>T16723</b></p> 	<p><b>Description:</b> SYNCHRO CONE (57T.)</p> <p><b>OEM No :</b> 1297 304 369</p> <p><b>EX / CROSS :</b></p>	<p><b>Packaging Unit:</b> 1</p> <p><b>Model:</b> 16S 112/1 16S 130/1 16S 160/1 16S 160A/1 16S 190/1 16S 190A/1</p>
<p><b>T11729</b></p> 	<p><b>Description:</b> SYNCHRO CONE (57T.)</p> <p><b>OEM No :</b> 1312 304 027</p> <p><b>EX / CROSS :</b> 1310 304 108</p>	<p><b>Packaging Unit:</b> 1</p> <p><b>Model:</b> 16S 150 16S 151 16S 151 DAF 16S 151 HIN 16S 151 HYU 16S 151 IVE 16S 151 KMZ 16S 151 MAN 16S 151 RVI 16S 151 SNVI 16S 151IT DAF 16S 151PTO HIN 16S 1620TD 16S 1621TD IT 16S 1625TD 16S 162TD IT 16S 1685 16S 181 16S 181 IVE 16S 181 MAN 16S 181 RVI 16S 181IT DAF 16S 182 16S 1820TO</p>
<p><b>T15103</b></p> 	<p><b>Description:</b> SYNCHRO CONE (57T.)</p> <p><b>OEM No :</b> 1312 304 056</p> <p><b>EX / CROSS :</b></p>	<p><b>Packaging Unit:</b> 1</p> <p><b>Model:</b> 16S 150 16S 151 16S 151 DAF 16S 151 HIN 16S 151 HYU 16S 151 KMZ 16S 151 MAN 16S 151 RVI 16S 151 SNVI 16S 151IT DAF 16S 181 16S 181 MAN 16S 181 RVI 16S 181IT DAF 16S 182 16S 220 16S 220A 16S 221 16S 221 DAF 16S 221 IVE 16S 221 MAN 16S 221 MB 16S 221 RVI</p>
<p><b>T20895</b></p> 	<p><b>Description:</b> SYNCHRO CONE (57T.)</p> <p><b>OEM No :</b> 0091 304 310</p> <p><b>EX / CROSS :</b> 1316 304 186-OLD</p>	<p><b>Packaging Unit:</b> 1</p> <p><b>Model:</b> 16S 1650 16S 1650 MAZ 8S 1350 KMZ</p>
<p><b>T20899</b></p> 	<p><b>Description:</b> SYNCHRO CONE (57T.)</p> <p><b>OEM No :</b> 0091 304 311</p> <p><b>EX / CROSS :</b> 0091 304 109 1316 304 187</p>	<p><b>Packaging Unit:</b> 1</p> <p><b>Model:</b> 16S 1650 16S 1650 MAZ 8S 1350 KMZ</p>

<p><b>T59073</b></p> 	<p><b>Description:</b> SYNCHRO CONE (60-34T.)</p> <p><b>OEM No :</b> 1304 332 075</p> <p><b>EX / CROSS :</b></p> <p><b>Model:</b> 16S 109 6S 150C 8S 109 8S 140 8S 180 9S 109</p>	<p><b>Packaging Unit:</b> 1</p>
<p><b>T22117</b></p> 	<p><b>Description:</b> SYNCHRO CONE (60-41T.)</p> <p><b>OEM No :</b> 1307 304 626</p> <p><b>EX / CROSS :</b> 1307 304 451 1307 395 089</p> <p><b>Model:</b> 5S 580 5S 600BO S5 42 S5 42 KAVZ S5 42 KMZ S5 42 MAZ S5 42 SNVI</p>	<p><b>Packaging Unit:</b> 1</p>
<p><b>T12138</b></p> 	<p><b>Description:</b> SYNCHRO CONE (60T.)</p> <p><b>OEM No :</b> 1308 304 078</p> <p><b>EX / CROSS :</b></p> <p><b>Model:</b></p>	<p><b>Packaging Unit:</b> 1</p>
<p><b>T22285</b></p> 	<p><b>Description:</b> SYNCHRO CONE (63-30T.) (CARBON FIBER)</p> <p><b>OEM No :</b> 1356 304 026</p> <p><b>EX / CROSS :</b></p> <p><b>Model:</b> 16S 1620TD 16S 1621TD IT 16S 162TD IT 16S 1630TD 16S 1631TD IT 16S 1635TD 16S 163TD IT 16S 1820TO 16S 1820TO RVI 16S 1821TO IT 16S 1822TO 16S 1823TO</p>	<p><b>Packaging Unit:</b> 1</p> <p>16S 1825TO 16S 182TO IT 16S 1830TO 16S 1831TO IT 16S 1833TO 16S 1835TO 16S 183TO IT 16S 1920TD 16S 1921TD IT 16S 1922TD 16S 1923TD 16S 1925TD</p>
<p><b>T15934</b></p> 	<p><b>Description:</b> SYNCHRO CONE (63-44T.)</p> <p><b>OEM No :</b> 1297 233 056</p> <p><b>EX / CROSS :</b></p> <p><b>Model:</b></p>	<p><b>Packaging Unit:</b> 1</p>





<p><b>T18042</b></p> 	<p><b>Description:</b> SYNCHRO CONE (63-58T.)</p> <p><b>OEM No :</b> 1296 333 050</p> <p><b>EX / CROSS :</b> 1316 333 009</p>	<p><b>Packaging Unit:</b> 1</p> <p><b>Model:</b></p> <table border="0"> <tr><td>12S 2130TD</td><td>16S 151 DAF</td></tr> <tr><td>12S 2131TD IT</td><td>16S 151 HIN</td></tr> <tr><td>12S 2133TD</td><td>16S 151 HYU</td></tr> <tr><td>12S 2330TD</td><td>16S 151 IVE</td></tr> <tr><td>12S 2331TD IT</td><td>16S 151 KMZ</td></tr> <tr><td>12S 2333TD</td><td>16S 151 MAN</td></tr> <tr><td>12S 2333TD IT</td><td>16S 151 RVI</td></tr> <tr><td>12S 2830TD</td><td>16S 151PTO HIN</td></tr> <tr><td>12S 2831TD IT</td><td>16S 1620TD</td></tr> <tr><td>12S 2833TD</td><td>16S 1621TD IT</td></tr> <tr><td>12S 283TD IT</td><td>16S 1625TD</td></tr> <tr><td>16S 151</td><td>16S 162TD IT</td></tr> </table>	12S 2130TD	16S 151 DAF	12S 2131TD IT	16S 151 HIN	12S 2133TD	16S 151 HYU	12S 2330TD	16S 151 IVE	12S 2331TD IT	16S 151 KMZ	12S 2333TD	16S 151 MAN	12S 2333TD IT	16S 151 RVI	12S 2830TD	16S 151PTO HIN	12S 2831TD IT	16S 1620TD	12S 2833TD	16S 1621TD IT	12S 283TD IT	16S 1625TD	16S 151	16S 162TD IT
12S 2130TD	16S 151 DAF																									
12S 2131TD IT	16S 151 HIN																									
12S 2133TD	16S 151 HYU																									
12S 2330TD	16S 151 IVE																									
12S 2331TD IT	16S 151 KMZ																									
12S 2333TD	16S 151 MAN																									
12S 2333TD IT	16S 151 RVI																									
12S 2830TD	16S 151PTO HIN																									
12S 2831TD IT	16S 1620TD																									
12S 2833TD	16S 1621TD IT																									
12S 283TD IT	16S 1625TD																									
16S 151	16S 162TD IT																									
<p><b>T22294</b></p> 	<p><b>Description:</b> SYNCHRO CONE (63-58T.)</p> <p><b>OEM No :</b> 1316 304 183</p> <p><b>EX / CROSS :</b></p>	<p><b>Packaging Unit:</b> 1</p> <p><b>Model:</b> 16S 1650 IVE</p>																								
<p><b>T08449</b></p> 	<p><b>Description:</b> SYNCHRO CONE (63T.)</p> <p><b>OEM No :</b> 1250 304 350</p> <p><b>EX / CROSS :</b> 1250 304 101</p>	<p><b>Packaging Unit:</b> 1</p> <p><b>Model:</b></p>																								
<p><b>T08474</b></p> 	<p><b>Description:</b> SYNCHRO CONE (63T.)</p> <p><b>OEM No :</b> 1269 333 048</p> <p><b>EX / CROSS :</b> 1269 333 011 1269 333 025 1269 333 045</p>	<p><b>Packaging Unit:</b> 1</p> <p><b>Model:</b></p>																								
<p><b>T09063</b></p> 	<p><b>Description:</b> SYNCHRO CONE (63T.)</p> <p><b>OEM No :</b> 1295 233 025</p> <p><b>EX / CROSS :</b> 1295 233 018 1295 233 024 1295 233 031</p>	<p><b>Packaging Unit:</b> 1</p> <p><b>Model:</b></p>																								

<p><b>T16726</b></p> 	<p><b>Description:</b> SYNCHRO CONE (63T.)</p> <p><b>OEM No :</b> 1297 304 371</p> <p><b>EX / CROSS :</b></p> <p><b>Model:</b> 16S 112/1 16S 130/1 16S 160/1 16S 160A/1 16S 190/1 16S 190A/1</p>	<p><b>Packaging Unit:</b> 1</p>
<p><b>T15090</b></p> 	<p><b>Description:</b> SYNCHRO CONE (63T.)</p> <p><b>OEM No :</b> 1312 304 106</p> <p><b>EX / CROSS :</b></p> <p><b>Model:</b></p>	<p><b>Packaging Unit:</b> 1</p>
<p><b>T14809</b></p> 	<p><b>Description:</b> SYNCHRO CONE (63T.)</p> <p><b>OEM No :</b> 1313 233 001</p> <p><b>EX / CROSS :</b> 1297 233 057 1297 233 042 1297 233 018</p> <p><b>Model:</b></p>	<p><b>Packaging Unit:</b> 1</p>
<p><b>T20866</b></p> 	<p><b>Description:</b> SYNCHRO CONE (63T.)</p> <p><b>OEM No :</b> 1324 233 001</p> <p><b>EX / CROSS :</b> 1324 333 019</p> <p><b>Model:</b> 16S 109 9S 1110TD 9S 1110TO 9S 1115TD 9S 1115TO 9S 1310TO 9S 1310TO KMZ 9S 1315TO</p>	<p><b>Packaging Unit:</b> 1</p>
<p><b>T15940</b></p> 	<p><b>Description:</b> SYNCHRO CONE (63T.)</p> <p><b>OEM No :</b> 1316 233 015</p> <p><b>EX / CROSS :</b> 1316 233 029</p> <p><b>Model:</b> 16S 151 16S 151 DAF 16S 151 HIN 16S 151 HYU 16S 151 KMZ 16S 151 MAN 16S 151 RVI 16S 1685 16S 181 16S 181 MAN 16S 181 RVI 16S 182</p>	<p><b>Packaging Unit:</b> 1</p> <p>16S 221 16S 221 DAF 16S 221 MAN 16S 2280TO 16S 251 16S 251 NIS 16S 2520TO MAN 16S 2723TO 16S 2725TO 8S 151 DAF Ecosplit III</p>





<p><b>T09054</b></p> 	<p><b>Description:</b> SYNCHRO CONE (63T.)</p> <p><b>OEM No :</b> 1297 304 196</p> <p><b>EX / CROSS :</b></p>	<p><b>Packaging Unit:</b> 1</p> <p><b>Model:</b></p>
<p><b>T18035</b></p> 	<p><b>Description:</b> SYNCHRO CONE (63T.)</p> <p><b>OEM No :</b> 1313 304 009</p> <p><b>EX / CROSS :</b></p>	<p><b>Packaging Unit:</b> 1</p> <p><b>Model:</b> 16S 150 16S 151 16S 181 16S 182 16S 220 16S 221 16S 251 6S 1600 6S 1600 KMZ 6S 1600BD 6S 1601BD IT 6S 1700BO 6S 1701BO IT 6S 1701BO XAM 6S 1900BO 6S 1900BO HYU 6S 1901BO IT Ecosplit III</p>
<p><b>T17866</b></p> 	<p><b>Description:</b> SYNCHRO CONE (63T.) (MOLYBDENUM)</p> <p><b>OEM No :</b> 1316 304 156</p> <p><b>EX / CROSS :</b> 1316 304 146 1356 304 026/M</p>	<p><b>Packaging Unit:</b> 1</p> <p><b>Model:</b> 16S 150 16S 151 16S 151 HYU 16S 151 IVE 16S 1620TD 16S 1621TD IT 16S 1625TD 16S 162TD IT 16S 1630TD 16S 1631TD IT 16S 163TD IT 16S 1685 16S 181 16S 181 IVE 16S 181 MAN 16S 1820TO 16S 1821TO IT 16S 1822TO 16S 1823TO 16S 1825TO 16S 182TD IT 16S 1833TO 16S 1920TD 16S 1921TD IT</p>
<p><b>T08869</b></p> 	<p><b>Description:</b> SYNCHRO CONE W/FLANGE (51T.)</p> <p><b>OEM No :</b> 1285 233 007</p> <p><b>EX / CROSS :</b> 1285 233 003 1285 233 006 1285 233 012 1285 333 033</p>	<p><b>Packaging Unit:</b> 1</p> <p><b>Model:</b></p>
<p><b>T11732</b></p> 	<p><b>Description:</b> SYNCHRO CONE W/FLANGE (63T.)</p> <p><b>OEM No :</b> 1315 233 006</p> <p><b>EX / CROSS :</b> 1296 333 024</p>	<p><b>Packaging Unit:</b> 1</p> <p><b>Model:</b> 16S 151 16S 151 SNVI 16S 151IT DAF 16S 221 16S 221 IVE 16S 221 MB 16S 221 RVI 16S 221 VW 16S 221IT IVE 16S 2520TO 16S 252TO IT 8S 151 8S 221 Ecosplit III</p>

<p><b>T11029</b></p> 	<p><b>Description:</b> SYNCHRO CONE W/FLANGE (63T.)</p> <p><b>Packaging Unit:</b> 1</p> <p><b>OEM No :</b> 1269 233 012</p> <p><b>Model:</b></p> <p><b>EX / CROSS :</b></p>
<p><b>T19778</b></p> 	<p><b>Description:</b> SYNCHRO CONE W/FLANGE (63T.)</p> <p><b>Packaging Unit:</b> 1</p> <p><b>OEM No :</b> 1304 233 006</p> <p><b>Model:</b> 16S 109 8S 109 8S 140 8S 180 8S 2100 8S 2100BD 8S 2100BO 8S 2101BD IT 8S 2101BO IT 9S 109 9S 1110TD 9S 1110TO</p> <p><b>EX / CROSS :</b> 1304 233 011 1324 233 006</p> <p>9S 1111TD IT 9S 1111TO IT 9S 1115TD 9S 1115TO 9S 1310TO 9S 1310TO KMZ 9S 1311TO IT 9S 1315TO</p>
<p><b>T08872</b></p> 	<p><b>Description:</b> SYNCHRO CONE W/FLANGE (63T.)</p> <p><b>Packaging Unit:</b> 1</p> <p><b>OEM No :</b> 1269 233 010</p> <p><b>Model:</b></p> <p><b>EX / CROSS :</b> 1269 233 002 1269 233 009</p>
<p><b>T08908</b></p> 	<p><b>Description:</b> SYNCHRO CONE W/FLANGE (63T.)</p> <p><b>Packaging Unit:</b> 1</p> <p><b>OEM No :</b> 1296 233 008</p> <p><b>Model:</b></p> <p><b>EX / CROSS :</b> 1296 233 006 1296 333 007 1296 233 005 1295 233 029</p>
<p><b>T12132</b></p> 	<p><b>Description:</b> SYNCHRO HUB</p> <p><b>Packaging Unit:</b> 1</p> <p><b>OEM No :</b> 1308 304 110</p> <p><b>Model:</b></p> <p><b>EX / CROSS :</b> 1308 304 065 1307 304 608 1307 304 166 1307 304 149</p>





<p><b>T15397</b></p> 	<p><b>Description:</b> SYNCHRO HUB</p> <p><b>OEM No :</b> 1272 304 124</p> <p><b>EX / CROSS :</b> 1250 304 124</p>	<p><b>Packaging Unit:</b> 1</p> <p><b>Model:</b></p>																								
<p><b>T37729</b></p> 	<p><b>Description:</b> SYNCHRO HUB</p> <p><b>OEM No :</b> 1328 302 064</p> <p><b>EX / CROSS :</b></p>	<p><b>Packaging Unit:</b> 1</p> <p><b>Model:</b></p> <table border="0"> <tr> <td>10AS 2010B IT</td> <td>12AS 1935TD</td> </tr> <tr> <td>10AS 2300BO</td> <td>12AS 2000B IT</td> </tr> <tr> <td>10AS 2310B</td> <td>12AS 2000BO</td> </tr> <tr> <td>10AS 2310B IT</td> <td>12AS 2001BO IT</td> </tr> <tr> <td>10AS 2700BO</td> <td>12AS 2130TD</td> </tr> <tr> <td>12AS 1601BO IT</td> <td>12AS 2130TO</td> </tr> <tr> <td>12AS 1630TD</td> <td>12AS 2131TD IT</td> </tr> <tr> <td>12AS 1631TD IT</td> <td>12AS 2131TO IT</td> </tr> <tr> <td>12AS 1930TD</td> <td>12AS 2140TD</td> </tr> <tr> <td>12AS 1930TO</td> <td>12AS 2300B IT</td> </tr> <tr> <td>12AS 1931TD IT</td> <td>12AS 2300BO</td> </tr> <tr> <td>12AS 1931TO IT</td> <td>12AS 2301</td> </tr> </table>	10AS 2010B IT	12AS 1935TD	10AS 2300BO	12AS 2000B IT	10AS 2310B	12AS 2000BO	10AS 2310B IT	12AS 2001BO IT	10AS 2700BO	12AS 2130TD	12AS 1601BO IT	12AS 2130TO	12AS 1630TD	12AS 2131TD IT	12AS 1631TD IT	12AS 2131TO IT	12AS 1930TD	12AS 2140TD	12AS 1930TO	12AS 2300B IT	12AS 1931TD IT	12AS 2300BO	12AS 1931TO IT	12AS 2301
10AS 2010B IT	12AS 1935TD																									
10AS 2300BO	12AS 2000B IT																									
10AS 2310B	12AS 2000BO																									
10AS 2310B IT	12AS 2001BO IT																									
10AS 2700BO	12AS 2130TD																									
12AS 1601BO IT	12AS 2130TO																									
12AS 1630TD	12AS 2131TD IT																									
12AS 1631TD IT	12AS 2131TO IT																									
12AS 1930TD	12AS 2140TD																									
12AS 1930TO	12AS 2300B IT																									
12AS 1931TD IT	12AS 2300BO																									
12AS 1931TO IT	12AS 2301																									
<p><b>T22317</b></p> 	<p><b>Description:</b> SYNCHRO HUB</p> <p><b>OEM No :</b> 1324 304 052</p> <p><b>EX / CROSS :</b> 1304 304 591</p>	<p><b>Packaging Unit:</b> 1</p> <p><b>Model:</b></p> <table border="0"> <tr><td>6S 150C</td></tr> <tr><td>8S 140</td></tr> <tr><td>9S 109</td></tr> <tr><td>9S 1110TD</td></tr> <tr><td>9S 1110TO</td></tr> <tr><td>9S 1111TD IT</td></tr> <tr><td>9S 1111TO IT</td></tr> <tr><td>9S 1115TD</td></tr> <tr><td>9S 1115TO</td></tr> <tr><td>9S 1310TO</td></tr> <tr><td>9S 1311TO IT</td></tr> <tr><td>9S 1315TO</td></tr> </table>	6S 150C	8S 140	9S 109	9S 1110TD	9S 1110TO	9S 1111TD IT	9S 1111TO IT	9S 1115TD	9S 1115TO	9S 1310TO	9S 1311TO IT	9S 1315TO												
6S 150C																										
8S 140																										
9S 109																										
9S 1110TD																										
9S 1110TO																										
9S 1111TD IT																										
9S 1111TO IT																										
9S 1115TD																										
9S 1115TO																										
9S 1310TO																										
9S 1311TO IT																										
9S 1315TO																										
<p><b>T67106</b></p> 	<p><b>Description:</b> SYNCHRO HUB</p> <p><b>OEM No :</b> 1360 304 191</p> <p><b>EX / CROSS :</b></p>	<p><b>Packaging Unit:</b> 1</p> <p><b>Model:</b></p> <table border="0"> <tr><td>6S 1310 BD</td></tr> <tr><td>6S 1310 BO</td></tr> <tr><td>6S 1311 BD</td></tr> <tr><td>6S 1311 BO</td></tr> </table>	6S 1310 BD	6S 1310 BO	6S 1311 BD	6S 1311 BO																				
6S 1310 BD																										
6S 1310 BO																										
6S 1311 BD																										
6S 1311 BO																										
<p><b>T09047</b></p> 	<p><b>Description:</b> SYNCHRO HUB</p> <p><b>OEM No :</b> 1268 304 143</p> <p><b>EX / CROSS :</b></p>	<p><b>Packaging Unit:</b> 1</p> <p><b>Model:</b></p> <table border="0"> <tr><td>S6 90</td></tr> <tr><td>S6 90 SETRA</td></tr> <tr><td>S6 90+GV90</td></tr> </table>	S6 90	S6 90 SETRA	S6 90+GV90																					
S6 90																										
S6 90 SETRA																										
S6 90+GV90																										







<p><b>T77380</b></p> 	<p><b>Description:</b> SYNCHRO HUB</p> <p><b>OEM No :</b> 1336 304 017</p> <p><b>EX / CROSS :</b></p> <p><b>Model:</b> 12AS 1210TO 12AS 1220TD 12AS 1420TD 12AS 1420TO 12AS 1620TO AS Tronic</p>	<p><b>Packaging Unit:</b> 1</p>
<p><b>T63695</b></p> 	<p><b>Description:</b> SYNCHRO HUB</p> <p><b>OEM No :</b> 1310 304 158</p> <p><b>EX / CROSS :</b></p> <p><b>Model:</b> 6S 1350 BO 6S 1600BD 6S 1601BD IT 6S 1700BO 6S 1701BO IT 6S 1900BO 6S 1901BO IT</p>	<p><b>Packaging Unit:</b> 1</p>
<p><b>T80347</b></p> 	<p><b>Description:</b> SYNCHRO HUB</p> <p><b>OEM No :</b> 1346 304 021</p> <p><b>EX / CROSS :</b></p> <p><b>Model:</b> 6AS 700TO 6AS 800TO 6AS 805TO 6S 800TO AS Tronic</p>	<p><b>Packaging Unit:</b> 1</p>
<p><b>T81272</b></p> 	<p><b>Description:</b> SYNCHRO HUB</p> <p><b>OEM No :</b> 1290 304 380</p> <p><b>EX / CROSS :</b> 1290 304 180 1290 304 411</p> <p><b>Model:</b> S5 680 S5 680 SSO S6 36 S6 36+GV36 S6 36/2</p>	<p><b>Packaging Unit:</b> 1</p>
<p><b>T50176</b></p> 	<p><b>Description:</b> SYNCHRO HUB</p> <p><b>OEM No :</b> 1304 304 515</p> <p><b>EX / CROSS :</b> 1304 304 011</p> <p><b>Model:</b> 16S 109 8S 109</p>	<p><b>Packaging Unit:</b> 1</p>







<p><b>T59041</b></p> 	<p><b>Description:</b> SYNCHRO HUB</p> <p><b>OEM No :</b> 1304 332 066</p> <p><b>EX / CROSS :</b></p> <p><b>Model:</b> 16S 109 6S 150C 8S 109 8S 140 8S 180 9S 109</p>	<p><b>Packaging Unit:</b> 1</p>
<p><b>T22281</b></p> 	<p><b>Description:</b> SYNCHRO HUB</p> <p><b>OEM No :</b> 1356 304 022</p> <p><b>EX / CROSS :</b></p>	<p><b>Packaging Unit:</b> 1</p> <p><b>Model:</b> 16S 150 16S 151 16S 1620TD 16S 1621TD IT 16S 1625TD 16S 1625TD IT 16S 1630TD 16S 1631TD IT 16S 1635TD 16S 1635TD IT 16S 181 16S 1820TO 16S 1820TO RVI 16S 1821TO IT 16S 1822TO 16S 1823TO 16S 1825TO 16S 1825TO IT 16S 1830TO 16S 1831TO IT 16S 1833TO 16S 1835TO 16S 1835TO IT 16S 1837TO IT 16S 1920TD</p>
<p><b>T59047</b></p> 	<p><b>Description:</b> SYNCHRO HUB</p> <p><b>OEM No :</b> 1304 304 651</p> <p><b>EX / CROSS :</b> 1304 304 575</p>	<p><b>Packaging Unit:</b> 1</p> <p><b>Model:</b> 8S 180 8S 2100 8S 2100BD 8S 2100BO 8S 2101BD IT 8S 2101BO IT</p>
<p><b>T56727</b></p> 	<p><b>Description:</b> SYNCHRO HUB</p> <p><b>OEM No :</b> 0091 304 204</p> <p><b>EX / CROSS :</b> 1268 304 554</p>	<p><b>Packaging Unit:</b> 1</p> <p><b>Model:</b> S6 1550</p>
<p><b>T08892</b></p> 	<p><b>Description:</b> SYNCHRO HUB</p> <p><b>OEM No :</b> 1297 304 031</p> <p><b>EX / CROSS :</b></p>	<p><b>Packaging Unit:</b> 1</p> <p><b>Model:</b></p>







<p><b>T56218</b></p> 	<p><b>Description:</b> SYNCHRO HUB</p> <p><b>OEM No :</b> 1304 304 051</p> <p><b>EX / CROSS :</b></p>	<p><b>Packaging Unit:</b> 1</p> <p><b>Model:</b> 6S 150C 8S 140 9S 109</p>
<p><b>T77108</b></p> 	<p><b>Description:</b> SYNCHRO HUB</p> <p><b>OEM No :</b> 1346 304 091</p> <p><b>EX / CROSS :</b></p>	<p><b>Packaging Unit:</b> 1</p> <p><b>Model:</b> 6S 100TO 6S 800TO</p>
<p><b>T08893</b></p> 	<p><b>Description:</b> SYNCHRO HUB</p> <p><b>OEM No :</b> 1272 304 130</p> <p><b>EX / CROSS :</b></p>	<p><b>Packaging Unit:</b> 1</p> <p><b>Model:</b></p>
<p><b>T10114</b></p> 	<p><b>Description:</b> SYNCHRO HUB</p> <p><b>OEM No :</b> 1269 304 018</p> <p><b>EX / CROSS :</b></p>	<p><b>Packaging Unit:</b> 1</p> <p><b>Model:</b></p>
<p><b>T55145</b></p> 	<p><b>Description:</b> SYNCHRO HUB</p> <p><b>OEM No :</b> 1297 333 115</p> <p><b>EX / CROSS :</b></p>	<p><b>Packaging Unit:</b> 1</p> <p><b>Model:</b> 16S 190 16S 190/1 16S 220 16S 220A 16S 221 16S 2520TO 16S 2520TO IT 8S 221 Ecosplit III</p>

<p><b>T69054</b></p> 	<p><b>Description:</b> SYNCHRO HUB</p> <p><b>OEM No :</b> 1304 304 687</p> <p><b>EX / CROSS :</b> 1304 304 645</p> <p><b>Model:</b> 16S 109 6S 700BO 6S 850 6S 890 8S 109 S6 36</p>	<p><b>Packaging Unit:</b> 1</p>
<p><b>T77284</b></p> 	<p><b>Description:</b> SYNCHRO HUB</p> <p><b>OEM No :</b> 1304 304 653</p> <p><b>EX / CROSS :</b> 1304 304 697</p> <p><b>Model:</b> 16S 109 6S 850 8S 109 S6 36 S6 36+GV36 S6 36/2</p>	<p><b>Packaging Unit:</b> 1</p>
<p><b>T55222</b></p> 	<p><b>Description:</b> SYNCHRO HUB</p> <p><b>OEM No :</b> 1290 304 379</p> <p><b>EX / CROSS :</b> 1290 304 343</p> <p><b>Model:</b> S5 680 S6 36 S6 36+GV36 S6 36/2</p>	<p><b>Packaging Unit:</b> 1</p>
<p><b>T15353</b></p> 	<p><b>Description:</b> SYNCHRO HUB</p> <p><b>OEM No :</b> (1307 204 244/HUB)</p> <p><b>EX / CROSS :</b> 1308 304 066 1307 304 607 1307 304 168</p> <p><b>Model:</b></p>	<p><b>Packaging Unit:</b> 1</p>
<p><b>T39075</b></p> 	<p><b>Description:</b> SYNCHRO HUB</p> <p><b>OEM No :</b> 1346 304 025</p> <p><b>EX / CROSS :</b></p> <p><b>Model:</b> 6AS 1000TO 6AS 1005TO 6AS 1010 BO 6AS 1110BO 6S 1000TO 6S 1000TO KMZ 6S 1005TO 6S 1010BO AS Tronic</p>	<p><b>Packaging Unit:</b> 1</p>





<p><b>T59054</b></p> 	<p><b>Description:</b> SYNCHRO HUB</p> <p><b>OEM No :</b> 1304 304 576</p> <p><b>EX / CROSS :</b></p> <p><b>Model:</b> 8S 180 8S 2100 8S 2100BD 8S 2100BO 8S 2101BD IT 8S 2101BO IT</p>	<p><b>Packaging Unit:</b> 1</p>
<p><b>T77141</b></p> 	<p><b>Description:</b> SYNCHRO HUB</p> <p><b>OEM No :</b> 1346 304 026</p> <p><b>EX / CROSS :</b> 0769 171 850 1346 304 173</p> <p><b>Model:</b> 6AS 1000TO 6AS 1005TO 6AS 1010 BO 6AS 1110BO 6AS 800TO 6AS 805TO 6S 1000TO 6S 1005TO 6S 1010BO AS Tronic</p>	<p><b>Packaging Unit:</b> 1</p>
<p><b>T08580</b></p> 	<p><b>Description:</b> SYNCHRO HUB (19-22T.)</p> <p><b>OEM No :</b> 1250 304 185</p> <p><b>EX / CROSS :</b> 1250 304 054</p> <p><b>Model:</b></p>	<p><b>Packaging Unit:</b> 1</p>
<p><b>T15393</b></p> 	<p><b>Description:</b> SYNCHRO HUB (22-34T.)</p> <p><b>OEM No :</b> 1246 304 136</p> <p><b>EX / CROSS :</b></p> <p><b>Model:</b></p>	<p><b>Packaging Unit:</b> 1</p>
<p><b>T08581</b></p> 	<p><b>Description:</b> SYNCHRO HUB (22-36T.)</p> <p><b>OEM No :</b> 1250 304 234</p> <p><b>EX / CROSS :</b></p> <p><b>Model:</b></p>	<p><b>Packaging Unit:</b> 1</p>

<p><b>T14271</b></p> 	<p><b>Description:</b> SYNCHRO HUB (22-38T.)</p> <p><b>OEM No :</b> 1292 304 026</p> <p><b>EX / CROSS :</b></p>	<p><b>Packaging Unit:</b> 1</p> <p><b>Model:</b></p>
<p><b>T20443</b></p> 	<p><b>Description:</b> SYNCHRO HUB (22T.)</p> <p><b>OEM No :</b> 1269 304 071</p> <p><b>EX / CROSS :</b></p>	<p><b>Packaging Unit:</b> 1</p> <p><b>Model:</b> 5K 110GP 5K 110GP+GV90 5K 110GPA 5S 110GP 5S 110GP+GV90 5S 110GPA 5S 110GPA+GV90</p>
<p><b>T20435</b></p> 	<p><b>Description:</b> SYNCHRO HUB (22T.)</p> <p><b>OEM No :</b> 1269 304 016</p> <p><b>EX / CROSS :</b></p>	<p><b>Packaging Unit:</b> 1</p> <p><b>Model:</b> 5K 110GPA 5K 110GPA+GV90</p>
<p><b>T22240</b></p> 	<p><b>Description:</b> SYNCHRO HUB (24-31T.)</p> <p><b>OEM No :</b> 1324 304 037</p> <p><b>EX / CROSS :</b> 1304 304 443</p>	<p><b>Packaging Unit:</b> 1</p> <p><b>Model:</b> 8S 140 9S 109 9S 1110TD 9S 1110TO 9S 1111TD IT 9S 1111TO IT 9S 1115TD 9S 1115TO 9S 1310TO 9S 1311TO IT 9S 1315TO</p>
<p><b>T08457</b></p> 	<p><b>Description:</b> SYNCHRO HUB (27-41T.)</p> <p><b>OEM No :</b> 1268 304 006</p> <p><b>EX / CROSS :</b></p>	<p><b>Packaging Unit:</b> 1</p> <p><b>Model:</b></p>







<p><b>T37967</b></p> 	<p><b>Description:</b> SYNCHRO HUB (48-22T.)</p> <p><b>OEM No :</b> 1311 304 226</p> <p><b>EX / CROSS :</b></p>	<p><b>Packaging Unit:</b> 1</p> <p><b>Model:</b> 6S 1000BD 6S 1000BO 6S 1200BD 6S 1200BO 6S 1200BO IKA 6S 1200BO KMZ 6S 1200TD 6S 1200TO 6S 1205TD S6 66 S6 66+GV66 S6 85 S6 85 LIAZ S6 85 MAN S6 85 MAZ S6 85 NEFAZ</p>
<p><b>T08492</b></p> 	<p><b>Description:</b> SYNCHRO HUB (48-30T.)</p> <p><b>OEM No :</b> 1250 312 323</p> <p><b>EX / CROSS :</b> 1250 312 086</p>	<p><b>Packaging Unit:</b> 1</p> <p><b>Model:</b></p>
<p><b>T37642</b></p> 	<p><b>Description:</b> SYNCHRO HUB (48-39T.)</p> <p><b>OEM No :</b> 1317 304 168</p> <p><b>EX / CROSS :</b> 1317 304 026</p>	<p><b>Packaging Unit:</b> 1</p> <p><b>Model:</b></p>
<p><b>T22699</b></p> 	<p><b>Description:</b> SYNCHRO HUB (48-39T.)</p> <p><b>OEM No :</b> 1346 304 118</p> <p><b>EX / CROSS :</b> 1290 304 586</p>	<p><b>Packaging Unit:</b> 1</p> <p><b>Model:</b> 6S 700BO KAVZ</p>
<p><b>T20715</b></p> 	<p><b>Description:</b> SYNCHRO HUB (48T.)</p> <p><b>OEM No :</b> 1324 304 006</p> <p><b>EX / CROSS :</b></p>	<p><b>Packaging Unit:</b> 1</p> <p><b>Model:</b> 9S 1110TD 9S 1110TO 9S 1111TD IT 9S 1111TO IT 9S 1115TD 9S 1115TO 9S 1310TO 9S 1310TO KMZ 9S 1311TO IT 9S 1315TO</p>



<p><b>T08483</b></p> 	<p><b>Description:</b> SYNCHRO HUB (51-22T.)</p> <p><b>OEM No :</b> 1272 304 078</p> <p><b>EX / CROSS :</b> 1246 304 135 1250 304 169 1250 304 229</p>	<p><b>Packaging Unit:</b> 1</p> <p><b>Model:</b></p>
<p><b>T08501</b></p> 	<p><b>Description:</b> SYNCHRO HUB (51-22T.)</p> <p><b>OEM No :</b> 1272 304 135</p> <p><b>EX / CROSS :</b></p>	<p><b>Packaging Unit:</b> 1</p> <p><b>Model:</b></p>
<p><b>T08877</b></p> 	<p><b>Description:</b> SYNCHRO HUB (51-24T.)</p> <p><b>OEM No :</b> 1269 304 128</p> <p><b>EX / CROSS :</b> 1269 304 011</p>	<p><b>Packaging Unit:</b> 1</p> <p><b>Model:</b></p>
<p><b>T09057</b></p> 	<p><b>Description:</b> SYNCHRO HUB (51-24T.)</p> <p><b>OEM No :</b> 1292 304 041</p> <p><b>EX / CROSS :</b></p>	<p><b>Packaging Unit:</b> 1</p> <p><b>Model:</b></p>
<p><b>T11765</b></p> 	<p><b>Description:</b> SYNCHRO HUB (51-34T.)</p> <p><b>OEM No :</b> 1272 304 075</p> <p><b>EX / CROSS :</b> 1246 304 134</p>	<p><b>Packaging Unit:</b> 1</p> <p><b>Model:</b></p>





<p><b>T08883</b></p> 	<p><b>Description:</b> SYNCHRO HUB (51-36T.)</p> <p><b>Packaging Unit:</b> 1</p> <p><b>OEM No :</b> 1250 304 396</p> <p><b>Model:</b></p> <p><b>EX / CROSS :</b> 1250 304 166</p>
<p><b>T11770</b></p> 	<p><b>Description:</b> SYNCHRO HUB (51-38T.)</p> <p><b>Packaging Unit:</b> 1</p> <p><b>OEM No :</b> 1269 304 129</p> <p><b>Model:</b></p> <p><b>EX / CROSS :</b> 1269 304 013</p>
<p><b>T08888</b></p> 	<p><b>Description:</b> SYNCHRO HUB (51-38T.)</p> <p><b>Packaging Unit:</b> 1</p> <p><b>OEM No :</b> 1292 304 052</p> <p><b>Model:</b></p> <p><b>EX / CROSS :</b> 1292 304 040</p>
<p><b>T14786</b></p> 	<p><b>Description:</b> SYNCHRO HUB (51-54T.)</p> <p><b>Packaging Unit:</b> 1</p> <p><b>OEM No :</b> 1272 333 020</p> <p><b>Model:</b></p> <p><b>EX / CROSS :</b> 1272 333 027 1285 333 003</p>
<p><b>T22704</b></p> 	<p><b>Description:</b> SYNCHRO HUB (54-62T.)</p> <p><b>Packaging Unit:</b> 1</p> <p><b>OEM No :</b> 1290 304 618</p> <p><b>Model:</b> 6S 700BO 6S 700BO KAVZ 6S 850 6S 890</p> <p><b>EX / CROSS :</b> 1317 304 031 1290 304 619 1317 304 169</p>

<p><b>T38449</b></p> 	<p><b>Description:</b> SYNCHRO HUB (57-31T.)</p> <p><b>OEM No :</b> 1310 304 080</p> <p><b>EX / CROSS :</b></p>	<p><b>Packaging Unit:</b> 1</p> <p><b>Model:</b> 6S 1000BD 6S 1000BO 6S 1200BD 6S 1200BO 6S 1200BO IKA 6S 1200BO KMZ 6S 1200TD 6S 1200TO 6S 1205TD S6 85 S6 85 LIAZ S6 85 MAN</p>
<p><b>T22280</b></p> 	<p><b>Description:</b> SYNCHRO HUB (57-38T.)</p> <p><b>OEM No :</b> 1356 304 019</p> <p><b>EX / CROSS :</b></p>	<p><b>Packaging Unit:</b> 1</p> <p><b>Model:</b> 16S 150 16S 151 16S 151PTO HIN 16S 1620TD 16S 1621TD IT 16S 1625TD 16S 162TD IT 16S 1630TD 16S 1631TD IT 16S 1635TD 16S 163TD IT 16S 181 16S 1820TO 16S 1820TO RVI 16S 1821TO IT 16S 1822TO 16S 1823TO 16S 1825TO 16S 182TO IT 16S 1830TO 16S 1831TO IT 16S 1833TO 16S 1835TO 16S 183TO IT</p>
<p><b>T17886</b></p> 	<p><b>Description:</b> SYNCHRO HUB (57-38T.)</p> <p><b>OEM No :</b> 1312 304 052</p> <p><b>EX / CROSS :</b> 0091 304 361</p>	<p><b>Packaging Unit:</b> 1</p> <p><b>Model:</b></p>
<p><b>T17868</b></p> 	<p><b>Description:</b> SYNCHRO HUB (57T.)</p> <p><b>OEM No :</b> 1316 304 162</p> <p><b>EX / CROSS :</b> 1316 304 147</p>	<p><b>Packaging Unit:</b> 1</p> <p><b>Model:</b> 16S 150 16S 151 16S 151 DAF 16S 151 HIN 16S 151 HYU 16S 151 IVE 16S 151 KMZ 16S 151 MAN 16S 151 RVI 16S 151 SNVI 16S 151IT DAF 16S 151PTO HIN 16S 1685 16S 181 16S 181 IVE 16S 181 MAN 16S 181IT DAF 16S 1820TO KMZ 16S 1920TD 16S 1921TD IT 16S 1922TD 16S 1923TD 16S 220 16S 220A</p>
<p><b>T22103</b></p> 	<p><b>Description:</b> SYNCHRO HUB (60-62T.)</p> <p><b>OEM No :</b> 1307 204 230</p> <p><b>EX / CROSS :</b></p>	<p><b>Packaging Unit:</b> 1</p> <p><b>Model:</b> 5S 580 5S 600BO S5 42 S5 42 KAVZ S5 42 KMZ S5 42 MAZ S5 42 SNVI</p>

<p><b>T09559</b></p> 	<p><b>Description:</b> SYNCHRO HUB (60-62T.)</p> <p><b>OEM No :</b> 1307 304 167</p> <p><b>EX / CROSS :</b></p>	<p><b>Packaging Unit:</b> 1</p> <p><b>Model:</b> S5 42 S5 420</p>
<p><b>T08895</b></p> 	<p><b>Description:</b> SYNCHRO HUB (63-38T.)</p> <p><b>OEM No :</b> 1297 304 195</p> <p><b>EX / CROSS :</b></p>	<p><b>Packaging Unit:</b> 1</p> <p><b>Model:</b></p>
<p><b>T37954</b></p> 	<p><b>Description:</b> SYNCHRO HUB (63-38T.)</p> <p><b>OEM No :</b> 1310 304 157</p> <p><b>EX / CROSS :</b></p>	<p><b>Packaging Unit:</b> 1</p> <p><b>Model:</b> 6S 1000BD 6S 1000BO 6S 1200BD 6S 1200BO 6S 1200BO IKA 6S 1200BO KMZ 6S 1200TD 6S 1200TO 6S 1205TD S6 85 S6 85 LIAZ S6 85 MAN</p>
<p><b>T38706</b></p> 	<p><b>Description:</b> SYNCHRO HUB (63-38T.)</p> <p><b>OEM No :</b> 1316 304 179</p> <p><b>EX / CROSS :</b> 1316 304 152</p>	<p><b>Packaging Unit:</b> 1</p> <p><b>Model:</b> 16S 1650 16S 1650 IVE</p>
<p><b>T08885</b></p> 	<p><b>Description:</b> SYNCHRO HUB (63-41T.)</p> <p><b>OEM No :</b> 1268 304 150</p> <p><b>EX / CROSS :</b> 1268 304 007</p>	<p><b>Packaging Unit:</b> 1</p> <p><b>Model:</b></p>

<p><b>T08900</b></p> 	<p><b>Description:</b> SYNCHRO HUB (63-64T.)</p> <p><b>OEM No :</b> 1269 333 057</p> <p><b>EX / CROSS :</b> 1269 333 017 1269 333 043</p>	<p><b>Packaging Unit:</b> 1</p> <p><b>Model:</b></p>																								
<p><b>T08899</b></p> 	<p><b>Description:</b> SYNCHRO HUB (63-64T.)</p> <p><b>OEM No :</b> 1296 333 002</p> <p><b>EX / CROSS :</b> 1296 333 015</p>	<p><b>Packaging Unit:</b> 1</p> <p><b>Model:</b></p>																								
<p><b>T18047</b></p> 	<p><b>Description:</b> SYNCHRO HUB (63T.)</p> <p><b>OEM No :</b> 1312 304 158</p> <p><b>EX / CROSS :</b> 1312 304 181</p>	<p><b>Packaging Unit:</b> 1</p> <p><b>Model:</b></p> <table border="0"> <tr> <td>16S 150</td> <td>16S 1631TD IT</td> </tr> <tr> <td>16S 151</td> <td>16S 163TD IT</td> </tr> <tr> <td>16S 151 DAF</td> <td>16S 181</td> </tr> <tr> <td>16S 151 HIN</td> <td>16S 181 RVI</td> </tr> <tr> <td>16S 151 KMZ</td> <td>16S 181IT DAF</td> </tr> <tr> <td>16S 151 MAN</td> <td>16S 1820TO</td> </tr> <tr> <td>16S 151 RVI</td> <td>16S 1820TO KMZ</td> </tr> <tr> <td>16S 151 SNVI</td> <td>16S 1820TO IT</td> </tr> <tr> <td>16S 151IT DAF</td> <td>16S 1823TO</td> </tr> <tr> <td>16S 151PTO HIN</td> <td>16S 182TO IT</td> </tr> <tr> <td>16S 1620TD</td> <td>16S 1833TO</td> </tr> <tr> <td>16S 1630TD</td> <td>16S 1923TD</td> </tr> </table>	16S 150	16S 1631TD IT	16S 151	16S 163TD IT	16S 151 DAF	16S 181	16S 151 HIN	16S 181 RVI	16S 151 KMZ	16S 181IT DAF	16S 151 MAN	16S 1820TO	16S 151 RVI	16S 1820TO KMZ	16S 151 SNVI	16S 1820TO IT	16S 151IT DAF	16S 1823TO	16S 151PTO HIN	16S 182TO IT	16S 1620TD	16S 1833TO	16S 1630TD	16S 1923TD
16S 150	16S 1631TD IT																									
16S 151	16S 163TD IT																									
16S 151 DAF	16S 181																									
16S 151 HIN	16S 181 RVI																									
16S 151 KMZ	16S 181IT DAF																									
16S 151 MAN	16S 1820TO																									
16S 151 RVI	16S 1820TO KMZ																									
16S 151 SNVI	16S 1820TO IT																									
16S 151IT DAF	16S 1823TO																									
16S 151PTO HIN	16S 182TO IT																									
16S 1620TD	16S 1833TO																									
16S 1630TD	16S 1923TD																									
<p><b>T18052</b></p> 	<p><b>Description:</b> SYNCHRO HUB (63T.)</p> <p><b>OEM No :</b> 1313 333 001</p> <p><b>EX / CROSS :</b></p>	<p><b>Packaging Unit:</b> 1</p> <p><b>Model:</b></p> <table border="0"> <tr> <td>12S 2130TD</td> <td>16S 150</td> </tr> <tr> <td>12S 2131TD IT</td> <td>16S 151</td> </tr> <tr> <td>12S 2133TD</td> <td>16S 151 DAF</td> </tr> <tr> <td>12S 2330TD</td> <td>16S 151 HIN</td> </tr> <tr> <td>12S 2331TD IT</td> <td>16S 151 HYU</td> </tr> <tr> <td>12S 2333TD</td> <td>16S 151 IVE</td> </tr> <tr> <td>12S 233TD IT</td> <td>16S 151 KMZ</td> </tr> <tr> <td>12S 2830TD</td> <td>16S 151 MAN</td> </tr> <tr> <td>12S 2831TD IT</td> <td>16S 151 RVI</td> </tr> <tr> <td>12S 2833TD</td> <td>16S 151 SNVI</td> </tr> <tr> <td>12S 283TD IT</td> <td>16S 151IT DAF</td> </tr> <tr> <td>16S 109</td> <td>16S 151PTO HIN</td> </tr> </table>	12S 2130TD	16S 150	12S 2131TD IT	16S 151	12S 2133TD	16S 151 DAF	12S 2330TD	16S 151 HIN	12S 2331TD IT	16S 151 HYU	12S 2333TD	16S 151 IVE	12S 233TD IT	16S 151 KMZ	12S 2830TD	16S 151 MAN	12S 2831TD IT	16S 151 RVI	12S 2833TD	16S 151 SNVI	12S 283TD IT	16S 151IT DAF	16S 109	16S 151PTO HIN
12S 2130TD	16S 150																									
12S 2131TD IT	16S 151																									
12S 2133TD	16S 151 DAF																									
12S 2330TD	16S 151 HIN																									
12S 2331TD IT	16S 151 HYU																									
12S 2333TD	16S 151 IVE																									
12S 233TD IT	16S 151 KMZ																									
12S 2830TD	16S 151 MAN																									
12S 2831TD IT	16S 151 RVI																									
12S 2833TD	16S 151 SNVI																									
12S 283TD IT	16S 151IT DAF																									
16S 109	16S 151PTO HIN																									
<p><b>T18287</b></p> 	<p><b>Description:</b> SYNCHRO HUB (63T.)</p> <p><b>OEM No :</b> 1313 304 008</p> <p><b>EX / CROSS :</b></p>	<p><b>Packaging Unit:</b> 1</p> <p><b>Model:</b></p> <table border="0"> <tr> <td>16S 150</td> <td>6S 1701BO IT</td> </tr> <tr> <td>16S 151</td> <td>6S 1701BO XAM</td> </tr> <tr> <td>16S 181</td> <td>6S 1900BO</td> </tr> <tr> <td>16S 182</td> <td>6S 1900BO HYU</td> </tr> <tr> <td>16S 220</td> <td>6S 1901BO IT</td> </tr> <tr> <td>16S 221</td> <td>Ecosplit III</td> </tr> <tr> <td>16S 251</td> <td></td> </tr> <tr> <td>6S 1600</td> <td></td> </tr> <tr> <td>6S 1600 KMZ</td> <td></td> </tr> <tr> <td>6S 1600BD</td> <td></td> </tr> <tr> <td>6S 1601BD IT</td> <td></td> </tr> <tr> <td>6S 1700BO</td> <td></td> </tr> </table>	16S 150	6S 1701BO IT	16S 151	6S 1701BO XAM	16S 181	6S 1900BO	16S 182	6S 1900BO HYU	16S 220	6S 1901BO IT	16S 221	Ecosplit III	16S 251		6S 1600		6S 1600 KMZ		6S 1600BD		6S 1601BD IT		6S 1700BO	
16S 150	6S 1701BO IT																									
16S 151	6S 1701BO XAM																									
16S 181	6S 1900BO																									
16S 182	6S 1900BO HYU																									
16S 220	6S 1901BO IT																									
16S 221	Ecosplit III																									
16S 251																										
6S 1600																										
6S 1600 KMZ																										
6S 1600BD																										
6S 1601BD IT																										
6S 1700BO																										



**T17869**

**Description:**  
SYNCHRO HUB (63T.)

**Packaging Unit:** 1

**OEM No :**  
1316 304 163

**Model:**

16S 150  
16S 151  
16S 151 HYU  
16S 151 IVE  
16S 1685  
16S 181  
16S 181 IVE  
16S 181 MAN  
16S 1920TD  
16S 1921TD IT  
16S 1922TD  
16S 220

16S 220A  
16S 221  
16S 221 MAN  
16S 221 VW  
16S 2280TO  
16S 251  
16S 251 NIS  
16S 2520TO MAN  
Ecosplit III

**EX / CROSS :**  
1316 304 148



**T81474**

**Description:**  
SYNCHRO KIT

**Packaging Unit:** 1

**OEM No :**  
1297 298 955

**Model:**

16S 150  
16S 151  
16S 181  
16S 182  
16S 220  
16S 220A  
16S 221  
16S 251  
Ecosplit III

**EX / CROSS :**



**T38173**

**Description:**  
SYNCHRO KIT

**Packaging Unit:** 1

**OEM No :**  
1290 204 091

**Model:**

6S 700BO  
6S 700BO KAVZ  
6S 890

**EX / CROSS :**  
1290 204 072



**T54548**

**Description:**  
SYNCHRO KIT

**Packaging Unit:** 1

**OEM No :**  
1328 298 002

**Model:**

12AS 1630TD  
12AS 1631TD IT  
12AS 1930TD  
12AS 1931TD IT  
12AS 1935TD  
12AS 2130TD  
12AS 2131TD IT  
12AS 2140TD  
12AS 2301  
12AS 2301IT  
12AS 2330TD  
12AS 2331TD IT

12AS 2335TD  
12AS 2340TD  
12AS 2341TD IT  
12AS 2540TD  
12AS 2541TD IT  
12AS 3000TD  
12AS 3000TD IT  
12AS 3001  
12AS 3001IT  
16AS 2230TD  
16AS 2231TD IT  
16AS 2600TO

**EX / CROSS :**  
1328 202 040  
1328 202 050

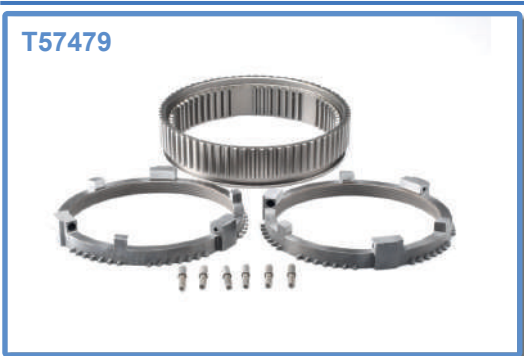

**T57479**

**Description:**  
SYNCHRO KIT

**Packaging Unit:** 1

**OEM No :**  
1328 233 001

**Model:**

10AS 2010B IT  
10AS 2300BO  
10AS 2310B  
10AS 2310B IT  
10AS 2700BO  
12 TX 1410 TD IT (1372 001 023)  
12 TX 1410 TD IT (1372 001 030)  
12 TX 1410 TO (1372 002 019)  
12 TX 1411 TD IT (1372 040 027)  
12 TX 1411 TD IT (1372 040 222)

12 TX 1415 TD IT (1372 001 026)  
12 TX 1610 TO IT (1372 002 025)  
12 TX 1610 TO IT (1372 002 045)  
12 TX 1611 BO IT (1372 044 006)  
12 TX 1611 BO IT (1372 044 033)  
12 TX 1611 BO IT (1372 044 050)  
12 TX 1611 BO IT (1372 044 254)

**EX / CROSS :**



**T18625**

**Description:**

SYNCHRO KIT 1ST-2ND SPEED

**Packaging Unit:** 1

**OEM No :**

1312 298 911

**Model:**

16S 150  
16S 151  
16S 1620TD  
16S 1630TD  
16S 1631TD IT  
16S 163TD IT  
16S 181  
16S 1820TO  
16S 1821TO IT  
16S 1823TO  
16S 182TO IT  
16S 1833TO

16S 1923TD  
16S 1930TD  
16S 1931TD IT  
16S 1933TD  
16S 193TD IT  
16S 220  
16S 220A  
16S 221  
16S 2220TO  
16S 2230TO  
16S 2231TO IT  
16S 2233TO

**EX / CROSS :**

1312 204 035

1312 204 037

1312 204 043

1315 204 006



**T51034**

**Description:**

SYNCHRO KIT 1ST-2ND SPEED

**Packaging Unit:** 1

**OEM No :**

1324 298 003

**Model:**

9S 1110TD  
9S 1110TO  
9S 1111TD IT  
9S 1111TO IT  
9S 1115TD  
9S 1115TO  
9S 1310TO  
9S 1311TO IT  
9S 1315TO

**EX / CROSS :**



**T74672**

**Description:**

SYNCHRO KIT 1ST-2ND SPEED

**Packaging Unit:** 1

**OEM No :**

1307 298 001

**Model:**

5S 600BO  
S5 42

**EX / CROSS :**

1307 204 266

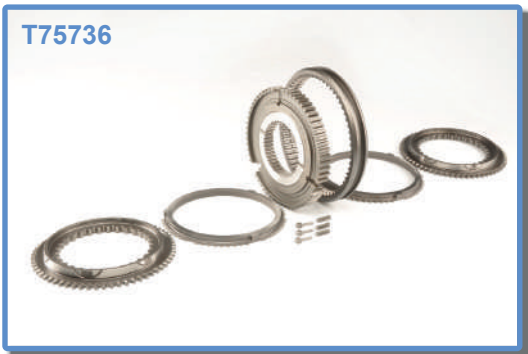

**T75736**

**Description:**

SYNCHRO KIT 1ST-2ND SPEED

**Packaging Unit:** 1

**OEM No :**

1316 204 017

**Model:**

16S 151 HYU  
16S 181 IVE  
16S 181 MAN  
16S 221 MAN  
16S 251 NIS  
16S 2520TO MAN

**EX / CROSS :**

1316 204 015

1316 204 012

1315 298 060

1315 298 054



**T76659**

**Description:**

SYNCHRO KIT 1ST-2ND SPEED

**Packaging Unit:** 1

**OEM No :**

1307 204 243

**Model:**

S5 42

**EX / CROSS :**

1307 204 128

1307 204 093

1307 204 084

<p><b>T78329</b></p> 	<p><b>Description:</b> SYNCHRO KIT 1ST-2ND SPEED</p> <p><b>OEM No :</b> 1346 298 003</p> <p><b>EX / CROSS :</b> 1346 204 002</p> <p><b>Model:</b> 6AS 1000TO 6AS 1005TO 6AS 1010 BO 6AS 1110BO 6AS 800TO 6AS 805TO 6S 1000TO 6S 1005TO 6S 1010BO AS Tronic</p>	<p><b>Packaging Unit:</b> 1</p>
<p><b>T78431</b></p> 	<p><b>Description:</b> SYNCHRO KIT 1ST-2ND SPEED</p> <p><b>OEM No :</b> 1328 298 001</p> <p><b>EX / CROSS :</b> 1328 202 049 1328 202 039 1328 202 016</p> <p><b>Model:</b> 10AS 2010B IT 10AS 2300BO 10AS 2310B 10AS 2310B IT 10AS 2700BO 12AS 1601BO IT 12AS 1930TO 12AS 1931TO IT 12AS 2000B IT 12AS 2000BO 12AS 2001BO IT 12AS 2130TO 12AS 2131TO IT 12AS 2300B IT 12AS 2300BO 12AS 2301 12AS 2301B IT 12AS 2301BO IT 12AS 2301IT 12AS 2330TO 12AS 2331TO IT 12AS 2335TO 12AS 2530TO 12AS 2531TO IT 12AS 2540TO</p>	<p><b>Packaging Unit:</b> 1</p>
<p><b>T84569</b></p> 	<p><b>Description:</b> SYNCHRO KIT 1ST-2ND SPEED</p> <p><b>OEM No :</b> 1304 204 059</p> <p><b>EX / CROSS :</b> 1290 204 075 1290 204 079</p> <p><b>Model:</b> 16S 109 6S 700BO 6S 890 8S 109 S6 36</p>	<p><b>Packaging Unit:</b> 1</p>
<p><b>T73315</b></p> 	<p><b>Description:</b> SYNCHRO KIT 1ST-2ND SPEED (SPECIAL ST VERSION)</p> <p><b>OEM No :</b> TAS73315</p> <p><b>EX / CROSS :</b></p> <p><b>Model:</b></p>	<p><b>Packaging Unit:</b> 1</p>
<p><b>T18637</b></p> 	<p><b>Description:</b> SYNCHRO KIT 3RD-4TH SPEED</p> <p><b>OEM No :</b> 1317 204 056</p> <p><b>EX / CROSS :</b></p> <p><b>Model:</b> S5 47</p>	<p><b>Packaging Unit:</b> 1</p>



**T39078**

**Description:**  
SYNCHRO KIT 3RD-4TH SPEED

**Packaging Unit:** 1

**OEM No :** 1346 298 004  
**Model:** 6S 1000TO KMZ

**EX / CROSS :**  
1346 204 005



**T51033**

**Description:**  
SYNCHRO KIT 3RD-4TH SPEED

**Packaging Unit:** 1

**OEM No :** 1324 298 004  
**Model:** 9S 1110TD  
9S 1110TO  
9S 1111TD IT  
9S 1111TO IT  
9S 1115TD  
9S 1115TO  
9S 1310TO  
9S 1311TO IT  
9S 1315TO

**EX / CROSS :**



**T76666**

**Description:**  
SYNCHRO KIT 3RD-4TH SPEED

**Packaging Unit:** 1

**OEM No :** 1307 204 317  
**Model:** 5S 580  
5S 600BO  
S5 42  
S5 42 KAVZ  
S5 42 KMZ  
S5 42 MAZ  
S5 42 SNVI

**EX / CROSS :**



**T80504**

**Description:**  
SYNCHRO KIT 3RD-4TH SPEED

**Packaging Unit:** 1

**OEM No :** 1316 204 011  
**Model:** 16S 150  
16S 151  
16S 181  
16S 1920TD  
16S 1921TD IT  
16S 1922TD  
16S 1923TD  
16S 220  
16S 220A  
16S 221  
16S 251  
Ecosplit III

**EX / CROSS :**

1315 298 055

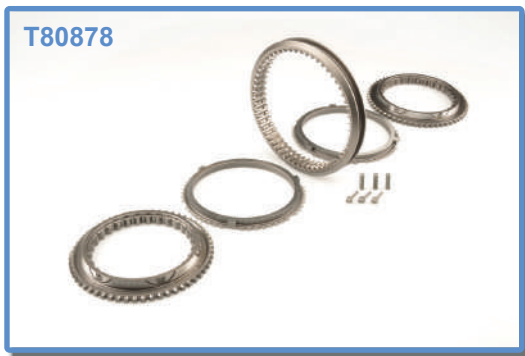

**T80878**

**Description:**  
SYNCHRO KIT 3RD-4TH SPEED (MOLYBDENUM)

**Packaging Unit:** 1





**OEM No :** 1325 298 008  
**Model:** 16S 150  
16S 151  
16S 1822TO  
16S 1823TO  
16S 1825TO  
16S 182TO IT  
16S 1833TO  
16S 1920TD  
16S 1921TD IT  
16S 1922TD  
16S 1923TD  
16S 1930TD  
16S 1931TD IT  
16S 1933TD

**EX / CROSS :**

1316 298 037 MO

1315 298 008



<p><b>T70109</b></p> 	<p><b>Description:</b> SYNCHRO KIT 3RD-4TH SPEED (MOLYBDENUM)</p> <p><b>Packaging Unit:</b> 1</p> <p><b>OEM No :</b> 1356 204 006</p> <p><b>EX / CROSS :</b></p> <p><b>Model:</b></p> <table border="0"> <tr><td>16S 150</td><td>16S 1821TO IT</td></tr> <tr><td>16S 151</td><td>16S 1822TO</td></tr> <tr><td>16S 151PTO HIN</td><td>16S 1823TO</td></tr> <tr><td>16S 1620TD</td><td>16S 1825TO</td></tr> <tr><td>16S 1621TD IT</td><td>16S 1827TO IT</td></tr> <tr><td>16S 1625TD</td><td>16S 1833TO</td></tr> <tr><td>16S 1627TD IT</td><td>16S 1920TD</td></tr> <tr><td>16S 1630TD</td><td>16S 1921TD IT</td></tr> <tr><td>16S 1631TD IT</td><td>16S 1922TD</td></tr> <tr><td>16S 1637TD IT</td><td>16S 1923TD</td></tr> <tr><td>16S 181</td><td>16S 1930TD</td></tr> <tr><td>16S 1820TO</td><td>16S 1931TD IT</td></tr> </table>	16S 150	16S 1821TO IT	16S 151	16S 1822TO	16S 151PTO HIN	16S 1823TO	16S 1620TD	16S 1825TO	16S 1621TD IT	16S 1827TO IT	16S 1625TD	16S 1833TO	16S 1627TD IT	16S 1920TD	16S 1630TD	16S 1921TD IT	16S 1631TD IT	16S 1922TD	16S 1637TD IT	16S 1923TD	16S 181	16S 1930TD	16S 1820TO	16S 1931TD IT
16S 150	16S 1821TO IT																								
16S 151	16S 1822TO																								
16S 151PTO HIN	16S 1823TO																								
16S 1620TD	16S 1825TO																								
16S 1621TD IT	16S 1827TO IT																								
16S 1625TD	16S 1833TO																								
16S 1627TD IT	16S 1920TD																								
16S 1630TD	16S 1921TD IT																								
16S 1631TD IT	16S 1922TD																								
16S 1637TD IT	16S 1923TD																								
16S 181	16S 1930TD																								
16S 1820TO	16S 1931TD IT																								
<p><b>T41972</b></p> 	<p><b>Description:</b> SYNCHRO KIT 3RD-4TH SPEED W/CONE FOR 16S2220TD</p> <p><b>Packaging Unit:</b> 1</p> <p><b>OEM No :</b> TAS41972</p> <p><b>EX / CROSS :</b></p> <p><b>Model:</b></p>																								
<p><b>T43994</b></p> 	<p><b>Description:</b> SYNCHRO KIT 5TH SPEED &amp; REVERSE</p> <p><b>Packaging Unit:</b> 1</p> <p><b>OEM No :</b> 1307 204 293</p> <p><b>EX / CROSS :</b></p> <p><b>Model:</b></p> <table border="0"> <tr><td>5S 580</td></tr> <tr><td>5S 600BO</td></tr> <tr><td>S5 42</td></tr> <tr><td>S5 42 KAVZ</td></tr> <tr><td>S5 42 KMZ</td></tr> <tr><td>S5 42 MAZ</td></tr> <tr><td>S5 42 SNVI</td></tr> </table>	5S 580	5S 600BO	S5 42	S5 42 KAVZ	S5 42 KMZ	S5 42 MAZ	S5 42 SNVI																	
5S 580																									
5S 600BO																									
S5 42																									
S5 42 KAVZ																									
S5 42 KMZ																									
S5 42 MAZ																									
S5 42 SNVI																									
<p><b>T46557</b></p> 	<p><b>Description:</b> SYNCHRO KIT 5TH-6TH SPEED</p> <p><b>Packaging Unit:</b> 1</p> <p><b>OEM No :</b> 1346 204 004</p> <p><b>EX / CROSS :</b></p> <p><b>Model:</b></p> <table border="0"> <tr><td>6AS 1000TO</td></tr> <tr><td>6AS 1005TO</td></tr> <tr><td>6AS 1110BO</td></tr> <tr><td>6AS 700TO</td></tr> <tr><td>6AS 800TO</td></tr> <tr><td>6AS 805TO</td></tr> <tr><td>6S 1000TO</td></tr> <tr><td>6S 1005TO</td></tr> <tr><td>6S 1010BO</td></tr> <tr><td>6S 800TO</td></tr> <tr><td>AS Tronic</td></tr> </table>	6AS 1000TO	6AS 1005TO	6AS 1110BO	6AS 700TO	6AS 800TO	6AS 805TO	6S 1000TO	6S 1005TO	6S 1010BO	6S 800TO	AS Tronic													
6AS 1000TO																									
6AS 1005TO																									
6AS 1110BO																									
6AS 700TO																									
6AS 800TO																									
6AS 805TO																									
6S 1000TO																									
6S 1005TO																									
6S 1010BO																									
6S 800TO																									
AS Tronic																									
<p><b>T78301</b></p> 	<p><b>Description:</b> SYNCHRO KIT 5TH-6TH SPEED</p> <p><b>Packaging Unit:</b> 1</p> <p><b>OEM No :</b> 1346 298 005</p> <p><b>EX / CROSS :</b></p> <p><b>Model:</b></p> <table border="0"> <tr><td>6AS 1000TO</td></tr> <tr><td>6AS 1005TO</td></tr> <tr><td>6AS 1010 BO</td></tr> <tr><td>6AS 1110BO</td></tr> <tr><td>6S 1000TO</td></tr> <tr><td>6S 1005TO</td></tr> <tr><td>6S 1010BO</td></tr> <tr><td>AS Tronic</td></tr> </table>	6AS 1000TO	6AS 1005TO	6AS 1010 BO	6AS 1110BO	6S 1000TO	6S 1005TO	6S 1010BO	AS Tronic																
6AS 1000TO																									
6AS 1005TO																									
6AS 1010 BO																									
6AS 1110BO																									
6S 1000TO																									
6S 1005TO																									
6S 1010BO																									
AS Tronic																									



**T45296**

**Description:**

SYNCHRO KIT FOR ECOMID 9S1310

**Packaging Unit:** 1

**OEM No :**  
TAS45296

**Model:**  
9S 1310TO KMZ

**EX / CROSS :**  
(9S1110/SYNCHRO)



**T37740**

**Description:**

SYNCHRO PLATE

**Packaging Unit:** 1

**OEM No :**  
1328 302 132

**Model:**

10AS 2010B IT	12AS 1931TD IT
10AS 2300BO	12AS 1931TO IT
10AS 2310B	12AS 1935TD
10AS 2310B IT	12AS 2000B IT
10AS 2700BO	12AS 2000BO
12AS 1601BO IT	12AS 2001BO IT
12AS 1630TD	12AS 2130TD
12AS 1631TD IT	12AS 2130TO
12AS 1800	12AS 2131TD IT
12AS 1800IT	12AS 2131TO IT
12AS 1930TD	12AS 2140TD
12AS 1930TO	12AS 2300B IT

**EX / CROSS :**  
1328 302 015  
1328 302 109



**T76007**

**Description:**

SYNCHRO PLATE

**Packaging Unit:** 1

**OEM No :**  
1358 302 262

**Model:**

12 TX 1410 TD IT (1372 001 023)	12 TX 1611 BO IT (1372 044 050)
12 TX 1410 TD IT (1372 001 030)	12 TX 1611 BO IT (1372 044 051)
12 TX 1410 TO (1372 002 019)	12 TX 1611 BO IT (1372 044 071)
12 TX 1411 TD IT (1372 040 027)	12 TX 1611 BO IT (1372 044 075)
12 TX 1411 TD IT (1372 040 028)	12 TX 1611 TO IT (1372 041 015)
12 TX 1411 TD IT (1372 040 029)	12 TX 1611 TO IT (1372 041 016)
12 TX 1411 TO IT (1372 041 017)	12 TX 1810 TD IT (1372 001 024)

**EX / CROSS :**

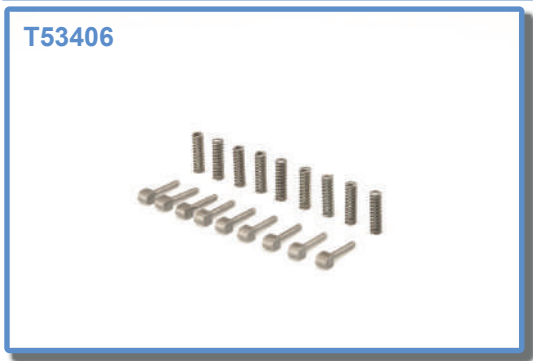

**T53406**

**Description:**

SYNCHRO REPAIR KIT

**Packaging Unit:** 1

**OEM No :**  
1311 198 401

**Model:**

S6 1550

**EX / CROSS :**



**T73169**

**Description:**

SYNCHRO REPAIR KIT





**Packaging Unit:** 1

**OEM No :**  
1290 198 406

**Model:**



S5 680 SSO

**EX / CROSS :**

<p><b>T18614</b></p> 	<p><b>Description:</b> SYNCHRO REPAIR KIT</p> <p><b>OEM No :</b> 1290 204 073</p> <p><b>EX / CROSS :</b></p>	<p><b>Packaging Unit:</b> 1</p> <p><b>Model:</b> 6S 850 DAF 6S 850 MAN</p>
<p><b>T17871</b></p> 	<p><b>Description:</b> SYNCHRO RING</p> <p><b>OEM No :</b> 1316 304 168</p> <p><b>EX / CROSS :</b> 1297 304 507 1316 304 149</p>	<p><b>Packaging Unit:</b> 1</p> <p><b>Model:</b> 16S 150 16S 151 16S 151 IVE 16S 151 MAN 16S 151PTO HIN 16S 1650 IVE 16S 1685 16S 181 16S 1820TO KMZ 16S 1920TD 16S 1921TD IT 16S 1922TD 16S 1923TD 16S 220 16S 220A 16S 221 16S 221 VW 16S 2280TO 16S 251 Ecosplit III</p>
<p><b>T38872</b></p> 	<p><b>Description:</b> SYNCHRO RING</p> <p><b>OEM No :</b> 1346 304 038</p> <p><b>EX / CROSS :</b></p>	<p><b>Packaging Unit:</b> 1</p> <p><b>Model:</b> 6S 1000TO 6S 800TO</p>
<p><b>T19824</b></p> 	<p><b>Description:</b> SYNCHRO RING</p> <p><b>OEM No :</b> 1304 333 005</p> <p><b>EX / CROSS :</b></p>	<p><b>Packaging Unit:</b> 1</p> <p><b>Model:</b> 16S 109 16S 109 STR 6S 150C 8S 109 8S 140 8S 180 8S 180 ENASA 9S 109 9S 109 MAN 9S 109 SNVI</p>
<p><b>T77396</b></p> 	<p><b>Description:</b> SYNCHRO RING</p> <p><b>OEM No :</b> 1336 333 004</p> <p><b>EX / CROSS :</b></p>	<p><b>Packaging Unit:</b> 1</p> <p><b>Model:</b> 12AS 1210TO 12AS 1220TD 12AS 1420TD 12AS 1420TO 12AS 1620TO AS Tronic</p>







<p><b>T22149</b></p> 	<p><b>Description:</b> SYNCHRO RING</p> <p><b>OEM No :</b> 1307 304 644</p> <p><b>EX / CROSS :</b> 1306 304 085 1307 304 589</p>	<p><b>Packaging Unit:</b> 1</p> <p><b>Model:</b> 5S 580 5S 600BO S5 42 S5 42 KAVZ S5 42 KMZ S5 42 MAZ S5 42 SNVI</p>
<p><b>T08856</b></p> 	<p><b>Description:</b> SYNCHRO RING</p> <p><b>OEM No :</b> 1272 333 019</p> <p><b>EX / CROSS :</b> 1272 333 014</p>	<p><b>Packaging Unit:</b> 1</p> <p><b>Model:</b></p>
<p><b>T39060</b></p> 	<p><b>Description:</b> SYNCHRO RING</p> <p><b>OEM No :</b> 1290 304 366</p> <p><b>EX / CROSS :</b> 6002 306 154</p>	<p><b>Packaging Unit:</b> 1</p> <p><b>Model:</b> 16S 109 6S 700BO 6S 850 6S 850 DAF 6S 850 MAN 6S 890 8S 109 9S 109 S5 680 S6 36 S6 680</p>
<p><b>T77105</b></p> 	<p><b>Description:</b> SYNCHRO RING</p> <p><b>OEM No :</b> 1346 304 033</p> <p><b>EX / CROSS :</b></p>	<p><b>Packaging Unit:</b> 1</p> <p><b>Model:</b> 6S 100TO 6S 800TO</p>
<p><b>T39059</b></p> 	<p><b>Description:</b> SYNCHRO RING</p> <p><b>OEM No :</b> 1290 304 350</p> <p><b>EX / CROSS :</b></p>	<p><b>Packaging Unit:</b> 1</p> <p><b>Model:</b> 16S 109 6S 700BO 6S 850 6S 850 DAF 6S 850 MAN 6S 890 8S 109 9S 109 S5 680 S6 36 S6 680</p>

<p><b>T15059</b></p> 	<p><b>Description:</b> SYNCHRO RING</p> <p><b>OEM No :</b> 1268 304 424</p> <p><b>EX / CROSS :</b></p>	<p><b>Packaging Unit:</b> 1</p> <p><b>Model:</b></p>
<p><b>T54547</b></p> 	<p><b>Description:</b> SYNCHRO RING</p> <p><b>OEM No :</b> 1328 202 047</p> <p><b>EX / CROSS :</b> 1328 202 043</p>	<p><b>Packaging Unit:</b> 1</p> <p><b>Model:</b> 12AS 1630TD 12AS 1631TD IT 12AS 1800 12AS 1800IT 12AS 1930TD 12AS 1931TD IT 12AS 1935TD 12AS 2130TD 12AS 2131TD IT 12AS 2140TD 12AS 2301 12AS 2301IT 12AS 2330TD 12AS 2331TD IT 12AS 2335TD 12AS 2340TD 12AS 2341TD IT 12AS 2540TD 12AS 2541TD IT 12AS 3000TD 12AS 3000TD IT 12AS 3001 12AS 3001IT 16AS 2200TD</p>
<p><b>T77102</b></p> 	<p><b>Description:</b> SYNCHRO RING</p> <p><b>OEM No :</b> 1346 304 039</p> <p><b>EX / CROSS :</b> 1346 304 032</p>	<p><b>Packaging Unit:</b> 1</p> <p><b>Model:</b> 6S 1000TO 6S 800TO</p>
<p><b>T39058</b></p> 	<p><b>Description:</b> SYNCHRO RING</p> <p><b>OEM No :</b> 1290 304 438</p> <p><b>EX / CROSS :</b> 1290 304 356</p>	<p><b>Packaging Unit:</b> 1</p> <p><b>Model:</b> 16S 109 6S 700BO 6S 850 6S 850 DAF 6S 850 MAN 6S 890 8S 109 9S 109 S5 680 S6 36 S6 680</p>
<p><b>T54546</b></p> 	<p><b>Description:</b> SYNCHRO RING</p> <p><b>OEM No :</b> 1328 202 046</p> <p><b>EX / CROSS :</b> 1328 202 042 1328 302 011 1328 302 084 1328 302 111</p>	<p><b>Packaging Unit:</b> 1</p> <p><b>Model:</b> 10AS 2010B IT 10AS 2300BO 10AS 2310B 10AS 2310B IT 10AS 2700BO 12AS 1601BO IT 12AS 1630TD 12AS 1631TD IT 12AS 1800 12AS 1800IT 12AS 1930TD 12AS 1930TO 12AS 1931TD IT 12AS 1931TO IT 12AS 1935TD 12AS 2000B IT 12AS 2000BO 12AS 2001BO IT 12AS 2130TD 12AS 2130TO 12AS 2131TD IT 12AS 2131TO IT 12AS 2140TD 12AS 2300B IT</p>

<p><b>T15346</b></p> 	<p><b>Description:</b> SYNCHRO RING</p> <p><b>Packaging Unit:</b> 1</p> <p><b>OEM No :</b> 1268 304 594</p> <p><b>Model:</b></p> <p><b>EX / CROSS :</b> 1268 304 445</p>
<p><b>T54540</b></p> 	<p><b>Description:</b> SYNCHRO RING</p> <p><b>Packaging Unit:</b> 1</p> <p><b>OEM No :</b> 1328 333 005</p> <p><b>Model:</b> 10AS 2010B IT 10AS 2300BO 10AS 2310B 10AS 2310B IT 10AS 2700BO 12 TX 1410 TD IT (1372 001 023) 12 TX 1410 TD IT (1372 001 030) 12 TX 1410 TO (1372 002 019) 12 TX 1411 TD IT (1372 040 027) 12 TX 1411 TD IT (1372 040 027)</p> <p>12 TX 1415 TD IT (1372 001 026) 12 TX 1610 TO IT (1372 002 025) 12 TX 1610 TO IT (1372 002 045) 12 TX 1611 BO IT (1372 044 006) 12 TX 1611 BO IT (1372 044 033) 12 TX 1611 BO IT (1372 044 050) 12 TX 1611 BO IT (1372 044 051)</p> <p><b>EX / CROSS :</b> 1328 333 001</p>
<p><b>T76058</b></p> 	<p><b>Description:</b> SYNCHRO RING</p> <p><b>Packaging Unit:</b> 1</p> <p><b>OEM No :</b> 1358 202 020</p> <p><b>Model:</b> 12 TX 1410 TD IT (1372 001 023) 12 TX 1410 TD IT (1372 001 030) 12 TX 1410 TO (1372 002 019) 12 TX 1411 TD IT (1372 040 027) 12 TX 1411 TD IT (1372 040 028) 12 TX 1411 TD IT (1372 040 029) 12 TX 1411 TO IT (1372 041 017)</p> <p>12 TX 1611 BO IT (1372 044 050) 12 TX 1611 BO IT (1372 044 051) 12 TX 1611 BO IT (1372 044 071) 12 TX 1611 BO IT (1372 044 075) 12 TX 1611 TO IT (1372 041 015) 12 TX 1611 TO IT (1372 041 016) 12 TX 1810 TD IT (1372 001 024)</p> <p><b>EX / CROSS :</b></p>
<p><b>T38285</b></p> 	<p><b>Description:</b> SYNCHRO RING (30T.)</p> <p><b>Packaging Unit:</b> 1</p> <p><b>OEM No :</b> 1304 304 680</p> <p><b>Model:</b> 16S 109 16S 109 STR</p> <p><b>EX / CROSS :</b> 1304 304 496 1304 304 132</p>
<p><b>T38313</b></p> 	<p><b>Description:</b> SYNCHRO RING (45T.)</p> <p><b>Packaging Unit:</b> 1</p> <p><b>OEM No :</b> 1304 304 683</p> <p><b>Model:</b> 16S 109 16S 109 STR 6S 150C 8S 109 8S 140 9S 109 9S 109 MAN 9S 109 SNVI</p> <p><b>EX / CROSS :</b></p>



<p><b>T37714</b></p> 	<p><b>Description:</b> SYNCHRO RING (45T.)</p> <p><b>OEM No :</b> 6002 305 661</p> <p><b>EX / CROSS :</b> 6002 304 493 1290 304 473 1238 304 420 1238 304 389</p>	<p><b>Packaging Unit:</b> 1</p> <p><b>Model:</b> 6S 150C S5 35/2 S5 680 S5 680 SSO S6 36 S6 36+GV36 S6 36/2 S6 680</p>
<p><b>T11838</b></p> 	<p><b>Description:</b> SYNCHRO RING (48T.)</p> <p><b>OEM No :</b> 1317 304 150</p> <p><b>EX / CROSS :</b></p>	<p><b>Packaging Unit:</b> 1</p> <p><b>Model:</b> 5S 400V 6AS 1000TO 6AS 1005TO 6AS 1010 BO 6AS 1110BO 6AS 700TO 6AS 800TO 6AS 805TO 6S 1000TO 6S 1000TO KMZ 6S 1005TO 6S 1010BO 6S 700BO 6S 700BO KAVZ 6S 800TO 6S 850 6S 850 DAF 6S 850 MAN 6S 890 AS Tronic S5 47 S6 650</p>
<p><b>T19748</b></p> 	<p><b>Description:</b> SYNCHRO RING (48T.)</p> <p><b>OEM No :</b> 1311 304 255</p> <p><b>EX / CROSS :</b> 1311 304 010 1311 304 076</p>	<p><b>Packaging Unit:</b> 1</p> <p><b>Model:</b> 12AS 1210TO 12AS 1220TD 12AS 1420TD 12AS 1420TO 12AS 1620TO 6AS 700TO 6AS 800TO 6AS 805TO 6S 1000BD 6S 1000BO 6S 1200BD 6S 1200BO 6S 1200BO IKA 6S 1200BO KMZ 6S 1200TD 6S 1200TO 6S 1205TD 6S 800TO 8S 180 8S 180 ENASA 8S 2100 8S 2100BD 8S 2100BO 8S 2101BD IT</p>
<p><b>T08868</b></p> 	<p><b>Description:</b> SYNCHRO RING (48T.)</p> <p><b>OEM No :</b> 1250 304 417</p> <p><b>EX / CROSS :</b> 1240 304 206 1240 304 265 1240 304 291 1240 304 305</p>	<p><b>Packaging Unit:</b> 1</p> <p><b>Model:</b></p>
<p><b>T15575</b></p> 	<p><b>Description:</b> SYNCHRO RING (51T.)</p> <p><b>OEM No :</b> 1272 304 166</p> <p><b>EX / CROSS :</b> 1272 304 076* 1272 304 076</p>	<p><b>Packaging Unit:</b> 1</p> <p><b>Model:</b></p>

<p><b>T08947</b></p> 	<p><b>Description:</b> SYNCHRO RING (51T.)</p> <p><b>OEM No :</b> 1250 304 226</p> <p><b>EX / CROSS :</b> 1250 304 170 1250 304 203 1250 304 215 1250 304 315</p>	<p><b>Packaging Unit:</b> 1</p> <p><b>Model:</b></p>
<p><b>T38929</b></p> 	<p><b>Description:</b> SYNCHRO RING (51T.)</p> <p><b>OEM No :</b> 1290 304 474</p> <p><b>EX / CROSS :</b> 1290 304 098 1290 304 472 1290 395 311 1290 395 332</p>	<p><b>Packaging Unit:</b> 1</p> <p><b>Model:</b> S6 36 S6 36+GV36 S6 36/2</p>
<p><b>T22196</b></p> 	<p><b>Description:</b> SYNCHRO RING (54T.)</p> <p><b>OEM No :</b> 1317 304 149</p> <p><b>EX / CROSS :</b> 1317 304 114</p>	<p><b>Packaging Unit:</b> 1</p> <p><b>Model:</b> 6AS 700TO 6S 700BO 6S 700BO KAVZ 6S 850 6S 850 DAF 6S 850 MAN 6S 890 AS Tronic S5 47 S6 650</p>
<p><b>T15078</b></p> 	<p><b>Description:</b> SYNCHRO RING (57T.)</p> <p><b>OEM No :</b> 1297 304 484</p> <p><b>EX / CROSS :</b> 1297 304 402 1297 304 433 1297 304 505</p>	<p><b>Packaging Unit:</b> 1</p> <p><b>Model:</b></p>
<p><b>T15151</b></p> 	<p><b>Description:</b> SYNCHRO RING (57T.)</p> <p><b>OEM No :</b> 1304 304 686</p> <p><b>EX / CROSS :</b> 1304 304 134 1304 304 134* 1295 304 004 2074 315 037</p>	<p><b>Packaging Unit:</b> 1</p> <p><b>Model:</b></p>





<p><b>T22275</b></p> 	<p><b>Description:</b> SYNCHRO RING (57T.) (MOLYBDENUM)</p> <p><b>OEM No :</b> 1316 304 189</p> <p><b>EX / CROSS :</b> 1316 304 196/M</p>	<p><b>Packaging Unit:</b> 1</p> <p><b>Model:</b> 12S 2130TD 12S 2131TD IT 12S 2133TD 12S 2330TD 12S 2331TD IT 12S 2333TD 12S 2337TD IT 12S 2830TD 12S 2831TD IT 12S 2833TD 12S 2837TD IT 16S 150</p> <p>16S 151 16S 151PTO HIN 16S 1620TD 16S 1621TD IT 16S 1625TD 16S 1627TD IT 16S 1630TD 16S 1631TD IT 16S 1635TD 16S 1637TD IT 16S 181 16S 1820TO</p>
<p><b>T67102</b></p> 	<p><b>Description:</b> SYNCHRO RING (60T.)</p> <p><b>OEM No :</b> OE1307 304 175</p> <p><b>EX / CROSS :</b></p>	<p><b>Packaging Unit:</b> 1</p> <p><b>Model:</b></p>
<p><b>T09561</b></p> 	<p><b>Description:</b> SYNCHRO RING (60T.)</p> <p><b>OEM No :</b> 1307 304 175</p> <p><b>EX / CROSS :</b></p>	<p><b>Packaging Unit:</b> 1</p> <p><b>Model:</b> S5 42 S5 420</p>
<p><b>T22131</b></p> 	<p><b>Description:</b> SYNCHRO RING (60T.)</p> <p><b>OEM No :</b> 1307 304 643</p> <p><b>EX / CROSS :</b> 1308 304 097 1307 304 588 1308 304 095 1307 304 262</p>	<p><b>Packaging Unit:</b> 1</p> <p><b>Model:</b> 5S 580 5S 600BO S5 42 S5 42 KAVZ S5 42 KMZ S5 42 MAZ S5 42 SNVI</p>
<p><b>T09563</b></p> 	<p><b>Description:</b> SYNCHRO RING (60T.)</p> <p><b>OEM No :</b> 1307 304 182</p> <p><b>EX / CROSS :</b> 1307 304 268</p>	<p><b>Packaging Unit:</b> 1</p> <p><b>Model:</b> 5S 580 5S 600BO S5 42 S5 42 KAVZ S5 42 KMZ S5 42 MAZ S5 42 SNVI S5 420</p>







<p><b>T15084</b></p> 	<p><b>Description:</b> SYNCHRO RING (63T.)</p> <p><b>OEM No :</b> 1296 333 045</p> <p><b>EX / CROSS :</b> 1296 333 044 1296 333 033 1296 333 022 1296 328 002</p>	<p><b>Packaging Unit:</b> 1</p> <p><b>Model:</b></p>
<p><b>T15072</b></p> 	<p><b>Description:</b> SYNCHRO RING (63T.)</p> <p><b>OEM No :</b> 1268 304 525</p> <p><b>EX / CROSS :</b> 1310 304 096</p>	<p><b>Packaging Unit:</b> 1</p> <p><b>Model:</b></p>
<p><b>T08874</b></p> 	<p><b>Description:</b> SYNCHRO RING (63T.)</p> <p><b>OEM No :</b> 1296 304 135</p> <p><b>EX / CROSS :</b> 1246 304 278</p>	<p><b>Packaging Unit:</b> 1</p> <p><b>Model:</b></p>
<p><b>T08845</b></p> 	<p><b>Description:</b> SYNCHRO RING (63T.)</p> <p><b>OEM No :</b> 1269 328 254</p> <p><b>EX / CROSS :</b> 1269 328 245</p>	<p><b>Packaging Unit:</b> 1</p> <p><b>Model:</b></p>
<p><b>T09055</b></p> 	<p><b>Description:</b> SYNCHRO RING (63T.)</p> <p><b>OEM No :</b> 1269 328 289</p> <p><b>EX / CROSS :</b></p>	<p><b>Packaging Unit:</b> 1</p> <p><b>Model:</b></p>













<p><b>T18028</b></p> 	<p><b>Description:</b> SYNCHRO RING (63T.)</p> <p><b>OEM No :</b> 1297 304 485</p> <p><b>EX / CROSS :</b> 1297 304 401 1297 304 373</p>	<p><b>Packaging Unit:</b> 1</p> <p><b>Model:</b> 16S 112/1 16S 130/1 16S 150 16S 151 16S 160/1 16S 160A/1 16S 1650 16S 181 16S 182 16S 190/1 16S 190A/1 16S 220</p> <p>16S 221 16S 251 6S 1600 6S 1600 KMZ 6S 1600BD 6S 1601BD IT 6S 1700BO 6S 1701BO IT 6S 1701BO XAM 6S 1900BO 6S 1900BO HYU 6S 1901BO IT</p>
<p><b>T08860</b></p> 	<p><b>Description:</b> SYNCHRO RING (63T.)</p> <p><b>OEM No :</b> 1250 304 472</p> <p><b>EX / CROSS :</b> 1250 304 391 1250 304 535</p>	<p><b>Packaging Unit:</b> 1</p> <p><b>Model:</b></p>
<p><b>T17873</b></p> 	<p><b>Description:</b> SYNCHRO RING (63T.) (MOLYBDENUM)</p> <p><b>OEM No :</b> 1316 304 170</p> <p><b>EX / CROSS :</b> 1316 304 150 1316 304 173/M</p>	<p><b>Packaging Unit:</b> 1</p> <p><b>Model:</b> 16S 150 16S 151 16S 151 IVE 16S 1620TD 16S 1621TD IT 16S 1625TD 16S 162TD IT 16S 1630TD 16S 1631TD IT 16S 163TD IT 16S 1650 16S 1650 IVE</p> <p>16S 1650 MAZ 16S 1685 16S 181 16S 1820TO 16S 1821TO IT 16S 1822TO 16S 1823TO 16S 1825TO 16S 182TD IT 16S 1833TO 16S 1920TD 16S 1921TD IT</p>
<p><b>T09562</b></p> 	<p><b>Description:</b> SYNCHRO RING (66T.)</p> <p><b>OEM No :</b> 1307 304 181</p> <p><b>EX / CROSS :</b> 1307 304 159</p>	<p><b>Packaging Unit:</b> 1</p> <p><b>Model:</b> S5 42 S5 420</p>
<p><b>T57450</b></p> 	<p><b>Description:</b> SYNCHRO RING (82T.)</p> <p><b>OEM No :</b> 1358 332 222</p> <p><b>EX / CROSS :</b> 1328 332 011 1328 332 046</p>	<p><b>Packaging Unit:</b> 1</p> <p><b>Model:</b> 10AS 2010B IT 10AS 2300BO 10AS 2310B 10AS 2310B IT 10AS 2700BO 12AS 1601BO IT 12AS 1630TD 12AS 1631TD IT 12AS 1930TD 12AS 1930TO 12AS 1931TD IT 12AS 1931TO IT</p> <p>12AS 1935TD 12AS 2000B IT 12AS 2000BO 12AS 2001BO IT 12AS 2130TD 12AS 2130TO 12AS 2131TD IT 12AS 2131TO IT 12AS 2140TD 12AS 2300B IT 12AS 2300BO 12AS 2301</p>

<p><b>T38521</b></p> 	<p><b>Description:</b> SYNCHRO RING (CARBON FIBER)</p> <p><b>Packaging Unit:</b> 1</p> <p><b>OEM No :</b> 1316 304 173</p> <p><b>EX / CROSS :</b></p> <p><b>Model:</b> 16S 1620TD 16S 1621TD IT 16S 1622TD IT 16S 1630TD 16S 1631TD IT 16S 1635TD 16S 1635TD IT 16S 1820TO 16S 1820TO RVI 16S 1821TO IT 16S 1822TO 16S 1823TO</p> <p>16S 1825TO 16S 1827TO IT 16S 1830TO 16S 1831TO IT 16S 1833TO 16S 1835TO 16S 1837TO IT 16S 1920TD 16S 1921TD IT 16S 1922TD 16S 1923TD 16S 1925TD</p>
<p><b>T38519</b></p> 	<p><b>Description:</b> SYNCHRO RING (CARBON FIBER)</p> <p><b>Packaging Unit:</b> 1</p> <p><b>OEM No :</b> 1316 304 196</p> <p><b>EX / CROSS :</b></p> <p><b>Model:</b> 16S 1620TD 16S 1621TD IT 16S 1625TD 16S 1627TD IT 16S 1630TD 16S 1631TD IT 16S 1635TD 16S 1635TD IT 16S 1820TO 16S 1820TO RVI 16S 1821TO IT 16S 1822TO</p> <p>16S 1825TO 16S 1827TO IT 16S 1830TO 16S 1831TO IT 16S 1833TO 16S 1835TO 16S 1837TO IT 16S 1920TD 16S 1921TD IT 16S 1922TD 16S 1923TD 16S 1925TD</p>
<p><b>T15065</b></p> 	<p><b>Description:</b> SYNCHRO RING (ZF ORIGINAL)</p> <p><b>Packaging Unit:</b> 1</p> <p><b>OEM No :</b> 1268 304 494</p> <p><b>EX / CROSS :</b> 1268 304 491</p> <p><b>Model:</b></p>
<p><b>T22283</b></p> 	<p><b>Description:</b> SYNCHRO SLIDING SLEEVE</p> <p><b>Packaging Unit:</b> 1</p> <p><b>OEM No :</b> 1356 304 024</p> <p><b>EX / CROSS :</b></p> <p><b>Model:</b> 16S 150 16S 151 16S 1620TD 16S 1621TD IT 16S 1625TD 16S 1627TD IT 16S 1630TD 16S 1631TD IT 16S 1635TD 16S 1637TD IT 16S 181 16S 1820TO</p> <p>16S 1820TO RVI 16S 1821TO IT 16S 1822TO 16S 1823TO 16S 1825TO 16S 1827TO IT 16S 1830TO 16S 1831TO IT 16S 1833TO 16S 1835TO 16S 1837TO IT 16S 1920TD</p>
<p><b>T75832</b></p> 	<p><b>Description:</b> SYNCHRO SLIDING SLEEVE</p> <p><b>Packaging Unit:</b> 1</p> <p><b>OEM No :</b> 1324 304 050</p> <p><b>EX / CROSS :</b> 1336 304 049</p> <p><b>Model:</b> 9S 1110TO</p>

<p><b>T77305</b></p> 	<p><b>Description:</b> SYNCHRO SLIDING SLEEVE</p> <p><b>OEM No :</b> 1336 304 011</p> <p><b>EX / CROSS :</b></p>	<p><b>Packaging Unit:</b> 1</p> <p><b>Model:</b> 12AS 1210TO 12AS 1220TD 12AS 1420TD 12AS 1420TO 12AS 1620TO AS Tronic</p>
<p><b>T64683</b></p> 	<p><b>Description:</b> SYNCHRO SLIDING SLEEVE</p> <p><b>OEM No :</b> 1297 304 450</p> <p><b>EX / CROSS :</b> 1297 304 372 1297 304 415</p>	<p><b>Packaging Unit:</b> 1</p> <p><b>Model:</b> 16S 112/1 16S 130/1 16S 160/1 16S 160A/1 16S 190/1 16S 190A/1</p>
<p><b>T77125</b></p> 	<p><b>Description:</b> SYNCHRO SLIDING SLEEVE</p> <p><b>OEM No :</b> 1308 304 087</p> <p><b>EX / CROSS :</b> 1307 304 114</p>	<p><b>Packaging Unit:</b> 1</p> <p><b>Model:</b> 6AS 1000TO 6AS 1005TO 6AS 1010 BO 6AS 1110BO 6AS 700TO 6AS 800TO 6AS 805TO 6S 1000TO 6S 1005TO 6S 1010BO 6S 800TO 9S 75</p> <p>AS Tronic</p>
<p><b>T63098</b></p> 	<p><b>Description:</b> SYNCHRO SLIDING SLEEVE</p> <p><b>OEM No :</b> 1290 304 383</p> <p><b>EX / CROSS :</b> 1290 304 090 1290 304 190 1290 304 412</p>	<p><b>Packaging Unit:</b> 1</p> <p><b>Model:</b> 6AS 1000TO 6AS 1005TO 6AS 1010 BO 6AS 1110BO 6AS 800TO 6AS 805TO 6S 1000TO 6S 1005TO 6S 1010BO 6S 850 AS Tronic S5 680</p> <p>S5 680 SSO S6 36 S6 36+GV36 S6 36/2</p>
<p><b>T76062</b></p> 	<p><b>Description:</b> SYNCHRO SLIDING SLEEVE</p> <p><b>OEM No :</b> 1358 302 283</p> <p><b>EX / CROSS :</b></p>	<p><b>Packaging Unit:</b> 1</p> <p><b>Model:</b> 12 TX 1410 TD IT (1372 001 023) 12 TX 1410 TD IT (1372 001 030) 12 TX 1410 TO (1372 002 019) 12 TX 1411 TD IT (1372 040 027) 12 TX 1411 TD IT (1372 040 028) 12 TX 1411 TD IT (1372 040 029) 12 TX 1411 TO IT (1372 041 017) 12 TX 1611 BO IT (1372 044 050) 12 TX 1611 BO IT (1372 044 051) 12 TX 1611 BO IT (1372 044 071) 12 TX 1611 BO IT (1372 044 075) 12 TX 1611 TO IT (1372 041 015) 12 TX 1611 TO IT (1372 041 016) 12 TX 1810 TD IT (1372 001 024)</p>



<p><b>T69916</b></p> 	<p><b>Description:</b> SYNCHRO SLIDING SLEEVE</p> <p><b>OEM No :</b> 6002 305 994</p> <p><b>EX / CROSS :</b> 1290 304 440</p> <p><b>Model:</b> 16S 109 6S 1000TO 6S 700BO 6S 800TO 6S 850 6S 890 8S 109 9S 109 S5 680 S6 36</p>	<p><b>Packaging Unit:</b> 1</p>
<p><b>T80358</b></p> 	<p><b>Description:</b> SYNCHRO SLIDING SLEEVE</p> <p><b>OEM No :</b> 1308 332 015</p> <p><b>EX / CROSS :</b></p> <p><b>Model:</b> 9S 75</p>	<p><b>Packaging Unit:</b> 1</p>
<p><b>T08859</b></p> 	<p><b>Description:</b> SYNCHRO SLIDING SLEEVE (18T.)</p> <p><b>OEM No :</b> 1269 304 069</p> <p><b>EX / CROSS :</b></p> <p><b>Model:</b></p>	<p><b>Packaging Unit:</b> 1</p>
<p><b>T08578</b></p> 	<p><b>Description:</b> SYNCHRO SLIDING SLEEVE (19T.)</p> <p><b>OEM No :</b> 1250 304 141</p> <p><b>EX / CROSS :</b> 1250 304 050</p> <p><b>Model:</b></p>	<p><b>Packaging Unit:</b> 1</p>
<p><b>T08486</b></p> 	<p><b>Description:</b> SYNCHRO SLIDING SLEEVE (19T.)</p> <p><b>OEM No :</b> 1250 304 362</p> <p><b>EX / CROSS :</b> 1250 304 484</p> <p><b>Model:</b></p>	<p><b>Packaging Unit:</b> 1</p>

<p><b>T09777</b></p> 	<p><b>Description:</b> SYNCHRO SLIDING SLEEVE (22T.)</p> <p><b>OEM No :</b> 1297 304 119</p> <p><b>EX / CROSS :</b></p>	<p><b>Packaging Unit:</b> 1</p> <p><b>Model:</b></p>
<p><b>T08579</b></p> 	<p><b>Description:</b> SYNCHRO SLIDING SLEEVE (22T.)</p> <p><b>OEM No :</b> 1250 304 306</p> <p><b>EX / CROSS :</b></p>	<p><b>Packaging Unit:</b> 1</p> <p><b>Model:</b></p>
<p><b>T15388</b></p> 	<p><b>Description:</b> SYNCHRO SLIDING SLEEVE (22T.)</p> <p><b>OEM No :</b> 1269 304 017</p> <p><b>EX / CROSS :</b></p>	<p><b>Packaging Unit:</b> 1</p> <p><b>Model:</b></p>
<p><b>T20038</b></p> 	<p><b>Description:</b> SYNCHRO SLIDING SLEEVE (22T.)</p> <p><b>OEM No :</b> 1250 304 441</p> <p><b>EX / CROSS :</b></p>	<p><b>Packaging Unit:</b> 1</p> <p><b>Model:</b> 5K 90GP 5K 90GPA 5K 91GP 5K 91GPA AK6 65 AK6 65+GV80 AK6 80 AK6 80+GV80 AK6 90 AK6 90+GV90</p>
<p><b>T08459</b></p> 	<p><b>Description:</b> SYNCHRO SLIDING SLEEVE (22T.)</p> <p><b>OEM No :</b> 1250 304 233</p> <p><b>EX / CROSS :</b> 1250 304 485</p>	<p><b>Packaging Unit:</b> 1</p> <p><b>Model:</b></p>



**Description:** SYNCHRO SLIDING SLEEVE (22T.) **Packaging Unit:** 1

**OEM No :** 1292 304 025 **Model:**

**EX / CROSS :**



**Description:** SYNCHRO SLIDING SLEEVE (23SPL.) **Packaging Unit:** 1

**OEM No :** 1297 304 120 **Model:**

**EX / CROSS :**



**Description:** SYNCHRO SLIDING SLEEVE (24T.) **Packaging Unit:** 1

**OEM No :** 1304 304 444 **Model:** 8S 140  
9S 109  
9S 109 MAN  
9S 109 SNVI  
9S 1110TD  
9S 1110TO  
9S 1111TD IT  
9S 1111TO IT  
9S 1115TD  
9S 1115TO  
9S 1310TO  
9S 1310TO KMZ  
9S 1311TO IT  
9S 1315TO

**EX / CROSS :**



**Description:** SYNCHRO SLIDING SLEEVE (27T.) **Packaging Unit:** 1

**OEM No :** 1250 304 236 **Model:**

**EX / CROSS :**







**Description:** SYNCHRO SLIDING SLEEVE (27T.) **Packaging Unit:** 1

**OEM No :** 1250 304 004 **Model:**





**EX / CROSS :**















<p><b>T38931</b></p> 	<p><b>Description:</b> SYNCHRO SLIDING SLEEVE (45T.)</p> <p><b>OEM No :</b> 1238 304 390 <b>EX / CROSS :</b> 1238 304 357 1290 304 083 1290 304 417 1290 395 193</p>	<p><b>Packaging Unit:</b> 1</p> <p><b>Model:</b> S5 35/2 S5 680 S6 36 S6 36+GV36 S6 36/2 S6 680</p>
<p><b>T38320</b></p> 	<p><b>Description:</b> SYNCHRO SLIDING SLEEVE (45T.)</p> <p><b>OEM No :</b> 1304 304 688 <b>EX / CROSS :</b> 6002 304 852 6002 305 511</p>	<p><b>Packaging Unit:</b> 1</p> <p><b>Model:</b> 16S 109 16S 109 STR 8S 109</p>
<p><b>T08843</b></p> 	<p><b>Description:</b> SYNCHRO SLIDING SLEEVE (48T.)</p> <p><b>OEM No :</b> 1240 304 272 <b>EX / CROSS :</b> 1240 304 205 1240 312 073 1252 304 064</p>	<p><b>Packaging Unit:</b> 1</p> <p><b>Model:</b></p>
<p><b>T11836</b></p> 	<p><b>Description:</b> SYNCHRO SLIDING SLEEVE (48T.)</p> <p><b>OEM No :</b> 1346 304 090 <b>EX / CROSS :</b> 1333 304 061  1317 304 126</p>	<p><b>Packaging Unit:</b> 1</p> <p><b>Model:</b> 6S 700BO 6S 700BO KAVZ 6S 850 6S 850 DAF 6S 850 MAN 6S 890 S5 47 S6 650</p>
<p><b>T19735</b></p> 	<p><b>Description:</b> SYNCHRO SLIDING SLEEVE (48T.)</p> <p><b>OEM No :</b> 1304 304 664 <b>EX / CROSS :</b> 1311 304 011 1311 304 103</p>	<p><b>Packaging Unit:</b> 1</p> <p><b>Model:</b> 6AS 700TO 6AS 800TO 6AS 805TO 6S 1000BD 6S 1000BO 6S 1200BD 6S 1200BO 6S 1200BO IKA 6S 1200BO KMZ 6S 1200TD 6S 1200TO 6S 1205TD 6S 800TO 8S 180 8S 180 ENASA 8S 2100 8S 2100BD 8S 2100BO 8S 2101BD IT 8S 2101BO IT 9S 1110TD 9S 1110TO 9S 1111TD IT 9S 1111TO IT</p>



<p><b>T08866</b></p> 	<p><b>Description:</b> SYNCHRO SLIDING SLEEVE (51T.)</p> <p><b>Packaging Unit:</b> 1</p> <p><b>OEM No :</b> 1272 304 077</p> <p><b>Model:</b></p> <p><b>EX / CROSS :</b> 1250 304 167 1250 304 211 1250 304 293</p>
<p><b>T22325</b></p> 	<p><b>Description:</b> SYNCHRO SLIDING SLEEVE (51T.)</p> <p><b>Packaging Unit:</b> 1</p> <p><b>OEM No :</b> 1324 304 053</p> <p><b>Model:</b> 16S 109 6S 150C 8S 109 8S 140 8S 180 8S 2100BD 8S 2100BO 8S 2101BD IT 8S 2101BO IT 9S 109 9S 1110TD 9S 1110TO</p> <p><b>EX / CROSS :</b> 9S 1111TD IT 9S 1111TO IT 9S 1115TD 9S 1115TO 9S 1310TO 9S 1311TO IT 9S 1315TO S6 85</p>
<p><b>T09240</b></p> 	<p><b>Description:</b> SYNCHRO SLIDING SLEEVE (51T.)</p> <p><b>Packaging Unit:</b> 1</p> <p><b>OEM No :</b> 1240 304 375</p> <p><b>Model:</b></p> <p><b>EX / CROSS :</b> 1240 304 212 1240 304 238 1257 304 021</p>
<p><b>T08890</b></p> 	<p><b>Description:</b> SYNCHRO SLIDING SLEEVE (51T.)</p> <p><b>Packaging Unit:</b> 1</p> <p><b>OEM No :</b> 1285 333 020</p> <p><b>Model:</b></p> <p><b>EX / CROSS :</b> 1285 333 008</p>
<p><b>T38877</b></p> 	<p><b>Description:</b> SYNCHRO SLIDING SLEEVE (51T.)</p> <p><b>Packaging Unit:</b> 1</p> <p><b>OEM No :</b> 1310 304 195</p> <p><b>Model:</b> 6AS 1000TO 6AS 1005TO 6AS 1010 BO 6AS 1110BO 6S 1000TO 6S 1005TO 6S 1010BO 6S 1350 BO 6S 1600 6S 1600BD 6S 1601BD IT 6S 1700BO</p> <p><b>EX / CROSS :</b> 1311 312 043 1311 298 012 1311 212 024</p> <p>6S 1701BO IT 6S 1900BO 6S 1901BO IT AS Tronic S6 66 S6 66+GV66</p>

<p><b>T19795</b></p> 	<p><b>Description:</b> SYNCHRO SLIDING SLEEVE (51T.)</p> <p><b>OEM No :</b> 1311 304 177 <b>EX / CROSS :</b> 1311 304 102 1304 304 597 1304 304 541 1304 304 062</p> <p><b>Model:</b> 16S 109 16S 109 STR 6S 150C 6S 1600 8S 109 8S 140 8S 180 8S 180 ENASA 8S 2100 8S 2100BD 8S 2100BO 8S 2101BD IT</p>	<p><b>Packaging Unit:</b> 1</p> <p>8S 2101BO IT 9S 109 9S 109 MAN 9S 109 SNVI 9S 1110TD 9S 1110TO 9S 1111TD IT 9S 1111TO IT 9S 1115TD 9S 1115TO 9S 1310TO 9S 1310TO KMZ</p>
<p><b>T11835</b></p> 	<p><b>Description:</b> SYNCHRO SLIDING SLEEVE (54T.)</p> <p><b>OEM No :</b> 1317 304 157 <b>EX / CROSS :</b> 1317 304 125</p> <p><b>Model:</b> 6AS 700TO 6S 700BO 6S 700BO KAVZ 6S 850 6S 850 DAF 6S 850 MAN 6S 890 AS Tronic S5 47 S6 650</p>	<p><b>Packaging Unit:</b> 1</p>
<p><b>T22282</b></p> 	<p><b>Description:</b> SYNCHRO SLIDING SLEEVE (57T.)</p> <p><b>OEM No :</b> 1356 304 023 <b>EX / CROSS :</b> 1316 304 188</p> <p><b>Model:</b> 12S 2130TD 12S 2131TD IT 12S 2133TD 12S 2330TD 12S 2331TD IT 12S 2333TD 12S 2333TD IT 12S 2830TD 12S 2831TD IT 12S 2833TD 12S 2833TD IT 16S 150</p>	<p><b>Packaging Unit:</b> 1</p> <p>16S 151 16S 151PTO HIN 16S 1620TD 16S 1621TD IT 16S 1625TD 16S 1627TD IT 16S 1630TD 16S 1631TD IT 16S 1635TD 16S 1637TD IT 16S 181 16S 1820TO</p>
<p><b>T09056</b></p> 	<p><b>Description:</b> SYNCHRO SLIDING SLEEVE (57T.)</p> <p><b>OEM No :</b> 1295 304 002 <b>EX / CROSS :</b></p> <p><b>Model:</b></p>	<p><b>Packaging Unit:</b> 1</p>
<p><b>T17870</b></p> 	<p><b>Description:</b> SYNCHRO SLIDING SLEEVE (57T.)</p> <p><b>OEM No :</b> 1316 304 167 <b>EX / CROSS :</b> 1315 304 135 1297 304 515 0769 186 281</p> <p><b>Model:</b> 16S 150 16S 151 16S 151 IVE 16S 151 MAN 16S 151PTO HIN 16S 1650 IVE 16S 1685 16S 181 16S 1820TO KMZ 16S 1920TD 16S 1921TD IT 16S 1922TD</p>	<p><b>Packaging Unit:</b> 1</p> <p>16S 1923TD 16S 220 16S 220A 16S 221 16S 2280TO 16S 251 6S 1200TD 6S 1205TD 6S 1350 BO Ecosplit III</p>

<p><b>T14983</b></p> 	<p><b>Description:</b> SYNCHRO SLIDING SLEEVE (57T.)</p> <p><b>OEM No :</b> 1310 304 202</p> <p><b>EX / CROSS :</b> 1310 304 174 1316 304 225 1310 304 225 1312 302 055</p>	<p><b>Packaging Unit:</b> 1</p> <p><b>Model:</b></p>
<p><b>T19816</b></p> 	<p><b>Description:</b> SYNCHRO SLIDING SLEEVE (60T.)</p> <p><b>OEM No :</b> 1304 332 089</p> <p><b>EX / CROSS :</b></p>	<p><b>Packaging Unit:</b> 1</p> <p><b>Model:</b> 16S 109 16S 109 STR 6S 150C 8S 109 8S 140 8S 180 8S 180 ENASA 9S 109 9S 109 MAN 9S 109 SNVI</p>
<p><b>T23755</b></p> 	<p><b>Description:</b> SYNCHRO SLIDING SLEEVE (60T.)</p> <p><b>OEM No :</b> 1307 304 671</p> <p><b>EX / CROSS :</b> 1307 304 544</p>	<p><b>Packaging Unit:</b> 1</p> <p><b>Model:</b> 5S 580 5S 600BO S5 42 S5 42 KAVZ S5 42 KMZ S5 42 MAZ</p>
<p><b>T18371</b></p> 	<p><b>Description:</b> SYNCHRO SLIDING SLEEVE (60T.)</p> <p><b>OEM No :</b> 1307 304 669</p> <p><b>EX / CROSS :</b> 1307 304 371 1307 304 190</p>	<p><b>Packaging Unit:</b> 1</p> <p><b>Model:</b> S5 42 SNVI S5 420</p>
<p><b>T10069</b></p> 	<p><b>Description:</b> SYNCHRO SLIDING SLEEVE (60T.)</p> <p><b>OEM No :</b> 1307 304 372</p> <p><b>EX / CROSS :</b> 1307 304 188 1307 304 670</p>	<p><b>Packaging Unit:</b> 1</p> <p><b>Model:</b> S5 42 S5 420</p>



**Description:** SYNCHRO SLIDING SLEEVE (63T.) **Packaging Unit:** 1

**OEM No :** 1310 304 175 **Model:**

**EX / CROSS :** 1312 304 107  
1312 304 157  
1312 304 102



**Description:** SYNCHRO SLIDING SLEEVE (63T.) **Packaging Unit:** 1

**OEM No :** 1269 333 047 **Model:**

**EX / CROSS :** 1269 333 018  
1269 333 024  
1295 333 012



**Description:** SYNCHRO SLIDING SLEEVE (63T.) **Packaging Unit:** 1

**OEM No :** 1296 333 023 **Model:**

**EX / CROSS :** 1296 333 011  
0769 186 286  
1297 333 139



**Description:** SYNCHRO SLIDING SLEEVE (63T.) **Packaging Unit:** 1

**OEM No :** 1325 333 018 **Model:**

**EX / CROSS :**

12S 2130TD	16S 1621TD IT
12S 2131TD IT	16S 1625TD
12S 2133TD	16S 162TD IT
12S 2330TD	16S 1630TD
12S 2331TD IT	16S 1631TD IT
12S 2333TD	16S 1635TD
12S 233TD IT	16S 163TD IT
12S 2830TD	16S 1820TO
12S 2831TD IT	16S 1821TO IT
12S 2833TD	16S 182TO IT
12S 283TD IT	16S 1830TO
16S 1620TD	16S 1831TO IT



**Description:** SYNCHRO SLIDING SLEEVE (63T.) **Packaging Unit:** 1

**OEM No :** 1316 333 034 **Model:**





**EX / CROSS :**

16S 151	16S 1820TO RVI
16S 151 IVE	16S 1821TO IT
16S 151PTO HIN	16S 1822TO
16S 1620TD	16S 1823TO
16S 1621TD IT	16S 1825TO
16S 1625TD	16S 182TO IT
16S 162TD IT	16S 1920TD
16S 1685	16S 1921TD IT
16S 181	16S 1922TD
16S 182	16S 1923TD
16S 1820TO	16S 221
16S 1820TO KMZ	16S 221 VW





<p><b>T17872</b></p> 	<p><b>Description:</b> SYNCHRO SLIDING SLEEVE (63T.)</p> <p><b>Packaging Unit:</b> 1</p> <p><b>OEM No :</b> 1316 304 169 <b>EX / CROSS :</b> 1316 304 078 1315 304 136 1310 304 067 1310 304 063</p> <p><b>Model:</b> 16S 150 16S 151 16S 151 IVE 16S 1650 16S 1650 IVE 16S 1650 MAZ 16S 1685 16S 181 16S 1920TD 16S 1921TD IT 16S 1922TD 16S 220</p> <p>16S 220A 16S 221 16S 221 VW 16S 2280TO 16S 251 Ecosplit III</p>
<p><b>T19832</b></p> 	<p><b>Description:</b> SYNCHRO SLIDING SLEEVE (63T.)</p> <p><b>Packaging Unit:</b> 1</p> <p><b>OEM No :</b> 1304 333 011 <b>EX / CROSS :</b></p> <p><b>Model:</b> 16S 109 8S 109 8S 140 8S 180 8S 2100 8S 2100BD 8S 2100BO 8S 2101BD IT 8S 2101BO IT 9S 109 9S 1110TD 9S 1110TO</p> <p>9S 1111TD IT 9S 1111TO IT 9S 1115TD 9S 1115TO 9S 1310TO 9S 1310TO KMZ 9S 1310TO IT 9S 1315TO</p>
<p><b>T08946</b></p> 	<p><b>Description:</b> SYNCHRO SLIDING SLEEVE (63T.)</p> <p><b>Packaging Unit:</b> 1</p> <p><b>OEM No :</b> 1257 304 020 <b>EX / CROSS :</b> 1246 304 295 1250 304 160 1297 304 351</p> <p><b>Model:</b></p>
<p><b>T12124</b></p> 	<p><b>Description:</b> SYNCHRO SLIDING SLEEVE (66T.)</p> <p><b>Packaging Unit:</b> 1</p> <p><b>OEM No :</b> 1308 304 091 <b>EX / CROSS :</b> 1308 304 074</p> <p><b>Model:</b></p>
<p><b>T10068</b></p> 	<p><b>Description:</b> SYNCHRO SLIDING SLEEVE (66T.)</p> <p><b>Packaging Unit:</b> 1</p> <p><b>OEM No :</b> 1307 304 668 <b>EX / CROSS :</b> 1307 304 189 1307 304 370</p> <p><b>Model:</b> S5 42 SNVI S5 420</p>

<p><b>T64370</b></p> 	<p><b>Description:</b> SYNCHRONIZER HUB</p> <p><b>Packaging Unit:</b></p> <p><b>OEM No :</b> 1325 304 223</p> <p><b>EX / CROSS :</b></p> <p><b>Model:</b> 12S 2130TD 12S 2131TD IT 12S 2133TD 12S 2331TD IT 12S 2333TD 12S 2833TD 12S 283TD IT</p>
<p><b>T82036</b></p> 	<p><b>Description:</b> SYNCHRONIZER KIT</p> <p><b>Packaging Unit:</b> 1</p> <p><b>OEM No :</b> 1358 298 029</p> <p><b>EX / CROSS :</b></p> <p><b>Model:</b> 12 TX 1410 TO (1372 002 019) 12 TX 1411 TO IT (1372 041 017) 12 TX 1610 TO IT (1372 002 025) 12 TX 1610 TO IT (1372 002 045) 12 TX 1611 BO IT (1372 044 006) 12 TX 1611 BO IT (1372 044 033) 12 TX 1611 BO IT (1372 044 050) 12 TX 1810 TO (1372 002 018) 12 TX 1810 TO (1372 002 033) 12 TX 1810 TO (1372 002 037) 12 TX 1810 TO (1372 002 040) 12 TX 1811 TO IT (1372 041 018) 12 TX 1811 TO IT (1372 041 032) 12 TX 1811 TO IT (1372 041 034) 12 TX 1811 TO IT (1372 041 035) 12 TX 1811 TO IT (1372 041 044)</p>
<p><b>T82032</b></p> 	<p><b>Description:</b> SYNCHRONIZER RING</p> <p><b>Packaging Unit:</b> 1</p> <p><b>OEM No :</b> 1358 202 022</p> <p><b>EX / CROSS :</b></p> <p><b>Model:</b> 12 TX 1410 TO (1372 002 019) 12 TX 1411 TO IT (1372 041 017) 12 TX 1610 TO IT (1372 002 025) 12 TX 1610 TO IT (1372 002 045) 12 TX 1611 BO IT (1372 044 006) 12 TX 1611 BO IT (1372 044 033) 12 TX 1611 BO IT (1372 044 050) 12 TX 1810 TO (1372 002 018) 12 TX 1810 TO (1372 002 033) 12 TX 1810 TO (1372 002 037) 12 TX 1810 TO (1372 002 040) 12 TX 1811 TO IT (1372 041 018) 12 TX 1811 TO IT (1372 041 032) 12 TX 1811 TO IT (1372 041 034) 12 TX 1811 TO IT (1372 041 035) 12 TX 1811 TO IT (1372 041 044)</p>
<p><b>T22310</b></p> 	<p><b>Description:</b> T/M REPAIR GASKET KIT</p> <p><b>Packaging Unit:</b> 1</p> <p><b>OEM No :</b> (1324/GASKET M1)</p> <p><b>EX / CROSS :</b></p> <p><b>Model:</b></p>
<p><b>T47570</b></p> 	<p><b>Description:</b> TAPERED ROLLER BEARING (110X170X38)</p> <p><b>Packaging Unit:</b> 1</p> <p><b>OEM No :</b> 0635 370 030</p> <p><b>EX / CROSS :</b> 32022X VKHB 2281 SET 1052 0735 371 464</p> <p><b>Model:</b> 16S 160A 16S 160A/1 16S 190A 16S 190A/1 16S 220A</p>



<p><b>T56936</b></p> 	<p><b>Description:</b> TAPERED ROLLER BEARING (24X28,5)</p> <p><b>Packaging Unit:</b> 1</p> <p><b>OEM No :</b> 0750 117 251</p> <p><b>Model:</b> 5S 580</p> <p><b>EX / CROSS :</b> 0735 371 372 0735 370 513</p>
<p><b>T37644</b></p> 	<p><b>Description:</b> TAPERED ROLLER BEARING (28X32)</p> <p><b>Packaging Unit:</b> 1</p> <p><b>OEM No :</b> 0750 117 562</p> <p><b>Model:</b> 6S 1000BD 6S 1000BO 6S 1200BD 6S 1200BO 6S 1200BO IKA 6S 1200BO KMZ 6S 1200TD 6S 1200TO 6S 1205TD S6 85 S6 85 LIAZ S6 85 MAN</p> <p><b>EX / CROSS :</b> 0735 371 591 JXC 25665 CC 0735 371 375 0735 370 987</p> <p>S6 85 MAZ S6 85 NEFAZ</p>
<p><b>T23809</b></p> 	<p><b>Description:</b> TAPERED ROLLER BEARING (31,75X66,42X25,40)</p> <p><b>Packaging Unit:</b> 1</p> <p><b>OEM No :</b> 1307 203 019</p> <p><b>Model:</b> 5S 580 5S 600BO 9S 75 S5 42 S5 42 KAVZ S5 42 KMZ S5 42 MAZ S5 42 SNVI S5 420 S5 47</p> <p><b>EX / CROSS :</b> 1307 203 009 1307 203 010</p>
<p><b>T22221</b></p> 	<p><b>Description:</b> TAPERED ROLLER BEARING (32X29,5)</p> <p><b>Packaging Unit:</b> 1</p> <p><b>OEM No :</b> 0735 371 748</p> <p><b>Model:</b> 6S 150C 8S 140 9S 109 9S 109 MAN 9S 109 SNVI</p> <p><b>EX / CROSS :</b> JXC 25662 C 0750 117 080 0750 117 507</p>
<p><b>T23803</b></p> 	<p><b>Description:</b> TAPERED ROLLER BEARING (32X33)</p> <p><b>Packaging Unit:</b> 1</p> <p><b>OEM No :</b> 0735 371 406</p> <p><b>Model:</b> 16S 109 16S 109 STR 8S 109</p> <p><b>EX / CROSS :</b> BT1B 329154/Q/CL7C VKT 8957</p>



<p><b>T23286</b></p> 	<p><b>Description:</b> TAPERED ROLLER BEARING (35X28)</p> <p><b>Packaging Unit:</b> 1</p> <p><b>OEM No :</b> 0750 120 098</p> <p><b>Model:</b></p> <p><b>EX / CROSS :</b> HDB070 VKHB 2182 SET 1107</p>
<p><b>T22587</b></p> 	<p><b>Description:</b> TAPERED ROLLER BEARING (39,68X76,20X23,81)</p> <p><b>Packaging Unit:</b> 1</p> <p><b>OEM No :</b> 0735 370 438</p> <p><b>Model:</b> 6S 700BO 6S 700BO KAVZ 6S 850 6S 850 DAF 6S 850 MAN 6S 890 9S 75 S5 680 S6 36 S6 36+GV36 S6 36/2</p> <p><b>EX / CROSS :</b> 0750 117 198 1290 203 017</p>
<p><b>T22338</b></p> 	<p><b>Description:</b> TAPERED ROLLER BEARING (40X80X21)</p> <p><b>Packaging Unit:</b> 1</p> <p><b>OEM No :</b> 0735 371 607</p> <p><b>Model:</b> 6S 700BO 6S 700BO KAVZ 6S 850 6S 850 DAF 6S 890 S6 36 S6 36+GV36 S6 36/2</p> <p><b>EX / CROSS :</b> 0750 117 110 0750 117 199 1290 203 018</p>
<p><b>T22670</b></p> 	<p><b>Description:</b> TAPERED ROLLER BEARING (40X80X32)</p> <p><b>Packaging Unit:</b> 1</p> <p><b>OEM No :</b> 0735 371 749</p> <p><b>Model:</b> 16S 109 16S 109 STR 6S 150C 8S 109 8S 140 9S 109 9S 109 MAN 9S 109 SNVI</p> <p><b>EX / CROSS :</b> VKHB 2065 SET 1108 0635 376 023 0735 300 509</p>
<p><b>T22212</b></p> 	<p><b>Description:</b> TAPERED ROLLER BEARING (40X85X33)</p> <p><b>Packaging Unit:</b> 1</p> <p><b>OEM No :</b> 0735 371 096</p> <p><b>Model:</b> 8S 180 8S 180 ENASA 8S 2100 8S 2100BD 8S 2100BO 8S 2101BD IT 8S 2101BO IT 9S 1110TD 9S 1110TO 9S 1111TD IT 9S 1111TO IT 9S 1115TD</p> <p><b>EX / CROSS :</b> SET 238 0750 117 881</p> <p>9S 1115TO 9S 1310TO 9S 1311TO IT 9S 1315TO</p>



**Description:** TAPERED ROLLER BEARING (42,07X40,30) **Packaging Unit:** 1

**OEM No :** 0735 371 563

**EX / CROSS :** K4369  
VKT 8956  
0735 371 232  
0750 117 232

**Model:** 16S 151 DAF  
16S 151 HIN  
16S 151 HYU  
16S 151 IVE  
16S 151 KMZ  
16S 151 MAN  
16S 151 RVI  
16S 151 SNVI  
16S 151IT DAF  
16S 151PTO HIN  
16S 181 IVE  
16S 181 MAN

16S 181 RVI  
16S 181IT DAF  
16S 1820TO KMZ  
16S 1820TO RVI  
16S 221 DAF  
16S 221 IVE  
16S 221 MAN  
16S 221 MB  
16S 221 RVI  
16S 221 VW  
16S 221IT IVE  
16S 221IT RVI



**Description:** TAPERED ROLLER BEARING (42X92X24,6) **Packaging Unit:** 1

**OEM No :** 1307 204 275

**EX / CROSS :** 1307 204 056

**Model:** 5S 580  
5S 600BO  
S5 42  
S5 420  
S5 47



**Description:** TAPERED ROLLER BEARING (45X100X38,25) **Packaging Unit:** 1

**OEM No :** 0750 117 778

**EX / CROSS :** 0750 117 524  
0635 374 019  
VKHB 2004  
SET 1078

**Model:** AK6 90  
AK6 90+GV90  
S6 90  
S6 90 SETRA  
S6 90+GV90  
S6 90+GV90 SNVI  
S6 90/1  
S6 90/1+GV90



**Description:** TAPERED ROLLER BEARING (45X85X24,75) **Packaging Unit:** 1

**OEM No :** 0635 373 021

**EX / CROSS :** VKHB 2015  
SET 1058  
0635 373 004  
0735 370 282

**Model:** 16S 151  
16S 1625TD  
16S 181  
16S 1831TO IT  
16S 1835TO  
16S 1931TD IT  
16S 1935TD  
16S 221  
16S 2235TD  
16S 2235TO  
16S 2320TD  
16S 2321TD IT

16S 2325TD  
16S 232TD IT  
16S 251  
16S 2535TO  
4S 120GP  
5K 110GPA  
5K 110GPA+GV90  
5K 90GPA  
5K 91GPA  
5S 110GPA  
5S 110GPA+GV90  
5S 111GPA













**Description:** TAPERED ROLLER BEARING (45X85X32) **Packaging Unit:** 1





**OEM No :** 0735 371 994

**EX / CROSS :** 201052  
VKHB 2067  
VKHB 2249  
SET 1109

**Model:** 6AS 1000TO  
6AS 1005TO  
6AS 1010 BO  
6AS 1110BO  
6AS 800TO  
6AS 805TO  
6S 1000TO  
6S 1005TO  
6S 1010BO  
6S 800TO  
AS Tronic

<p><b>T37914</b></p> 	<p><b>Description:</b> TAPERED ROLLER BEARING (48,98X67,97X17,50) <b>Packaging Unit:</b> 1</p> <p><b>OEM No :</b> 0735 371 268 <b>Model:</b></p> <p><b>EX / CROSS :</b> VKHB 2272 SET 318</p>
<p><b>T22219</b></p> 	<p><b>Description:</b> TAPERED ROLLER BEARING (49,21X103,18X43,65) <b>Packaging Unit:</b> 1</p> <p><b>OEM No :</b> 0750 117 009 <b>Model:</b> 12S 2130TD 16S 151 DAF 12S 2131TD IT 16S 151 HIN 12S 2133TD 16S 151 HYU 12S 2330TD 16S 151 IVE 12S 2331TD IT 16S 151 KMZ 12S 2333TD 16S 151 MAN 12S 233TD IT 16S 151 RVI 12S 2830TD 16S 151 SNVI 12S 2831TD IT 16S 151T DAF 12S 2833TD 16S 151PTO HIN 12S 283TD IT 16S 160 16S 151</p> <p><b>EX / CROSS :</b> F-809306 SET 1133 0735 371 604 0735 372 156</p>
<p><b>T23878</b></p> 	<p><b>Description:</b> TAPERED ROLLER BEARING (50,80X104,07X30,10) <b>Packaging Unit:</b> 1</p> <p><b>OEM No :</b> 0750 117 081 <b>Model:</b> 16S 109 16S 109 STR 6S 150C 8S 109 8S 140 9S 109 9S 109 MAN 9S 109 SNVI</p> <p><b>EX / CROSS :</b> 0735 371 605</p>
<p><b>T57809</b></p> 	<p><b>Description:</b> TAPERED ROLLER BEARING (50,80X104,77X30,16) <b>Packaging Unit:</b> 1</p> <p><b>OEM No :</b> 0750 117 312 <b>Model:</b> 16S 220 16S 220A 9S 75</p> <p><b>EX / CROSS :</b> 0735 300 513</p>
<p><b>T22222</b></p> 	<p><b>Description:</b> TAPERED ROLLER BEARING (50,80X104,77X36,51) <b>Packaging Unit:</b> 1</p> <p><b>OEM No :</b> 0750 117 844 <b>Model:</b> 8S 180 8S 180 ENASA 8S 2100 8S 2100BD 8S 2100BO 8S 2101BD IT 8S 2101BO IT</p> <p><b>EX / CROSS :</b> 0735 371 599 0735 370 470</p>

<p><b>T22218</b></p> 	<p><b>Description:</b> TAPERED ROLLER BEARING (50,80X104,77X39,68)</p> <p><b>Packaging Unit:</b> 1</p> <p><b>OEM No :</b> 0750 117 011</p> <p><b>EX / CROSS :</b> VKT 8955 SET 1127 0735 370 059</p> <p><b>Model:</b> 16K 130 16S 112 16S 112/1 16S 150 16S 151 16S 151 HIN Ecosplit III</p>
<p><b>T22336</b></p> 	<p><b>Description:</b> TAPERED ROLLER BEARING (50,80X92,07X24,60)</p> <p><b>Packaging Unit:</b> 1</p> <p><b>OEM No :</b> 1307 202 116</p> <p><b>EX / CROSS :</b> 1307 202 018</p> <p><b>Model:</b> 5S 580 5S 600BO S5 42 S5 42 KAVZ S5 42 KMZ S5 42 MAZ S5 42 SNVI S5 420 S5 47</p>
<p><b>T22217</b></p> 	<p><b>Description:</b> TAPERED ROLLER BEARING (50,80X95,25X27,78)</p> <p><b>Packaging Unit:</b> 1</p> <p><b>OEM No :</b> 0750 117 083</p> <p><b>EX / CROSS :</b> SET 271 0635 501 357 0635 501 400 0735 300 512</p> <p><b>Model:</b> 10AS 2010B IT 10AS 2310B IT 12AS 1601BO IT 12AS 1631TD IT 12AS 1800IT 12AS 1931TD IT 12AS 1931TO IT 12AS 2000B IT 12AS 2001BO IT 12AS 2131TD IT 12AS 2131TO IT 12AS 2300B IT 12AS 2301BO IT 12AS 2301IT 12AS 2331TD IT 12AS 2331TO IT 12AS 2341TD IT 12AS 2531TO IT 12AS 2701BO IT 12AS 2741TO IT 12AS 2941TO IT 12AS 3001IT 16AS 2200TD IT 16AS 2231TD IT</p>
<p><b>T22207</b></p> 	<p><b>Description:</b> TAPERED ROLLER BEARING (50,8X100X35)</p> <p><b>Packaging Unit:</b> 1</p> <p><b>OEM No :</b> 0750 117 883</p> <p><b>EX / CROSS :</b> 0750 117 030 0750 117 010 0735 501 011 0735 370 058</p> <p><b>Model:</b> 16K 130 16K 160 16K 190 16S 112 16S 112/1 16S 130 16S 130/1 16S 1300 16S 150 16S 151 16S 160 16S 160/1 16S 1600 16S 160A 16S 160A/1 16S 1650 16S 1650 MAZ 16S 190 16S 190/1 16S 1900 16S 190A 16S 190A/1 16S 200 4S 150GP</p>
<p><b>T38138</b></p> 	<p><b>Description:</b> TAPERED ROLLER BEARING (50X110X29,25)</p> <p><b>Packaging Unit:</b> 1</p> <p><b>OEM No :</b> 0750 117 057</p> <p><b>EX / CROSS :</b> 31310A 0635 900 363</p> <p><b>Model:</b></p>

<p><b>T37803</b></p> 	<p><b>Description:</b> TAPERED ROLLER BEARING (50X110X42,25)</p> <p><b>Packaging Unit:</b> 1</p> <p><b>OEM No :</b> 0750 117 008</p> <p><b>EX / CROSS :</b> 32310A VKHB 2070 VKHB 2401 S 32310</p> <p><b>Model:</b> 16K 160 16K 190 16S 130 16S 130/1 16S 1300 16S 1650 16S 1650 IVE 16S 1650 MAZ 8S 1350 KMZ</p>
<p><b>T64195</b></p> 	<p><b>Description:</b> TAPERED ROLLER BEARING (50X90X24,75)</p> <p><b>Packaging Unit:</b> 1</p> <p><b>OEM No :</b> 0750 117 418</p> <p><b>EX / CROSS :</b> 0750 117 651</p> <p><b>Model:</b> G3/65-8/9,29 G3/65-9/13,36 G3/90-8/9,29 G56-6 G70-6 HL 1/2-3,3 HL 1/8-4,7 HL 1/9-5,6 HL O/01 C-3,2 HL O/14 C-1,7 HL O/15 C-2,2 HL O/3-3,3 HL O/6-3,9</p>
<p><b>T23885</b></p> 	<p><b>Description:</b> TAPERED ROLLER BEARING (50X90X28)</p> <p><b>Packaging Unit:</b> 1</p> <p><b>OEM No :</b> 0750 117 640</p> <p><b>EX / CROSS :</b> VKHB 2023 SET 315</p> <p><b>Model:</b> 10AS 2010B IT 10AS 2300BO 10AS 2310B 10AS 2310B IT 10AS 2700BO 12AS 1601BO IT 12AS 1630TD 12AS 1631TD IT 12AS 1800 12AS 1800IT 12AS 1930TD 12AS 1930TO 12AS 1931TD IT 12AS 1935TD 12AS 2000B IT 12AS 2000BO 12AS 2001BO IT 12AS 2130TD 12AS 2130TO 12AS 2131TD IT 12AS 2131TO IT 12AS 2140TD 12AS 2300B IT</p>
<p><b>T47396</b></p> 	<p><b>Description:</b> TAPERED ROLLER BEARING (60X110X29,75)</p> <p><b>Packaging Unit:</b> 1</p> <p><b>OEM No :</b> 0635 373 008</p> <p><b>EX / CROSS :</b> 32212A VKHB 2347 VKT 8690 SET 1061</p> <p><b>Model:</b> 5K 90GPA 5K 91GPA 5S 90GPA</p>
<p><b>T59348</b></p> 	<p><b>Description:</b> TAPERED ROLLER BEARING (65X105X24)</p> <p><b>Packaging Unit:</b> 1</p> <p><b>OEM No :</b> 0750 117 892</p> <p><b>EX / CROSS :</b> SET 342 0750 117 210</p> <p><b>Model:</b></p>

**T56247**



**Description:**

TAPERED ROLLER BEARING (65X140X36)

**Packaging Unit:** 1

**OEM No :**

0750 117 529

**Model:**

**EX / CROSS :**

0750 117 332

0735 372 213

0735 370 298

0635 375 007

**T22659**



**Description:**

TAPERED ROLLER BEARING (66,67X117,47X30,16)

**Packaging Unit:** 1

**OEM No :**

0750 117 079

**Model:**

16S 109  
16S 109 STR  
6S 150C  
8S 109  
8S 140  
9S 109  
9S 109 MAN  
9S 109 SNVI

**EX / CROSS :**

0735 370 233

**T49029**



**Description:**

TAPERED ROLLER BEARING (70X150X35)

**Packaging Unit:** 1

**OEM No :**

0735 300 495

**Model:**

**EX / CROSS :**

SET 1034

**T22215**



**Description:**

TAPERED ROLLER BEARING (71,44X120X32,55)

**Packaging Unit:** 1

**OEM No :**

0750 117 518

**Model:**

6S 1350 BO	8S 180 ENASA
6S 1600	8S 2100
6S 1600 KMZ	8S 2100BD
6S 1600BD	8S 2100BO
6S 1601BD IT	8S 2101BD IT
6S 1700BO	8S 2101BO IT
6S 1701BO IT	9S 1110TD
6S 1701BO XAM	9S 1115TD
6S 1900BO	9S 1310TO
6S 1900BO HYU	9S 1310TO KMZ
6S 1901BO IT	9S 1315TO
8S 180	

**EX / CROSS :**

K47490-47420

SET 928

0735 370 297

**T61822**



**Description:**

TAPERED ROLLER BEARING (75X130X27,25)

**Packaging Unit:** 1

**OEM No :**

0735 370 216

**Model:**





**EX / CROSS :**

0735 301 601





0750 117 799

0750 120 334



<p><b>T38142</b></p> 	<p><b>Description:</b> TAPERED ROLLER BEARING (80X130X36)</p> <p><b>Packaging Unit:</b> 1</p> <p><b>OEM No :</b> 0750 117 677</p> <p><b>EX / CROSS :</b> 575194 0750 117 403</p> <p><b>Model:</b> 12S 2130TD 12S 2131TD IT 12S 2133TD 16S 150 16S 151 16S 151 DAF 16S 151 HIN 16S 151 HYU 16S 151 IVE 16S 151 KMZ 16S 151 MAN 16S 151 RVI</p> <p>16S 151 SNVI 16S 151IT DAF 16S 151PTO HIN 16S 1620TD 16S 1621TD IT 16S 1625TD 16S 162TD IT 16S 1630TD 16S 1631TD IT 16S 1635TD 16S 163TD IT 16S 1820TO</p>
<p><b>T22208</b></p> 	<p><b>Description:</b> TAPERED ROLLER BEARING (80X140X36,5)</p> <p><b>Packaging Unit:</b> 1</p> <p><b>OEM No :</b> 0750 117 678</p> <p><b>EX / CROSS :</b> 568742A 0750 117 402</p> <p><b>Model:</b> 12S 2330TD 12S 2331TD IT 12S 2333TD 12S 233TD IT 12S 2830TD 12S 2831TD IT 12S 2833TD 12S 283TD IT 16S 1685 16S 181 16S 181 IVE 16S 181 MAN</p> <p>16S 181 RVI 16S 181IT DAF 16S 182 16S 1920TD 16S 1921TD IT 16S 1922TD 16S 1923TD 16S 1925TD 16S 1930TD 16S 1931TD IT 16S 1933TD 16S 1935TD</p>
<p><b>T22210</b></p> 	<p><b>Description:</b> TAPERED ROLLER BEARING (80X140X46)</p> <p><b>Packaging Unit:</b> 1</p> <p><b>OEM No :</b> 5841 300 574</p> <p><b>EX / CROSS :</b> VKHB 2232 SET 1116</p>
<p><b>T22214</b></p> 	<p><b>Description:</b> TAPERED ROLLER BEARING (85X150X30,5)</p> <p><b>Packaging Unit:</b> 1</p> <p><b>OEM No :</b> 0750 117 732</p> <p><b>EX / CROSS :</b> F-803621 30217 VKHB 2334 VKT 8490</p> <p><b>Model:</b> 12S 2130TD 12S 2131TD IT 12S 2133TD 12S 2330TD 12S 2331TD IT 12S 2333TD 12S 233TD IT 12S 2830TD 12S 2831TD IT 12S 2833TD 12S 283TD IT 16S 151</p> <p>16S 151 DAF 16S 151 HIN 16S 151 HYU 16S 151 IVE 16S 151 KMZ 16S 151 MAN 16S 151 RVI 16S 151 SNVI 16S 151IT DAF 16S 151PTO HIN 16S 1620TD 16S 1621TD IT</p>
<p><b>T08940</b></p> 	<p><b>Description:</b> THRUST WASHER</p> <p><b>Packaging Unit:</b> 10</p> <p><b>OEM No :</b> 0501 305 887</p> <p><b>EX / CROSS :</b></p>













<p><b>T53081</b></p> 	<p><b>Description:</b> THRUST WASHER</p> <p><b>OEM No :</b> 0730 109 323</p> <p><b>EX / CROSS :</b></p>	<p><b>Packaging Unit:</b> 10</p> <p><b>Model:</b> 10AS 2010B IT 10AS 2300BO 10AS 2310B 10AS 2310B IT 10AS 2700BO 12 TX 1410 TD IT (1372 001 023) 12 TX 1410 TD IT (1372 001 030) 12 TX 1410 TO (1372 002 019) 12 TX 1411 TD IT (1372 040 027) 12 TX 1411 TD IT (1372 040 028)</p> <p>12 TX 1415 TD IT (1372 001 026) 12 TX 1610 TO IT (1372 002 025) 12 TX 1610 TO IT (1372 002 045) 12 TX 1611 BO IT (1372 044 006) 12 TX 1611 BO IT (1372 044 033) 12 TX 1611 BO IT (1372 044 050) 12 TX 1611 BO IT (1372 044 051)</p>
<p><b>T38854</b></p> 	<p><b>Description:</b> THRUST WASHER</p> <p><b>OEM No :</b> 0730 107 168</p> <p><b>EX / CROSS :</b> 0730 102 412</p>	<p><b>Packaging Unit:</b> 15</p> <p><b>Model:</b> 12AS 1800 12AS 1800IT 12S 2130TD 12S 2131TD IT 12S 2133TD 16AS 2200TD 16AS 2200TD IT 16S 150 16S 151 16S 151 DAF 16S 151 HIN 16S 151 HYU</p> <p>16S 151 IVE 16S 151 KMZ 16S 151 MAN 16S 151 RWI 16S 151 SNVI 16S 151IT DAF 16S 151PTO HIN 16S 1620TD 16S 1621TD IT 16S 1625TD 16S 1625TD IT 16S 1630TD</p>
<p><b>T53087</b></p> 	<p><b>Description:</b> THRUST WASHER</p> <p><b>OEM No :</b> 0730 109 309</p> <p><b>EX / CROSS :</b></p>	<p><b>Packaging Unit:</b> 5</p> <p><b>Model:</b> 12S 2330TD 12S 2331TD IT 12S 2333TD 12S 2337TD IT 12S 2830TD 12S 2831TD IT 12S 2833TD 12S 2837TD IT 16S 1685 16S 181 16S 221 16S 2220TD</p> <p>16S 2221TD IT 16S 2222TD 16S 2223TD 16S 2225TD 16S 2227TD IT 16S 2230TD 16S 2231TD IT 16S 2233TD 16S 2235TD 16S 2237TD IT 16S 2280TO 16S 2320TD</p>
<p><b>T14283</b></p> 	<p><b>Description:</b> THRUST WASHER</p> <p><b>OEM No :</b> 0730 150 064</p> <p><b>EX / CROSS :</b></p>	<p><b>Packaging Unit:</b> 10</p> <p><b>Model:</b></p>
<p><b>T15920</b></p> 	<p><b>Description:</b> THRUST WASHER</p> <p><b>OEM No :</b> 0730 101 784</p> <p><b>EX / CROSS :</b></p>	<p><b>Packaging Unit:</b> 2</p> <p><b>Model:</b></p>





<p><b>T15922</b></p> 	<p><b>Description:</b> THRUST WASHER</p> <p><b>OEM No :</b> 4415 301 174</p> <p><b>EX / CROSS :</b></p>	<p><b>Packaging Unit:</b> 4</p> <p><b>Model:</b></p>																								
<p><b>T15921</b></p> 	<p><b>Description:</b> THRUST WASHER</p> <p><b>OEM No :</b> 0730 102 988</p> <p><b>EX / CROSS :</b></p>	<p><b>Packaging Unit:</b> 4</p> <p><b>Model:</b></p>																								
<p><b>T15745</b></p> 	<p><b>Description:</b> THRUST WASHER</p> <p><b>OEM No :</b> 0501 306 212</p> <p><b>EX / CROSS :</b></p>	<p><b>Packaging Unit:</b> 10</p> <p><b>Model:</b></p>																								
<p><b>T15928</b></p> 	<p><b>Description:</b> THRUST WASHER</p> <p><b>OEM No :</b> 4461 391 005</p> <p><b>EX / CROSS :</b></p>	<p><b>Packaging Unit:</b> 2</p> <p><b>Model:</b></p>																								
<p><b>T64456</b></p> 	<p><b>Description:</b> THRUST WASHER</p> <p><b>OEM No :</b> 0730 110 392</p> <p><b>EX / CROSS :</b></p>	<p><b>Packaging Unit:</b> 1</p> <p><b>Model:</b></p> <table border="0"> <tr> <td>10AS 2010B IT</td> <td>12AS 1931TD IT</td> </tr> <tr> <td>10AS 2300BO</td> <td>12AS 1931TO IT</td> </tr> <tr> <td>10AS 2310B</td> <td>12AS 1935TD</td> </tr> <tr> <td>10AS 2310B IT</td> <td>12AS 2000B IT</td> </tr> <tr> <td>10AS 2700BO</td> <td>12AS 2000BO</td> </tr> <tr> <td>12AS 1601BO IT</td> <td>12AS 2001BO IT</td> </tr> <tr> <td>12AS 1630TD</td> <td>12AS 2130TD</td> </tr> <tr> <td>12AS 1631TD IT</td> <td>12AS 2130TO</td> </tr> <tr> <td>12AS 1800</td> <td>12AS 2131TD IT</td> </tr> <tr> <td>12AS 1800IT</td> <td>12AS 2131TO IT</td> </tr> <tr> <td>12AS 1930TD</td> <td>12AS 2140TD</td> </tr> <tr> <td>12AS 1930TO</td> <td>12AS 2300B IT</td> </tr> </table>	10AS 2010B IT	12AS 1931TD IT	10AS 2300BO	12AS 1931TO IT	10AS 2310B	12AS 1935TD	10AS 2310B IT	12AS 2000B IT	10AS 2700BO	12AS 2000BO	12AS 1601BO IT	12AS 2001BO IT	12AS 1630TD	12AS 2130TD	12AS 1631TD IT	12AS 2130TO	12AS 1800	12AS 2131TD IT	12AS 1800IT	12AS 2131TO IT	12AS 1930TD	12AS 2140TD	12AS 1930TO	12AS 2300B IT
10AS 2010B IT	12AS 1931TD IT																									
10AS 2300BO	12AS 1931TO IT																									
10AS 2310B	12AS 1935TD																									
10AS 2310B IT	12AS 2000B IT																									
10AS 2700BO	12AS 2000BO																									
12AS 1601BO IT	12AS 2001BO IT																									
12AS 1630TD	12AS 2130TD																									
12AS 1631TD IT	12AS 2130TO																									
12AS 1800	12AS 2131TD IT																									
12AS 1800IT	12AS 2131TO IT																									
12AS 1930TD	12AS 2140TD																									
12AS 1930TO	12AS 2300B IT																									

<p><b>T39106</b></p> 	<p><b>Description:</b> THRUST WASHER (T.7,30)</p> <p><b>OEM No :</b> 1315 304 086</p> <p><b>EX / CROSS :</b></p>	<p><b>Packaging Unit:</b> 1</p> <p><b>Model:</b> 16S 151 DAF 16S 151 HIN 16S 151 HYU 16S 151 IVE 16S 151 KMZ 16S 151 MAN 16S 151 RVI 16S 151 SNVI 16S 151IT DAF 16S 151PTO HIN 16S 1620TD 16S 1621TD IT</p> <p>16S 1625TD 16S 162TD IT 16S 1630TD 16S 1631TD IT 16S 1635TD 16S 163TD IT 16S 1685 16S 181 IVE 16S 181 MAN 16S 181 RVI 16S 181IT DAF 16S 1820TO</p>
<p><b>T58475</b></p> 	<p><b>Description:</b> THRUST WASHER (T.7,50)</p> <p><b>OEM No :</b> 1315 304 043</p> <p><b>EX / CROSS :</b></p>	<p><b>Packaging Unit:</b> 1</p> <p><b>Model:</b> 16S 151 16S 1620TD 16S 1621TD IT 16S 1625TD 16S 162TD IT 16S 1630TD 16S 1631TD IT 16S 1635TD 16S 163TD IT 16S 1685 16S 181</p> <p>16S 1821TO IT 16S 182TO IT 16S 1830TO 16S 1831TO IT 16S 1833TO 16S 1835TO 16S 183TO IT 16S 1920TD 16S 1921TD IT 16S 1925TD 16S 1930TD 16S 1931TD IT</p> <p>16S 1820TO</p>
<p><b>T39103</b></p> 	<p><b>Description:</b> THRUST WASHER (T.7,70)</p> <p><b>OEM No :</b> 1315 304 045</p> <p><b>EX / CROSS :</b></p>	<p><b>Packaging Unit:</b> 1</p> <p><b>Model:</b> 16S 151 DAF 16S 151 HIN 16S 151 HYU 16S 151 IVE 16S 151 KMZ 16S 151 MAN 16S 151 RVI 16S 151 SNVI 16S 151IT DAF 16S 151PTO HIN 16S 1620TD 16S 1621TD IT</p> <p>16S 1625TD 16S 162TD IT 16S 1630TD 16S 1631TD IT 16S 1635TD 16S 163TD IT 16S 1685 16S 181 IVE 16S 181 MAN 16S 181 RVI 16S 181IT DAF 16S 1820TO</p>
<p><b>T39107</b></p> 	<p><b>Description:</b> THRUST WASHER (T.7,80)</p> <p><b>OEM No :</b> 1315 304 046</p> <p><b>EX / CROSS :</b></p>	<p><b>Packaging Unit:</b> 1</p> <p><b>Model:</b> 16S 151 DAF 16S 151 HIN 16S 151 HYU 16S 151 IVE 16S 151 KMZ 16S 151 MAN 16S 151 RVI 16S 151 SNVI 16S 151IT DAF 16S 151PTO HIN 16S 1620TD 16S 1621TD IT</p> <p>16S 1625TD 16S 162TD IT 16S 1630TD 16S 1631TD IT 16S 1635TD 16S 163TD IT 16S 1685 16S 181 IVE 16S 181 MAN 16S 181 RVI 16S 181IT DAF 16S 1820TO</p>
<p><b>T39104</b></p> 	<p><b>Description:</b> THRUST WASHER (T.7,90)</p> <p><b>OEM No :</b> 1315 304 047</p> <p><b>EX / CROSS :</b> 1312 304 060</p>	<p><b>Packaging Unit:</b> 1</p> <p><b>Model:</b> 16S 151 DAF 16S 151 HIN 16S 151 HYU 16S 151 IVE 16S 151 KMZ 16S 151 MAN 16S 151 RVI 16S 151 SNVI 16S 151IT DAF 16S 151PTO HIN 16S 1620TD 16S 1621TD IT</p> <p>16S 1625TD 16S 162TD IT 16S 1630TD 16S 1631TD IT 16S 1635TD 16S 163TD IT 16S 1685 16S 181 IVE 16S 181 MAN 16S 181 RVI 16S 181IT DAF 16S 1820TO</p>





<p><b>T39105</b></p> 	<p><b>Description:</b> THRUST WASHER (T.8,00)</p> <p><b>OEM No :</b> 1315 304 048</p> <p><b>EX / CROSS :</b></p>	<p><b>Packaging Unit:</b> 1</p> <p><b>Model:</b></p> <table border="0"> <tr><td>16S 151</td><td>16S 1621TD IT</td></tr> <tr><td>16S 151 DAF</td><td>16S 1625TD</td></tr> <tr><td>16S 151 HIN</td><td>16S 162TD IT</td></tr> <tr><td>16S 151 HYU</td><td>16S 1630TD</td></tr> <tr><td>16S 151 IVE</td><td>16S 1631TD IT</td></tr> <tr><td>16S 151 KMZ</td><td>16S 1635TD</td></tr> <tr><td>16S 151 MAN</td><td>16S 163TD IT</td></tr> <tr><td>16S 151 RVI</td><td>16S 1685</td></tr> <tr><td>16S 151 SNVI</td><td>16S 181</td></tr> <tr><td>16S 151IT DAF</td><td>16S 181 IVE</td></tr> <tr><td>16S 151PTO HIN</td><td>16S 181 MAN</td></tr> <tr><td>16S 1620TD</td><td>16S 181 RVI</td></tr> </table>	16S 151	16S 1621TD IT	16S 151 DAF	16S 1625TD	16S 151 HIN	16S 162TD IT	16S 151 HYU	16S 1630TD	16S 151 IVE	16S 1631TD IT	16S 151 KMZ	16S 1635TD	16S 151 MAN	16S 163TD IT	16S 151 RVI	16S 1685	16S 151 SNVI	16S 181	16S 151IT DAF	16S 181 IVE	16S 151PTO HIN	16S 181 MAN	16S 1620TD	16S 181 RVI
16S 151	16S 1621TD IT																									
16S 151 DAF	16S 1625TD																									
16S 151 HIN	16S 162TD IT																									
16S 151 HYU	16S 1630TD																									
16S 151 IVE	16S 1631TD IT																									
16S 151 KMZ	16S 1635TD																									
16S 151 MAN	16S 163TD IT																									
16S 151 RVI	16S 1685																									
16S 151 SNVI	16S 181																									
16S 151IT DAF	16S 181 IVE																									
16S 151PTO HIN	16S 181 MAN																									
16S 1620TD	16S 181 RVI																									
<p><b>T12301</b></p> 	<p><b>Description:</b> TIE ROD</p> <p><b>OEM No :</b> 1250 307 541</p> <p><b>EX / CROSS :</b></p>	<p><b>Packaging Unit:</b> 1</p> <p><b>Model:</b></p>																								
<p><b>T15648</b></p> 	<p><b>Description:</b> TIE ROD</p> <p><b>OEM No :</b> 1269 307 575</p> <p><b>EX / CROSS :</b></p>	<p><b>Packaging Unit:</b> 1</p> <p><b>Model:</b></p>																								
<p><b>T18581</b></p> 	<p><b>Description:</b> TIE ROD</p> <p><b>OEM No :</b> 1295 307 274</p> <p><b>EX / CROSS :</b></p>	<p><b>Packaging Unit:</b> 1</p> <p><b>Model:</b></p>																								
<p><b>T16580</b></p> 	<p><b>Description:</b> TIE ROD</p> <p><b>OEM No :</b> 1269 307 297</p> <p><b>EX / CROSS :</b></p>	<p><b>Packaging Unit:</b> 1</p> <p><b>Model:</b></p>																								







<p><b>T15861</b></p> 	<p><b>Description:</b> TIE ROD</p> <p><b>Packaging Unit:</b> 1</p> <p><b>OEM No :</b> 1250 207 172</p> <p><b>Model:</b></p> <p><b>EX / CROSS :</b></p>
<p><b>T19318</b></p> 	<p><b>Description:</b> TIE ROD</p> <p><b>Packaging Unit:</b> 1</p> <p><b>OEM No :</b> 1240 307 346</p> <p><b>Model:</b> AK6 65 AK6 65+GV80 AK6 80 AK6 80+GV80 S6 65 S6 65+GV80 S6 80 S6 80+GV80 S6 80/1 S6 80/1+GV80 S6 90 S6 90 SETRA</p> <p><b>EX / CROSS :</b> 1240 307 226 0091 307 303</p> <p>S6 90+GV90 S6 90+GV90 SNVI S6 90/1 S6 90/1+GV90</p>
<p><b>T50155</b></p> 	<p><b>Description:</b> VALVE</p> <p><b>Packaging Unit:</b> 1</p> <p><b>OEM No :</b> 0501 215 358</p> <p><b>Model:</b> 16S 151 16S 1685 16S 181 16S 1820TO 16S 1821TO IT 16S 182TO IT 16S 221 16S 2230TO 16S 2231TO IT 16S 2233TO 16S 2235TO 16S 223TO IT</p> <p><b>EX / CROSS :</b> 0501 207 444 0501 208 629 0501 209 434</p> <p>16S 2520TO 16S 2521TO IT 16S 2523TO 16S 2525TO 16S 2530TO 16S 2531TO IT 16S 2533TO 16S 2535TO 16S 253TO IT 16S 2731TO IT 16S 2733TO 16S 2735TO</p>
<p><b>T50156</b></p> 	<p><b>Description:</b> VALVE</p> <p><b>Packaging Unit:</b> 1</p> <p><b>OEM No :</b> 0501 215 359</p> <p><b>Model:</b> 12S 2130TD 12S 2131TD IT 12S 2133TD 12S 2330TD 12S 2331TD IT 12S 2333TD 12S 233TD IT 12S 2830TD 12S 2831TD IT 12S 2833TD 12S 283TD IT 16S 151</p> <p><b>EX / CROSS :</b> 0501 207 445 0501 208 630 0501 209 435 0501 219 310</p> <p>16S 1620TD 16S 1621TD IT 16S 1625TD 16S 162TD IT 16S 1630TD 16S 1631TD IT 16S 1635TD 16S 163TD IT 16S 181 16S 1830TO 16S 1831TO IT 16S 1833TO</p>
<p><b>T53418</b></p> 	<p><b>Description:</b> VALVE</p> <p><b>Packaging Unit:</b> 1</p> <p><b>OEM No :</b> 0750 132 032</p> <p><b>Model:</b> 16S 1650</p> <p><b>EX / CROSS :</b> 0501 203 684 0501 204 597 0501 396 632 1295 212 009</p>

<p><b>T57798</b></p> 	<p><b>Description:</b> VALVE</p> <p><b>OEM No :</b> 0501 211 290</p> <p><b>EX / CROSS :</b></p>	<p><b>Packaging Unit:</b> 1</p> <p><b>Model:</b></p>																								
<p><b>T70490</b></p> 	<p><b>Description:</b> VALVE</p> <p><b>OEM No :</b> 0501 321 459</p> <p><b>EX / CROSS :</b></p>	<p><b>Packaging Unit:</b> 1</p> <p><b>Model:</b></p> <table border="0"> <tr> <td>12AS 1631TD IT</td> <td>16AS 2231TD IT</td> </tr> <tr> <td>12AS 1931TD IT</td> <td>16AS 2601TO IT</td> </tr> <tr> <td>12AS 1931TO IT</td> <td>16AS 2631TO IT</td> </tr> <tr> <td>12AS 2131TD IT</td> <td>16S 1621TD IT</td> </tr> <tr> <td>12AS 2131TO IT</td> <td>16S 2321TD IT</td> </tr> <tr> <td>12AS 2301IT</td> <td>16S 2521TO IT</td> </tr> <tr> <td>12AS 2331TD IT</td> <td>8S 1621TD IT</td> </tr> <tr> <td>12AS 2331TO IT</td> <td>8S 1821TO IT</td> </tr> <tr> <td>12AS 2341TD IT</td> <td>9S 1111TD IT</td> </tr> <tr> <td>12AS 2531TO IT</td> <td>9S 1111TO IT</td> </tr> <tr> <td>12AS 2941TO IT</td> <td>9S 1311TO IT</td> </tr> <tr> <td>12AS 3001IT</td> <td>AS Tronic</td> </tr> </table>	12AS 1631TD IT	16AS 2231TD IT	12AS 1931TD IT	16AS 2601TO IT	12AS 1931TO IT	16AS 2631TO IT	12AS 2131TD IT	16S 1621TD IT	12AS 2131TO IT	16S 2321TD IT	12AS 2301IT	16S 2521TO IT	12AS 2331TD IT	8S 1621TD IT	12AS 2331TO IT	8S 1821TO IT	12AS 2341TD IT	9S 1111TD IT	12AS 2531TO IT	9S 1111TO IT	12AS 2941TO IT	9S 1311TO IT	12AS 3001IT	AS Tronic
12AS 1631TD IT	16AS 2231TD IT																									
12AS 1931TD IT	16AS 2601TO IT																									
12AS 1931TO IT	16AS 2631TO IT																									
12AS 2131TD IT	16S 1621TD IT																									
12AS 2131TO IT	16S 2321TD IT																									
12AS 2301IT	16S 2521TO IT																									
12AS 2331TD IT	8S 1621TD IT																									
12AS 2331TO IT	8S 1821TO IT																									
12AS 2341TD IT	9S 1111TD IT																									
12AS 2531TO IT	9S 1111TO IT																									
12AS 2941TO IT	9S 1311TO IT																									
12AS 3001IT	AS Tronic																									
<p><b>T45496</b></p> 	<p><b>Description:</b> VALVE</p> <p><b>OEM No :</b> 6038 202 003</p> <p><b>EX / CROSS :</b> 0501 204 063 0501 204 851 0750 132 001 0750 132 037</p>	<p><b>Packaging Unit:</b> 1</p> <p><b>Model:</b></p> <table border="0"> <tr> <td>16K 130</td> <td>16S 160A/1</td> </tr> <tr> <td>16K 160</td> <td>16S 1650 IVE</td> </tr> <tr> <td>16K 190</td> <td>16S 1650 MAZ</td> </tr> <tr> <td>16S 112</td> <td>16S 190</td> </tr> <tr> <td>16S 112/1</td> <td>16S 190/1</td> </tr> <tr> <td>16S 130</td> <td>16S 190A</td> </tr> <tr> <td>16S 130/1</td> <td>16S 190A/1</td> </tr> <tr> <td>16S 150</td> <td>16S 220</td> </tr> <tr> <td>16S 151</td> <td>16S 220A</td> </tr> <tr> <td>16S 160</td> <td>16S 221</td> </tr> <tr> <td>16S 160/1</td> <td>8S 1350 KMZ</td> </tr> <tr> <td>16S 160A</td> <td>Ecosplit III</td> </tr> </table>	16K 130	16S 160A/1	16K 160	16S 1650 IVE	16K 190	16S 1650 MAZ	16S 112	16S 190	16S 112/1	16S 190/1	16S 130	16S 190A	16S 130/1	16S 190A/1	16S 150	16S 220	16S 151	16S 220A	16S 160	16S 221	16S 160/1	8S 1350 KMZ	16S 160A	Ecosplit III
16K 130	16S 160A/1																									
16K 160	16S 1650 IVE																									
16K 190	16S 1650 MAZ																									
16S 112	16S 190																									
16S 112/1	16S 190/1																									
16S 130	16S 190A																									
16S 130/1	16S 190A/1																									
16S 150	16S 220																									
16S 151	16S 220A																									
16S 160	16S 221																									
16S 160/1	8S 1350 KMZ																									
16S 160A	Ecosplit III																									
<p><b>T66265</b></p> 	<p><b>Description:</b> VALVE + 2 BALL ROLLER INCLUDED</p> <p><b>OEM No :</b> 6038 202 043</p> <p><b>EX / CROSS :</b> 6038 202 035 6038 202 045</p>	<p><b>Packaging Unit:</b> 1</p> <p><b>Model:</b></p> <table border="0"> <tr> <td>16S 151</td> </tr> <tr> <td>16S 1685</td> </tr> <tr> <td>16S 181</td> </tr> <tr> <td>16S 221</td> </tr> <tr> <td>16S 2280TO</td> </tr> <tr> <td>16S 251</td> </tr> <tr> <td>Ecosplit III</td> </tr> </table>	16S 151	16S 1685	16S 181	16S 221	16S 2280TO	16S 251	Ecosplit III																	
16S 151																										
16S 1685																										
16S 181																										
16S 221																										
16S 2280TO																										
16S 251																										
Ecosplit III																										
<p><b>T08937</b></p> 	<p><b>Description:</b> WASHER</p> <p><b>OEM No :</b> 0730 150 767</p> <p><b>EX / CROSS :</b> 0501 304 692</p>	<p><b>Packaging Unit:</b> 10</p> <p><b>Model:</b></p>																								



<p><b>T52341</b></p> 	<p><b>Description:</b> WASHER</p> <p><b>OEM No :</b> 0750 101 158</p> <p><b>EX / CROSS :</b></p> <p><b>Model:</b> 12S 2130TD 12S 2131TD IT 12S 2133TD 12S 2330TD 12S 2331TD IT 12S 2333TD 12S 2333TD IT 12S 2830TD 12S 2831TD IT 12S 2833TD 12S 2833TD IT 16S 151</p>	<p><b>Packaging Unit:</b> 2</p> <p>16S 1620TD 16S 1621TD IT 16S 1625TD 16S 162TD IT 16S 1630TD 16S 1631TD IT 16S 1635TD 16S 163TD IT 16S 1685 16S 181 16S 182 16S 1820TO</p>
<p><b>T53911</b></p> 	<p><b>Description:</b> WASHER</p> <p><b>OEM No :</b> 0730 106 561</p> <p><b>EX / CROSS :</b></p> <p><b>Model:</b> 5S 580 5S 600BO S5 42 S5 420 S5 47</p>	<p><b>Packaging Unit:</b> 1</p>
<p><b>T23281</b></p> 	<p><b>Description:</b> WASHER (T.1,00)</p> <p><b>OEM No :</b> 0730 000 286</p> <p><b>EX / CROSS :</b></p> <p><b>Model:</b> 12AS 1210TO 12AS 1220TD 12AS 1420TD 12AS 1420TO 12AS 1620TO 9S 1315TO AS Tronic</p>	<p><b>Packaging Unit:</b> 1</p>
<p><b>T39097</b></p> 	<p><b>Description:</b> WASHER (T.1,85)</p> <p><b>OEM No :</b> 0730 106 905</p> <p><b>EX / CROSS :</b></p> <p><b>Model:</b> 12S 2130TD 12S 2131TD IT 12S 2133TD 12S 2330TD 12S 2331TD IT 12S 2333TD 12S 2333TD IT 12S 2830TD 12S 2831TD IT 12S 2833TD 12S 283TD IT 16S 151 DAF</p>	<p><b>Packaging Unit:</b> 1</p> <p>16S 151 HIN 16S 151 HYU 16S 151 IVE 16S 151 KMZ 16S 151 MAN 16S 151 SNVI 16S 151IT DAF 16S 151PTO HIN 16S 1620TD 16S 1621TD IT 16S 1625TD 16S 162TD IT</p>
<p><b>T23305</b></p> 	<p><b>Description:</b> WASHER (T.2,00)</p> <p><b>OEM No :</b> 0730 105 493</p> <p><b>EX / CROSS :</b> 0630 003 009 0630 305 502 6001 302 082</p> <p><b>Model:</b> 16S 151PTO HIN 9S 1115TO 9S 1315TO</p>	<p><b>Packaging Unit:</b> 1</p>



<p><b>T39094</b></p> 	<p><b>Description:</b> WASHER (T.2,20)</p> <p><b>OEM No :</b> 0730 101 467</p> <p><b>EX / CROSS :</b></p>	<p><b>Packaging Unit:</b> 1</p> <p><b>Model:</b> 12S 2130TD 12S 2131TD IT 12S 2133TD 12S 2330TD 12S 2331TD IT 12S 2333TD 12S 2333TD IT 12S 2830TD 12S 2831TD IT 12S 2833TD 12S 283TD IT 16S 151 DAF 16S 151 HIN 16S 151 HYU 16S 151 IVE 16S 151 KMZ 16S 151 MAN 16S 151 SNVI 16S 151IT DAF 16S 151PTO HIN 16S 1620TD 16S 1621TD IT 16S 1625TD 16S 162TD IT</p>
<p><b>T39095</b></p> 	<p><b>Description:</b> WASHER (T.2,65)</p> <p><b>OEM No :</b> 0730 106 910</p> <p><b>EX / CROSS :</b></p>	<p><b>Packaging Unit:</b> 1</p> <p><b>Model:</b> 12S 2130TD 12S 2131TD IT 12S 2133TD 12S 2330TD 12S 2331TD IT 12S 2333TD 12S 2333TD IT 12S 2830TD 12S 2831TD IT 12S 2833TD 12S 283TD IT 16S 151 DAF 16S 151 HIN 16S 151 HYU 16S 151 IVE 16S 151 KMZ 16S 151 MAN 16S 151 SNVI 16S 151IT DAF 16S 151PTO HIN 16S 1620TD 16S 1621TD IT 16S 1625TD 16S 162TD IT</p>
<p><b>T39096</b></p> 	<p><b>Description:</b> WASHER (T.3,00)</p> <p><b>OEM No :</b> 0730 106 917</p> <p><b>EX / CROSS :</b></p>	<p><b>Packaging Unit:</b> 1</p> <p><b>Model:</b> 12S 2130TD 12S 2131TD IT 12S 2133TD 12S 2330TD 12S 2331TD IT 12S 2333TD 12S 2333TD IT 12S 2830TD 12S 2831TD IT 12S 2833TD 12S 283TD IT 16S 151 16S 151 DAF 16S 151 HIN 16S 151 HYU 16S 151 IVE 16S 151 KMZ 16S 151 MAN 16S 151 SNVI 16S 151IT DAF 16S 151PTO HIN 16S 1620TD 16S 1621TD IT 16S 1625TD</p>
<p><b>T41517</b></p> 	<p><b>Description:</b> ZF AS-TRONIC GS3 GEARBOX SHIFT MODULATOR / ACTUATOR</p> <p><b>OEM No :</b> TAS41517</p> <p><b>EX / CROSS :</b></p>	<p><b>Packaging Unit:</b> 1</p> <p><b>Model:</b></p>



OEM no.	TAS no. Pag.	OEM no.	TAS no. Pag.	OEM no.	TAS no. Pag.
(000 260 1597/G)	T10134 185	0091 304 202	T54731 229	0501 212 367	T60646 86
0000 104 578	T09038 89	0091 304 204	T56727 250	0501 212 474	T41595 61
0090 298 189	T54497 116	0091 304 207	T53403 230	0501 214 821	T60646 86
0090 298 191	T20194 115	0091 304 208	T52771 138	0501 214 822	T57536 86
0091 202 028	T50153 135	0091 304 210	T44698 194	0501 215 062	T75906 163
0091 202 057	T09751 161	0091 304 219	T46590 62	0501 215 163	T62175 160
0091 232 013	T19961 179	0091 304 266	T52771 138	0501 215 245	T58905 161
0091 232 022	T19961 179	0091 304 297	T44693 12	0501 215 358	T50155 300
0091 298 001	T38270 112	0091 304 298	T58563 45	0501 215 359	T50156 300
0091 298 010	T20194 115	0091 304 310	T20895 242	0501 217 295	T73206 212
0091 302 097	T58555 126	0091 304 311	T20899 242	0501 219 105	T79150 86
0091 302 152	T63688 230	0091 304 314	T39343 34	0501 219 310	T50156 300
0091 302 160	T46559 62	0091 304 315	T46590 62	0501 219 311	T73206 212
0091 302 173	T50153 135	0091 304 317	T53398 18	0501 304 692	T08937 301
0091 302 176	T18339 77	0091 304 322	T53401 17	0501 305 887	T08940 295
0091 302 179	T46563 64	0091 304 341	T08460 196	0501 306 212	T15745 297
0091 302 208	T45797 231	0091 304 361	T17886 258	0501 306 439	T21769 165
0091 302 272	T46563 64	0091 304 367	T44698 194	0501 307 769	T21786 164
0091 302 276	T53391 67	0091 304 369	T41820 24	0501 309 420	T21769 165
0091 302 294	T39344 67	0091 304 372	T53401 17	0501 309 421	T21769 165
0091 303 030	T56685 47	0091 305 012	T09810 56	0501 310 614	T21583 110
0091 303 093	T44688 26	0091 307 303	T19318 300	0501 311 036	T39312 163
0091 303 094	T44682 38	0091 307 500	T18869 79	0501 312 712	T20859 166
0091 303 102	T46577 35	0095 353 232	T18571 84	0501 312 738	T21945 166
0091 303 104	T46568 77	0501 203 684	T53418 300	0501 312 845	T20859 166
0091 303 106	T46573 19	0501 203 819	T50733 54	0501 313 513	T21879 100
0091 303 136	T54714 73	0501 204 063	T45496 301	0501 314 060	T18524 163
0091 303 137	T44688 26	0501 204 318	T45524 54	0501 314 108	T20699 171
0091 303 138	T44682 38	0501 204 597	T53418 300	0501 314 246	T21814 110
0091 303 141	T46577 35	0501 204 714	T50733 54	0501 314 587	T21819 103
0091 303 142	T44682 38	0501 204 851	T45496 301	0501 314 747	T21891 104
0091 303 143	T46577 35	0501 206 799	T50736 54	0501 314 772	T39312 163
0091 303 146	T46568 77	0501 206 800	T50741 54	0501 314 808	T21827 103
0091 303 147	T53404 65	0501 207 444	T50155 300	0501 315 085	T21429 221
0091 303 171	T15033 46	0501 207 445	T50156 300	0501 315 106	T38731 100
0091 303 172	T15040 46	0501 208 629	T50155 300	0501 315 917	T09038 89
0091 303 173	T15033 46	0501 208 630	T50156 300	0501 316 146	T21827 103
0091 303 174	T15040 46	0501 209 188	T39674 54	0501 316 270	T85251 60
0091 304 054	T60287 34	0501 209 212	T72906 55	0501 316 322	T37666 98
0091 304 062	T54726 231	0501 209 434	T50155 300	0501 316 778	T39312 163
0091 304 094	T60287 34	0501 209 435	T50156 300	0501 317 240	T21838 110
0091 304 109	T20899 242	0501 209 448	T22268 95	0501 317 289	T60654 101
0091 304 128	T50154 228	0501 210 058	T53457 227	0501 317 536	T21955 157
0091 304 190	T44693 12	0501 211 290	T57798 301	0501 318 308	T21843 111
0091 304 191	T53401 17	0501 211 400	T22268 95	0501 319 864	T57557 115
0091 304 192	T53398 18	0501 211 493	T57536 86	0501 320 435	T18524 163
0091 304 193	T39343 34	0501 211 617	T60646 86	0501 321 065	T21000 102
0091 304 194	T46586 226	0501 211 618	T57536 86	0501 321 146	T41470 188





OEM no.	TAS no. Pag.	OEM no.	TAS no. Pag.	OEM no.	TAS no. Pag.
0501 321 148	T67389 209	0630 501 112	T39098 206	0634 314 017	T21618 158
0501 321 442	T57325 99	0630 501 116	T39099 206	0634 314 018	T21628 158
0501 321 443	T57516 98	0630 501 142	T58473 209	0634 314 019	T21636 160
0501 321 451	T57315 99	0630 501 147	T53644 207	0634 314 020	T21645 160
0501 321 459	T70490 301	0630 501 175	T39112 205	0634 314 021	T21107 158
0501 321 879	T80245 98	0630 501 312	T66444 206	0634 314 022	T21657 159
0501 322 825	T75057 98	0630 501 313	T39101 208	0634 316 057	T21107 158
0501 322 828	T21001 101	0630 501 316	T39100 208	0634 316 174	T21645 160
0501 322 829	T21002 101	0630 501 334	T39102 208	0634 316 523	T37680 157
0501 323 922	T57557 115	0630 501 339	T73071 190	0634 349 645	T80286 169
0501 324 072	T21838 110	0630 501 516	T39100 208	0634 801 013	T21662 200
0501 324 254	T94436 81	0630 502 027	T18530 205	0634 801 027	T21705 201
0501 324 292	T20859 166	0630 502 063	T20703 205	0634 801 028	T21667 201
0501 324 367	T57325 99	0630 502 218	T66446 206	0634 801 038	T21718 201
0501 324 368	T57516 98	0630 531 055	T19907 207	0634 801 045	T21668 202
0501 324 599	T61369 208	0630 531 064	T39113 206	0634 801 050	T21668 202
0501 324 626	T21003 100	0630 531 070	T61369 208	0634 801 051	T22026 202
0501 324 670	T58490 176	0631 329 016	T09037 88	0634 801 062	T21677 202
0501 325 624	T65053 103	0631 329 017	T15771 88	0634 801 073	T22053 203
0501 325 930	T18524 163	0631 329 018	T37830 88	0634 801 074	T21685 202
0501 327 837	T78743 103	0631 329 048	T09038 89	0634 801 097	T22012 204
0501 329 501	T78994 111	0631 329 050	T15775 89	0634 801 156	T21722 203
0501 331 264	T78748 111	0631 329 051	T37822 89	0634 801 164	T21693 201
0501 331 587	T65053 103	0631 329 052	T37822 89	0634 801 205	T21693 201
0501 331 660	T53457 227	0631 329 147	T43978 89	0634 801 206	T22020 203
0501 331 906	T56532 99	0631 329 167	T37830 88	0634 801 214	T21693 201
0501 396 632	T53418 300	0631 329 261	T43979 88	0634 801 216	T21667 201
0501 398 018	T21067 164	0634 300 020	T21588 165	0634 801 217	T22271 202
0501 398 042	T21769 165	0634 300 128	T37877 170	0634 801 219	T22026 202
0501 398 216	T54650 82	0634 300 185	T21067 164	0634 801 236	T21735 203
0501 398 244	T54646 82	0634 300 302	T21080 165	0634 801 246	T21705 201
0501 398 245	T54650 82	0634 300 543	T39290 167	0634 801 249	T22033 203
0501 398 348	T38154 82	0634 300 712	T21138 172	0634 801 250	T21715 204
0501 398 349	T38154 82	0634 304 327	T21618 158	0634 801 260	T21718 201
0501 398 351	T46769 154	0634 307 367	T21095 166	0634 801 308	T37686 200
0501 398 371	T15366 120	0634 307 825	T21798 169	0634 801 321	T22036 204
0501 398 752	T39110 90	0634 312 523	T21967 165	0634 801 324	T21722 203
0501 398 753	T15289 189	0634 313 018	T21971 159	0635 303 019	T72948 145
0630 003 009	T23305 302	0634 313 052	T21606 159	0635 304 904	T22220 53
0630 305 502	T23305 302	0634 313 053	T21657 159	0635 330 016	T47553 53
0630 331 070	T61369 208	0634 313 198	T21981 158	0635 330 050	T47553 53
0630 501 019	T50679 205	0634 313 320	T21994 159	0635 331 390	T19914 52
0630 501 024	T09503 205	0634 313 375	T21955 157	0635 338 035	T56940 51
0630 501 031	T09545 207	0634 313 505	T22001 158	0635 338 048	T47385 53
0630 501 033	T09547 207	0634 313 671	T21597 159	0635 370 030	T47570 287
0630 501 050	T58110 207	0634 313 734	T21636 160	0635 373 004	T23272 290
0630 501 061	T39111 209	0634 313 805	T22007 160	0635 373 008	T47396 293
0630 501 073	T63639 208	0634 314 015	T21606 159	0635 373 021	T23272 290



OEM no.	TAS no. Pag.	OEM no.	TAS no. Pag.	OEM no.	TAS no. Pag.
0635 374 019	T37785 290	0730 109 323	T53081 296	0734 310 108	T21126 167
0635 375 007	T56247 294	0730 110 392	T64456 297	0734 310 109	T21159 171
0635 376 023	T22670 289	0730 150 064	T14283 296	0734 310 110	T21759 168
0635 460 010	T09039 51	0730 150 767	T08937 301	0734 310 111	T20838 170
0635 470 012	T50157 199	0730 160 240	T09810 56	0734 310 112	T38660 166
0635 470 046	T37749 186	0730 160 344	T09810 56	0734 310 116	T20768 164
0635 501 357	T22217 292	0730 161 354	T37620 60	0734 310 122	T50627 171
0635 501 400	T22217 292	0730 161 689	T45553 57	0734 310 142	T37877 170
0635 900 363	T38138 292	0730 162 428	T45553 57	0734 310 161	T38576 167
0635 900 686	T47385 53	0730 162 753	T20838 170	0734 310 230	T75437 170
0636 604 496	T23296 199	0730 162 804	T57481 157	0734 310 253	T37750 166
0730 000 286	T23281 302	0730 260 330	T16568 58	0734 310 304	T38660 166
0730 004 796	T50158 220	0730 301 356	T15289 189	0734 310 386	T20838 170
0730 005 465	T39109 220	0730 302 523	T57438 136	0734 310 387	T20838 170
0730 005 748	T39089 219	0730 361 046	T09499 188	0734 310 396	T37750 166
0730 005 749	T39090 219	0730 501 360	T58316 209	0734 310 397	T38688 167
0730 006 171	T39108 90	0730 501 598	T58473 209	0734 310 435	T56534 170
0730 007 136	T39093 219	0730 513 641	T60587 190	0734 317 025	T21798 169
0730 007 484	T39092 219	0730 513 682	T57438 136	0734 317 032	T21748 157
0730 007 489	T39091 220	0730 513 862	T63639 208	0734 317 150	T21748 157
0730 007 747	T39110 90	0731 208 033	T19116 176	0734 319 047	T37763 171
0730 008 055	T22042 200	0731 208 242	T57538 175	0734 319 221	T54606 168
0730 008 057	T22049 201	0732 040 385	T08950 225	0734 319 253	T20768 164
0730 008 604	T22026 202	0732 040 386	T08951 225	0734 319 283	T37860 172
0730 008 637	T21735 203	0732 040 409	T13440 223	0734 319 439	T37860 172
0730 009 515	T22053 203	0732 040 497	T08953 224	0734 319 440	T38575 171
0730 061 190	T09499 188	0732 040 735	T08941 223	0734 319 459	T20762 164
0730 061 816	T15289 189	0732 040 736	T09068 223	0734 319 514	T38862 169
0730 061 842	T53677 174	0732 040 929	T08941 223	0734 319 559	T37877 170
0730 061 890	T08926 189	0732 041 571	T09556 224	0734 319 609	T54606 168
0730 061 921	T09497 189	0732 042 510	T11828 224	0734 319 652	T37898 168
0730 062 579	T19311 189	0732 042 766	T57544 224	0734 319 687	T38575 171
0730 062 781	T39036 189	0732 107 001	T50733 54	0734 319 782	T69066 167
0730 063 154	T75033 190	0732 107 010	T50741 54	0734 319 847	T37694 169
0730 101 467	T39094 303	0732 107 018	T50741 54	0735 295 119	T37620 60
0730 101 784	T15920 296	0732 107 019	T50736 54	0735 295 223	T78294 60
0730 102 412	T38854 296	0734 300 087	T39290 167	0735 298 169	T50164 145
0730 102 988	T15921 297	0734 300 093	T21138 172	0735 300 149	T46785 149
0730 103 102	T08938 217	0734 300 094	T54637 170	0735 300 150	T46794 151
0730 103 846	T08939 218	0734 300 095	T20768 164	0735 300 495	T49029 294
0730 105 156	T19347 221	0734 300 102	T20768 164	0735 300 509	T22670 289
0730 105 493	T23305 302	0734 300 196	T21080 165	0735 300 512	T22217 292
0730 106 561	T53911 302	0734 300 421	T57520 164	0735 300 513	T57809 291
0730 106 905	T39097 302	0734 300 679	T57520 164	0735 301 274	T57353 145
0730 106 910	T39095 303	0734 307 280	T20829 163	0735 301 601	T61822 294
0730 106 917	T39096 303	0734 307 287	T38681 168	0735 301 881	T57377 145
0730 107 168	T38854 296	0734 307 294	T20829 163	0735 302 221	T50169 148
0730 109 309	T53087 296	0734 310 104	T21004 168	0735 320 042	T46897 146



OEM no.	TAS no. Pag.	OEM no.	TAS no. Pag.	OEM no.	TAS no. Pag.
0735 320 110	T46911 151	0735 321 094	T56143 154	0735 371 599	T22222 291
0735 320 111	T46924 155	0735 321 169	T77648 150	0735 371 604	T22219 291
0735 320 154	T46878 153	0735 321 373	T61001 155	0735 371 605	T23878 291
0735 320 161	T46801 148	0735 321 381	T57377 145	0735 371 607	T22338 289
0735 320 203	T46888 147	0735 321 437	T61001 155	0735 371 748	T22221 288
0735 320 205	T46801 148	0735 321 487	T57353 145	0735 371 749	T22670 289
0735 320 206	T46931 152	0735 321 530	T51474 151	0735 371 994	T54551 290
0735 320 261	T46856 148	0735 321 563	T50169 148	0735 372 156	T22219 291
0735 320 314	T46888 147	0735 321 580	T78305 147	0735 372 213	T56247 294
0735 320 371	T46847 152	0735 321 581	T78313 150	0735 410 051	T23890 84
0735 320 374	T46834 151	0735 321 582	T78320 152	0735 410 238	T23890 84
0735 320 377	T46816 150	0735 321 588	T78305 147	0735 410 319	T22335 83
0735 320 396	T46856 148	0735 321 589	T78313 150	0735 410 327	T22335 83
0735 320 407	T46911 151	0735 321 590	T78320 152	0735 455 004	T47477 82
0735 320 408	T46924 155	0735 330 043	T22220 53	0735 455 018	T38025 81
0735 320 410	T46931 152	0735 330 614	T55355 52	0735 455 019	T47477 82
0735 320 451	T46704 153	0735 330 615	T22337 52	0735 455 023	T38025 81
0735 320 452	T46712 153	0735 330 685	T55355 52	0735 455 040	T38014 82
0735 320 460	T46664 152	0735 330 800	T55355 52	0735 455 062	T38006 83
0735 320 462	T46834 151	0735 330 801	T54549 52	0735 455 101	T38006 83
0735 320 465	T46785 149	0735 340 080	T47446 53	0735 455 114	T38006 83
0735 320 466	T46794 151	0735 358 128	T63588 146	0735 455 248	T37993 83
0735 320 471	T46931 152	0735 358 156	T63588 146	0735 470 007	T53730 176
0735 320 475	T46683 153	0735 358 192	T51495 146	0735 470 027	T08935 156
0735 320 483	T46847 152	0735 358 313	T50168 84	0735 470 057	T08936 156
0735 320 484	T46847 152	0735 358 333	T56554 146	0735 470 074	T15760 156
0735 320 486	T46721 151	0735 358 340	T56554 146	0735 470 163	T15760 156
0735 320 487	T46731 153	0735 358 346	T56554 146	0735 501 011	T22207 292
0735 320 492	T46897 146	0735 370 058	T22207 292	0737 006 005	T23323 157
0735 320 496	T46759 150	0735 370 059	T22218 292	0737 006 061	T23323 157
0735 320 499	T46801 148	0735 370 216	T61822 294	0737 300 035	T23323 157
0735 320 500	T51474 151	0735 370 233	T22659 294	0737 502 092	T15366 120
0735 320 548	T46670 149	0735 370 282	T23272 290	0750 101 158	T52341 302
0735 320 549	T46676 152	0735 370 297	T22215 294	0750 101 179	T18524 163
0735 320 551	T46834 151	0735 370 298	T56247 294	0750 110 074	T21138 172
0735 320 584	T46769 154	0735 370 438	T22587 289	0750 111 002	T21759 168
0735 320 684	T46683 153	0735 370 470	T22222 291	0750 111 004	T21159 171
0735 320 786	T46769 154	0735 370 513	T56936 288	0750 111 040	T37877 170
0735 320 799	T46683 153	0735 370 987	T37644 288	0750 111 081	T37860 172
0735 320 816	T50165 150	0735 371 096	T22212 289	0750 111 149	T38576 167
0735 320 837	T54656 149	0735 371 232	T22216 290	0750 111 159	T54606 168
0735 320 871	T53922 148	0735 371 268	T37914 291	0750 111 268	T37763 171
0735 320 873	T53929 149	0735 371 372	T56936 288	0750 111 269	T38660 166
0735 320 896	T46739 154	0735 371 375	T37644 288	0750 111 317	T37860 172
0735 320 941	T59143 145	0735 371 406	T23803 288	0750 111 334	T38575 171
0735 321 010	T53937 146	0735 371 464	T47570 287	0750 111 341	T20768 164
0735 321 013	T64098 149	0735 371 563	T22216 290	0750 111 348	T37694 169
0735 321 087	T49178 154	0735 371 591	T37644 288	0750 111 424	T54606 168



OEM no.	TAS no. Pag.	OEM no.	TAS no. Pag.	OEM no.	TAS no. Pag.
0750 111 469	T37763 171	0750 115 959	T46739 154	0750 117 844	T22222 291
0750 111 476	T38660 166	0750 115 969	T50169 148	0750 117 881	T22212 289
0750 111 575	T21945 166	0750 115 970	T46834 151	0750 117 883	T22207 292
0750 112 019	T21748 157	0750 115 971	T50165 150	0750 117 892	T59348 293
0750 112 034	T21769 165	0750 115 973	T51522 148	0750 118 005	T38006 83
0750 112 047	T21011 165	0750 115 974	T51495 146	0750 118 008	T38014 82
0750 112 066	T21786 164	0750 116 002	T22220 53	0750 118 010	T38025 81
0750 112 089	T21798 169	0750 116 166	T47385 53	0750 118 019	T47477 82
0750 112 096	T52347 197	0750 116 197	T66036 53	0750 118 030	T37993 83
0750 112 117	T22059 169	0750 116 231	T38058 52	0750 118 038	T38014 82
0750 112 131	T20859 166	0750 116 233	T19914 52	0750 118 077	T38034 83
0750 112 136	T21922 104	0750 116 373	T22337 52	0750 118 082	T38034 83
0750 112 138	T21814 110	0750 116 374	T55355 52	0750 118 131	T23890 84
0750 112 153	T21814 110	0750 116 394	T22220 53	0750 118 153	T38154 82
0750 112 177	T22059 169	0750 116 404	T66036 53	0750 118 191	T38047 83
0750 112 239	T39312 163	0750 117 008	T37803 293	0750 118 198	T22335 83
0750 112 253	T20859 166	0750 117 009	T22219 291	0750 118 220	T37993 83
0750 115 007	T46801 148	0750 117 010	T22207 292	0750 118 258	T38047 83
0750 115 009	T51474 151	0750 117 011	T22218 292	0750 118 284	T57460 55
0750 115 011	T46897 146	0750 117 030	T22207 292	0750 119 109	T15760 156
0750 115 012	T51474 151	0750 117 057	T38138 292	0750 119 116	T15760 156
0750 115 021	T46712 153	0750 117 079	T22659 294	0750 119 124	T20963 57
0750 115 135	T63588 146	0750 117 080	T22221 288	0750 119 125	T20968 57
0750 115 225	T51522 148	0750 117 081	T23878 291	0750 119 143	T15760 156
0750 115 229	T51495 146	0750 117 083	T22217 292	0750 120 098	T23286 289
0750 115 233	T59143 145	0750 117 110	T22338 289	0750 120 334	T61822 294
0750 115 282	T46924 155	0750 117 198	T22587 289	0750 132 001	T45496 301
0750 115 283	T46931 152	0750 117 199	T22338 289	0750 132 019	T50387 81
0750 115 299	T50166 147	0750 117 210	T59348 293	0750 132 027	T18748 210
0750 115 303	T56143 154	0750 117 232	T22216 290	0750 132 032	T53418 300
0750 115 310	T61001 155	0750 117 251	T56936 288	0750 132 037	T45496 301
0750 115 325	T49199 155	0750 117 312	T57809 291	0750 190 014	T39312 163
0750 115 326	T56157 154	0750 117 332	T56247 294	0768 800 001	T57520 164
0750 115 327	T56150 155	0750 117 402	T22208 295	0768 800 253	T20838 170
0750 115 335	T45524 54	0750 117 403	T38142 295	0768 800 301	T56534 170
0750 115 366	T49209 147	0750 117 418	T64195 293	0769 171 145	T57493 180
0750 115 369	T50167 147	0750 117 507	T22221 288	0769 171 850	T77141 253
0750 115 427	T64098 149	0750 117 518	T22215 294	0769 174 312	T57520 164
0750 115 430	T77648 150	0750 117 524	T37785 290	0769 186 213	T53401 17
0750 115 531	T50168 84	0750 117 529	T56247 294	0769 186 281	T17870 283
0750 115 534	T50168 84	0750 117 562	T37644 288	0769 186 286	T09062 285
0750 115 565	T78305 147	0750 117 640	T23885 293	1203 307 289	T21297 106
0750 115 566	T78313 150	0750 117 651	T64195 293	1203 321 009	T09501 224
0750 115 567	T78320 152	0750 117 677	T38142 295	1205 308 016	T15531 218
0750 115 584	T49178 154	0750 117 678	T22208 295	1205 308 020	T15532 218
0750 115 956	T46731 153	0750 117 732	T22214 295	1205 308 038	T61323 218
0750 115 957	T46721 151	0750 117 778	T37785 290	1238 302 188	T10923 123
0750 115 958	T46712 153	0750 117 799	T61822 294	1238 304 007	T18726 140



OEM no.	TAS no. Pag.	OEM no.	TAS no. Pag.	OEM no.	TAS no. Pag.
1238 304 345	T18726 140	1249 304 222	T13455 187	1250 304 141	T08578 278
1238 304 357	T38931 281	1250 203 002	T08440 74	1250 304 142	T08952 55
1238 304 363	T10171 234	1250 204 072	T08451 239	1250 304 160	T08946 286
1238 304 383	T10171 234	1250 207 172	T15861 300	1250 304 165	T08451 239
1238 304 389	T37714 271	1250 302 196	T08339 122	1250 304 166	T08883 257
1238 304 390	T38931 281	1250 302 199	T08573 123	1250 304 167	T08866 282
1238 304 394	T13452 212	1250 302 202	T08479 238	1250 304 169	T08483 256
1238 304 420	T37714 271	1250 302 242	T08479 238	1250 304 170	T08947 272
1238 308 031	T57518 79	1250 302 258	T20305 122	1250 304 171	T08577 42
1238 308 032	T21176 97	1250 302 260	T15202 125	1250 304 178	T08576 31
1238 308 165	T57518 79	1250 302 263	T15565 80	1250 304 179	T08575 20
1238 308 166	T21176 97	1250 302 298	T21194 104	1250 304 181	T08470 42
1238 308 201	T21176 97	1250 302 301	T21421 108	1250 304 185	T08580 253
1238 309 163	T21176 97	1250 302 373	T21194 104	1250 304 203	T08947 272
1238 317 058	T20293 213	1250 302 478	T21194 104	1250 304 210	T08586 42
1240 304 205	T08843 281	1250 302 485	T21421 108	1250 304 211	T08866 282
1240 304 206	T08868 271	1250 303 021	T08517 50	1250 304 215	T08947 272
1240 304 212	T09240 282	1250 303 022	T08519 50	1250 304 217	T08585 31
1240 304 238	T09240 282	1250 303 027	T08560 48	1250 304 226	T08947 272
1240 304 265	T08868 271	1250 303 032	T08440 74	1250 304 228	T08559 239
1240 304 272	T08843 281	1250 303 038	T08340 30	1250 304 229	T08483 256
1240 304 278	T08949 186	1250 303 054	T08519 50	1250 304 233	T08459 279
1240 304 291	T08868 271	1250 303 055	T08517 50	1250 304 234	T08581 253
1240 304 305	T08868 271	1250 303 058	T08560 48	1250 304 236	T08461 280
1240 304 375	T09240 282	1250 303 062	T08340 30	1250 304 240	T08558 12
1240 305 005	T08506 179	1250 303 073	T08588 47	1250 304 292	T08559 239
1240 306 114	T16962 199	1250 303 074	T08588 47	1250 304 293	T08866 282
1240 306 167	T09064 199	1250 303 075	T08340 30	1250 304 305	T15438 45
1240 306 171	T08927 216	1250 303 084	T15446 30	1250 304 306	T08579 279
1240 306 234	T08927 216	1250 303 094	T15452 48	1250 304 312	T08451 239
1240 306 242	T09064 199	1250 303 099	T08440 74	1250 304 315	T08947 272
1240 306 244	T16962 199	1250 303 111	T08517 50	1250 304 350	T08449 244
1240 307 226	T19318 300	1250 303 112	T08519 50	1250 304 351	T08451 239
1240 307 338	T15890 136	1250 303 137	T15481 48	1250 304 352	T08559 239
1240 307 346	T19318 300	1250 304 004	T08571 280	1250 304 362	T08486 278
1240 312 073	T08843 281	1250 304 006	T08572 94	1250 304 384	T08470 42
1240 317 002	T08917 217	1250 304 008	T08575 20	1250 304 388	T08277 142
1240 317 005	T08917 217	1250 304 028	T08558 12	1250 304 389	T08479 238
1240 317 075	T08917 217	1250 304 029	T08570 14	1250 304 391	T08860 275
1240 317 141	T08917 217	1250 304 050	T08578 278	1250 304 396	T08883 257
1246 302 054	T15198 125	1250 304 052	T08585 31	1250 304 400	T15484 44
1246 302 073	T15198 125	1250 304 054	T08580 253	1250 304 417	T08868 271
1246 304 134	T11765 256	1250 304 070	T08576 31	1250 304 440	T16799 217
1246 304 135	T08483 256	1250 304 101	T08449 244	1250 304 441	T20038 279
1246 304 136	T15393 253	1250 304 124	T15397 248	1250 304 472	T08860 275
1246 304 278	T08874 274	1250 304 127	T08577 42	1250 304 474	T08487 144
1246 304 295	T08946 286	1250 304 129	T08574 144	1250 304 484	T08486 278
1249 304 215	T13455 187	1250 304 137	T08470 42	1250 304 485	T08459 279



OEM no.	TAS no. Pag.	OEM no.	TAS no. Pag.	OEM no.	TAS no. Pag.
1250 304 501	T08570 14	1268 204 006	T08896 13	1268 304 015	T08456 44
1250 304 503	T08558 12	1268 204 018	T08896 13	1268 304 094	T11387 43
1250 304 535	T08860 275	1268 298 889	T54497 116	1268 304 136	T08847 92
1250 305 003	T08582 179	1268 298 903	T20221 173	1268 304 141	T09045 56
1250 305 004	T08524 192	1268 298 904	T20408 115	1268 304 142	T14451 237
1250 305 007	T08524 192	1268 298 950	T46876 156	1268 304 143	T09047 248
1250 305 033	T08524 192	1268 302 001	T08464 124	1268 304 148	T14810 92
1250 306 148	T08930 214	1268 302 007	T09761 122	1268 304 150	T08885 259
1250 306 182	T21217 105	1268 302 015	T18443 122	1268 304 159	T08896 13
1250 306 282	T21217 105	1268 302 042	T08462 126	1268 304 204	T08481 17
1250 307 373	T15875 95	1268 302 047	T09761 122	1268 304 213	T08896 13
1250 307 521	T21239 105	1268 302 049	T18457 124	1268 304 227	T08494 12
1250 307 541	T12301 299	1268 302 095	T15444 121	1268 304 237	T19232 32
1250 307 572	T16559 136	1268 302 104	T08997 124	1268 304 250	T09050 45
1250 307 680	T21235 105	1268 302 126	T16608 124	1268 304 251	T09046 34
1250 307 686	T21239 105	1268 302 132	T18443 122	1268 304 252	T09048 23
1250 312 086	T08492 255	1268 302 164	T09041 126	1268 304 256	T08494 12
1250 312 087	T08530 236	1268 302 176	T63688 230	1268 304 262	T19236 43
1250 312 088	T08527 237	1268 303 001	T08442 74	1268 304 274	T09049 142
1250 312 126	T08589 135	1268 303 003	T08515 51	1268 304 285	T08454 24
1250 312 127	T08589 135	1268 303 004	T08510 46	1268 304 286	T08455 32
1250 312 159	T08466 119	1268 303 005	T08508 30	1268 304 287	T81205 43
1250 312 161	T08587 118	1268 303 006	T08507 30	1268 304 288	T08453 21
1250 312 162	T08466 119	1268 303 007	T11386 49	1268 304 289	T08276 33
1250 312 171	T08948 127	1268 303 008	T08513 50	1268 304 290	T08456 44
1250 312 220	T09040 127	1268 303 012	T08509 49	1268 304 291	T08481 17
1250 312 222	T21249 105	1268 303 032	T08442 74	1268 304 424	T15059 269
1250 312 239	T08466 119	1268 303 056	T08515 51	1268 304 445	T15346 270
1250 312 247	T08920 127	1268 303 057	T08513 50	1268 304 476	T17222 212
1250 312 270	T08466 119	1268 303 071	T21282 106	1268 304 491	T15065 276
1250 312 291	T09040 127	1268 303 093	T09042 50	1268 304 494	T15065 276
1250 312 323	T08492 255	1268 303 094	T15488 47	1268 304 510	T15096 187
1250 312 364	T08527 237	1268 303 096	T09043 47	1268 304 525	T15072 274
1250 312 366	T08530 236	1268 303 097	T09044 30	1268 304 536	T09050 45
1250 312 473	T21249 105	1268 303 132	T21282 106	1268 304 537	T09051 238
1250 319 035	T21416 108	1268 303 138	T54714 73	1268 304 538	T09052 239
1250 319 040	T21416 108	1268 303 140	T54721 69	1268 304 554	T56727 250
1252 304 064	T08843 281	1268 304 001	T08494 12	1268 304 559	T58563 45
1252 306 012	T08929 176	1268 304 002	T08481 17	1268 304 569	T54731 229
1252 306 077	T08929 176	1268 304 003	T08454 24	1268 304 594	T15346 270
1252 307 060	T21261 105	1268 304 004	T08455 32	1268 305 001	T08511 192
1252 307 068	T21261 105	1268 304 005	T08458 43	1268 305 003	T08511 192
1257 304 020	T08946 286	1268 304 006	T08457 254	1268 305 009	T08511 192
1257 304 021	T09240 282	1268 304 007	T08885 259	1268 305 092	T08837 58
1268 203 001	T08442 74	1268 304 008	T08460 196	1268 306 035	T15880 95
1268 203 002	T08442 74	1268 304 009	T08453 21	1268 307 091	T21041 101
1268 203 055	T08442 74	1268 304 010	T08276 33	1268 307 169	T21297 106
1268 204 003	T08896 13	1268 304 011	T11387 43	1268 307 170	T21041 101



OEM no.	TAS no. Pag.	OEM no.	TAS no. Pag.	OEM no.	TAS no. Pag.
1268 308 003	T21310 106	1269 302 213	T08447 128	1269 307 575	T15648 299
1268 308 012	T15866 79	1269 302 230	T18437 121	1269 307 629	T15887 87
1268 308 020	T21310 106	1269 302 269	T15572 81	1269 307 642	T21386 107
1268 312 003	T08448 118	1269 302 303	T21413 108	1269 307 643	T21374 107
1268 312 005	T08526 135	1269 302 305	T21398 108	1269 307 644	T21361 107
1268 312 013	T08920 127	1269 303 005	T08902 41	1269 307 645	T21350 107
1268 312 025	T08855 119	1269 303 006	T08898 18	1269 307 650	T21357 107
1268 312 052	T08855 119	1269 303 040	T08905 76	1269 312 005	T08478 118
1268 312 055	T08864 119	1269 303 041	T08905 76	1269 312 006	T08912 118
1268 312 102	T15872 135	1269 303 053	T08902 41	1269 312 010	T14805 127
1268 312 113	T10416 128	1269 304 003	T08837 58	1269 312 017	T08923 135
1268 312 124	T08526 135	1269 304 004	T08840 59	1269 312 018	T08912 118
1269 202 027	T08829 161	1269 304 006	T08852 25	1269 312 025	T08912 118
1269 202 033	T08829 161	1269 304 011	T08877 256	1269 312 028	T08923 135
1269 202 087	T09751 161	1269 304 013	T11770 257	1269 312 047	T08912 118
1269 202 093	T09751 161	1269 304 016	T20435 254	1269 312 049	T08912 118
1269 202 104	T08829 161	1269 304 017	T15388 279	1269 328 229	T20451 221
1269 202 909	T08445 129	1269 304 018	T10114 251	1269 328 234	T09060 187
1269 202 912	T08445 129	1269 304 021	T08875 17	1269 328 245	T08845 274
1269 202 913	T08445 129	1269 304 022	T20359 24	1269 328 253	T09060 187
1269 212 006	T14805 127	1269 304 023	T08861 238	1269 328 254	T08845 274
1269 212 025	T08923 135	1269 304 055	T08842 227	1269 328 289	T09055 274
1269 212 901	T08923 135	1269 304 060	T81230 141	1269 331 035	T21338 106
1269 232 019	T08833 180	1269 304 061	T08850 141	1269 331 036	T21326 106
1269 232 041	T08833 180	1269 304 068	T08857 196	1269 331 077	T21338 106
1269 233 002	T08872 247	1269 304 069	T08859 278	1269 331 078	T21326 106
1269 233 009	T08872 247	1269 304 071	T20443 254	1269 332 020	T08921 198
1269 233 010	T08872 247	1269 304 072	T14806 137	1269 332 025	T08919 177
1269 233 012	T11029 247	1269 304 128	T08877 256	1269 332 036	T08919 177
1269 298 904	T18589 122	1269 304 129	T11770 257	1269 332 050	T10175 178
1269 298 909	T08923 135	1269 304 130	T20359 24	1269 332 054	T08836 182
1269 298 927	T08447 128	1269 304 131	T08852 25	1269 332 055	T08925 198
1269 298 932	T20190 115	1269 304 132	T08875 17	1269 333 011	T08474 244
1269 298 933	T20190 115	1269 304 137	T08861 238	1269 333 017	T08900 260
1269 298 938	T18437 121	1269 304 138	T08468 35	1269 333 018	T09058 285
1269 298 939	T18589 122	1269 304 139	T08468 35	1269 333 024	T09058 285
1269 298 941	T08445 129	1269 304 196	T08463 238	1269 333 025	T08474 244
1269 298 942	T08447 128	1269 304 197	T08863 59	1269 333 043	T08900 260
1269 298 944	T18589 122	1269 305 003	T08506 179	1269 333 045	T08474 244
1269 301 007	T21441 100	1269 305 004	T20365 192	1269 333 047	T09058 285
1269 302 089	T18589 122	1269 305 005	T20365 192	1269 333 048	T08474 244
1269 302 094	T08445 129	1269 307 026	T21386 107	1269 333 056	T11027 234
1269 302 127	T50157 199	1269 307 200	T21374 107	1269 333 057	T08900 260
1269 302 138	T08861 238	1269 307 294	T16577 87	1269 334 002	T14758 209
1269 302 155	T15572 81	1269 307 297	T16580 299	1269 338 020	T08916 92
1269 302 161	T21398 108	1269 307 299	T21361 107	1269 338 028	T08915 92
1269 302 163	T21413 108	1269 307 514	T21350 107	1269 338 103	T23287 58
1269 302 168	T18589 122	1269 307 574	T15875 95	1269 338 110	T21429 221



OEM no.	TAS no. Pag.	OEM no.	TAS no. Pag.	OEM no.	TAS no. Pag.
1272 298 901	T08897 128	1283 304 026	T08848 55	1290 302 465	T70013 123
1272 298 904	T08897 128	1283 306 003	T09066 213	1290 302 482	T22686 129
1272 298 909	T08505 128	1285 212 005	T09216 127	1290 302 507	T22686 129
1272 298 918	T08934 128	1285 232 003	T08827 181	1290 302 511	T77004 123
1272 302 032	T08897 128	1285 233 003	T08869 246	1290 302 524	T70013 123
1272 302 095	T08505 128	1285 233 006	T08869 246	1290 303 192	T22522 73
1272 302 112	T08934 128	1285 233 007	T08869 246	1290 303 197	T22601 25
1272 303 025	T08910 47	1285 233 012	T08869 246	1290 303 198	T22530 38
1272 303 026	T08904 13	1285 302 033	T11768 80	1290 303 199	T22605 51
1272 303 027	T08906 37	1285 304 038	T11970 227	1290 303 200	T22610 71
1272 303 040	T08911 75	1285 304 104	T11970 227	1290 303 213	T74170 25
1272 303 041	T08522 18	1285 312 005	T09216 127	1290 303 221	T72375 67
1272 303 042	T08523 39	1285 312 011	T09216 127	1290 304 056	T22535 58
1272 304 058	T08465 138	1285 332 005	T08922 198	1290 304 058	T22544 193
1272 304 060	T14790 10	1285 332 011	T08532 177	1290 304 083	T38931 281
1272 304 069	T08502 35	1285 333 003	T14786 257	1290 304 090	T63098 277
1272 304 070	T14780 15	1285 333 004	T08476 239	1290 304 098	T38929 272
1272 304 075	T11765 256	1285 333 007	T08949 186	1290 304 180	T81272 249
1272 304 076	T15575 271	1285 333 008	T08890 282	1290 304 190	T63098 277
1272 304 076*	T15575 271	1285 333 018	T08476 239	1290 304 343	T55222 252
1272 304 077	T08866 282	1285 333 020	T08890 282	1290 304 350	T39059 268
1272 304 078	T08483 256	1285 333 021	T08476 239	1290 304 356	T39058 269
1272 304 079	T14790 10	1285 333 033	T08869 246	1290 304 366	T39060 268
1272 304 080	T14780 15	1285 334 017	T08924 136	1290 304 371	T22544 193
1272 304 081	T08502 35	1285 334 021	T08924 136	1290 304 379	T55222 252
1272 304 124	T15397 248	1285 334 023	T08924 136	1290 304 380	T81272 249
1272 304 130	T08893 251	1285 338 004	T08851 91	1290 304 383	T63098 277
1272 304 131	T08887 25	1286 304 022	T08842 227	1290 304 411	T81272 249
1272 304 132	T08504 17	1290 198 406	T73169 266	1290 304 412	T63098 277
1272 304 133	T14808 137	1290 203 017	T22587 289	1290 304 417	T38931 281
1272 304 134	T08894 24	1290 203 018	T22338 289	1290 304 438	T39058 269
1272 304 135	T08501 256	1290 203 039	T22522 73	1290 304 440	T69916 278
1272 304 136	T08479 238	1290 203 043	T22522 73	1290 304 472	T38929 272
1272 304 138	T08502 35	1290 204 072	T38173 261	1290 304 473	T37714 271
1272 304 139	T08502 35	1290 204 073	T18614 267	1290 304 474	T38929 272
1272 304 166	T15575 271	1290 204 075	T84569 263	1290 304 477	T23668 19
1272 307 025	T16564 87	1290 204 079	T84569 263	1290 304 480	T22558 31
1272 333 014	T08856 268	1290 204 091	T38173 261	1290 304 482	T22175 231
1272 333 019	T08856 268	1290 298 905	T75012 114	1290 304 488	T77281 229
1272 333 020	T14786 257	1290 298 920	T80289 172	1290 304 505	T22175 231
1272 333 027	T14786 257	1290 301 030	T38719 97	1290 304 508	T22183 240
1272 334 003	T08930 214	1290 301 035	T38710 99	1290 304 509	T22188 229
1281 305 001	T08506 179	1290 301 073	T21022 101	1290 304 510	T23668 19
1283 303 002	T14796 74	1290 301 140	T21022 101	1290 304 515	T22689 49
1283 304 004	T08848 55	1290 301 145	T38719 97	1290 304 546	T22558 31
1283 304 006	T08488 194	1290 301 146	T38710 99	1290 304 547	T22689 49
1283 304 007	T14776 137	1290 302 023	T10176 235	1290 304 572	T22693 9
1283 304 022	T08488 194	1290 302 396	T77004 123	1290 304 573	T22696 93





OEM no.	TAS no. Pag.	OEM no.	TAS no. Pag.	OEM no.	TAS no. Pag.
1290 304 574	T22558 31	1295 202 035	T09751 161	1295 304 202	T15719 11
1290 304 581	T23668 19	1295 202 041	T09751 161	1295 304 206	T19360 94
1290 304 586	T22699 255	1295 212 009	T53418 300	1295 304 236	T19111 36
1290 304 618	T22704 257	1295 233 018	T09063 244	1295 304 245	T09763 143
1290 304 619	T22704 257	1295 233 024	T09063 244	1295 304 247	T15359 226
1290 304 620	T22193 144	1295 233 025	T09063 244	1295 304 248	T15377 226
1290 305 025	T22562 191	1295 233 029	T08908 247	1295 304 278	T08871 241
1290 305 026	T22562 191	1295 233 031	T09063 244	1295 304 278/M	T44643 234
1290 305 029	T22562 191	1295 298 801	T54571 204	1295 304 294	T08871 241
1290 305 031	T22562 191	1295 298 910	T09793 130	1295 304 322	T09759 37
1290 305 034	T22562 191	1295 298 915	T20194 115	1295 306 041	T21494 108
1290 306 066	T22880 216	1295 298 917	T20200 112	1295 306 132	T08933 213
1290 306 423	T22894 216	1295 298 932	T54571 204	1295 307 053	T21534 109
1290 306 439	T22898 215	1295 298 948	T46662 155	1295 307 054	T21566 110
1290 312 167	T38731 100	1295 298 960	T20200 112	1295 307 076	T21520 109
1290 312 249	T38731 100	1295 302 070	T19448 64	1295 307 160	T45524 54
1290 395 013	T81271 230	1295 302 071	T09771 61	1295 307 162	T21508 109
1290 395 021	T81270 228	1295 302 074	T15362 62	1295 307 243	T19116 176
1290 395 134	T55219 234	1295 302 086	T09793 130	1295 307 274	T18581 299
1290 395 193	T38931 281	1295 302 122	T19500 63	1295 307 392	T21547 109
1290 395 311	T38929 272	1295 302 129	T19096 133	1295 307 423	T21558 109
1290 395 332	T38929 272	1295 302 158	T11171 130	1295 307 479	T18869 79
1292 298 905	T46784 156	1295 302 168	T19500 63	1295 333 012	T09058 285
1292 303 004	T08828 75	1295 303 025	T19986 29	1295 334 027	T08932 215
1292 303 005	T08521 41	1295 303 026	T09783 27	1295 334 075	T18748 210
1292 303 006	T08909 18	1295 303 027	T09785 38	1295 338 012	T19927 57
1292 304 017	T14188 194	1295 303 028	T19455 39	1295 338 059	T14811 92
1292 304 018	T14279 137	1295 303 036	T09799 45	1295 338 061	T54515 91
1292 304 025	T14275 280	1295 303 037	T09787 46	1295 338 083	T19927 57
1292 304 026	T14271 254	1295 303 053	T09781 76	1295 698 191	T20194 115
1292 304 027	T08865 59	1295 303 054	T19464 78	1296 202 001	T11173 130
1292 304 035	T14218 142	1295 303 060	T19506 70	1296 202 004	T15119 129
1292 304 036	T11776 10	1295 303 066	T09781 76	1296 207 004	T61510 186
1292 304 040	T08888 257	1295 303 067	T19464 78	1296 207 006	T63581 186
1292 304 041	T09057 256	1295 303 092	T19506 70	1296 233 005	T08908 247
1292 304 045	T11776 10	1295 303 097	T09787 46	1296 233 006	T08908 247
1292 304 046	T08879 25	1295 303 098	T09785 38	1296 233 008	T08908 247
1292 304 047	T08491 35	1295 303 101	T09787 46	1296 301 004	T21467 102
1292 304 052	T08888 257	1295 303 103	T09785 38	1296 301 005	T21453 102
1292 304 053	T50369 140	1295 303 105	T09783 27	1296 301 007	T21441 100
1292 304 069	T08889 142	1295 304 002	T09056 283	1296 301 189	T21467 102
1292 304 070	T50369 140	1295 304 004	T15151 272	1296 302 003	T11161 44
1292 305 002	T19280 191	1295 304 121	T15708 16	1296 302 007	T11173 130
1292 305 004	T19280 191	1295 304 127	T15731 21	1296 302 023	T14807 44
1295 202 001	T19096 133	1295 304 128	T11158 23	1296 302 033	T15119 129
1295 202 004	T09793 130	1295 304 135	T09759 37	1296 303 002	T11169 38
1295 202 019	T19096 133	1295 304 136	T15713 36	1296 303 009	T11163 27
1295 202 028	T11171 130	1295 304 165	T08858 241	1296 303 014	T11165 46



OEM no.	TAS no. Pag.	OEM no.	TAS no. Pag.	OEM no.	TAS no. Pag.
1296 303 020	T15364 76	1297 302 071	T09773 62	1297 304 030	T18353 143
1296 303 025	T15364 76	1297 302 074	T15014 62	1297 304 031	T08892 250
1296 304 087	T11156 23	1297 302 079	T19521 61	1297 304 035	T09757 59
1296 304 090	T11154 37	1297 302 160	T09791 130	1297 304 041	T08871 241
1296 304 119	T19135 142	1297 302 173	T15053 130	1297 304 112	T09769 16
1296 304 135	T08874 274	1297 302 176	T09773 62	1297 304 113	T19476 15
1296 307 046	T21562 110	1297 302 177	T11774 63	1297 304 115	T09775 22
1296 312 003	T16712 211	1297 302 231	T15053 130	1297 304 119	T09777 279
1296 312 016	T16712 211	1297 302 241	T19521 61	1297 304 120	T09779 280
1296 312 042	T16712 211	1297 303 009	T09789 26	1297 304 123	T19530 36
1296 328 002	T15084 274	1297 303 010	T15755 28	1297 304 127	T09767 31
1296 333 002	T08899 260	1297 303 021	T19288 26	1297 304 128	T19481 31
1296 333 007	T08908 247	1297 303 022	T19288 26	1297 304 148	T44698 194
1296 333 011	T09062 285	1297 303 025	T15047 39	1297 304 150	T18326 11
1296 333 015	T08899 260	1297 303 026	T15026 37	1297 304 151	T19293 10
1296 333 022	T15084 274	1297 303 039	T15033 46	1297 304 152	T18889 12
1296 333 023	T09062 285	1297 303 040	T15040 46	1297 304 153	T15736 10
1296 333 024	T11732 246	1297 303 041	T19526 39	1297 304 154	T19368 94
1296 333 033	T15084 274	1297 303 042	T19975 27	1297 304 175	T19483 35
1296 333 039	T20689 91	1297 303 043	T19971 71	1297 304 179	T19074 143
1296 333 044	T15084 274	1297 303 045	T18339 77	1297 304 181	T18353 143
1296 333 045	T15084 274	1297 303 046	T15751 78	1297 304 187	T15383 226
1296 333 046	T20689 91	1297 303 047	T11167 76	1297 304 195	T08895 259
1296 333 050	T18042 244	1297 303 051	T19952 70	1297 304 196	T09054 246
1296 334 003	T18748 210	1297 303 053	T18339 77	1297 304 260	T15019 36
1296 334 004	T17892 214	1297 303 054	T15751 78	1297 304 261	T18328 22
1296 334 026	T18748 210	1297 303 064	T18339 77	1297 304 262	T18889 12
1296 334 046	T18748 210	1297 303 065	T15026 37	1297 304 263	T18313 16
1297 198 400	T38841 187	1297 303 066	T15033 46	1297 304 266	T15727 21
1297 202 005	T09791 130	1297 303 067	T09789 26	1297 304 267	T15016 36
1297 202 013	T15053 130	1297 303 072	T15047 39	1297 304 269	T15724 15
1297 202 030	T09791 130	1297 303 073	T15755 28	1297 304 270	T15736 10
1297 202 038	T15053 130	1297 303 074	T15040 46	1297 304 285	T19530 36
1297 202 053	T15053 130	1297 303 075	T15751 78	1297 304 318	T19483 35
1297 232 027	T19961 179	1297 303 077	T19288 26	1297 304 351	T08946 286
1297 232 039	T19961 179	1297 303 085	T19975 27	1297 304 369	T16723 242
1297 233 018	T14809 245	1297 303 086	T19971 71	1297 304 371	T16726 245
1297 233 042	T14809 245	1297 303 098	T19952 70	1297 304 372	T64683 277
1297 233 056	T15934 243	1297 303 123	T19526 39	1297 304 373	T18028 275
1297 233 057	T14809 245	1297 303 132	T19975 27	1297 304 401	T18028 275
1297 233 059	T50174 232	1297 303 135	T15047 39	1297 304 402	T15078 272
1297 298 800	T51387 173	1297 303 140	T18339 77	1297 304 413	T19530 36
1297 298 801	T51388 112	1297 304 016	T15724 15	1297 304 415	T64683 277
1297 298 955	T81474 261	1297 304 017	T18313 16	1297 304 433	T15078 272
1297 302 012	T15567 80	1297 304 019	T15727 21	1297 304 436	T15096 187
1297 302 022	T21480 102	1297 304 020	T18328 22	1297 304 441	T18889 12
1297 302 042	T15569 80	1297 304 025	T15016 36	1297 304 442	T18313 16
1297 302 070	T11774 63	1297 304 026	T15019 36	1297 304 450	T64683 277



OEM no.	TAS no. Pag.	OEM no.	TAS no. Pag.	OEM no.	TAS no. Pag.
1297 304 484	T15078 272	1304 302 384	T72388 124	1304 304 660	T55074 232
1297 304 485	T18028 275	1304 302 388	T57537 131	1304 304 664	T19735 281
1297 304 505	T15078 272	1304 302 405	T76676 129	1304 304 672	T61199 196
1297 304 507	T17871 267	1304 302 415	T57529 131	1304 304 680	T38285 270
1297 304 515	T17870 283	1304 302 425	T19727 236	1304 304 683	T38313 270
1297 306 028	T08933 213	1304 302 430	T54510 131	1304 304 686	T15151 272
1297 306 120	T17901 213	1304 302 440	T20709 174	1304 304 687	T69054 252
1297 332 005	T15739 177	1304 302 473	T50173 126	1304 304 688	T38320 281
1297 332 017	T20043 182	1304 303 283	T74488 64	1304 304 697	T77284 252
1297 332 035	T53412 182	1304 303 291	T70031 73	1304 306 107	T22902 215
1297 332 036	T53410 197	1304 303 292	T77641 13	1304 307 013	T21843 111
1297 332 080	T53410 197	1304 303 293	T59014 23	1304 307 177	T21843 111
1297 332 109	T15739 177	1304 303 294	T70037 64	1304 332 019	T60303 179
1297 332 120	T50171 182	1304 304 011	T50176 249	1304 332 059	T74163 198
1297 333 115	T55145 251	1304 304 012	T38279 235	1304 332 060	T74157 182
1297 333 139	T09062 285	1304 304 050	T22223 56	1304 332 066	T59041 250
1297 338 010	T80238 91	1304 304 051	T56218 251	1304 332 075	T59073 243
1297 338 038	T14812 91	1304 304 056	T55074 232	1304 332 089	T19816 284
(1299 304 875)	T12197 240	1304 304 062	T19795 283	1304 332 111	T60303 179
(1299 304 882)	T12198 240	1304 304 076	T19786 240	1304 332 178	T74163 198
1304 202 061	T72388 124	1304 304 132	T38285 270	1304 332 210	T61284 60
1304 202 103	T72388 124	1304 304 134	T15151 272	1304 332 215	T61274 61
1304 202 115	T76676 129	1304 304 134*	T15151 272	1304 333 005	T19824 267
1304 202 168	T72388 124	1304 304 408	T19786 240	1304 333 011	T19832 286
1304 202 177	T57537 131	1304 304 443	T22240 254	1304 403 204	T65816 161
1304 202 190	T57529 131	1304 304 444	T37633 280	1306 304 085	T22149 268
1304 202 203	T76676 129	1304 304 448	T74139 227	1307 198 412	T58569 188
1304 202 208	T54510 131	1304 304 496	T38285 270	1307 202 006	T10118 129
1304 202 214	T53975 237	1304 304 515	T50176 249	1307 202 018	T22336 292
1304 202 245	T50173 126	1304 304 516	T60913 119	1307 202 041	T10118 129
1304 204 059	T84569 263	1304 304 541	T19795 283	1307 202 116	T22336 292
1304 232 051	T81209 185	1304 304 543	T22231 137	1307 202 123	T10118 129
1304 232 083	T54521 190	1304 304 553	T22211 194	1307 202 140	T53562 125
1304 232 085	T54521 190	1304 304 575	T59047 250	1307 202 149	T39079 134
1304 233 006	T19778 247	1304 304 576	T59054 253	1307 202 150	T39079 134
1304 233 011	T19778 247	1304 304 582	T77628 14	1307 202 154	T53562 125
1304 233 013	T50174 232	1304 304 586	T81195 9	1307 202 163	T53562 125
1304 242 006	T23294 210	1304 304 588	T59009 225	1307 202 166	T37664 131
1304 298 902	T49492 117	1304 304 591	T22317 248	1307 202 167	T37665 134
1304 298 910	T50181 204	1304 304 597	T19795 283	1307 202 168	T37664 131
1304 298 914	T49492 117	1304 304 604	T59035 139	1307 202 169	T37665 134
1304 301 305	T21037 99	1304 304 623	T38930 233	1307 203 009	T23809 288
1304 302 006	T38271 236	1304 304 630	T85132 141	1307 203 010	T23809 288
1304 302 150	T74483 64	1304 304 636	T59019 20	1307 203 019	T23809 288
1304 302 169	T60731 69	1304 304 637	T59004 19	1307 204 043	T22111 44
1304 302 188	T38271 236	1304 304 645	T69054 252	1307 204 056	T52620 290
1304 302 259	T19727 236	1304 304 651	T59047 250	1307 204 084	T76659 262
1304 302 364	T20709 174	1304 304 653	T77284 252	1307 204 093	T76659 262



OEM no.	TAS no. Pag.	OEM no.	TAS no. Pag.	OEM no.	TAS no. Pag.
1307 204 128	T76659 262	1307 304 156	T09557 215	1307 395 192	T93563 232
1307 204 158	T23740 43	1307 304 159	T09562 275	1307 395 316	T22169 72
1307 204 170	T22111 44	1307 304 166	T12132 247	1307 395 318	T23789 29
1307 204 173	T23740 43	1307 304 167	T09559 259	1307 395 322	T23726 45
1307 204 230	T22103 258	1307 304 168	T15353 252	1308 202 038	T81217 125
1307 204 243	T76659 262	1307 304 175	T09561 273	1308 202 052	T81217 125
(1307 204 244/HUB)	T15353 252	1307 304 181	T09562 275	1308 232 007	T80301 185
1307 204 266	T74672 262	1307 304 182	T09563 273	1308 233 001	T72403 233
1307 204 268	T23763 195	1307 304 188	T10069 284	1308 233 003	T72403 233
1307 204 270	T23690 11	1307 304 189	T10068 286	1308 298 001	T75426 116
1307 204 271	T23670 17	1307 304 190	T18371 284	1308 302 096	T81217 125
1307 204 273	T23710 15	1307 304 262	T22131 273	1308 303 023	T80212 68
1307 204 274	T23699 12	1307 304 268	T09563 273	1308 303 027	T80182 29
1307 204 275	T52620 290	1307 304 352	T09511 138	1308 304 059	T80341 226
1307 204 277	T23740 43	1307 304 370	T10068 286	1308 304 064	T15642 20
1307 204 279	T22111 44	1307 304 371	T18371 284	1308 304 065	T12132 247
1307 204 291	T23763 195	1307 304 372	T10069 284	1308 304 066	T15353 252
1307 204 292	T23778 195	1307 304 451	T22117 243	1308 304 074	T12124 286
1307 204 293	T43994 265	1307 304 544	T23755 284	1308 304 078	T12138 243
1307 204 303	T23670 17	1307 304 574	T93563 232	1308 304 087	T77125 277
1307 204 304	T23710 15	1307 304 588	T22131 273	1308 304 091	T12124 286
1307 204 306	T23690 11	1307 304 589	T22149 268	1308 304 095	T22131 273
1307 204 307	T23699 12	1307 304 607	T15353 252	1308 304 097	T22131 273
1307 204 309	T23763 195	1307 304 608	T12132 247	1308 304 110	T12132 247
1307 204 310	T23778 195	1307 304 623	T23677 144	1308 332 015	T80358 278
1307 204 316	T23732 20	1307 304 626	T22117 243	1310 203 001	T80220 75
1307 204 317	T76666 264	1307 304 628	T22124 228	1310 298 018	T76355 115
1307 204 323	T22111 44	1307 304 632	T23710 15	1310 302 001	T38433 126
1307 204 325	T23740 43	1307 304 633	T23670 17	1310 302 023	T37946 236
1307 204 343	T23721 20	1307 304 638	T23732 20	1310 302 024	T72418 235
1307 295 235	T22111 44	1307 304 640	T23721 20	1310 302 026	T81218 125
1307 298 001	T74672 262	1307 304 643	T22131 273	1310 302 045	T50549 229
1307 298 030	T38751 113	1307 304 644	T22149 268	1310 302 089	T63679 120
1307 298 930	T38751 113	1307 304 649	T23778 195	1310 303 021	T80220 75
1307 302 109	T45797 231	1307 304 650	T23763 195	1310 303 031	T38983 26
1307 303 014	T22169 72	1307 304 652	T23699 12	1310 303 032	T38437 73
1307 303 015	T09548 41	1307 304 653	T23690 11	1310 303 033	T38441 50
1307 303 059	T23798 29	1307 304 668	T10068 286	1310 303 051	T38445 38
1307 303 060	T23772 72	1307 304 669	T18371 284	1310 303 053	T77268 74
1307 303 104	T23748 78	1307 304 670	T10069 284	1310 303 056	T57310 73
1307 303 107	T37663 79	1307 304 671	T23755 284	1310 303 059	T77231 48
1307 303 110	T23789 29	1307 305 014	T23800 193	1310 303 062	T77244 37
1307 303 116	T23798 29	1307 305 025	T23794 193	1310 303 065	T77256 26
1307 303 122	T22169 72	1307 305 026	T23800 193	1310 303 069	T57310 73
1307 303 123	T23772 72	1307 395 079	T56734 75	1310 303 072	T77256 26
1307 304 054	T09511 138	1307 395 088	T22124 228	1310 303 076	T80220 75
1307 304 114	T77125 277	1307 395 089	T22117 243	1310 303 078	T77256 26
1307 304 149	T12132 247	1307 395 124	T45797 231	1310 304 063	T17872 286



OEM no.	TAS no. Pag.	OEM no.	TAS no. Pag.	OEM no.	TAS no. Pag.
1310 304 067	T17872 286	1312 304 052	T17886 258	1314 302 138	T57321 162
1310 304 080	T38449 258	1312 304 056	T15103 242	1314 303 077	T57530 219
1310 304 085	T38458 24	1312 304 060	T39104 298	1314 304 097	T60592 174
1310 304 088	T38463 33	1312 304 082	T20539 56	1314 304 119	T57401 93
1310 304 091	T37950 42	1312 304 084	T20643 58	1314 312 018	T57551 213
1310 304 096	T15072 274	1312 304 097	T19997 174	1314 332 043	T62174 175
1310 304 108	T11729 242	1312 304 102	T14989 285	1314 333 031	T72472 234
1310 304 112	T38458 24	1312 304 106	T15090 245	1315 202 018	T20132 162
1310 304 138	T73141 42	1312 304 107	T14989 285	1315 202 022	T17603 133
1310 304 157	T37954 259	1312 304 124	T18461 93	1315 202 037	T17692 132
1310 304 158	T63695 249	1312 304 134	T17825 143	1315 202 038	T60321 133
1310 304 161	T63688 230	1312 304 150	T19997 174	1315 202 039	T38332 132
1310 304 174	T14983 284	1312 304 153	T17825 143	1315 202 040	T20227 132
1310 304 175	T14989 285	1312 304 157	T14989 285	1315 202 070	T94385 134
1310 304 178	T73138 32	1312 304 158	T18047 260	1315 202 071	T94081 131
1310 304 186	T73149 23	1312 304 159	T17222 212	1315 204 006	T18625 262
1310 304 189	T63682 138	1312 304 181	T18047 260	1315 207 011	T69843 55
1310 304 195	T38877 282	1313 202 013	T11730 133	1315 207 014	T69843 55
1310 304 202	T14983 284	1313 207 003	T61510 186	1315 221 002	T62193 121
1310 304 225	T14983 284	1313 207 005	T63581 186	1315 232 010	T20230 185
1310 304 232	T60313 229	(1313 232 003/G)	T20580 184	1315 232 013	T20235 181
1311 198 401	T53406 266	1313 233 001	T14809 245	1315 232 016	T20235 181
1311 212 024	T38877 282	1313 301 036	T21441 100	1315 232 017	T20235 181
1311 298 012	T38877 282	1313 301 037	T21453 102	1315 232 027	T43982 180
1311 302 022	T80344 228	1313 301 038	T21467 102	1315 233 006	T11732 246
1311 304 009	T37959 235	1313 302 001	T20005 66	1315 233 023	T73359 191
1311 304 010	T19748 271	1313 302 014	T21480 102	1315 245 016/KIT	T22079 96
1311 304 011	T19735 281	1313 302 030	T11730 133	1315 245 017/KIT	T22091 96
1311 304 015	T53982 228	1313 302 036	T20005 66	1315 298 001	T19441 117
1311 304 076	T19748 271	1313 303 003	T20010 41	1315 298 001P	T93874 116
1311 304 102	T19795 283	1313 303 004	T20016 71	1315 298 002	T19427 172
1311 304 103	T19735 281	1313 304 005	T20022 33	1315 298 003	T19433 172
1311 304 177	T19795 283	1313 304 008	T18287 260	1315 298 008	T80878 264
1311 304 180	T53982 228	1313 304 009	T18035 246	1315 298 054	T75736 262
1311 304 225	T37974 141	1313 304 036	T19190 60	1315 298 055	T80504 264
1311 304 226	T37967 255	1313 304 038	T20028 59	1315 298 060	T75736 262
1311 304 248	T37974 141	1313 304 072	T17834 143	1315 301 005	T21867 104
1311 304 255	T19748 271	1313 306 012	T21494 108	1315 301 007	T21861 102
1311 312 043	T38877 282	1313 307 001	T21566 110	1315 301 034	T21879 100
1312 202 017	T18533 175	1313 307 002	T21508 109	1315 301 094	T38530 97
1312 204 035	T18625 262	1313 307 003	T21520 109	1315 301 095	T38530 97
1312 204 037	T18625 262	1313 307 004	T21534 109	1315 301 233	T21867 104
1312 204 043	T18625 262	1313 307 005	T21547 109	1315 301 234	T21879 100
1312 298 901	T61735 173	1313 307 006	T21558 109	1315 302 008	T18554 65
1312 298 911	T18625 262	1313 307 020	T21566 110	1315 302 043	T17603 133
1312 302 055	T14983 284	1313 307 022	T21562 110	1315 302 086	T17603 133
1312 302 095	T18533 175	1313 333 001	T18052 260	1315 302 116	T20138 162
1312 304 027	T11729 242	1314 202 039	T20132 162	1315 302 117	T20143 161



OEM no.	TAS no. Pag.	OEM no.	TAS no. Pag.	OEM no.	TAS no. Pag.
1315 302 120	T20138 162	1315 304 131	T17608 139	1316 245 013/KIT	T22077 96
1315 302 121	T20143 161	1315 304 132	T19190 60	1316 298 037 MO	T80878 264
1315 302 153	T17692 132	1315 304 135	T17870 283	1316 301 022	T21934 111
1315 302 157	T20505 63	1315 304 136	T17872 286	1316 301 042	T21939 103
1315 302 158	T19174 63	1315 304 380	T19542 195	1316 301 053	T38530 97
1315 302 162	T20227 132	1315 305 002	T20919 193	1316 302 014	T20471 134
1315 302 163	T38332 132	1315 305 005	T94456 192	1316 302 057	T19379 66
1315 302 164	T60321 133	1315 305 011	T20919 193	1316 302 065	T19384 65
1315 302 173	T17790 65	1315 307 012	T21903 104	1316 302 066	T19140 63
1315 302 196	T18533 175	1315 307 013	T21909 97	1316 302 067	T19388 66
1315 302 214	T17692 132	1315 307 242	T21916 100	1316 302 079	T20471 134
1315 302 215	T60321 133	1315 307 267	T21838 110	1316 302 085	T17909 134
1315 302 217	T20227 132	1315 312 017	T19201 214	1316 302 087	T38334 132
1315 303 004	T19178 28	1315 312 032	T38900 211	1316 302 103	T20471 134
1315 303 008	T20510 72	1315 312 048	T38900 211	1316 302 209	T71619 133
1315 303 010	T20515 28	1315 331 001	T21922 104	1316 302 221	T20471 134
1315 303 011	T17794 40	1315 332 032	T20249 183	1316 302 226	T17909 134
1315 303 012	T17800 71	1315 332 041	T20250 197	1316 303 002	T73344 68
1315 303 022	T62452 78	1315 332 044	T20259 178	1316 303 003	T19056 39
1315 303 027	T20148 162	1315 332 053	T20259 178	1316 303 004	T19548 41
1315 303 041	T62465 78	1315 332 073	T50178 196	1316 303 005	T19041 27
1315 303 042	T20680 76	1315 332 091	T43983 178	1316 303 006	T19393 28
1315 303 046	T17794 40	1315 334 011	T72965 200	1316 303 030	T20525 72
1315 303 048	T62452 78	1315 334 036	T38899 81	1316 303 031	T20480 71
1315 303 050	T18466 40	1315 334 041	T80296 177	1316 303 033	T19046 77
1315 303 051	T18559 70	1315 334 056	T38486 211	1316 303 034	T20484 77
1315 303 052	T17800 71	1315 334 069	T38486 211	1316 303 036	T19492 210
1315 303 060	T21891 104	1315 334 074	T72965 200	1316 303 040	T19041 27
1315 303 063	T20913 77	1316 202 025	T17909 134	1316 303 055	T20530 72
1315 303 064	T18559 70	1316 202 026	T20471 134	1316 303 056	T19145 70
1315 304 004	T19536 11	1316 202 037	T38334 132	1316 303 058	T19150 27
1315 304 006	T19542 195	1316 202 043	T71619 133	1316 303 063	T19155 40
1315 304 013	T20520 195	1316 203 001	T19492 210	1316 303 064	T19051 69
1315 304 017	T17807 33	1316 204 011	T80504 264	1316 303 065	T19056 39
1315 304 018	T18563 93	1316 204 012	T75736 262	1316 303 070	T19145 70
1315 304 025	T19184 16	1316 204 015	T75736 262	1316 303 071	T19051 69
1315 304 027	T18062 22	1316 204 017	T75736 262	1316 304 002	T19160 16
1315 304 028	T18264 21	1316 232 011	T20474 185	1316 304 003	T20488 15
1315 304 029	T18269 144	1316 232 019	T20581 181	1316 304 007	T19397 33
1315 304 043	T58475 298	1316 232 039	T43980 180	1316 304 008	T19061 22
1315 304 045	T39103 298	1316 233 010	T19375 191	1316 304 009	T20492 21
1315 304 046	T39107 298	1316 233 014	T73806 191	1316 304 010	T19401 11
1315 304 047	T39104 298	1316 233 015	T15940 245	1316 304 012	T19407 195
1315 304 048	T39105 299	1316 233 016	T73806 191	1316 304 013	T20496 10
1315 304 084	T17608 139	1316 233 028	T73806 191	1316 304 015	T20535 194
1315 304 086	T39106 298	1316 233 029	T15940 245	1316 304 078	T17872 286
1315 304 089	T17696 34	1316 245 012/KIT	T22075 96	1316 304 079	T17839 139
1315 304 130	T17834 143	1316 245 013	T22268 95	1316 304 094	T19166 22



OEM no.	TAS no. Pag.	OEM no.	TAS no. Pag.	OEM no.	TAS no. Pag.
1316 304 103	T17914 34	1316 332 140	T43981 177	1324 304 012	T22235 227
1316 304 118	T70484 140	1316 333 009	T18042 244	1324 304 013	T20867 239
1316 304 130	T17825 143	1316 333 014	T38786 56	1324 304 014	T20946 174
1316 304 132	T17839 139	1316 333 034	T20945 285	1324 304 015	T20717 14
1316 304 133	T20539 56	1317 204 056	T18637 263	1324 304 021	T22211 194
1316 304 145	T17867 241	1317 303 012	T23789 29	1324 304 028	T22235 227
1316 304 146	T17866 246	1317 303 015	T23726 45	1324 304 030	T22236 9
1316 304 147	T17868 258	1317 303 016	T23752 49	1324 304 037	T22240 254
1316 304 148	T17869 261	1317 304 026	T37642 255	1324 304 050	T75832 276
1316 304 149	T17871 267	1317 304 031	T22704 257	1324 304 052	T22317 248
1316 304 150	T17873 275	1317 304 066	T23677 144	1324 304 053	T22325 282
1316 304 152	T38706 259	1317 304 081	T11833 215	1324 304 064	T22223 56
1316 304 154	T22293 231	1317 304 114	T22196 272	1324 304 070	T22223 56
1316 304 156	T17866 246	1317 304 125	T11835 283	1324 305 001	T22306 192
1316 304 159	T17867 241	1317 304 126	T11836 281	1324 306 037	T60361 95
1316 304 162	T17868 258	1317 304 149	T22196 272	1324 306 039	T60361 95
1316 304 163	T17869 261	1317 304 150	T11838 271	1324 307 082	T21040 98
1316 304 167	T17870 283	1317 304 157	T11835 283	1324 332 001	T22307 184
1316 304 168	T17871 267	1317 304 168	T37642 255	1324 332 002	T22309 197
1316 304 169	T17872 286	1317 304 169	T22704 257	1324 332 007	T22326 181
1316 304 170	T17873 275	1324 202 014	T20710 132	1324 332 012	T22308 179
1316 304 173	T38521 276	1324 204 009	T20711 237	1324 332 016	T22308 179
1316 304 173/M	T17873 275	1324 207 033	T61510 186	1324 332 018	T22309 197
1316 304 179	T38706 259	1324 207 035	T63581 186	1324 333 019	T20866 245
1316 304 183	T22294 244	1324 232 002	T22301 184	1324 334 008	T72965 200
1316 304 185	T22295 241	1324 232 004	T23645 180	(1324/GASKET M1)	T22310 287
1316 304 186-OLD	T20895 242	1324 233 001	T20866 245	1325 233 007	T38890 233
1316 304 187	T20899 242	1324 233 006	T19778 247	1325 298 008	T80878 264
1316 304 188	T22282 283	1324 298 001	T51899 117	1325 298 009	T76138 116
1316 304 189	T22275 273	1324 298 003	T51034 262	1325 298 010	T76143 173
1316 304 190	T22279 241	1324 298 004	T51033 264	1325 298 011	T76146 160
1316 304 196	T38519 276	1324 298 013	T49360 117	1325 302 044	T41561 186
1316 304 196/M	T22275 273	1324 298 014	T49361 116	1325 302 052	T58450 80
1316 304 201	T22279 241	1324 302 029	T20710 132	1325 303 017	T60363 162
1316 304 218	T22284 240	1324 303 001	T22302 75	1325 304 223	T64370 287
1316 304 225	T14983 284	1324 303 003	T22303 40	1325 304 225	T61346 212
1316 304 235	T19407 195	1324 303 004	T22304 70	1325 333 016	T58498 90
1316 305 001	T38701 193	1324 303 007	T74493 67	1325 333 017	T38890 233
1316 305 008	T38701 193	1324 303 008	T74495 29	1325 333 018	T38889 285
1316 306 015	T19201 214	1324 303 015	T22305 13	1325 334 008	T41563 214
1316 312 011	T38901 211	1324 303 017	T22305 13	1325 334 013	T58506 211
1316 312 015	T38901 211	1324 303 018	T74495 29	1327 298 001	T37903 112
1316 332 031	T20500 184	1324 304 001	T22236 9	1327 302 005	T75473 67
1316 332 038	T20551 178	1324 304 003	T20713 32	1327 302 006	T75480 69
1316 332 054	T20250 197	1324 304 005	T20714 141	1327 304 002	T77053 18
1316 332 096	T20551 178	1324 304 006	T20715 255	1327 304 015	T60555 69
1316 332 103	T20268 181	1324 304 009	T74498 19	1327 304 024	T77053 18
1316 332 130	T20268 181	1324 304 011	T20716 236	1327 304 025	T77058 140



OEM no.	TAS no. Pag.	OEM no.	TAS no. Pag.	OEM no.	TAS no. Pag.
1327 304 031	T60555 69	1328 304 063	T57421 140	1346 302 054	T46524 121
1327 304 032	T77058 140	1328 304 064	T57387 216	1346 302 081	T41363 120
1327 304 033	T81265 212	1328 304 068	T57473 216	1346 303 007	T77186 40
1327 304 034	T64474 220	1328 306 026	T54542 95	1346 303 029	T77191 28
1327 304 035	T64476 220	1328 312 005	T57551 213	1346 303 033	T77155 51
1327 304 036	T64483 221	1328 332 009	T57455 197	1346 303 034	T77148 48
1327 304 037	T77053 18	1328 332 011	T57450 275	1346 303 038	T77148 48
1328 202 016	T78431 263	1328 332 016	T57455 197	1346 303 039	T77155 51
1328 202 039	T78431 263	1328 332 022	T61662 119	1346 303 040	T77186 40
1328 202 040	T54548 261	1328 332 023	T57475 94	1346 303 046	T77191 28
1328 202 042	T54546 269	1328 332 024	T57444 198	1346 303 064	T77198 74
1328 202 043	T54547 269	1328 332 030	T57477 225	1346 304 011	T77095 14
1328 202 046	T54546 269	1328 332 033	T57475 94	1346 304 021	T80347 249
1328 202 047	T54547 269	1328 332 041	T57495 178	1346 304 025	T39075 252
1328 202 049	T78431 263	1328 332 045	T57455 197	1346 304 026	T77141 253
1328 202 050	T54548 261	1328 332 046	T57450 275	1346 304 032	T77102 269
1328 232 006	T57504 184	1328 333 001	T54540 270	1346 304 033	T77105 268
1328 232 010	T57493 180	1328 333 003	T57487 217	1346 304 038	T38872 267
1328 232 011	T57493 180	1328 333 004	T57466 232	1346 304 039	T77102 269
1328 232 016	T57493 180	1328 333 005	T54540 270	1346 304 046	T77133 94
1328 233 001	T57479 261	1328 333 006	T57436 90	1346 304 047	T38869 235
1328 298 001	T78431 263	1328 333 009	T57466 232	1346 304 048	T77087 49
1328 298 002	T54548 261	1328 333 010	T72472 234	1346 304 054	T77095 14
1328 301 170	T57518 79	1328 334 004	T57510 214	1346 304 090	T11836 281
1328 302 011	T54546 269	1329 302 002	T41353 68	1346 304 091	T77108 251
1328 302 015	T37740 266	1329 302 004	T57360 93	1346 304 092	T77099 233
1328 302 024	T60576 86	1329 304 002	T41357 68	1346 304 093	T39076 237
1328 302 056	T57371 196	1329 304 007	T81645 9	1346 304 094	T38873 238
1328 302 061	T57360 93	1329 304 010	T81644 14	1346 304 099	T77091 32
1328 302 062	T77074 65	1329 304 011	T41357 68	1346 304 102	T60218 19
1328 302 063	T57335 68	1333 304 061	T11836 281	1346 304 107	T46525 139
1328 302 064	T37729 248	1336 302 010	T85574 187	1346 304 118	T22699 255
1328 302 070	T57337 120	1336 304 011	T77305 277	1346 304 119	T77133 94
1328 302 071	T57339 120	1336 304 017	T77380 249	1346 304 136	T60218 19
1328 302 075	T57371 196	1336 304 049	T75832 276	1346 304 173	T77141 253
1328 302 077	T57337 120	1336 304 050	T77297 230	1346 304 177	T77133 94
1328 302 078	T57339 120	1336 333 001	T77349 230	1354 302 019	T18533 175
1328 302 084	T54546 269	1336 333 004	T77396 267	1354 304 014	T57717 139
1328 302 109	T37740 266	1336 333 005	T77355 231	1354 304 015	T57725 138
1328 302 111	T54546 269	1336 333 006	T77355 231	1355 302 002	T17692 132
1328 302 118	T58944 79	1346 203 001	T77198 74	1355 302 003	T60321 133
1328 302 132	T37740 266	1346 204 002	T78329 263	1355 302 005	T20227 132
1328 302 203	T57321 162	1346 204 004	T46557 265	1355 302 012	T94385 134
1328 304 033	T57473 216	1346 204 005	T39078 264	1355 302 014	T94081 131
1328 304 035	T57423 136	1346 298 003	T78329 263	1356 204 006	T70109 265
1328 304 043	T57387 216	1346 298 004	T39078 264	1356 302 100	T17909 134
1328 304 044	T57366 66	1346 298 005	T78301 265	1356 302 114	T71619 133
1328 304 062	T57473 216	1346 302 047	T77080 123	1356 304 019	T22280 258





OEM no.	TAS no. Pag.	OEM no.	TAS no. Pag.	OEM no.	TAS no. Pag.
1356 304 022	T22281 250	2074 315 037	T15151 272	6002 306 154	T39060 268
1356 304 023	T22282 283	30217	T22214 295	6007 202 079/KIT	T22315 96
1356 304 024	T22283 276	31310A	T38138 292	6038 202 003	T45496 301
1356 304 025	T22284 240	32022X	T47570 287	6038 202 035	T66265 301
1356 304 025/M	T22279 241	32212A	T47396 293	6038 202 043	T66265 301
1356 304 026	T22285 243	32310	T37803 293	6038 202 045	T66265 301
1356 304 026/M	T17866 246	32310A	T37803 293	6085 298 013	T76346 113
1356 304 035	T17839 139	4139 333 755	T21066 210	6085 298 033	T76149 114
1358 202 020	T76058 270	4139 333 794	T21066 210	6085 298 036	T76353 113
1358 202 022	T82032 287	4415 201 145	T15631 84	6085 301 012	T51662 118
1358 232 010	T57504 184	4415 201 155	T15631 84	6090 012 002	T41955 175
1358 232 012	T72781 199	4415 301 174	T15922 297	6090 012 022	T60686 175
1358 232 013	T57504 184	4415 301 356	T15929 86	6090 012 030	T60686 175
1358 232 201	T57493 180	4415 301 416	T15923 85	6090 190 028	T75240 188
1358 298 029	T82036 287	4460 291 336	T15924 84	6090 199 009	T75241 188
1358 302 203	T73628 61	4460 291 365	T15924 84	6090 301 009	T23634 97
1358 302 224	T73631 66	4461 331 008	T15926 85	6093 204 001	T54539 190
1358 302 261	T76072 176	4461 391 005	T15928 297	6093 204 007	T54539 190
1358 302 262	T76007 266	4461 391 018	T15926 85	6093 204 010	T54539 190
1358 302 283	T76062 277	4461 391 021	T15929 86	6093 304 079	T79969 210
1358 303 222	T79144 218	4461 391 029	T15929 86	61814-Y-C3	T47446 53
1358 304 222	T73634 13	4472 353 098	T18571 84	61915-A	T47385 53
1358 304 238	T73637 9	4472 353 157	T18576 225	6209NC3	T38058 52
1358 304 247	T57473 216	4472 353 158	T18576 225	635245	T38154 82
1358 304 253	T78819 217	4472 353 419	T18807 85	722013010	T46785 149
1358 332 015	T73652 88	4472 353 463	T18571 84	8098 633 001	T93807 173
1358 332 221	T57444 198	4472 353 600	T18571 84	8098 633 003	T93807 173
1358 332 222	T57450 275	512533	T47477 82	8098 633 014	T93807 173
1358 332 223	T57475 94	539244B	T22220 53	87486	T38025 81
1358 332 229	T57495 178	540106	T38154 82	9999 888 662	T46888 147
1358 332 244	T57477 225	566616 B	T23890 84	(9S1110/G & S KIT)	T45294 113
1358 332 247	T57477 225	568742A	T22208 295	(9S1110/SYNCHRO KIT)	T45296 266
1358 333 012	T57487 217	575194	T38142 295	BB1 3167	T22337 52
1358 333 020	T57487 217	5838 300 094	T21685 202	BB1 3357	T55355 52
1360 303 134	T67103 233	5838 300 279	T09545 207	BC1B 319552	T23890 84
1360 304 146	T67105 232	5840 303 205	T09545 207	BT1B 329154/Q/CL7C	T23803 288
1360 304 191	T67106 248	5841 300 574	T22210 295	F 88545	T38014 82
1499 298 003	T19341 222	5841 300 586	T20788 90	F 88816.2	T37993 83
1499 298 023	T38987 222	5841 302 094	T20790 121	F 90836.1A	T38006 83
1499 298 024	T39086 222	5961 307 148	T62175 160	F-20339	T46878 153
1499 298 025	T38988 222	6001 301 056	T08950 225	F-211408.05	T38047 83
1499 298 026	T39085 223	6001 302 082	T23305 302	F-211413.02	T22335 83
1499 298 027	T38989 223	6002 304 493	T37714 271	F-212875.01	T49199 155
1499 298 156	T39088 222	6002 304 628	T08949 186	F-217112	T49209 147
1499 298 160	T39087 221	6002 304 852	T38320 281	F-233439	T51474 151
16015.C3	T47553 53	6002 305 511	T38320 281	F-50908	T46888 147
201052	T54551 290	6002 305 661	T37714 271	F-553952	T46704 153
2050 309 066	T61323 218	6002 305 994	T69916 278	F-553954	T46712 153



OEM no.	TAS no. Pag.	OEM no.	TAS no. Pag.	OEM no.	TAS no. Pag.
F-58242	T46847 152	TAS57478	T57478 57		
F-58637	T46785 149	TAS57480	T57480 89		
F-58723	T46856 148	TAS63513	T63513 183		
F-59437	T46816 150	TAS63514	T63514 183		
F-803621	T22214 295	TAS66649	T66649 117		
F-809306	T22219 291	TAS73315	T73315 263		
F-84992	T46712 153	TAS73976	T73976 183		
F-87588	T46834 151	TAS75960	T75960 114		
F-87629	T47477 82	TAS78683	T78683 87		
F-87934	T46704 153	TAS94247	T94247 200		
F-88404	T46721 151	TAS94368	T94368 87		
F-88405	T46731 153	TAS94453	T94453 183		
F-88416	T46794 151	TAS94563	T94563 113		
HDB070	T23286 289	TAS94566	T94566 114		
JXC 25662 C	T22221 288	TAS94569	T94569 111		
JXC 25665 CC	T37644 288	TAS94572	T94572 114		
K 45X53X21 A	T46897 146	TAS94575	T94575 112		
K 62X70X40 ZW	T46801 148	VKHB 2004	T37785 290		
K 80X88X46 ZW A	T46931 152	VKHB 2015	T23272 290		
K 95X103X40 ZW A	T46924 155	VKHB 2023	T23885 293		
K4369	T22216 290	VKHB 2065	T22670 289		
K47490-47420	T22215 294	VKHB 2067	T54551 290		
(KIT-R9)	T15918 85	VKHB 2070	T37803 293		
(KIT-S9)	T15919 85	VKHB 2182	T23286 289		
OE1307 304 175	T67102 273	VKHB 2232	T22210 295		
SET 1034	T49029 294	VKHB 2249	T54551 290		
SET 1052	T47570 287	VKHB 2272	T37914 291		
SET 1058	T23272 290	VKHB 2281	T47570 287		
SET 1061	T47396 293	VKHB 2334	T22214 295		
SET 1078	T37785 290	VKHB 2347	T47396 293		
SET 1107	T23286 289	VKHB 2401 S	T37803 293		
SET 1108	T22670 289	VKT 8490	T22214 295		
SET 1109	T54551 290	VKT 8690	T47396 293		
SET 1116	T22210 295	VKT 8906	T22335 83		
SET 1127	T22218 292	VKT 8955	T22218 292		
SET 1133	T22219 291	VKT 8956	T22216 290		
SET 238	T22212 289	VKT 8957	T23803 288		
SET 271	T22217 292				
SET 315	T23885 293				
SET 318	T37914 291				
SET 342	T59348 293				
SET 928	T22215 294				
TAS41517	T41517 303				
TAS41972	T41972 265				
TAS45294	T45294 113				
TAS45296	T45296 266				
TAS49334	T85645 163				
TAS51899	T51899 117				



TAS no.	OEM no.	Pag.	TAS no.	OEM no.	Pag.	TAS no.	OEM no.	Pag.
T08276	1268 304 010	33	T08465	1272 304 058	138	T08506	1269 305 003	179
T08276	1268 304 289	33	T08466	1250 312 270	119	T08506	1240 305 005	179
T08277	1250 304 388	142	T08466	1250 312 159	119	T08506	1281 305 001	179
T08339	1250 302 196	122	T08466	1250 312 162	119	T08507	1268 303 006	30
T08340	1250 303 062	30	T08466	1250 312 239	119	T08508	1268 303 005	30
T08340	1250 303 075	30	T08468	1269 304 139	35	T08509	1268 303 012	49
T08340	1250 303 038	30	T08468	1269 304 138	35	T08510	1268 303 004	46
T08440	1250 203 002	74	T08470	1250 304 384	42	T08511	1268 305 009	192
T08440	1250 303 032	74	T08470	1250 304 137	42	T08511	1268 305 001	192
T08440	1250 303 099	74	T08470	1250 304 181	42	T08511	1268 305 003	192
T08442	1268 203 001	74	T08474	1269 333 048	244	T08513	1268 303 057	50
T08442	1268 203 002	74	T08474	1269 333 011	244	T08513	1268 303 008	50
T08442	1268 203 055	74	T08474	1269 333 025	244	T08515	1268 303 056	51
T08442	1268 303 001	74	T08474	1269 333 045	244	T08515	1268 303 003	51
T08442	1268 303 032	74	T08476	1285 333 021	239	T08517	1250 303 111	50
T08445	1269 202 913	129	T08476	1285 333 004	239	T08517	1250 303 021	50
T08445	1269 202 909	129	T08476	1285 333 018	239	T08517	1250 303 055	50
T08445	1269 202 912	129	T08478	1269 312 005	118	T08519	1250 303 112	50
T08445	1269 298 941	129	T08479	1272 304 136	238	T08519	1250 303 022	50
T08445	1269 302 094	129	T08479	1250 302 202	238	T08519	1250 303 054	50
T08447	1269 298 942	128	T08479	1250 302 242	238	T08521	1292 303 005	41
T08447	1269 298 927	128	T08479	1250 304 389	238	T08522	1272 303 041	18
T08447	1269 302 213	128	T08481	1268 304 204	17	T08523	1272 303 042	39
T08448	1268 312 003	118	T08481	1268 304 002	17	T08524	1250 305 033	192
T08449	1250 304 350	244	T08481	1268 304 291	17	T08524	1250 305 004	192
T08449	1250 304 101	244	T08483	1272 304 078	256	T08524	1250 305 007	192
T08451	1250 304 351	239	T08483	1246 304 135	256	T08526	1268 312 124	135
T08451	1250 304 312	239	T08483	1250 304 169	256	T08526	1268 312 005	135
T08451	1250 304 165	239	T08483	1250 304 229	256	T08527	1250 312 364	237
T08451	1250 204 072	239	T08486	1250 304 362	278	T08527	1250 312 088	237
T08453	1268 304 009	21	T08486	1250 304 484	278	T08530	1250 312 366	236
T08453	1268 304 288	21	T08487	1250 304 474	144	T08530	1250 312 087	236
T08454	1268 304 003	24	T08488	1283 304 022	194	T08532	1285 332 011	177
T08454	1268 304 285	24	T08488	1283 304 006	194	T08558	1250 304 240	12
T08455	1268 304 004	32	T08491	1292 304 047	35	T08558	1250 304 028	12
T08455	1268 304 286	32	T08492	1250 312 323	255	T08558	1250 304 503	12
T08456	1268 304 015	44	T08492	1250 312 086	255	T08559	1250 304 292	239
T08456	1268 304 290	44	T08494	1268 304 256	12	T08559	1250 304 228	239
T08457	1268 304 006	254	T08494	1268 304 001	12	T08559	1250 304 352	239
T08458	1268 304 005	43	T08494	1268 304 227	12	T08560	1250 303 058	48
T08459	1250 304 233	279	T08501	1272 304 135	256	T08560	1250 303 027	48
T08459	1250 304 485	279	T08502	1272 304 139	35	T08570	1250 304 029	14
T08460	1268 304 008	196	T08502	1272 304 069	35	T08570	1250 304 501	14
T08460	0091 304 341	196	T08502	1272 304 081	35	T08571	1250 304 004	280
T08461	1250 304 236	280	T08502	1272 304 138	35	T08572	1250 304 006	94
T08462	1268 302 042	126	T08504	1272 304 132	17	T08573	1250 302 199	123
T08463	1269 304 196	238	T08505	1272 298 909	128	T08574	1250 304 129	144
T08464	1268 302 001	124	T08505	1272 302 095	128	T08575	1250 304 179	20



TAS no.	OEM no.	Pag.	TAS no.	OEM no.	Pag.	TAS no.	OEM no.	Pag.
T08575	1250 304 008	20	T08856	1272 333 019	268	T08889	1292 304 069	142
T08576	1250 304 178	31	T08856	1272 333 014	268	T08890	1285 333 020	282
T08576	1250 304 070	31	T08857	1269 304 068	196	T08890	1285 333 008	282
T08577	1250 304 127	42	T08858	1295 304 165	241	T08892	1297 304 031	250
T08577	1250 304 171	42	T08859	1269 304 069	278	T08893	1272 304 130	251
T08578	1250 304 141	278	T08860	1250 304 472	275	T08894	1272 304 134	24
T08578	1250 304 050	278	T08860	1250 304 391	275	T08895	1297 304 195	259
T08579	1250 304 306	279	T08860	1250 304 535	275	T08896	1268 304 213	13
T08580	1250 304 185	253	T08861	1269 304 137	238	T08896	1268 204 003	13
T08580	1250 304 054	253	T08861	1269 302 138	238	T08896	1268 204 006	13
T08581	1250 304 234	253	T08861	1269 304 023	238	T08896	1268 204 018	13
T08582	1250 305 003	179	T08863	1269 304 197	59	T08896	1268 304 159	13
T08585	1250 304 217	31	T08864	1268 312 055	119	T08897	1272 298 904	128
T08585	1250 304 052	31	T08865	1292 304 027	59	T08897	1272 298 901	128
T08586	1250 304 210	42	T08866	1272 304 077	282	T08897	1272 302 032	128
T08587	1250 312 161	118	T08866	1250 304 167	282	T08898	1269 303 006	18
T08588	1250 303 074	47	T08866	1250 304 211	282	T08899	1296 333 002	260
T08588	1250 303 073	47	T08866	1250 304 293	282	T08899	1296 333 015	260
T08589	1250 312 126	135	T08868	1250 304 417	271	T08900	1269 333 057	260
T08589	1250 312 127	135	T08868	1240 304 206	271	T08900	1269 333 017	260
T08827	1285 232 003	181	T08868	1240 304 265	271	T08900	1269 333 043	260
T08828	1292 303 004	75	T08868	1240 304 291	271	T08902	1269 303 053	41
T08829	1269 202 104	161	T08868	1240 304 305	271	T08902	1269 303 005	41
T08829	1269 202 027	161	T08869	1285 233 007	246	T08904	1272 303 026	13
T08829	1269 202 033	161	T08869	1285 233 003	246	T08905	1269 303 041	76
T08833	1269 232 041	180	T08869	1285 233 006	246	T08905	1269 303 040	76
T08833	1269 232 019	180	T08869	1285 233 012	246	T08906	1272 303 027	37
T08836	1269 332 054	182	T08869	1285 333 033	246	T08908	1296 233 008	247
T08837	1269 304 003	58	T08871	1295 304 278	241	T08908	1296 233 006	247
T08837	1268 305 092	58	T08871	1295 304 294	241	T08908	1296 333 007	247
T08840	1269 304 004	59	T08871	1297 304 041	241	T08908	1296 233 005	247
T08842	1286 304 022	227	T08872	1269 233 010	247	T08908	1295 233 029	247
T08842	1269 304 055	227	T08872	1269 233 002	247	T08909	1292 303 006	18
T08843	1240 304 272	281	T08872	1269 233 009	247	T08910	1272 303 025	47
T08843	1240 304 205	281	T08874	1296 304 135	274	T08911	1272 303 040	75
T08843	1240 312 073	281	T08874	1246 304 278	274	T08912	1269 312 049	118
T08843	1252 304 064	281	T08875	1269 304 132	17	T08912	1269 312 006	118
T08845	1269 328 254	274	T08875	1269 304 021	17	T08912	1269 312 018	118
T08845	1269 328 245	274	T08877	1269 304 128	256	T08912	1269 312 025	118
T08847	1268 304 136	92	T08877	1269 304 011	256	T08912	1269 312 047	118
T08848	1283 304 004	55	T08879	1292 304 046	25	T08915	1269 338 028	92
T08848	1283 304 026	55	T08883	1250 304 396	257	T08916	1269 338 020	92
T08850	1269 304 061	141	T08883	1250 304 166	257	T08917	1240 317 075	217
T08851	1285 338 004	91	T08885	1268 304 150	259	T08917	1240 317 002	217
T08852	1269 304 131	25	T08885	1268 304 007	259	T08917	1240 317 005	217
T08852	1269 304 006	25	T08887	1272 304 131	25	T08917	1240 317 141	217
T08855	1268 312 052	119	T08888	1292 304 052	257	T08919	1269 332 036	177
T08855	1268 312 025	119	T08888	1292 304 040	257	T08919	1269 332 025	177



TAS no.	OEM no.	Pag.	TAS no.	OEM no.	Pag.	TAS no.	OEM no.	Pag.
T08920	1250 312 247	127	T08950	6001 301 056	225	T09216	1285 312 005	127
T08920	1268 312 013	127	T08951	0732 040 386	225	T09216	1285 312 011	127
T08921	1269 332 020	198	T08952	1250 304 142	55	T09240	1240 304 375	282
T08922	1285 332 005	198	T08953	0732 040 497	224	T09240	1240 304 212	282
T08923	1269 298 909	135	T08997	1268 302 104	124	T09240	1240 304 238	282
T08923	1269 212 025	135	T09037	0631 329 016	88	T09240	1257 304 021	282
T08923	1269 212 901	135	T09038	0631 329 048	89	T09497	0730 061 921	189
T08923	1269 312 017	135	T09038	0501 315 917	89	T09499	0730 361 046	188
T08923	1269 312 028	135	T09038	0000 104 578	89	T09499	0730 061 190	188
T08924	1285 334 023	136	T09039	0635 460 010	51	T09501	1203 321 009	224
T08924	1285 334 017	136	T09040	1250 312 291	127	T09503	0630 501 024	205
T08924	1285 334 021	136	T09040	1250 312 220	127	T09511	1307 304 352	138
T08925	1269 332 055	198	T09041	1268 302 164	126	T09511	1307 304 054	138
T08926	0730 061 890	189	T09042	1268 303 093	50	T09545	0630 501 031	207
T08927	1240 306 234	216	T09043	1268 303 096	47	T09545	5838 300 279	207
T08927	1240 306 171	216	T09044	1268 303 097	30	T09545	5840 303 205	207
T08929	1252 306 077	176	T09045	1268 304 141	56	T09547	0630 501 033	207
T08929	1252 306 012	176	T09046	1268 304 251	34	T09548	1307 303 015	41
T08930	1272 334 003	214	T09047	1268 304 143	248	T09556	0732 041 571	224
T08930	1250 306 148	214	T09048	1268 304 252	23	T09557	1307 304 156	215
T08932	1295 334 027	215	T09049	1268 304 274	142	T09559	1307 304 167	259
T08933	1297 306 028	213	T09050	1268 304 250	45	T09561	1307 304 175	273
T08933	1295 306 132	213	T09050	1268 304 536	45	T09562	1307 304 181	275
T08934	1272 298 918	128	T09051	1268 304 537	238	T09562	1307 304 159	275
T08934	1272 302 112	128	T09052	1268 304 538	239	T09563	1307 304 182	273
T08935	0735 470 027	156	T09054	1297 304 196	246	T09563	1307 304 268	273
T08936	0735 470 057	156	T09055	1269 328 289	274	T09751	1295 202 041	161
T08937	0730 150 767	301	T09056	1295 304 002	283	T09751	0091 202 057	161
T08937	0501 304 692	301	T09057	1292 304 041	256	T09751	1269 202 087	161
T08938	0730 103 102	217	T09058	1269 333 047	285	T09751	1269 202 093	161
T08939	0730 103 846	218	T09058	1269 333 018	285	T09751	1295 202 035	161
T08940	0501 305 887	295	T09058	1269 333 024	285	T09757	1297 304 035	59
T08941	0732 040 929	223	T09058	1295 333 012	285	T09759	1295 304 135	37
T08941	0732 040 735	223	T09060	1269 328 253	187	T09759	1295 304 322	37
T08946	1257 304 020	286	T09060	1269 328 234	187	T09761	1268 302 047	122
T08946	1246 304 295	286	T09062	1296 333 023	285	T09761	1268 302 007	122
T08946	1250 304 160	286	T09062	1296 333 011	285	T09763	1295 304 245	143
T08946	1297 304 351	286	T09062	0769 186 286	285	T09767	1297 304 127	31
T08947	1250 304 226	272	T09062	1297 333 139	285	T09769	1297 304 112	16
T08947	1250 304 170	272	T09063	1295 233 025	244	T09771	1295 302 071	61
T08947	1250 304 203	272	T09063	1295 233 018	244	T09773	1297 302 176	62
T08947	1250 304 215	272	T09063	1295 233 024	244	T09773	1297 302 071	62
T08947	1250 304 315	272	T09063	1295 233 031	244	T09775	1297 304 115	22
T08948	1250 312 171	127	T09064	1240 306 242	199	T09777	1297 304 119	279
T08949	1240 304 278	186	T09064	1240 306 167	199	T09779	1297 304 120	280
T08949	1285 333 007	186	T09066	1283 306 003	213	T09781	1295 303 066	76
T08949	6002 304 628	186	T09068	0732 040 736	223	T09781	1295 303 053	76
T08950	0732 040 385	225	T09216	1285 212 005	127	T09783	1295 303 026	27



TAS no.	OEM no.	Pag.	TAS no.	OEM no.	Pag.	TAS no.	OEM no.	Pag.
T09783	1295 303 105	27	T11173	1296 202 001	130	T14275	1292 304 025	280
T09785	1295 303 027	38	T11173	1296 302 007	130	T14279	1292 304 018	137
T09785	1295 303 098	38	T11386	1268 303 007	49	T14283	0730 150 064	296
T09785	1295 303 103	38	T11387	1268 304 094	43	T14451	1268 304 142	237
T09787	1295 303 101	46	T11387	1268 304 011	43	T14758	1269 334 002	209
T09787	1295 303 037	46	T11729	1312 304 027	242	T14776	1283 304 007	137
T09787	1295 303 097	46	T11729	1310 304 108	242	T14780	1272 304 080	15
T09789	1297 303 067	26	T11730	1313 202 013	133	T14780	1272 304 070	15
T09789	1297 303 009	26	T11730	1313 302 030	133	T14786	1272 333 020	257
T09791	1297 202 030	130	T11732	1315 233 006	246	T14786	1272 333 027	257
T09791	1297 202 005	130	T11732	1296 333 024	246	T14786	1285 333 003	257
T09791	1297 302 160	130	T11765	1272 304 075	256	T14790	1272 304 079	10
T09793	1295 202 004	130	T11765	1246 304 134	256	T14790	1272 304 060	10
T09793	1295 298 910	130	T11768	1285 302 033	80	T14796	1283 303 002	74
T09793	1295 302 086	130	T11770	1269 304 129	257	T14805	1269 212 006	127
T09799	1295 303 036	45	T11770	1269 304 013	257	T14805	1269 312 010	127
T09810	0091 305 012	56	T11774	1297 302 177	63	T14806	1269 304 072	137
T09810	0730 160 344	56	T11774	1297 302 070	63	T14807	1296 302 023	44
T09810	0730 160 240	56	T11776	1292 304 045	10	T14808	1272 304 133	137
T10068	1307 304 668	286	T11776	1292 304 036	10	T14809	1313 233 001	245
T10068	1307 304 189	286	T11828	0732 042 510	224	T14809	1297 233 057	245
T10068	1307 304 370	286	T11833	1317 304 081	215	T14809	1297 233 042	245
T10069	1307 304 372	284	T11835	1317 304 157	283	T14809	1297 233 018	245
T10069	1307 304 188	284	T11835	1317 304 125	283	T14810	1268 304 148	92
T10069	1307 304 670	284	T11836	1346 304 090	281	T14811	1295 338 059	92
T10114	1269 304 018	251	T11836	1333 304 061	281	T14812	1297 338 038	91
T10118	1307 202 041	129	T11836	1317 304 126	281	T14983	1310 304 202	284
T10118	1307 202 123	129	T11838	1317 304 150	271	T14983	1310 304 174	284
T10118	1307 202 006	129	T11970	1285 304 038	227	T14983	1316 304 225	284
T10134	(000 260 1597/G)	185	T11970	1285 304 104	227	T14983	1310 304 225	284
T10171	1238 304 383	234	T12124	1308 304 091	286	T14983	1312 302 055	284
T10171	1238 304 363	234	T12124	1308 304 074	286	T14989	1310 304 175	285
T10175	1269 332 050	178	T12132	1308 304 110	247	T14989	1312 304 107	285
T10176	1290 302 023	235	T12132	1308 304 065	247	T14989	1312 304 157	285
T10416	1268 312 113	128	T12132	1307 304 608	247	T14989	1312 304 102	285
T10923	1238 302 188	123	T12132	1307 304 166	247	T15014	1297 302 074	62
T11027	1269 333 056	234	T12132	1307 304 149	247	T15016	1297 304 267	36
T11029	1269 233 012	247	T12138	1308 304 078	243	T15016	1297 304 025	36
T11154	1296 304 090	37	T12197	(1299 304 875)	240	T15019	1297 304 260	36
T11156	1296 304 087	23	T12198	(1299 304 882)	240	T15019	1297 304 026	36
T11158	1295 304 128	23	T12301	1250 307 541	299	T15026	1297 303 065	37
T11161	1296 302 003	44	T13440	0732 040 409	223	T15026	1297 303 026	37
T11163	1296 303 009	27	T13452	1238 304 394	212	T15033	1297 303 066	46
T11165	1296 303 014	46	T13455	1249 304 222	187	T15033	0091 303 171	46
T11167	1297 303 047	76	T13455	1249 304 215	187	T15033	0091 303 173	46
T11169	1296 303 002	38	T14188	1292 304 017	194	T15033	1297 303 039	46
T11171	1295 202 028	130	T14218	1292 304 035	142	T15040	1297 303 074	46
T11171	1295 302 158	130	T14271	1292 304 026	254	T15040	1297 303 040	46



TAS no.	OEM no.	Pag.	TAS no.	OEM no.	Pag.	TAS no.	OEM no.	Pag.
T15040	0091 303 174	46	T15362	1295 302 074	62	T15755	1297 303 073	28
T15040	0091 303 172	46	T15364	1296 303 025	76	T15755	1297 303 010	28
T15047	1297 303 072	39	T15364	1296 303 020	76	T15760	0750 119 143	156
T15047	1297 303 025	39	T15366	0501 398 371	120	T15760	0750 119 116	156
T15047	1297 303 135	39	T15366	0737 502 092	120	T15760	0750 119 109	156
T15053	1297 202 053	130	T15377	1295 304 248	226	T15760	0735 470 163	156
T15053	1297 202 013	130	T15383	1297 304 187	226	T15760	0735 470 074	156
T15053	1297 202 038	130	T15388	1269 304 017	279	T15771	0631 329 017	88
T15053	1297 302 173	130	T15393	1246 304 136	253	T15775	0631 329 050	89
T15053	1297 302 231	130	T15397	1272 304 124	248	T15861	1250 207 172	300
T15059	1268 304 424	269	T15397	1250 304 124	248	T15866	1268 308 012	79
T15065	1268 304 494	276	T15438	1250 304 305	45	T15872	1268 312 102	135
T15065	1268 304 491	276	T15444	1268 302 095	121	T15875	1269 307 574	95
T15072	1268 304 525	274	T15446	1250 303 084	30	T15875	1250 307 373	95
T15072	1310 304 096	274	T15452	1250 303 094	48	T15880	1268 306 035	95
T15078	1297 304 484	272	T15481	1250 303 137	48	T15887	1269 307 629	87
T15078	1297 304 402	272	T15484	1250 304 400	44	T15890	1240 307 338	136
T15078	1297 304 433	272	T15488	1268 303 094	47	T15918	(KIT-R9)	85
T15078	1297 304 505	272	T15531	1205 308 016	218	T15919	(KIT-S9)	85
T15084	1296 333 045	274	T15532	1205 308 020	218	T15920	0730 101 784	296
T15084	1296 333 044	274	T15565	1250 302 263	80	T15921	0730 102 988	297
T15084	1296 333 033	274	T15567	1297 302 012	80	T15922	4415 301 174	297
T15084	1296 333 022	274	T15569	1297 302 042	80	T15923	4415 301 416	85
T15084	1296 328 002	274	T15572	1269 302 269	81	T15924	4460 291 365	84
T15090	1312 304 106	245	T15572	1269 302 155	81	T15924	4460 291 336	84
T15096	1297 304 436	187	T15575	1272 304 166	271	T15926	4461 391 018	85
T15096	1268 304 510	187	T15575	1272 304 076*	271	T15926	4461 331 008	85
T15103	1312 304 056	242	T15575	1272 304 076	271	T15928	4461 391 005	297
T15119	1296 202 004	129	T15631	4415 201 155	84	T15929	4461 391 021	86
T15119	1296 302 033	129	T15631	4415 201 145	84	T15929	4461 391 029	86
T15151	1304 304 686	272	T15642	1308 304 064	20	T15929	4415 301 356	86
T15151	1304 304 134	272	T15648	1269 307 575	299	T15934	1297 233 056	243
T15151	1304 304 134*	272	T15708	1295 304 121	16	T15940	1316 233 015	245
T15151	1295 304 004	272	T15713	1295 304 136	36	T15940	1316 233 029	245
T15151	2074 315 037	272	T15719	1295 304 202	11	T16559	1250 307 572	136
T15198	1246 302 073	125	T15724	1297 304 269	15	T16564	1272 307 025	87
T15198	1246 302 054	125	T15724	1297 304 016	15	T16568	0730 260 330	58
T15202	1250 302 260	125	T15727	1297 304 266	21	T16577	1269 307 294	87
T15289	0730 301 356	189	T15727	1297 304 019	21	T16580	1269 307 297	299
T15289	0730 061 816	189	T15731	1295 304 127	21	T16608	1268 302 126	124
T15289	0501 398 753	189	T15736	1297 304 270	10	T16712	1296 312 042	211
T15346	1268 304 594	270	T15736	1297 304 153	10	T16712	1296 312 003	211
T15346	1268 304 445	270	T15739	1297 332 109	177	T16712	1296 312 016	211
T15353	(1307 204 244/HUB)	252	T15739	1297 332 005	177	T16723	1297 304 369	242
T15353	1308 304 066	252	T15745	0501 306 212	297	T16726	1297 304 371	245
T15353	1307 304 607	252	T15751	1297 303 075	78	T16799	1250 304 440	217
T15353	1307 304 168	252	T15751	1297 303 046	78	T16962	1240 306 244	199
T15359	1295 304 247	226	T15751	1297 303 054	78	T16962	1240 306 114	199



TAS no.	OEM no.	Pag.	TAS no.	OEM no.	Pag.	TAS no.	OEM no.	Pag.
T17222	1312 304 159	212	T17873	1316 304 150	275	T18524	0501 314 060	163
T17222	1268 304 476	212	T17873	1316 304 173/M	275	T18524	0501 320 435	163
T17603	1315 202 022	133	T17886	1312 304 052	258	T18524	0750 101 179	163
T17603	1315 302 043	133	T17886	0091 304 361	258	T18530	0630 502 027	205
T17603	1315 302 086	133	T17892	1296 334 004	214	T18533	1354 302 019	175
T17608	1315 304 131	139	T17901	1297 306 120	213	T18533	1312 202 017	175
T17608	1315 304 084	139	T17909	1316 202 025	134	T18533	1312 302 095	175
T17692	1315 202 037	132	T17909	1316 302 085	134	T18533	1315 302 196	175
T17692	1315 302 153	132	T17909	1316 302 226	134	T18554	1315 302 008	65
T17692	1315 302 214	132	T17909	1356 302 100	134	T18559	1315 303 064	70
T17692	1355 302 002	132	T17914	1316 304 103	34	T18559	1315 303 051	70
T17696	1315 304 089	34	T18028	1297 304 485	275	T18563	1315 304 018	93
T17790	1315 302 173	65	T18028	1297 304 401	275	T18571	0095 353 232	84
T17794	1315 303 046	40	T18028	1297 304 373	275	T18571	4472 353 098	84
T17794	1315 303 011	40	T18035	1313 304 009	246	T18571	4472 353 463	84
T17800	1315 303 052	71	T18042	1296 333 050	244	T18571	4472 353 600	84
T17800	1315 303 012	71	T18042	1316 333 009	244	T18576	4472 353 158	225
T17807	1315 304 017	33	T18047	1312 304 158	260	T18576	4472 353 157	225
T17825	1316 304 130	143	T18047	1312 304 181	260	T18581	1295 307 274	299
T17825	1312 304 153	143	T18052	1313 333 001	260	T18589	1269 298 939	122
T17825	1312 304 134	143	T18062	1315 304 027	22	T18589	1269 298 904	122
T17834	1315 304 130	143	T18264	1315 304 028	21	T18589	1269 298 944	122
T17834	1313 304 072	143	T18269	1315 304 029	144	T18589	1269 302 089	122
T17839	1356 304 035	139	T18287	1313 304 008	260	T18589	1269 302 168	122
T17839	1316 304 132	139	T18313	1297 304 442	16	T18614	1290 204 073	267
T17839	1316 304 079	139	T18313	1297 304 017	16	T18625	1312 298 911	262
T17866	1316 304 156	246	T18313	1297 304 263	16	T18625	1312 204 035	262
T17866	1316 304 146	246	T18326	1297 304 150	11	T18625	1312 204 037	262
T17866	1356 304 026/M	246	T18328	1297 304 261	22	T18625	1312 204 043	262
T17867	1316 304 159	241	T18328	1297 304 020	22	T18625	1315 204 006	262
T17867	1316 304 145	241	T18339	1297 303 140	77	T18637	1317 204 056	263
T17868	1316 304 162	258	T18339	0091 302 176	77	T18726	1238 304 345	140
T17868	1316 304 147	258	T18339	1297 303 045	77	T18726	1238 304 007	140
T17869	1316 304 163	261	T18339	1297 303 053	77	T18748	1295 334 075	210
T17869	1316 304 148	261	T18339	1297 303 064	77	T18748	1296 334 026	210
T17870	1316 304 167	283	T18353	1297 304 181	143	T18748	0750 132 027	210
T17870	1315 304 135	283	T18353	1297 304 030	143	T18748	1296 334 046	210
T17870	1297 304 515	283	T18371	1307 304 669	284	T18748	1296 334 003	210
T17870	0769 186 281	283	T18371	1307 304 371	284	T18807	4472 353 419	85
T17871	1316 304 168	267	T18371	1307 304 190	284	T18869	1295 307 479	79
T17871	1297 304 507	267	T18437	1269 298 938	121	T18869	0091 307 500	79
T17871	1316 304 149	267	T18437	1269 302 230	121	T18889	1297 304 441	12
T17872	1316 304 169	286	T18443	1268 302 132	122	T18889	1297 304 152	12
T17872	1316 304 078	286	T18443	1268 302 015	122	T18889	1297 304 262	12
T17872	1315 304 136	286	T18457	1268 302 049	124	T19041	1316 303 040	27
T17872	1310 304 067	286	T18461	1312 304 124	93	T19041	1316 303 005	27
T17872	1310 304 063	286	T18466	1315 303 050	40	T19046	1316 303 033	77
T17873	1316 304 170	275	T18524	0501 325 930	163	T19051	1316 303 071	69





TAS no.	OEM no.	Pag.	TAS no.	OEM no.	Pag.	TAS no.	OEM no.	Pag.
T19051	1316 303 064	69	T19401	1316 304 010	11	T19795	1304 304 062	283
T19056	1316 303 065	39	T19407	1316 304 235	195	T19816	1304 332 089	284
T19056	1316 303 003	39	T19407	1316 304 012	195	T19824	1304 333 005	267
T19061	1316 304 008	22	T19427	1315 298 002	172	T19832	1304 333 011	286
T19074	1297 304 179	143	T19433	1315 298 003	172	T19907	0630 531 055	207
T19096	1295 202 019	133	T19441	1315 298 001	117	T19914	0750 116 233	52
T19096	1295 202 001	133	T19448	1295 302 070	64	T19914	0635 331 390	52
T19096	1295 302 129	133	T19455	1295 303 028	39	T19927	1295 338 083	57
T19111	1295 304 236	36	T19464	1295 303 067	78	T19927	1295 338 012	57
T19116	1295 307 243	176	T19464	1295 303 054	78	T19952	1297 303 098	70
T19116	0731 208 033	176	T19476	1297 304 113	15	T19952	1297 303 051	70
T19135	1296 304 119	142	T19481	1297 304 128	31	T19961	1297 232 039	179
T19140	1316 302 066	63	T19483	1297 304 318	35	T19961	1297 232 027	179
T19145	1316 303 056	70	T19483	1297 304 175	35	T19961	0091 232 022	179
T19145	1316 303 070	70	T19492	1316 303 036	210	T19961	0091 232 013	179
T19150	1316 303 058	27	T19492	1316 203 001	210	T19971	1297 303 086	71
T19155	1316 303 063	40	T19500	1295 302 122	63	T19971	1297 303 043	71
T19160	1316 304 002	16	T19500	1295 302 168	63	T19975	1297 303 132	27
T19166	1316 304 094	22	T19506	1295 303 060	70	T19975	1297 303 042	27
T19174	1315 302 158	63	T19506	1295 303 092	70	T19975	1297 303 085	27
T19178	1315 303 004	28	T19521	1297 302 241	61	T19986	1295 303 025	29
T19184	1315 304 025	16	T19521	1297 302 079	61	T19997	1312 304 150	174
T19190	1315 304 132	60	T19526	1297 303 123	39	T19997	1312 304 097	174
T19190	1313 304 036	60	T19526	1297 303 041	39	T20005	1313 302 036	66
T19201	1316 306 015	214	T19530	1297 304 413	36	T20005	1313 302 001	66
T19201	1315 312 017	214	T19530	1297 304 285	36	T20010	1313 303 003	41
T19232	1268 304 237	32	T19530	1297 304 123	36	T20016	1313 303 004	71
T19236	1268 304 262	43	T19536	1315 304 004	11	T20022	1313 304 005	33
T19280	1292 305 004	191	T19542	1315 304 380	195	T20028	1313 304 038	59
T19280	1292 305 002	191	T19542	1315 304 006	195	T20038	1250 304 441	279
T19288	1297 303 077	26	T19548	1316 303 004	41	T20043	1297 332 017	182
T19288	1297 303 021	26	T19727	1304 302 425	236	T20132	1314 202 039	162
T19288	1297 303 022	26	T19727	1304 302 259	236	T20132	1315 202 018	162
T19293	1297 304 151	10	T19735	1304 304 664	281	T20138	1315 302 120	162
T19311	0730 062 579	189	T19735	1311 304 011	281	T20138	1315 302 116	162
T19318	1240 307 346	300	T19735	1311 304 103	281	T20143	1315 302 121	161
T19318	1240 307 226	300	T19748	1311 304 255	271	T20143	1315 302 117	161
T19318	0091 307 303	300	T19748	1311 304 010	271	T20148	1315 303 027	162
T19341	1499 298 003	222	T19748	1311 304 076	271	T20190	1269 298 933	115
T19347	0730 105 156	221	T19778	1304 233 006	247	T20190	1269 298 932	115
T19360	1295 304 206	94	T19778	1304 233 011	247	T20194	1295 298 915	115
T19368	1297 304 154	94	T19778	1324 233 006	247	T20194	1295 698 191	115
T19375	1316 233 010	191	T19786	1304 304 408	240	T20194	0091 298 010	115
T19379	1316 302 057	66	T19786	1304 304 076	240	T20194	0090 298 191	115
T19384	1316 302 065	65	T19795	1311 304 177	283	T20200	1295 298 960	112
T19388	1316 302 067	66	T19795	1311 304 102	283	T20200	1295 298 917	112
T19393	1316 303 006	28	T19795	1304 304 597	283	T20221	1268 298 903	173
T19397	1316 304 007	33	T19795	1304 304 541	283	T20227	1315 202 040	132



TAS no.	OEM no.	Pag.	TAS no.	OEM no.	Pag.	TAS no.	OEM no.	Pag.
T20227	1315 302 162	132	T20581	1316 232 019	181	T20945	1316 333 034	285
T20227	1315 302 217	132	T20643	1312 304 084	58	T20946	1324 304 014	174
T20227	1355 302 005	132	T20680	1315 303 042	76	T20963	0750 119 124	57
T20230	1315 232 010	185	T20689	1296 333 046	91	T20968	0750 119 125	57
T20235	1315 232 017	181	T20689	1296 333 039	91	T21000	0501 321 065	102
T20235	1315 232 016	181	T20699	0501 314 108	171	T21001	0501 322 828	101
T20235	1315 232 013	181	T20703	0630 502 063	205	T21002	0501 322 829	101
T20249	1315 332 032	183	T20709	1304 302 440	174	T21003	0501 324 626	100
T20250	1315 332 041	197	T20709	1304 302 364	174	T21004	0734 310 104	168
T20250	1316 332 054	197	T20710	1324 302 029	132	T21011	0750 112 047	165
T20259	1315 332 053	178	T20710	1324 202 014	132	T21022	1290 301 140	101
T20259	1315 332 044	178	T20711	1324 204 009	237	T21022	1290 301 073	101
T20268	1316 332 130	181	T20713	1324 304 003	32	T21037	1304 301 305	99
T20268	1316 332 103	181	T20714	1324 304 005	141	T21040	1324 307 082	98
T20293	1238 317 058	213	T20715	1324 304 006	255	T21041	1268 307 170	101
T20305	1250 302 258	122	T20716	1324 304 011	236	T21041	1268 307 091	101
T20359	1269 304 130	24	T20717	1324 304 015	14	T21066	4139 333 794	210
T20359	1269 304 022	24	T20762	0734 319 459	164	T21066	4139 333 755	210
T20365	1269 305 005	192	T20768	0750 111 341	164	T21067	0634 300 185	164
T20365	1269 305 004	192	T20768	0734 300 095	164	T21067	0501 398 018	164
T20408	1268 298 904	115	T20768	0734 300 102	164	T21080	0634 300 302	165
T20435	1269 304 016	254	T20768	0734 310 116	164	T21080	0734 300 196	165
T20443	1269 304 071	254	T20768	0734 319 253	164	T21095	0634 307 367	166
T20451	1269 328 229	221	T20788	5841 300 586	90	T21107	0634 316 057	158
T20471	1316 202 026	134	T20790	5841 302 094	121	T21107	0634 314 021	158
T20471	1316 302 014	134	T20829	0734 307 294	163	T21126	0734 310 108	167
T20471	1316 302 079	134	T20829	0734 307 280	163	T21138	0750 110 074	172
T20471	1316 302 103	134	T20838	0768 800 253	170	T21138	0634 300 712	172
T20471	1316 302 221	134	T20838	0734 310 387	170	T21138	0734 300 093	172
T20474	1316 232 011	185	T20838	0734 310 386	170	T21159	0750 111 004	171
T20480	1316 303 031	71	T20838	0734 310 111	170	T21159	0734 310 109	171
T20484	1316 303 034	77	T20838	0730 162 753	170	T21176	1238 308 201	97
T20488	1316 304 003	15	T20859	0750 112 253	166	T21176	1238 308 032	97
T20492	1316 304 009	21	T20859	0750 112 131	166	T21176	1238 308 166	97
T20496	1316 304 013	10	T20859	0501 324 292	166	T21176	1238 309 163	97
T20500	1316 332 031	184	T20859	0501 312 845	166	T21194	1250 302 298	104
T20505	1315 302 157	63	T20859	0501 312 712	166	T21194	1250 302 373	104
T20510	1315 303 008	72	T20866	1324 233 001	245	T21194	1250 302 478	104
T20515	1315 303 010	28	T20866	1324 333 019	245	T21217	1250 306 282	105
T20520	1315 304 013	195	T20867	1324 304 013	239	T21217	1250 306 182	105
T20525	1316 303 030	72	T20895	0091 304 310	242	T21235	1250 307 680	105
T20530	1316 303 055	72	T20895	1316 304 186-OLD	242	T21239	1250 307 686	105
T20535	1316 304 015	194	T20899	0091 304 311	242	T21239	1250 307 521	105
T20539	1316 304 133	56	T20899	0091 304 109	242	T21249	1250 312 473	105
T20539	1312 304 082	56	T20899	1316 304 187	242	T21249	1250 312 222	105
T20551	1316 332 096	178	T20913	1315 303 063	77	T21261	1252 307 068	105
T20551	1316 332 038	178	T20919	1315 305 011	193	T21261	1252 307 060	105
T20580	(1313 232 003/G)	184	T20919	1315 305 002	193	T21282	1268 303 132	106



TAS no.	OEM no.	Pag.	TAS no.	OEM no.	Pag.	TAS no.	OEM no.	Pag.
T21282	1268 303 071	106	T21558	1313 307 006	109	T21769	0501 309 420	165
T21297	1268 307 169	106	T21558	1295 307 423	109	T21769	0501 309 421	165
T21297	1203 307 289	106	T21562	1313 307 022	110	T21769	0501 398 042	165
T21310	1268 308 020	106	T21562	1296 307 046	110	T21786	0750 112 066	164
T21310	1268 308 003	106	T21566	1313 307 020	110	T21786	0501 307 769	164
T21326	1269 331 078	106	T21566	1295 307 054	110	T21798	0750 112 089	169
T21326	1269 331 036	106	T21566	1313 307 001	110	T21798	0634 307 825	169
T21338	1269 331 077	106	T21583	0501 310 614	110	T21798	0734 317 025	169
T21338	1269 331 035	106	T21588	0634 300 020	165	T21814	0501 314 246	110
T21350	1269 307 645	107	T21597	0634 313 671	159	T21814	0750 112 138	110
T21350	1269 307 514	107	T21606	0634 314 015	159	T21814	0750 112 153	110
T21357	1269 307 650	107	T21606	0634 313 052	159	T21819	0501 314 587	103
T21361	1269 307 644	107	T21618	0634 314 017	158	T21827	0501 316 146	103
T21361	1269 307 299	107	T21618	0634 304 327	158	T21827	0501 314 808	103
T21374	1269 307 643	107	T21628	0634 314 018	158	T21838	0501 324 072	110
T21374	1269 307 200	107	T21636	0634 314 019	160	T21838	0501 317 240	110
T21386	1269 307 642	107	T21636	0634 313 734	160	T21838	1315 307 267	110
T21386	1269 307 026	107	T21645	0634 316 174	160	T21843	1304 307 177	111
T21398	1269 302 305	108	T21645	0634 314 020	160	T21843	1304 307 013	111
T21398	1269 302 161	108	T21657	0634 314 022	159	T21843	0501 318 308	111
T21413	1269 302 303	108	T21657	0634 313 053	159	T21861	1315 301 007	102
T21413	1269 302 163	108	T21662	0634 801 013	200	T21867	1315 301 233	104
T21416	1250 319 040	108	T21667	0634 801 028	201	T21867	1315 301 005	104
T21416	1250 319 035	108	T21667	0634 801 216	201	T21879	1315 301 234	100
T21421	1250 302 485	108	T21668	0634 801 050	202	T21879	0501 313 513	100
T21421	1250 302 301	108	T21668	0634 801 045	202	T21879	1315 301 034	100
T21429	1269 338 110	221	T21677	0634 801 062	202	T21891	1315 303 060	104
T21429	0501 315 085	221	T21685	0634 801 074	202	T21891	0501 314 747	104
T21441	1313 301 036	100	T21685	5838 300 094	202	T21903	1315 307 012	104
T21441	1269 301 007	100	T21693	0634 801 205	201	T21909	1315 307 013	97
T21441	1296 301 007	100	T21693	0634 801 164	201	T21916	1315 307 242	100
T21453	1313 301 037	102	T21693	0634 801 214	201	T21922	1315 331 001	104
T21453	1296 301 005	102	T21705	0634 801 246	201	T21922	0750 112 136	104
T21467	1313 301 038	102	T21705	0634 801 027	201	T21934	1316 301 022	111
T21467	1296 301 004	102	T21715	0634 801 250	204	T21939	1316 301 042	103
T21467	1296 301 189	102	T21718	0634 801 260	201	T21945	0750 111 575	166
T21480	1313 302 014	102	T21718	0634 801 038	201	T21945	0501 312 738	166
T21480	1297 302 022	102	T21722	0634 801 324	203	T21955	0634 313 375	157
T21494	1313 306 012	108	T21722	0634 801 156	203	T21955	0501 317 536	157
T21494	1295 306 041	108	T21735	0730 008 637	203	T21967	0634 312 523	165
T21508	1313 307 002	109	T21735	0634 801 236	203	T21971	0634 313 018	159
T21508	1295 307 162	109	T21748	0750 112 019	157	T21981	0634 313 198	158
T21520	1313 307 003	109	T21748	0734 317 150	157	T21994	0634 313 320	159
T21520	1295 307 076	109	T21748	0734 317 032	157	T22001	0634 313 505	158
T21534	1313 307 004	109	T21759	0750 111 002	168	T22007	0634 313 805	160
T21534	1295 307 053	109	T21759	0734 310 110	168	T22012	0634 801 097	204
T21547	1313 307 005	109	T21769	0750 112 034	165	T22020	0634 801 206	203
T21547	1295 307 392	109	T21769	0501 306 439	165	T22026	0634 801 219	202



TAS no.	OEM no.	Pag.	TAS no.	OEM no.	Pag.	TAS no.	OEM no.	Pag.
T22026	0634 801 051	202	T22208	0750 117 678	295	T22222	0750 117 844	291
T22026	0730 008 604	202	T22208	568742A	295	T22222	0735 371 599	291
T22033	0634 801 249	203	T22208	0750 117 402	295	T22222	0735 370 470	291
T22036	0634 801 321	204	T22210	5841 300 574	295	T22223	1324 304 070	56
T22042	0730 008 055	200	T22210	VKHB 2232	295	T22223	1324 304 064	56
T22049	0730 008 057	201	T22210	SET 1116	295	T22223	1304 304 050	56
T22053	0730 009 515	203	T22211	1324 304 021	194	T22231	1304 304 543	137
T22053	0634 801 073	203	T22211	1304 304 553	194	T22235	1324 304 028	227
T22059	0750 112 177	169	T22212	0735 371 096	289	T22235	1324 304 012	227
T22059	0750 112 117	169	T22212	SET 238	289	T22236	1324 304 030	9
T22075	1316 245 012/KIT	96	T22212	0750 117 881	289	T22236	1324 304 001	9
T22077	1316 245 013/KIT	96	T22214	0750 117 732	295	T22240	1324 304 037	254
T22079	1315 245 016/KIT	96	T22214	F-803621	295	T22240	1304 304 443	254
T22091	1315 245 017/KIT	96	T22214	30217	295	T22268	1316 245 013	95
T22103	1307 204 230	258	T22214	VKHB 2334	295	T22268	0501 209 448	95
T22111	1307 295 235	44	T22214	VKT 8490	295	T22268	0501 211 400	95
T22111	1307 204 323	44	T22215	0750 117 518	294	T22271	0634 801 217	202
T22111	1307 204 279	44	T22215	K47490-47420	294	T22275	1316 304 189	273
T22111	1307 204 170	44	T22215	SET 928	294	T22275	1316 304 196/M	273
T22111	1307 204 043	44	T22215	0735 370 297	294	T22279	1316 304 190	241
T22117	1307 304 626	243	T22216	0735 371 563	290	T22279	1316 304 201	241
T22117	1307 304 451	243	T22216	K4369	290	T22279	1356 304 025/M	241
T22117	1307 395 089	243	T22216	VKT 8956	290	T22280	1356 304 019	258
T22124	1307 304 628	228	T22216	0735 371 232	290	T22281	1356 304 022	250
T22124	1307 395 088	228	T22216	0750 117 232	290	T22282	1356 304 023	283
T22131	1307 304 643	273	T22217	0750 117 083	292	T22282	1316 304 188	283
T22131	1308 304 097	273	T22217	SET 271	292	T22283	1356 304 024	276
T22131	1307 304 588	273	T22217	0635 501 357	292	T22284	1356 304 025	240
T22131	1308 304 095	273	T22217	0635 501 400	292	T22284	1316 304 218	240
T22131	1307 304 262	273	T22217	0735 300 512	292	T22285	1356 304 026	243
T22149	1307 304 644	268	T22218	0750 117 011	292	T22293	1316 304 154	231
T22149	1306 304 085	268	T22218	VKT 8955	292	T22294	1316 304 183	244
T22149	1307 304 589	268	T22218	SET 1127	292	T22295	1316 304 185	241
T22169	1307 395 316	72	T22218	0735 370 059	292	T22301	1324 232 002	184
T22169	1307 303 122	72	T22219	0750 117 009	291	T22302	1324 303 001	75
T22169	1307 303 014	72	T22219	F-809306	291	T22303	1324 303 003	40
T22175	1290 304 482	231	T22219	SET 1133	291	T22304	1324 303 004	70
T22175	1290 304 505	231	T22219	0735 371 604	291	T22305	1324 303 017	13
T22183	1290 304 508	240	T22219	0735 372 156	291	T22305	1324 303 015	13
T22188	1290 304 509	229	T22220	0750 116 394	53	T22306	1324 305 001	192
T22193	1290 304 620	144	T22220	539244B	53	T22307	1324 332 001	184
T22196	1317 304 149	272	T22220	0635 304 904	53	T22308	1324 332 016	179
T22196	1317 304 114	272	T22220	0735 330 043	53	T22308	1324 332 012	179
T22207	0750 117 883	292	T22220	0750 116 002	53	T22309	1324 332 018	197
T22207	0750 117 030	292	T22221	0735 371 748	288	T22309	1324 332 002	197
T22207	0750 117 010	292	T22221	JXC 25662 C	288	T22310	(1324/GASKET M1)	287
T22207	0735 501 011	292	T22221	0750 117 080	288	T22315	6007 202 079/KIT	96
T22207	0735 370 058	292	T22221	0750 117 507	288	T22317	1324 304 052	248



TAS no.	OEM no.	Pag.	TAS no.	OEM no.	Pag.	TAS no.	OEM no.	Pag.
T22317	1304 304 591	248	T22689	1290 304 515	49	T23699	1307 204 307	12
T22325	1324 304 053	282	T22693	1290 304 572	9	T23710	1307 304 632	15
T22326	1324 332 007	181	T22696	1290 304 573	93	T23710	1307 204 273	15
T22335	0750 118 198	83	T22699	1346 304 118	255	T23710	1307 204 304	15
T22335	F-211413.02	83	T22699	1290 304 586	255	T23721	1307 304 640	20
T22335	VKT 8906	83	T22704	1290 304 618	257	T23721	1307 204 343	20
T22335	0735 410 319	83	T22704	1317 304 031	257	T23726	1317 303 015	45
T22335	0735 410 327	83	T22704	1290 304 619	257	T23726	1307 395 322	45
T22336	1307 202 116	292	T22704	1317 304 169	257	T23732	1307 304 638	20
T22336	1307 202 018	292	T22880	1290 306 066	216	T23732	1307 204 316	20
T22337	0750 116 373	52	T22894	1290 306 423	216	T23740	1307 204 325	43
T22337	BB1 3167	52	T22898	1290 306 439	215	T23740	1307 204 173	43
T22337	0735 330 615	52	T22902	1304 306 107	215	T23740	1307 204 277	43
T22338	0735 371 607	289	T23272	0635 373 021	290	T23740	1307 204 158	43
T22338	0750 117 110	289	T23272	VKHB 2015	290	T23748	1307 303 104	78
T22338	0750 117 199	289	T23272	SET 1058	290	T23752	1317 303 016	49
T22338	1290 203 018	289	T23272	0635 373 004	290	T23755	1307 304 671	284
T22522	1290 203 039	73	T23272	0735 370 282	290	T23755	1307 304 544	284
T22522	1290 203 043	73	T23281	0730 000 286	302	T23763	1307 304 650	195
T22522	1290 303 192	73	T23286	0750 120 098	289	T23763	1307 204 268	195
T22530	1290 303 198	38	T23286	HDB070	289	T23763	1307 204 291	195
T22535	1290 304 056	58	T23286	VKHB 2182	289	T23763	1307 204 309	195
T22544	1290 304 058	193	T23286	SET 1107	289	T23772	1307 303 123	72
T22544	1290 304 371	193	T23287	1269 338 103	58	T23772	1307 303 060	72
T22558	1290 304 574	31	T23294	1304 242 006	210	T23778	1307 304 649	195
T22558	1290 304 546	31	T23296	0636 604 496	199	T23778	1307 204 292	195
T22558	1290 304 480	31	T23305	0730 105 493	302	T23778	1307 204 310	195
T22562	1290 305 034	191	T23305	0630 003 009	302	T23789	1307 395 318	29
T22562	1290 305 031	191	T23305	0630 305 502	302	T23789	1317 303 012	29
T22562	1290 305 029	191	T23305	6001 302 082	302	T23789	1307 303 110	29
T22562	1290 305 026	191	T23323	0737 300 035	157	T23794	1307 305 025	193
T22562	1290 305 025	191	T23323	0737 006 005	157	T23798	1307 303 116	29
T22587	0735 370 438	289	T23323	0737 006 061	157	T23798	1307 303 059	29
T22587	0750 117 198	289	T23634	6090 301 009	97	T23800	1307 305 026	193
T22587	1290 203 017	289	T23645	1324 232 004	180	T23800	1307 305 014	193
T22601	1290 303 197	25	T23668	1290 304 581	19	T23803	0735 371 406	288
T22605	1290 303 199	51	T23668	1290 304 510	19	T23803	BT1B 329154/Q/CL7C	288
T22610	1290 303 200	71	T23668	1290 304 477	19	T23803	VKT 8957	288
T22659	0750 117 079	294	T23670	1307 304 633	17	T23809	1307 203 019	288
T22659	0735 370 233	294	T23670	1307 204 271	17	T23809	1307 203 009	288
T22670	0735 371 749	289	T23670	1307 204 303	17	T23809	1307 203 010	288
T22670	VKHB 2065	289	T23677	1307 304 623	144	T23878	0750 117 081	291
T22670	SET 1108	289	T23677	1317 304 066	144	T23878	0735 371 605	291
T22670	0635 376 023	289	T23690	1307 304 653	11	T23885	0750 117 640	293
T22670	0735 300 509	289	T23690	1307 204 306	11	T23885	VKHB 2023	293
T22686	1290 302 507	129	T23690	1307 204 270	11	T23885	SET 315	293
T22686	1290 302 482	129	T23699	1307 304 652	12	T23890	0750 118 131	84
T22689	1290 304 547	49	T23699	1307 204 274	12	T23890	566616 B	84



TAS no.	OEM no.	Pag.	TAS no.	OEM no.	Pag.	TAS no.	OEM no.	Pag.
T23890	BC1B 319552	84	T37822	0631 329 052	89	T38138	0750 117 057	292
T23890	0735 410 051	84	T37822	0631 329 051	89	T38138	31310A	292
T23890	0735 410 238	84	T37830	0631 329 167	88	T38138	0635 900 363	292
T37620	0735 295 119	60	T37830	0631 329 018	88	T38142	0750 117 677	295
T37620	0730 161 354	60	T37860	0734 319 439	172	T38142	575194	295
T37633	1304 304 444	280	T37860	0734 319 283	172	T38142	0750 117 403	295
T37642	1317 304 168	255	T37860	0750 111 081	172	T38154	0750 118 153	82
T37642	1317 304 026	255	T37860	0750 111 317	172	T38154	540106	82
T37644	0750 117 562	288	T37877	0734 319 559	170	T38154	635245	82
T37644	0735 371 591	288	T37877	0634 300 128	170	T38154	0501 398 348	82
T37644	JXC 25665 CC	288	T37877	0734 310 142	170	T38154	0501 398 349	82
T37644	0735 371 375	288	T37877	0750 111 040	170	T38173	1290 204 091	261
T37644	0735 370 987	288	T37898	0734 319 652	168	T38173	1290 204 072	261
T37663	1307 303 107	79	T37903	1327 298 001	112	T38270	0091 298 001	112
T37664	1307 202 168	131	T37914	0735 371 268	291	T38271	1304 302 188	236
T37664	1307 202 166	131	T37914	VKHB 2272	291	T38271	1304 302 006	236
T37665	1307 202 169	134	T37914	SET 318	291	T38279	1304 304 012	235
T37665	1307 202 167	134	T37946	1310 302 023	236	T38285	1304 304 680	270
T37666	0501 316 322	98	T37950	1310 304 091	42	T38285	1304 304 496	270
T37680	0634 316 523	157	T37954	1310 304 157	259	T38285	1304 304 132	270
T37686	0634 801 308	200	T37959	1311 304 009	235	T38313	1304 304 683	270
T37694	0734 319 847	169	T37967	1311 304 226	255	T38320	1304 304 688	281
T37694	0750 111 348	169	T37974	1311 304 248	141	T38320	6002 304 852	281
T37714	6002 305 661	271	T37974	1311 304 225	141	T38320	6002 305 511	281
T37714	6002 304 493	271	T37993	0750 118 220	83	T38332	1315 202 039	132
T37714	1290 304 473	271	T37993	F 88816.2	83	T38332	1315 302 163	132
T37714	1238 304 420	271	T37993	0735 455 248	83	T38334	1316 202 037	132
T37714	1238 304 389	271	T37993	0750 118 030	83	T38334	1316 302 087	132
T37729	1328 302 064	248	T38006	0750 118 005	83	T38433	1310 302 001	126
T37740	1328 302 132	266	T38006	F 90836.1A	83	T38437	1310 303 032	73
T37740	1328 302 015	266	T38006	0735 455 062	83	T38441	1310 303 033	50
T37740	1328 302 109	266	T38006	0735 455 101	83	T38445	1310 303 051	38
T37749	0635 470 046	186	T38006	0735 455 114	83	T38449	1310 304 080	258
T37750	0734 310 396	166	T38014	0750 118 038	82	T38458	1310 304 112	24
T37750	0734 310 253	166	T38014	F 88545	82	T38458	1310 304 085	24
T37763	0750 111 469	171	T38014	0735 455 040	82	T38463	1310 304 088	33
T37763	0734 319 047	171	T38014	0750 118 008	82	T38486	1315 334 069	211
T37763	0750 111 268	171	T38025	0750 118 010	81	T38486	1315 334 056	211
T37785	0750 117 778	290	T38025	87486	81	T38519	1316 304 196	276
T37785	0750 117 524	290	T38025	0735 455 018	81	T38521	1316 304 173	276
T37785	0635 374 019	290	T38025	0735 455 023	81	T38530	1316 301 053	97
T37785	VKHB 2004	290	T38034	0750 118 082	83	T38530	1315 301 095	97
T37785	SET 1078	290	T38034	0750 118 077	83	T38530	1315 301 094	97
T37803	0750 117 008	293	T38047	0750 118 258	83	T38575	0734 319 687	171
T37803	32310A	293	T38047	F-211408.05	83	T38575	0734 319 440	171
T37803	VKHB 2070	293	T38047	0750 118 191	83	T38575	0750 111 334	171
T37803	VKHB 2401 S	293	T38058	0750 116 231	52	T38576	0750 111 149	167
T37803	32310	293	T38058	6209NC3	52	T38576	0734 310 161	167



TAS no.	OEM no.	Pag.	TAS no.	OEM no.	Pag.	TAS no.	OEM no.	Pag.
T38660	0750 111 476	166	T38931	1290 304 417	281	T39112	0630 501 175	205
T38660	0734 310 112	166	T38931	1290 395 193	281	T39113	0630 531 064	206
T38660	0734 310 304	166	T38983	1310 303 031	26	T39290	0734 300 087	167
T38660	0750 111 269	166	T38987	1499 298 023	222	T39290	0634 300 543	167
T38681	0734 307 287	168	T38988	1499 298 025	222	T39312	0750 190 014	163
T38688	0734 310 397	167	T38989	1499 298 027	223	T39312	0750 112 239	163
T38701	1316 305 008	193	T39036	0730 062 781	189	T39312	0501 316 778	163
T38701	1316 305 001	193	T39058	1290 304 438	269	T39312	0501 314 772	163
T38706	1316 304 179	259	T39058	1290 304 356	269	T39312	0501 311 036	163
T38706	1316 304 152	259	T39059	1290 304 350	268	T39343	0091 304 314	34
T38710	1290 301 146	99	T39060	1290 304 366	268	T39343	0091 304 193	34
T38710	1290 301 035	99	T39060	6002 306 154	268	T39344	0091 302 294	67
T38719	1290 301 145	97	T39075	1346 304 025	252	T39674	0501 209 188	54
T38719	1290 301 030	97	T39076	1346 304 093	237	T41353	1329 302 002	68
T38731	0501 315 106	100	T39078	1346 298 004	264	T41357	1329 304 011	68
T38731	1290 312 167	100	T39078	1346 204 005	264	T41357	1329 304 002	68
T38731	1290 312 249	100	T39079	1307 202 150	134	T41363	1346 302 081	120
T38751	1307 298 930	113	T39079	1307 202 149	134	T41470	0501 321 146	188
T38751	1307 298 030	113	T39085	1499 298 026	223	T41517	TAS41517	303
T38786	1316 333 014	56	T39086	1499 298 024	222	T41561	1325 302 044	186
T38841	1297 198 400	187	T39087	1499 298 160	221	T41563	1325 334 008	214
T38854	0730 107 168	296	T39088	1499 298 156	222	T41595	0501 212 474	61
T38854	0730 102 412	296	T39089	0730 005 748	219	T41820	0091 304 369	24
T38862	0734 319 514	169	T39090	0730 005 749	219	T41955	6090 012 002	175
T38869	1346 304 047	235	T39091	0730 007 489	220	T41972	TAS41972	265
T38872	1346 304 038	267	T39092	0730 007 484	219	T43978	0631 329 147	89
T38873	1346 304 094	238	T39093	0730 007 136	219	T43979	0631 329 261	88
T38877	1310 304 195	282	T39094	0730 101 467	303	T43980	1316 232 039	180
T38877	1311 312 043	282	T39095	0730 106 910	303	T43981	1316 332 140	177
T38877	1311 298 012	282	T39096	0730 106 917	303	T43982	1315 232 027	180
T38877	1311 212 024	282	T39097	0730 106 905	302	T43983	1315 332 091	178
T38889	1325 333 018	285	T39098	0630 501 112	206	T43994	1307 204 293	265
T38890	1325 233 007	233	T39099	0630 501 116	206	T44643	1295 304 278/M	234
T38890	1325 333 017	233	T39100	0630 501 516	208	T44682	0091 303 142	38
T38899	1315 334 036	81	T39100	0630 501 316	208	T44682	0091 303 094	38
T38900	1315 312 048	211	T39101	0630 501 313	208	T44682	0091 303 138	38
T38900	1315 312 032	211	T39102	0630 501 334	208	T44688	0091 303 137	26
T38901	1316 312 015	211	T39103	1315 304 045	298	T44688	0091 303 093	26
T38901	1316 312 011	211	T39104	1315 304 047	298	T44693	0091 304 297	12
T38929	1290 304 474	272	T39104	1312 304 060	298	T44693	0091 304 190	12
T38929	1290 304 098	272	T39105	1315 304 048	299	T44698	1297 304 148	194
T38929	1290 304 472	272	T39106	1315 304 086	298	T44698	0091 304 367	194
T38929	1290 395 311	272	T39107	1315 304 046	298	T44698	0091 304 210	194
T38929	1290 395 332	272	T39108	0730 006 171	90	T45294	TAS45294	113
T38930	1304 304 623	233	T39109	0730 005 465	220	T45294	(9S1110/G & S KIT)	113
T38931	1238 304 390	281	T39110	0730 007 747	90	T45296	TAS45296	266
T38931	1238 304 357	281	T39110	0501 398 752	90	T45296	(9S1110/SYNCHRO KIT)	266
T38931	1290 304 083	281	T39111	0630 501 061	209	T45496	6038 202 003	301



TAS no.	OEM no.	Pag.	TAS no.	OEM no.	Pag.	TAS no.	OEM no.	Pag.
T45496	0501 204 063	301	T46739	0735 320 896	154	T46924	0735 320 111	155
T45496	0501 204 851	301	T46739	0750 115 959	154	T46924	0735 320 408	155
T45496	0750 132 001	301	T46759	0735 320 496	150	T46931	0750 115 283	152
T45496	0750 132 037	301	T46769	0735 320 786	154	T46931	K 80X88X46 ZW A	152
T45524	1295 307 160	54	T46769	0735 320 584	154	T46931	0735 320 471	152
T45524	0750 115 335	54	T46769	0501 398 351	154	T46931	0735 320 410	152
T45524	0501 204 318	54	T46784	1292 298 905	156	T46931	0735 320 206	152
T45553	0730 162 428	57	T46785	0735 320 465	149	T47385	0750 116 166	53
T45553	0730 161 689	57	T46785	722013010	149	T47385	61915-A	53
T45797	1307 395 124	231	T46785	F-58637	149	T47385	0635 338 048	53
T45797	1307 302 109	231	T46785	0735 300 149	149	T47385	0635 900 686	53
T45797	0091 302 208	231	T46794	0735 320 466	151	T47396	0635 373 008	293
T46524	1346 302 054	121	T46794	F-88416	151	T47396	32212A	293
T46525	1346 304 107	139	T46794	0735 300 150	151	T47396	VKHB 2347	293
T46557	1346 204 004	265	T46801	0735 320 499	148	T47396	VKT 8690	293
T46559	0091 302 160	62	T46801	K 62X70X40 ZW	148	T47396	SET 1061	293
T46563	0091 302 179	64	T46801	0735 320 161	148	T47446	0735 340 080	53
T46563	0091 302 272	64	T46801	0735 320 205	148	T47446	61814-Y-C3	53
T46568	0091 303 146	77	T46801	0750 115 007	148	T47477	0750 118 019	82
T46568	0091 303 104	77	T46816	0735 320 377	150	T47477	512533	82
T46573	0091 303 106	19	T46816	F-59437	150	T47477	F-87629	82
T46577	0091 303 141	35	T46834	0750 115 970	151	T47477	0735 455 004	82
T46577	0091 303 102	35	T46834	F-87588	151	T47477	0735 455 019	82
T46577	0091 303 143	35	T46834	0735 320 462	151	T47553	0635 330 050	53
T46586	0091 304 194	226	T46834	0735 320 551	151	T47553	16015.C3	53
T46590	0091 304 315	62	T46834	0735 320 374	151	T47553	0635 330 016	53
T46590	0091 304 219	62	T46847	0735 320 371	152	T47570	0635 370 030	287
T46662	1295 298 948	155	T46847	F-58242	152	T47570	32022X	287
T46664	0735 320 460	152	T46847	0735 320 483	152	T47570	VKHB 2281	287
T46670	0735 320 548	149	T46847	0735 320 484	152	T47570	SET 1052	287
T46676	0735 320 549	152	T46856	0735 320 396	148	T47570	0735 371 464	287
T46683	0735 320 799	153	T46856	F-58723	148	T49029	0735 300 495	294
T46683	0735 320 475	153	T46856	0735 320 261	148	T49029	SET 1034	294
T46683	0735 320 684	153	T46876	1268 298 950	156	T49178	0750 115 584	154
T46704	0735 320 451	153	T46878	0735 320 154	153	T49178	0735 321 087	154
T46704	F-553952	153	T46878	F-20339	153	T49199	0750 115 325	155
T46704	F-87934	153	T46888	0735 320 314	147	T49199	F-212875.01	155
T46712	0735 320 452	153	T46888	F-50908	147	T49209	0750 115 366	147
T46712	F-553954	153	T46888	0735 320 203	147	T49209	F-217112	147
T46712	F-84992	153	T46888	9999 888 662	147	T49360	1324 298 013	117
T46712	0750 115 021	153	T46897	0750 115 011	146	T49361	1324 298 014	116
T46712	0750 115 958	153	T46897	K 45X53X21 A	146	T49492	1304 298 914	117
T46721	0735 320 486	151	T46897	0735 320 042	146	T49492	1304 298 902	117
T46721	F-88404	151	T46897	0735 320 492	146	T50153	0091 202 028	135
T46721	0750 115 957	151	T46911	0735 320 407	151	T50153	0091 302 173	135
T46731	0735 320 487	153	T46911	0735 320 110	151	T50154	0091 304 128	228
T46731	F-88405	153	T46924	0750 115 282	155	T50155	0501 215 358	300
T46731	0750 115 956	153	T46924	K 95X103X40 ZW A	155	T50155	0501 207 444	300





TAS no.	OEM no.	Pag.	TAS no.	OEM no.	Pag.	TAS no.	OEM no.	Pag.
T50155	0501 208 629	300	T51474	0735 321 530	151	T53922	0735 320 871	148
T50155	0501 209 434	300	T51474	F-233439	151	T53929	0735 320 873	149
T50156	0501 215 359	300	T51474	0735 320 500	151	T53937	0735 321 010	146
T50156	0501 207 445	300	T51474	0750 115 009	151	T53975	1304 202 214	237
T50156	0501 208 630	300	T51474	0750 115 012	151	T53982	1311 304 015	228
T50156	0501 209 435	300	T51495	0735 358 192	146	T53982	1311 304 180	228
T50156	0501 219 310	300	T51495	0750 115 229	146	T54497	1268 298 889	116
T50157	1269 302 127	199	T51495	0750 115 974	146	T54497	0090 298 189	116
T50157	0635 470 012	199	T51522	0750 115 973	148	T54510	1304 202 208	131
T50158	0730 004 796	220	T51522	0750 115 225	148	T54510	1304 302 430	131
T50164	0735 298 169	145	T51662	6085 301 012	118	T54515	1295 338 061	91
T50165	0735 320 816	150	T51899	1324 298 001	117	T54521	1304 232 085	190
T50165	0750 115 971	150	T51899	TAS51899	117	T54521	1304 232 083	190
T50166	0750 115 299	147	T52341	0750 101 158	302	T54539	6093 204 010	190
T50167	0750 115 369	147	T52347	0750 112 096	197	T54539	6093 204 001	190
T50168	0750 115 534	84	T52620	1307 204 275	290	T54539	6093 204 007	190
T50168	0750 115 531	84	T52620	1307 204 056	290	T54540	1328 333 005	270
T50168	0735 358 313	84	T52771	0091 304 266	138	T54540	1328 333 001	270
T50169	0750 115 969	148	T52771	0091 304 208	138	T54542	1328 306 026	95
T50169	0735 321 563	148	T53081	0730 109 323	296	T54546	1328 202 046	269
T50169	0735 302 221	148	T53087	0730 109 309	296	T54546	1328 202 042	269
T50171	1297 332 120	182	T53391	0091 302 276	67	T54546	1328 302 011	269
T50173	1304 202 245	126	T53398	0091 304 317	18	T54546	1328 302 084	269
T50173	1304 302 473	126	T53398	0091 304 192	18	T54546	1328 302 111	269
T50174	1304 233 013	232	T53401	0091 304 322	17	T54547	1328 202 047	269
T50174	1297 233 059	232	T53401	0091 304 191	17	T54547	1328 202 043	269
T50176	1304 304 515	249	T53401	0091 304 372	17	T54548	1328 298 002	261
T50176	1304 304 011	249	T53401	0769 186 213	17	T54548	1328 202 040	261
T50178	1315 332 073	196	T53403	0091 304 207	230	T54548	1328 202 050	261
T50181	1304 298 910	204	T53404	0091 303 147	65	T54549	0735 330 801	52
T50369	1292 304 070	140	T53406	1311 198 401	266	T54551	0735 371 994	290
T50369	1292 304 053	140	T53410	1297 332 080	197	T54551	201052	290
T50387	0750 132 019	81	T53410	1297 332 036	197	T54551	VKHB 2067	290
T50549	1310 302 045	229	T53412	1297 332 035	182	T54551	VKHB 2249	290
T50627	0734 310 122	171	T53418	0750 132 032	300	T54551	SET 1109	290
T50679	0630 501 019	205	T53418	0501 203 684	300	T54571	1295 298 801	204
T50733	0501 204 714	54	T53418	0501 204 597	300	T54571	1295 298 932	204
T50733	0501 203 819	54	T53418	0501 396 632	300	T54606	0750 111 159	168
T50733	0732 107 001	54	T53418	1295 212 009	300	T54606	0734 319 221	168
T50736	0732 107 019	54	T53457	0501 210 058	227	T54606	0734 319 609	168
T50736	0501 206 799	54	T53457	0501 331 660	227	T54606	0750 111 424	168
T50741	0732 107 018	54	T53562	1307 202 163	125	T54637	0734 300 094	170
T50741	0501 206 800	54	T53562	1307 202 154	125	T54646	0501 398 244	82
T50741	0732 107 010	54	T53562	1307 202 140	125	T54650	0501 398 245	82
T51033	1324 298 004	264	T53644	0630 501 147	207	T54650	0501 398 216	82
T51034	1324 298 003	262	T53677	0730 061 842	174	T54656	0735 320 837	149
T51387	1297 298 800	173	T53730	0735 470 007	176	T54714	0091 303 136	73
T51388	1297 298 801	112	T53911	0730 106 561	302	T54714	1268 303 138	73



TAS no.	OEM no.	Pag.	TAS no.	OEM no.	Pag.	TAS no.	OEM no.	Pag.
T54721	1268 303 140	69	T57337	1328 302 070	120	T57493	1358 232 201	180
T54726	0091 304 062	231	T57339	1328 302 078	120	T57493	0769 171 145	180
T54731	0091 304 202	229	T57339	1328 302 071	120	T57493	1328 232 011	180
T54731	1268 304 569	229	T57353	0735 321 487	145	T57493	1328 232 016	180
T55074	1304 304 660	232	T57353	0735 301 274	145	T57493	1328 232 010	180
T55074	1304 304 056	232	T57360	1328 302 061	93	T57495	1358 332 229	178
T55145	1297 333 115	251	T57360	1329 302 004	93	T57495	1328 332 041	178
T55219	1290 395 134	234	T57366	1328 304 044	66	T57504	1358 232 013	184
T55222	1290 304 379	252	T57371	1328 302 075	196	T57504	1328 232 006	184
T55222	1290 304 343	252	T57371	1328 302 056	196	T57504	1358 232 010	184
T55355	0750 116 374	52	T57377	0735 301 881	145	T57510	1328 334 004	214
T55355	0735 330 800	52	T57377	0735 321 381	145	T57516	0501 324 368	98
T55355	0735 330 685	52	T57387	1328 304 064	216	T57516	0501 321 443	98
T55355	0735 330 614	52	T57387	1328 304 043	216	T57518	1328 301 170	79
T55355	BB1 3357	52	T57401	1314 304 119	93	T57518	1238 308 031	79
T56143	0750 115 303	154	T57421	1328 304 063	140	T57518	1238 308 165	79
T56143	0735 321 094	154	T57423	1328 304 035	136	T57520	0734 300 421	164
T56150	0750 115 327	155	T57436	1328 333 006	90	T57520	0768 800 001	164
T56157	0750 115 326	154	T57438	0730 302 523	136	T57520	0734 300 679	164
T56218	1304 304 051	251	T57438	0730 513 682	136	T57520	0769 174 312	164
T56247	0750 117 529	294	T57444	1358 332 221	198	T57529	1304 202 190	131
T56247	0750 117 332	294	T57444	1328 332 024	198	T57529	1304 302 415	131
T56247	0735 372 213	294	T57450	1358 332 222	275	T57530	1314 303 077	219
T56247	0735 370 298	294	T57450	1328 332 011	275	T57536	0501 214 822	86
T56247	0635 375 007	294	T57450	1328 332 046	275	T57536	0501 211 493	86
T56532	0501 331 906	99	T57455	1328 332 045	197	T57536	0501 211 618	86
T56534	0734 310 435	170	T57455	1328 332 009	197	T57537	1304 302 388	131
T56534	0768 800 301	170	T57455	1328 332 016	197	T57537	1304 202 177	131
T56554	0735 358 346	146	T57460	0750 118 284	55	T57538	0731 208 242	175
T56554	0735 358 333	146	T57466	1328 333 009	232	T57544	0732 042 766	224
T56554	0735 358 340	146	T57466	1328 333 004	232	T57551	1328 312 005	213
T56685	0091 303 030	47	T57473	1358 304 247	216	T57551	1314 312 018	213
T56727	0091 304 204	250	T57473	1328 304 033	216	T57557	0501 323 922	115
T56727	1268 304 554	250	T57473	1328 304 062	216	T57557	0501 319 864	115
T56734	1307 395 079	75	T57473	1328 304 068	216	T57717	1354 304 014	139
T56936	0750 117 251	288	T57475	1358 332 223	94	T57725	1354 304 015	138
T56936	0735 371 372	288	T57475	1328 332 023	94	T57798	0501 211 290	301
T56936	0735 370 513	288	T57475	1328 332 033	94	T57809	0750 117 312	291
T56940	0635 338 035	51	T57477	1358 332 244	225	T57809	0735 300 513	291
T57310	1310 303 069	73	T57477	1328 332 030	225	T58110	0630 501 050	207
T57310	1310 303 056	73	T57477	1358 332 247	225	T58316	0730 501 360	209
T57315	0501 321 451	99	T57478	TAS57478	57	T58450	1325 302 052	80
T57321	1328 302 203	162	T57479	1328 233 001	261	T58473	0730 501 598	209
T57321	1314 302 138	162	T57480	TAS57480	89	T58473	0630 501 142	209
T57325	0501 324 367	99	T57481	0730 162 804	157	T58475	1315 304 043	298
T57325	0501 321 442	99	T57487	1358 333 012	217	T58490	0501 324 670	176
T57335	1328 302 063	68	T57487	1328 333 003	217	T58498	1325 333 016	90
T57337	1328 302 077	120	T57487	1358 333 020	217	T58506	1325 334 013	211



TAS no.	OEM no.	Pag.	TAS no.	OEM no.	Pag.	TAS no.	OEM no.	Pag.
T58555	0091 302 097	126	T61001	0750 115 310	155	T64098	0750 115 427	149
T58563	0091 304 298	45	T61001	0735 321 373	155	T64098	0735 321 013	149
T58563	1268 304 559	45	T61001	0735 321 437	155	T64195	0750 117 418	293
T58569	1307 198 412	188	T61199	1304 304 672	196	T64195	0750 117 651	293
T58905	0501 215 245	161	T61274	1304 332 215	61	T64370	1325 304 223	287
T58944	1328 302 118	79	T61284	1304 332 210	60	T64456	0730 110 392	297
T59004	1304 304 637	19	T61323	1205 308 038	218	T64474	1327 304 034	220
T59009	1304 304 588	225	T61323	2050 309 066	218	T64476	1327 304 035	220
T59014	1304 303 293	23	T61346	1325 304 225	212	T64483	1327 304 036	221
T59019	1304 304 636	20	T61369	0630 531 070	208	T64683	1297 304 450	277
T59035	1304 304 604	139	T61369	0501 324 599	208	T64683	1297 304 372	277
T59041	1304 332 066	250	T61369	0630 331 070	208	T64683	1297 304 415	277
T59047	1304 304 651	250	T61510	1324 207 033	186	T65053	0501 331 587	103
T59047	1304 304 575	250	T61510	1296 207 004	186	T65053	0501 325 624	103
T59054	1304 304 576	253	T61510	1313 207 003	186	T65816	1304 403 204	161
T59073	1304 332 075	243	T61662	1328 332 022	119	T66036	0750 116 404	53
T59143	0750 115 233	145	T61735	1312 298 901	173	T66036	0750 116 197	53
T59143	0735 320 941	145	T61822	0735 370 216	294	T66265	6038 202 043	301
T59348	0750 117 892	293	T61822	0735 301 601	294	T66265	6038 202 035	301
T59348	SET 342	293	T61822	0750 117 799	294	T66265	6038 202 045	301
T59348	0750 117 210	293	T61822	0750 120 334	294	T66444	0630 501 312	206
T60218	1346 304 136	19	T62174	1314 332 043	175	T66446	0630 502 218	206
T60218	1346 304 102	19	T62175	0501 215 163	160	T66649	TAS66649	117
T60287	0091 304 054	34	T62175	5961 307 148	160	T67102	OE1307 304 175	273
T60287	0091 304 094	34	T62193	1315 221 002	121	T67103	1360 303 134	233
T60303	1304 332 111	179	T62452	1315 303 048	78	T67105	1360 304 146	232
T60303	1304 332 019	179	T62452	1315 303 022	78	T67106	1360 304 191	248
T60313	1310 304 232	229	T62465	1315 303 041	78	T67389	0501 321 148	209
T60321	1315 202 038	133	T63098	1290 304 383	277	T69054	1304 304 687	252
T60321	1315 302 164	133	T63098	1290 304 090	277	T69054	1304 304 645	252
T60321	1315 302 215	133	T63098	1290 304 190	277	T69066	0734 319 782	167
T60321	1355 302 003	133	T63098	1290 304 412	277	T69843	1315 207 014	55
T60361	1324 306 039	95	T63513	TAS63513	183	T69843	1315 207 011	55
T60361	1324 306 037	95	T63514	TAS63514	183	T69916	6002 305 994	278
T60363	1325 303 017	162	T63581	1324 207 035	186	T69916	1290 304 440	278
T60555	1327 304 015	69	T63581	1296 207 006	186	T70013	1290 302 524	123
T60555	1327 304 031	69	T63581	1313 207 005	186	T70013	1290 302 465	123
T60576	1328 302 024	86	T63588	0735 358 128	146	T70031	1304 303 291	73
T60587	0730 513 641	190	T63588	0735 358 156	146	T70037	1304 303 294	64
T60592	1314 304 097	174	T63588	0750 115 135	146	T70109	1356 204 006	265
T60646	0501 214 821	86	T63639	0730 513 862	208	T70484	1316 304 118	140
T60646	0501 211 617	86	T63639	0630 501 073	208	T70490	0501 321 459	301
T60646	0501 212 367	86	T63679	1310 302 089	120	T71619	1316 202 043	133
T60654	0501 317 289	101	T63682	1310 304 189	138	T71619	1316 302 209	133
T60686	6090 012 022	175	T63688	1310 304 161	230	T71619	1356 302 114	133
T60686	6090 012 030	175	T63688	0091 302 152	230	T72375	1290 303 221	67
T60731	1304 302 169	69	T63688	1268 302 176	230	T72388	1304 202 168	124
T60913	1304 304 516	119	T63695	1310 304 158	249	T72388	1304 202 061	124



TAS no.	OEM no.	Pag.	TAS no.	OEM no.	Pag.	TAS no.	OEM no.	Pag.
T72388	1304 202 103	124	T75240	6090 190 028	188	T77102	1346 304 039	269
T72388	1304 302 384	124	T75241	6090 199 009	188	T77102	1346 304 032	269
T72403	1308 233 003	233	T75426	1308 298 001	116	T77105	1346 304 033	268
T72403	1308 233 001	233	T75437	0734 310 230	170	T77108	1346 304 091	251
T72418	1310 302 024	235	T75473	1327 302 005	67	T77125	1308 304 087	277
T72472	1328 333 010	234	T75480	1327 302 006	69	T77125	1307 304 114	277
T72472	1314 333 031	234	T75736	1316 204 017	262	T77133	1346 304 177	94
T72781	1358 232 012	199	T75736	1316 204 015	262	T77133	1346 304 046	94
T72906	0501 209 212	55	T75736	1316 204 012	262	T77133	1346 304 119	94
T72948	0635 303 019	145	T75736	1315 298 060	262	T77141	1346 304 026	253
T72965	1315 334 074	200	T75736	1315 298 054	262	T77141	0769 171 850	253
T72965	1315 334 011	200	T75832	1324 304 050	276	T77141	1346 304 173	253
T72965	1324 334 008	200	T75832	1336 304 049	276	T77148	1346 303 038	48
T73071	0630 501 339	190	T75906	0501 215 062	163	T77148	1346 303 034	48
T73138	1310 304 178	32	T75960	TAS75960	114	T77155	1346 303 039	51
T73141	1310 304 138	42	T76007	1358 302 262	266	T77155	1346 303 033	51
T73149	1310 304 186	23	T76058	1358 202 020	270	T77186	1346 303 040	40
T73169	1290 198 406	266	T76062	1358 302 283	277	T77186	1346 303 007	40
T73206	0501 219 311	212	T76072	1358 302 261	176	T77191	1346 303 046	28
T73206	0501 217 295	212	T76138	1325 298 009	116	T77191	1346 303 029	28
T73315	TAS73315	263	T76143	1325 298 010	173	T77198	1346 203 001	74
T73344	1316 303 002	68	T76146	1325 298 011	160	T77198	1346 303 064	74
T73359	1315 233 023	191	T76149	6085 298 033	114	T77231	1310 303 059	48
T73628	1358 302 203	61	T76346	6085 298 013	113	T77244	1310 303 062	37
T73631	1358 302 224	66	T76353	6085 298 036	113	T77256	1310 303 072	26
T73634	1358 304 222	13	T76355	1310 298 018	115	T77256	1310 303 065	26
T73637	1358 304 238	9	T76659	1307 204 243	262	T77256	1310 303 078	26
T73652	1358 332 015	88	T76659	1307 204 128	262	T77268	1310 303 053	74
T73806	1316 233 028	191	T76659	1307 204 093	262	T77281	1290 304 488	229
T73806	1316 233 016	191	T76659	1307 204 084	262	T77284	1304 304 653	252
T73806	1316 233 014	191	T76666	1307 204 317	264	T77284	1304 304 697	252
T73976	TAS73976	183	T76676	1304 202 203	129	T77297	1336 304 050	230
T74139	1304 304 448	227	T76676	1304 202 115	129	T77305	1336 304 011	277
T74157	1304 332 060	182	T76676	1304 302 405	129	T77349	1336 333 001	230
T74163	1304 332 178	198	T77004	1290 302 511	123	T77355	1336 333 006	231
T74163	1304 332 059	198	T77004	1290 302 396	123	T77355	1336 333 005	231
T74170	1290 303 213	25	T77053	1327 304 024	18	T77380	1336 304 017	249
T74483	1304 302 150	64	T77053	1327 304 002	18	T77396	1336 333 004	267
T74488	1304 303 283	64	T77053	1327 304 037	18	T77628	1304 304 582	14
T74493	1324 303 007	67	T77058	1327 304 032	140	T77641	1304 303 292	13
T74495	1324 303 018	29	T77058	1327 304 025	140	T77648	0750 115 430	150
T74495	1324 303 008	29	T77074	1328 302 062	65	T77648	0735 321 169	150
T74498	1324 304 009	19	T77080	1346 302 047	123	T78294	0735 295 223	60
T74672	1307 298 001	262	T77087	1346 304 048	49	T78301	1346 298 005	265
T74672	1307 204 266	262	T77091	1346 304 099	32	T78305	0750 115 565	147
T75012	1290 298 905	114	T77095	1346 304 054	14	T78305	0735 321 580	147
T75033	0730 063 154	190	T77095	1346 304 011	14	T78305	0735 321 588	147
T75057	0501 322 825	98	T77099	1346 304 092	233	T78313	0750 115 566	150



TAS no.	OEM no.	Pag.	TAS no.	OEM no.	Pag.	TAS no.	OEM no.	Pag.
T78313	0735 321 581	150	T81270	1290 395 021	228			
T78313	0735 321 589	150	T81271	1290 395 013	230			
T78320	0750 115 567	152	T81272	1290 304 380	249			
T78320	0735 321 582	152	T81272	1290 304 180	249			
T78320	0735 321 590	152	T81272	1290 304 411	249			
T78329	1346 298 003	263	T81474	1297 298 955	261			
T78329	1346 204 002	263	T81644	1329 304 010	14			
T78431	1328 298 001	263	T81645	1329 304 007	9			
T78431	1328 202 049	263	T82032	1358 202 022	287			
T78431	1328 202 039	263	T82036	1358 298 029	287			
T78431	1328 202 016	263	T84569	1304 204 059	263			
T78683	TAS78683	87	T84569	1290 204 075	263			
T78743	0501 327 837	103	T84569	1290 204 079	263			
T78748	0501 331 264	111	T85132	1304 304 630	141			
T78819	1358 304 253	217	T85251	0501 316 270	60			
T78994	0501 329 501	111	T85574	1336 302 010	187			
T79144	1358 303 222	218	T85645	TAS49334	163			
T79150	0501 219 105	86	T93563	1307 395 192	232			
T79969	6093 304 079	210	T93563	1307 304 574	232			
T80182	1308 303 027	29	T93807	8098 633 003	173			
T80212	1308 303 023	68	T93807	8098 633 014	173			
T80220	1310 303 076	75	T93807	8098 633 001	173			
T80220	1310 203 001	75	T93874	1315 298 001P	116			
T80220	1310 303 021	75	T94081	1315 202 071	131			
T80238	1297 338 010	91	T94081	1355 302 014	131			
T80245	0501 321 879	98	T94247	TAS94247	200			
T80286	0634 349 645	169	T94368	TAS94368	87			
T80289	1290 298 920	172	T94385	1315 202 070	134			
T80296	1315 334 041	177	T94385	1355 302 012	134			
T80301	1308 232 007	185	T94436	0501 324 254	81			
T80341	1308 304 059	226	T94453	TAS94453	183			
T80344	1311 302 022	228	T94456	1315 305 005	192			
T80347	1346 304 021	249	T94563	TAS94563	113			
T80358	1308 332 015	278	T94566	TAS94566	114			
T80504	1316 204 011	264	T94569	TAS94569	111			
T80504	1315 298 055	264	T94572	TAS94572	114			
T80878	1325 298 008	264	T94575	TAS94575	112			
T80878	1316 298 037 MO	264						
T80878	1315 298 008	264						
T81195	1304 304 586	9						
T81205	1268 304 287	43						
T81209	1304 232 051	185						
T81217	1308 202 052	125						
T81217	1308 202 038	125						
T81217	1308 302 096	125						
T81218	1310 302 026	125						
T81230	1269 304 060	141						
T81265	1327 304 033	212						



**GEARBOX AND DIFFERENTIAL**  
SPARE PARTS



**GEARBOX AND DIFFERENTIAL  
SPARE PARTS**

**Head Office**

Via Argine, 306  
80147 Napoli, Italy  
Tel.: +39 081 7520645  
Fax: +39 081 7529475

**Production unit**

Via dell'Industria, 1  
40050 Argelato (BO), Italy  
Tel.: +39 051 758154  
Fax: +39 051 732707

email: [web@tas-spa.com](mailto:web@tas-spa.com)



[www.tas-spa.com](http://www.tas-spa.com)

